

Pendant

Quick Reference

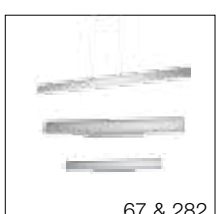

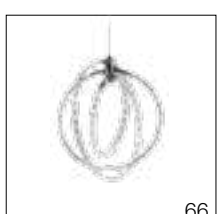
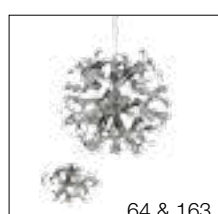
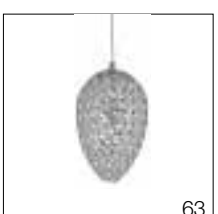
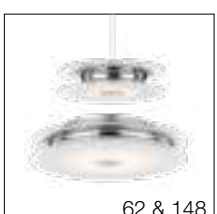
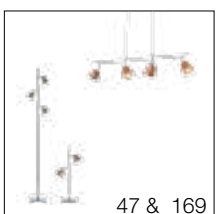
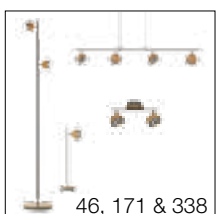
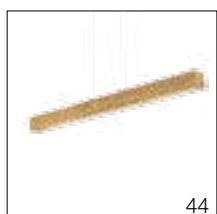

71



72



73



74



75



76

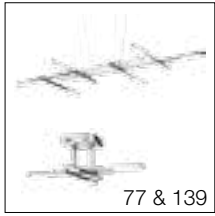

77 & 139



79



80 & 81

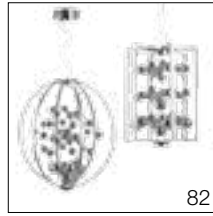

82



83



85



86



87



88



89



91



92



93



94



95



97



98



99



100

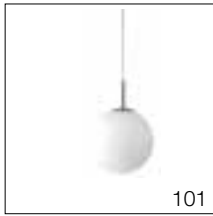

101



102

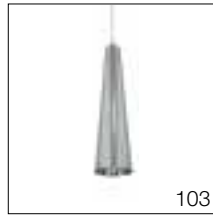

103



105 & 235

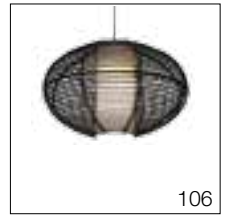

106



107



108 & 182

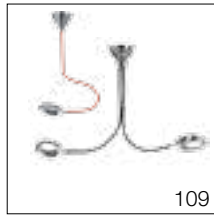

109



111

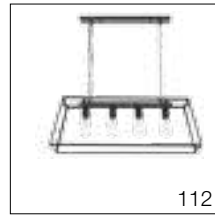

112

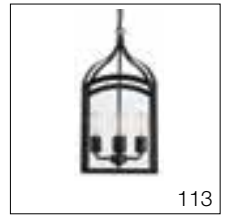

113



114



115



117



118



119



120



121



122



123

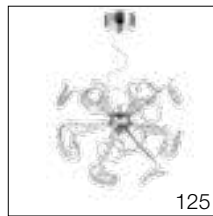

125



126



127



128 & 308



129



130

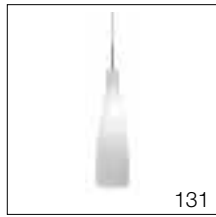

131

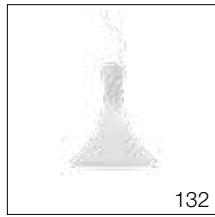

132



133

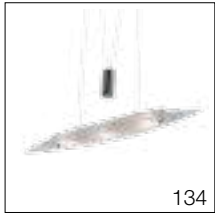

134

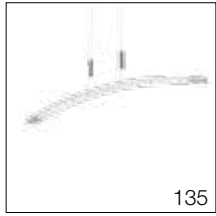

135



136

CTC

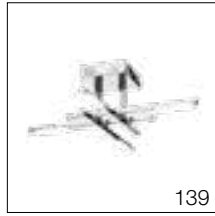

139



140



141



142



143

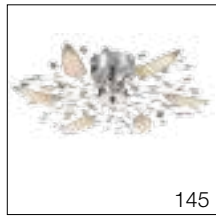

145

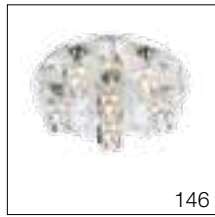

146

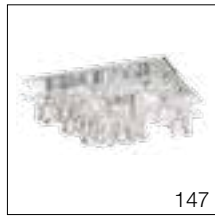

147



148

Batten Fix



150



151



152



153



154



155



157



158



159



160



161

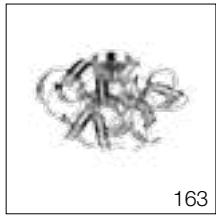

163



164



165



166

Floor & Table Lamp

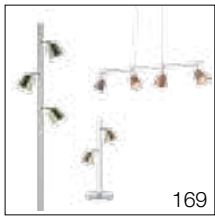

169



170

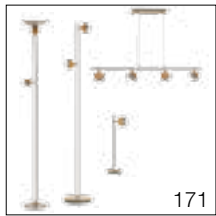

171



172



173



174

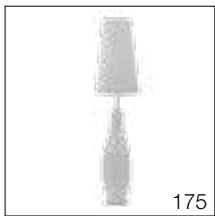

175

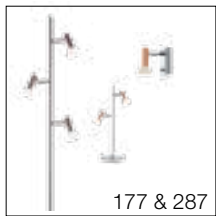

177 & 287



178

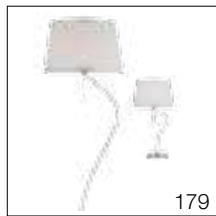

179



180



181

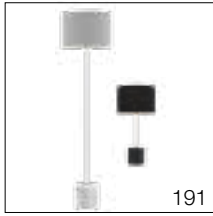
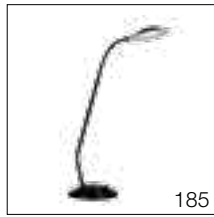

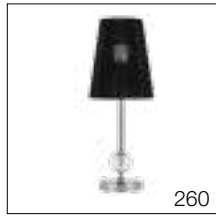
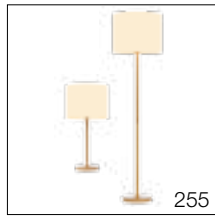
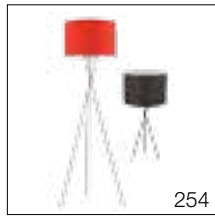
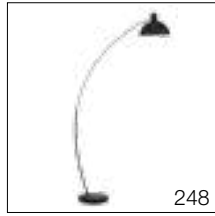
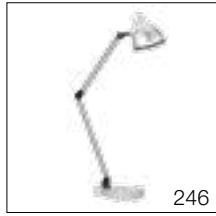

Abode Series 272
Shades 273-276

Wall
Lamp/
Vanity

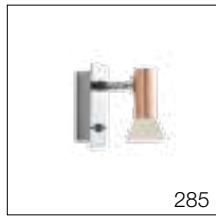
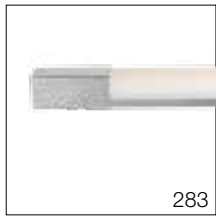
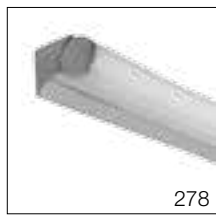



295

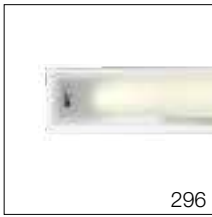

296



297



298



299



300



301



303



304



305



306



307



308



309



310



311



312



313



314

Oyster



317



318



319



320



321



322



323



324



325



326



327



328



329



330



331



332



333



334



335



336

Spot-light



338



339



340



341



342



343



344

Down-light

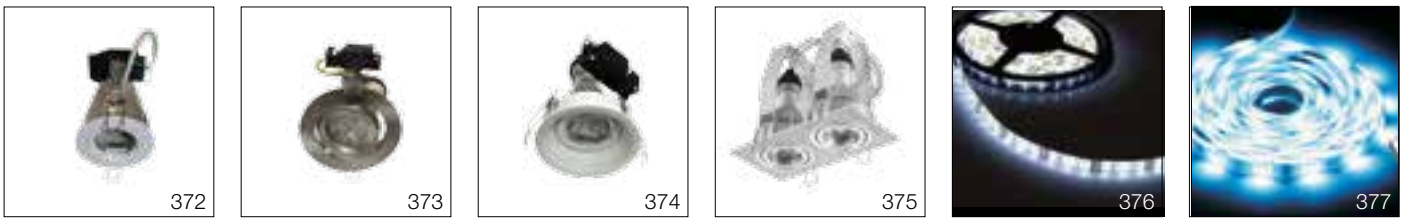
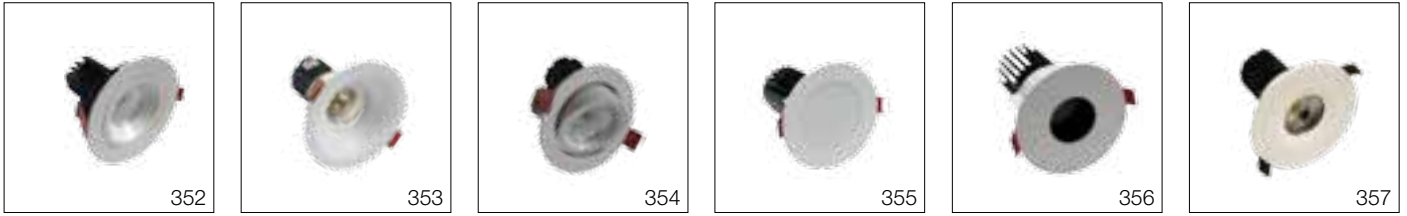

Exterior

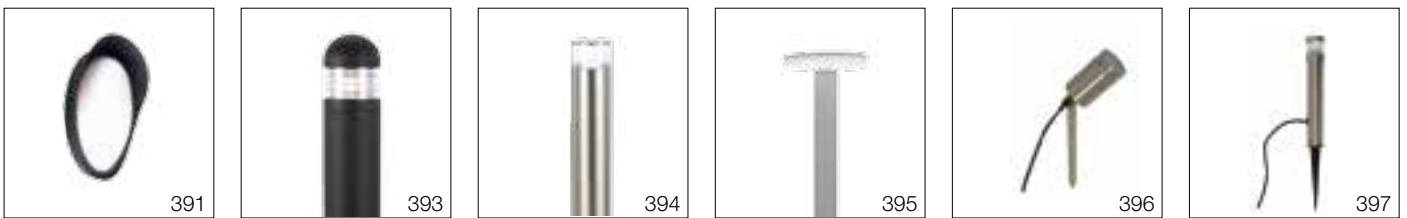



398



399



400



401



403



404



405



406



407



408



409



410



411



413



414



416



417



418

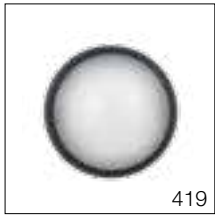

419



420



421



422



423



424



425



426



427



428



429



430-431



432



434



435



436



437

Globe



438



439



440



441



442



443



444



445

Index

301/303 GU10	373	Axis	207	Cob 6	437
301/303 GU10 Guard	372	Baja	245	Cob 8	437
Abode Series	272	Bally	101	Cobpro	358
Adair	226-227	Balon	76	Colly	27
Adam	259	Bart	244	Conley	432
Acento	318	Bass	427	Coote	86
Adria	222	Baxter	228	Cordia	67, 282
Aero	333	Beat	248	Cosi	236
Agora	193	Bee	72,153	Cosmic	75-76
Akard	387	Belmore	178	Covina	264-265
Akota	54-55	Benton	394	Dale	174
Alain	48-49	Beliza	293	Daro	371
Alberg	344	Bella	323	Davis	386
Albion	395	Berlin	314	Deck lights remote	412-413
Alden	116-117	Bingo	66	Deck lights	414
Alec	39	Biscay	262	Delphi	94
Alpha GU10	375	Bisset	132	Denali	416
Alwin	384	Blade	336	Denby	62,148
Amani	205	Bloc	418	Denise	254
Andra	420	Bolle	123	Diana	266
Andy	32	Bomp	256-257	Dino	166
Angus	271	Bortoli	80-81, 324	Diva	130
Anita	166	Bosco	206	Dixon	426
Apex	246	Boston	238	Domain	399
App	150	Botega	131	Dono	217
Arden	342	Brent	398	Dorian	250-251
Aragon	84-85	Bresno	92	Dramas	26
Arcadia	103	Brest	27	Dream	124-125
Argenta	183	Briar	424	Dubai	316-317
Aries	159	Brit	68-69	Durum	273
Aria	297	Bruno	42	Dutch	158
Arkos	190-191	Burton	339	E14 halogen	439
Arlene	231	Byron	328	Eden	224
Aron	422	Cabinet round	378	Edith	142
Aros	52	Camillia	141	Edrik	47, 168-169
Artis	110-111	Carbon	275	Edson	241
Assan	58	Cascade	83	Ekland	30
Astrid	326-327	Catino	118	Elton	380-381
Atone	121	Chantel	82	Elba	278
Atrium	405	Charles	390	Elsa	287
Austin	404	Chelsea	128, 308	Emily	255
Axel	281	Chloe	93	Endo	423

Envoy	165	Haig	129	LED RGB kit	376
Enya	70	Haly	166	LED stripe	377
Eos	421	Harbor	392-393	Lenti	25
Epoca	144-145	Hertel	56, 170	Lessa	309
Erin	166	Heston	280	Ling	213
Esmo	208	Hildy	233	Loop	27
Ethan	391	Holger	239	Loreto	232
Etra	24	Hulong	211	Luk	151
Eva	126	Hurst	406	Lusa	319
Evan	320	Ibiza	113	Lydia	165
Evelyn	263	Illume	408	Magneto	410
Fancy round	436	Incandescent Flame	440	Mainz	53
Farina ball	37	Jacky	42	Maluka	107
Farina	36	Jasmine	261	Mardi	258
Fargo	300	JC G4	441	Marina	335
Felipa	237	Jet	330	Marisa	319
Festa	304	Jill	38	Marion	51
Filament candle globe	436	Jonah	210	Market	18
Filament pilot globe	435	Joy	253	Master	334
Fiona	22-23, 249	June	186	Mason	88
Fitch	115	Kadro	50	Mateo	295
Flat 90	362	Kamoto	133	MDL 16	346-347
Flat 100	363	Kaos	19	MDL 403	348
Flip	411	Kate	166	MDL 501	349
Flora	274	Kay	102	MDL 503	350
Flow	42	Keller	75	MDL 601	351
Flyn	209	Keras	136	MDL 603	352
Foil	20	Kerry	407	MDL 611	353
Fonda	179	Ketu	109	MDL 703	354
Forum	247	Kim	283	MDL 801	355
Fredi	34-35	Kirk	299	MDL 901	356
Futura	134	Kibo	302-303	Merino	64,162-163
G9 Halogen	441	Korpi	184-185	Merlin	33,189
G9 LED	438	Kotos	397	Merak	310
Gibson	305	Kumi	340	Miki	135
Giro	98	Kuran	46, 171, 338	Milo	194
Glade	260	Kyo	385	Mina	112
Glim	325	Lacey	275	Miren	202
Global	331	Lang	71	Misha	108, 182
Grace	160	Lantau	214	Molera	229
Graf	14-15	Largo	114	Mondo	99
Grove	306	Lea	127	Moody	119
GU10 halogen	439	Lecona	95	Moritz	187
GU10 SMD	442	LED Filament globe	435	Morley	389

Move	382	Rashid	60-61	Tamar	195
MR11 SMD	442	Rebus	388, 396	Tarakan	106
Nakato	212	Regina	225	Taso	374
Napa	43	Regus	175	Taylor	321
Nara	370	Remy	43	Teca	156-157
Nashi	216	Revo	361	Tetris	77,138-139
Nemo	292	Riley	322	Tigra	74
Neta	199	Riva	430	Titan	409
Neve	63	Riva LED	431	Tito	96-97
Nicola	65	Roland	425	Toffi	45
Noni	100	Ronan	28-29	Toledo	192
Norvel	116-117	Rondo	360	Tolosa	73, 341
Offect	429	Rotary 12	368	Toll	301
Ohio	268	Rotary 15	369	Tommy	165
Olga	198	S4 Globe	444	Tonty	122
Oliver	172	Sala	240	Tora	400
Olsen	164	Sally	146	Tornado 16	366
Oma	152	Sandy	267	Tornado 20	367
Opus 105	357	Satin	274	Tornado G2 30	364
Orson	200-201	Sax	269	Tornado G2 40	365
Oras	279	Seattle	87	Torres	270
Oska	307	Selma	197	Tribe	104-105, 234-235
Otis	59	Sempre	57	Trill	311
Oxford	252	Sensor	402-403	Turn	383
Padma	203	Serax	181	Tyler	242-243
Panel	359	Seville	140	Umbo	294
Panto	196	Shani	204	Unos	329
PAR 6W	440	Shelta	332	Venato	31
Parkin	298	Shibo	215	Vertigo	82
Peg	313	Sibel	312	Vess	72,155
Pelare	428	Sigrid	220	Vesta	416
Pena	176-177, 284-285	Slice	286	Virgil	173
Penrith	147	Snap	291	Vivian	218-219
PL2 Fluorescent	443	Soft	273	Watson	180
Plaza	230	Sole	72,154	Wave	296
Polk	16-17	Sonya	40-41	Whitney	223
Prefet	21	Spline	188	Wilton	221
Prima	401	Status	343	Wynn	419
Puk	445	String	276	Yomo	89
Puka	290	Stow	288-289	Zucchi	120
Pye	434	Sven	44		
Quad	276	T5 Linear Fluorescent	444		
Rachel	90, 161	T5R Fluorescent	443		
Ramon	143	T8 9w/18w	438		

Pendant





Graf

Pendant



Specifications

Type	Pendant
Light Source	E14 25w max
Globe	Not included
Warranty	1 year*

Colours

Chrome/Canadian ash timber



Measurements

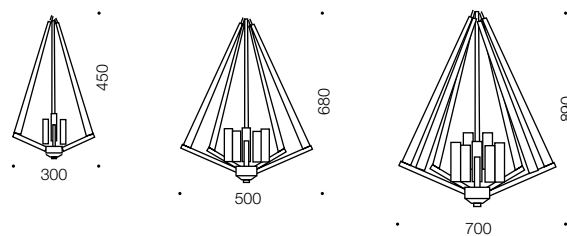

Cable Length: 2.0

Codes

Graf PE3-CH-ASH

Graf PE5-CH-ASH

Graf PE8-CH-ASH

Product Approvals



Polk

Pendant



Specifications

Type	Pendant
Light Source	E27 25w max
Globe	Not included
Warranty	1 year*

Measurements

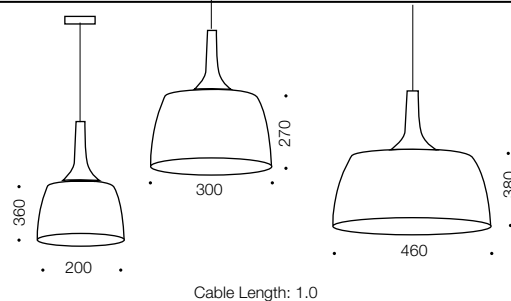

Colours

Oak/white



Oak/black



Codes

Polk PE20-OK/BK

Polk PE20-OK/WH

Polk PE30-OK/BK

Polk PE30-OK/WH

Polk PE46-OK/BK

Polk PE46-OK/WH

Product Approvals



Polk

Pendant



Specifications

Type	Pendant
Light Source	E27 40w max
Globe	Not included
Warranty	1 year*

Colours

Black/copper



Measurements

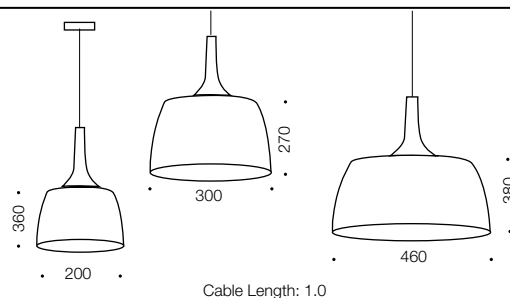

Codes

Polk PE20-BK/CP

Polk PE30-BK/CP

Polk PE46-BK/CP

Product Approvals



Market

Pendant



Specifications

Type	Pendant
Light Source	E27 40w max
Globe	Not included
Warranty	1 year*

Measurements

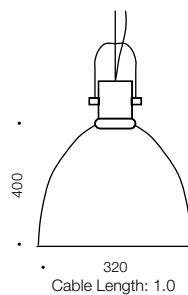

Colours

Chrome/copper

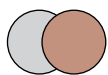

Codes

Market PE31-CH

Market PE31-CP

Product Approvals



Kaos

Pendant



Specifications

Type	Pendant
Light Source	E27 40w max
Globe	Not included
Warranty	1 year*

Colours

Chrome/copper

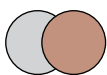

Measurements

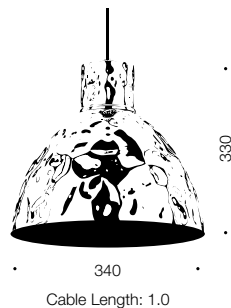

Codes

Kaos PE34-CH

Kaos PE34-CP

Product Approvals

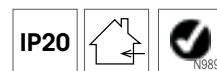

Foil

Pendant



Specifications

Type	Pendant
Light Source	E27 25w max
Globe	Not included
Warranty	1 year*

Measurements

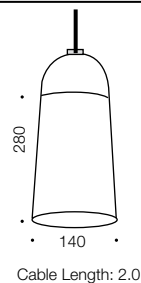

Colours

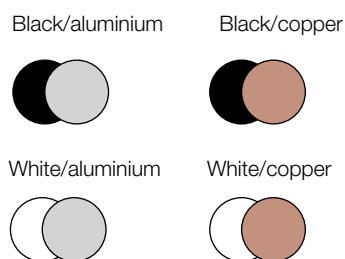

Codes

Foil PE14-BKAL

Foil PE14-BKCP

Foil PE14-WHAL

Foil PE14-WHCP

Product Approvals



Prefet

Pendant



Specifications

Type	Pendant
Light Source	LED
Lumen	320
Colour Temp	4000k
Wattage	4w GU10s4
Dimmable	No
CRI	79
Power Factor	>0.5
Beam Angle	50
Warranty	2 year*

Colours

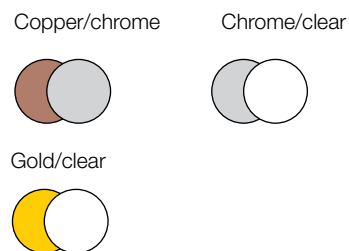

Codes

Prefet PE-CH

Prefet PE-CP

Prefet PE-GD

Measurements

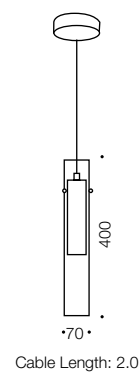

Product Approvals





Fiona

Pendant



Specifications

Type	Pendant, Floor & Table Lamp
Light Source	E27 40w max
Globe	Not included
Warranty	1 year*

Colours

Oak/white-nickel



Measurements

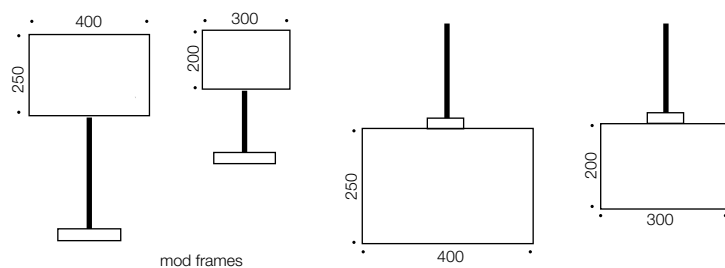

Cable Length: 2.0

Codes

Fiona PE30-OAKWH

Fiona PE40-OAKWH

Fiona TL30-OAKWH

Fiona TL40-OAKWH

Fiona FL30-OAKWH

Fiona FL40-OAKWH

Product Approvals

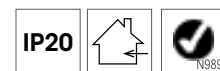

Etra

Pendant



Specifications

Type	Pendant
Light Source	G9 28w HAL
Globe	Included
Warranty	1 year*

Colours

Clear/chrome

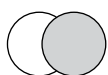

Measurements

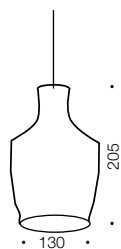

Cable Length: 2.0

Codes

Etra PE-CL

Product Approvals



Lenti Pendant



Specifications

Type	Pendant
Light Source	G9 28w HAL
Globe	Included
Warranty	1 year*

Colours

Clear/chrome

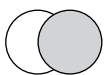

Measurements

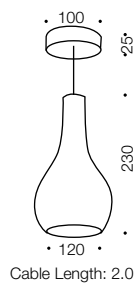

Codes

Lenti PE-CL

Product Approvals



Dramas

Pendant



Specifications

Type	Pendant
Light Source	E27 40w max
Globe	Not included
Warranty	1 year*

Measurements

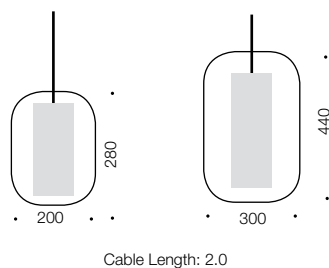

Colours

Clear/marble/nickel



Codes

Dramas PE20-CLVM

Dramas PE30-CLVM

Product Approvals



Loop, Brest & Colly

Pendant



Specifications

Type	Pendant
Light Source	E27 40w max
Globe	Not included
Warranty	1 year*

Colours

Clear/chrome

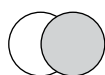

Measurements

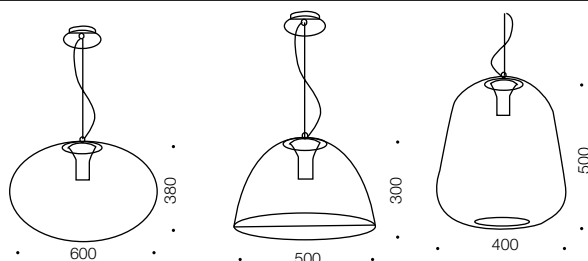

Cable Length: 2.1

Codes

Loop PE60-CL

Brest PE50-CL

Colly PE40-CL

Product Approvals





Ronan

Pendant



Specifications

Type	Pendant
Light Source	E27 25w max
Globe	Not included
Warranty	1 year*

Measurements

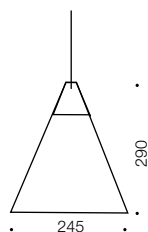

Cable Length: 2.0

Colours

Grey/oak



Rusty/oak



White/oak



Codes

Ronan PE25-GY

Ronan PE25-RT

Ronan PE25-WH

Product Approvals

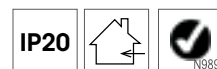

Ekland

Pendant



Specifications

Type	Pendant
Light Source	E27 25w max
Globe	Not included
Warranty	1 year*

Measurements

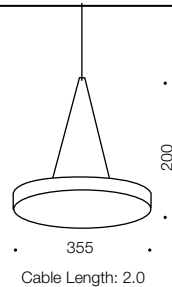

Colours

Grey/oak



Rusty/oak



White/oak



Codes

Ekland PE35-GY

Ekland PE35-RT

Ekland PE35-WH

Product Approvals



Venato

Pendant



Specifications

Type	Pendant
Light Source	E27 25w max
Globe	Not included
Warranty	1 year*

Measurements

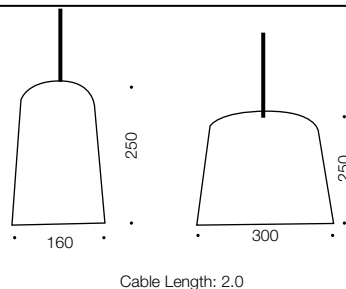

Colours

White/marble



Codes

Venato PE16-WM

Venato PE30-WM

Product Approvals

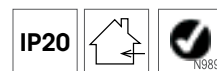

Andy Pendant



Specifications

Type	Pendant
Light Source	E27 25w max
Globe	Not included
Warranty	1 year*

Colours

Chrome/opal

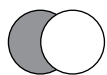

Measurements

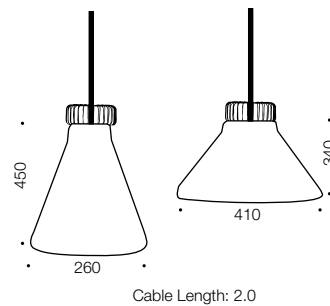

Codes

Andy PE26-CHOP

Andy PE41-CHOP

Product Approvals

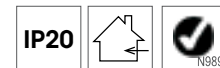

Merlin

Pendant & Table Lamps



Specifications

Type	Pendant
Light Source	LED
Lumen	350/1200
Colour Temp	4000k
Wattage	5w/18w
Dimmable	No
CRI	>80
Power Factor	>0.9
Beam Angle	120
Warranty	2 year*

Colours

Copper/chrome

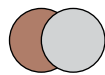

Brass/chrome

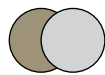

Nickel/chrome

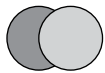

Codes

Merlin PE20-CP Merlin PE40-CP

Merlin PE20-NK Merlin PE40-NK

Merlin PE20-PB Merlin PE40-PB

Merlin TL-CP Merlin TL-NK

Merlin TL-PB

Measurements

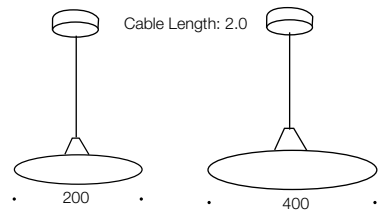

Product Approvals

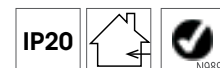



Fredi Pendant



Specifications

Type	Pendant
Light Source	E27 25w max
Globe	Not included
Warranty	1 year*

Colours

Grey/nickel



Measurements

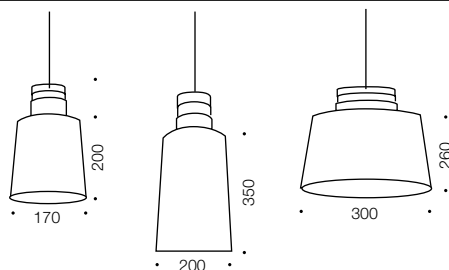

Cable Length: 2.0

Codes

Fredi PE17-GY

Fredi PE20-GY

Fredi PE30-GY

Product Approvals



Farina

Pendant



Specifications

Type	Pendant
Light Source	E27 25w max
Globe	Not included
Warranty	1 year*

Colours



Measurements

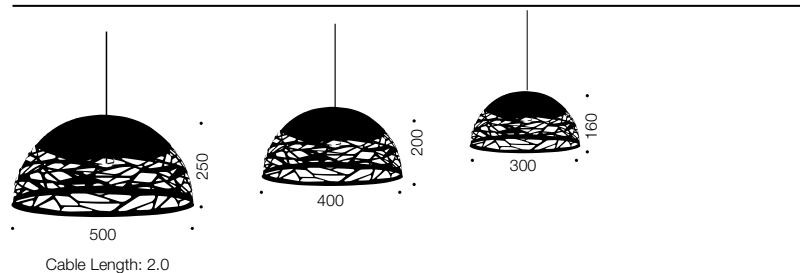

Codes

Farina PE30-BK	Farina PE40-BK
Farina PE30-BZ	Farina PE40-BZ
Farina PE30-WH	Farina PE40-WH
Farina PE50-BK	
Farina PE50-BZ	
Farina PE50-WH	

Product Approvals



Farina Ball

Pendant



Specifications

Type	Pendant
Light Source	E27 25w max
Globe	Not included
Warranty	1 year*

Measurements

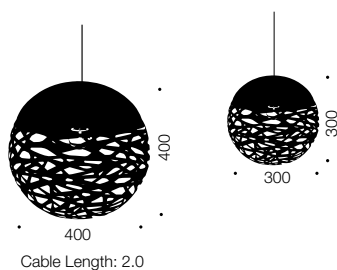

Colours



Codes

Farina PEB30-BK

Farina PEB30-BZ

Farina PEB30-WH

Farina PEB40-BK

Farina PEB40-BZ

Farina PEB40-WH

Product Approvals



Jill

Pendant



Specifications

Type	Pendant
Light Source	E27 40w max
Globe	Not included
Warranty	1 year*

Colours

Black/white with oak

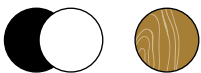

Measurements

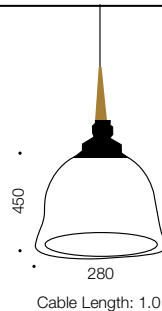

Codes

Jill PE-BK

Jill PE-WH

Product Approvals



Alec

Pendant



Specifications

Type	Pendant
Light Source	E27 40w max
Globe	Not included
Warranty	1 year*

Colours

Black/white with oak

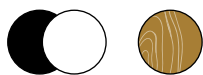

Measurements

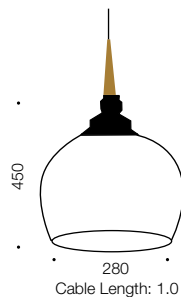

Codes

Alec PE-BK

Alec PE-WH

Product Approvals





Sonya

Pendant



Specifications

Type	Pendant
Light Source	E27 40w max
Globe	Not included
Warranty	1 year*

Measurements

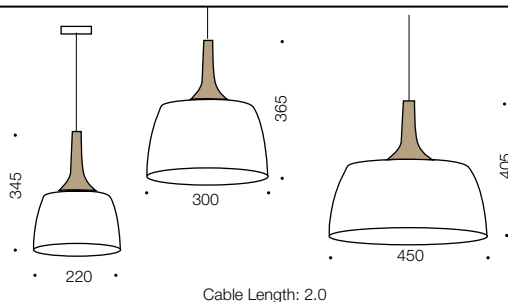

Colours

Blue/oak



White/oak



Bronze/oak



Codes

Sonya
PE22-BLOK

Sonya
PE22-BZOK

Sonya
PE22-WHOK

Sonya PE30-BLOK

Sonya PE30-BZOK

Sonya PE30-WHOK

Sonya
PE45-BLOK

Sonya
PE45-BZOK

Sonya
PE45-WHOK

Product Approvals



Bruno, Jacky & Flow

Pendant



Specifications

Type	Pendant
Light Source	E27 40w max
Globe	Not included
Warranty	1 year*

Colours

Clear/oak



Measurements

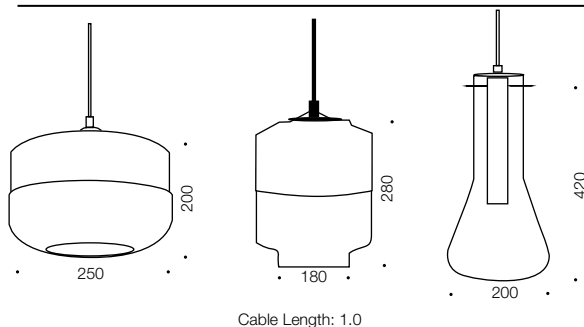

Codes

Bruno PE25-CL/OK

Jacky PE18-CL/OK

Flow PE20-CL/OK

Product Approvals



Napa & Remy

Pendant



Specifications

Type	Pendant
Light Source	E27 40w max
Globe	Not included
Warranty	1 year*

Colours

Nickel/clear/hemp



Measurements

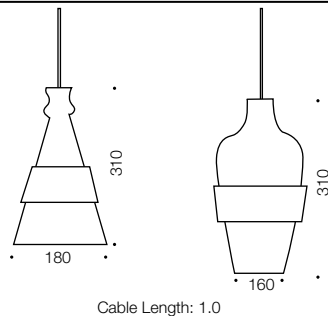

Codes

Napa PE-NK/CL

Remy PE-NK/CL

Product Approvals

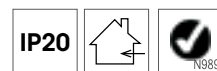

Sven

Pendant



Specifications

Type	Pendant
Light Source	LED
Lumen	1950
Colour Temp	4000k
Wattage	24w
Dimmable	Yes
CRI	80
Power Factor	>0.9
Beam Angle	120
Warranty	2 year*

Colours

Oak/walnut



Measurements

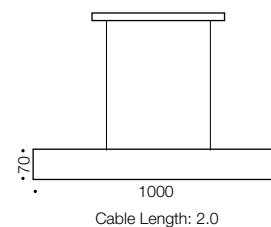

Codes

Sven PE-OAK

Sven PE-WAL

Product Approvals



Toffi

Pendant



Specifications

Type	Pendant
Light Source	GU10s
Lumen	320/1280/1600
Colour Temp	4000k
Wattage	4w /4x4w/ 5x4w
Dimmable	No
CRI	>80
Power Factor	>0.9
Beam Angle	140
Warranty	2 year*

Colours

Chrome/clear

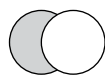

Gold/clear

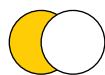

Measurements

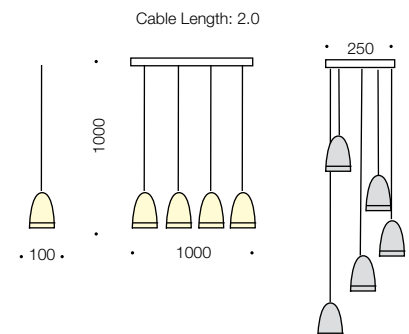

Codes

Toffi PE1-CH	Toffi PE1-GD
Toffi PE4B-CH	Toffi PE4B-GD
Toffi PE5R-CH	Toffi PE5R-GD

Product Approvals



Kuran

Pendant, Spot, Floor & Table Lamp



Specifications

Type	Pendant
Light Source	LED
Lumen	350 per head
Colour Temp	4000k
Wattage	4x4w
Dimmable	No
CRI	>80
Power Factor	>0.9
Beam Angle	120
Warranty	2 year*

Colours

Oak/nickel

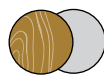

Codes

Kuran 4P-OAK

Kuran FL-OAK

Kuran FL.M&S-OAK

Kuran FL2-OAK

Kuran TL-OAK

Kuran 1R-OAK Kuran 2B-OAK

Kuran 3B-OAK Kuran 4B-OAK

Measurements

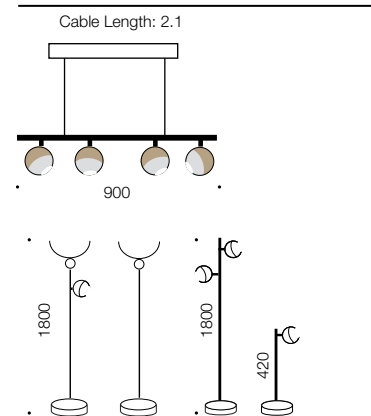

Product Approvals



Edrik

Pendant, Floor & Table Lamp



Specifications

Type	Pendant, Floor & Table Lamp
Light Source	LED
Lumen	1400
Colour Temp	4000k
Wattage	4 x 5w
Dimmable	No
CRI	79
Power Factor	>0.9
Beam Angle	120
Warranty	2 year*

Colours

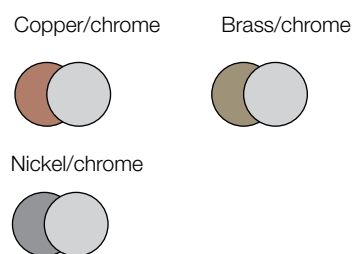

Codes

Edrik PE 4-CP	
Edrik PE 4-NK	
Edrik PE 4-PB	
Edrik FL 3-CP	Edrik TL 2-CP
Edrik FL 3-NK	Edrik TL 2-NK
Edrik FL 3-PB	Edrik TL 2-PB

Measurements

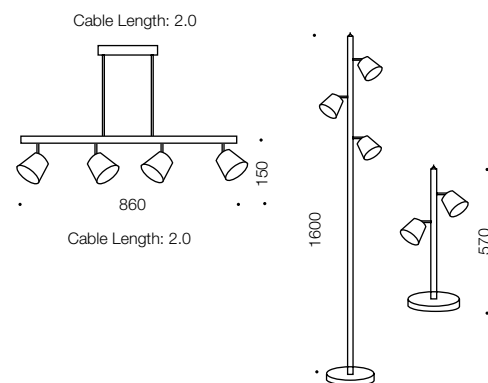

Product Approvals

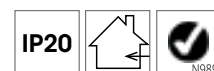



Alain

Pendant



Specifications

Type	Pendant
Light Source	E27 40w max
Globe	Not included
Warranty	1 year*

Colours

Chrome/vanilla

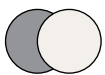

Gold/vanilla

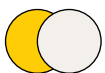

Copper/vanilla

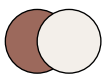

Measurements

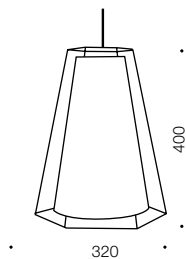

Cable Length: 2.0

Codes

Alain PE32-CHVN

Alain PE32-CPVN

Alain PE32-GDVN

Product Approvals



Kadro

Pendant



Specifications

Type	Pendant
Light Source	E27 40w Pilot Vintage filament
Globe	Included
Warranty	1 year*

Colours

Oil bronze/antique brass

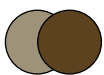

Measurements

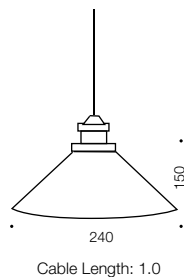

Codes

Kadro PE-OB

Product Approvals



Marion

Pendant



Specifications

Type	Pendant
Light Source	E27 Pilot 40w
Globe	Included
Warranty	1 year*

Colours

Chrome/clear



Antique brass/clear



Copper/clear

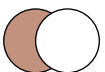

Oil bronzel/clear



Measurements

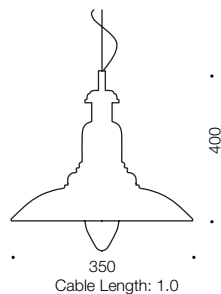

Codes

Marion PE-AB

Marion PE-CH

Marion PE-CP

Marion PE-OB

Product Approvals



Aros

Pendant



Specifications

Type	Pendant
Light Source	25w Pilot Vintage filament
Globe	Included
Warranty	1 year*

Colours

Gunmetal



Measurements

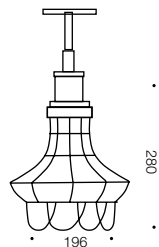

Cable Length: 1.0

Codes

Aros PE1-GM

Product Approvals



Mainz

Pendant



Specifications

Type	Pendant
Light Source	E27 25w max
Globe	Not included
Warranty	1 year*

Colours

Copper matt/
opal matt

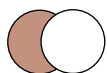

Nickel/
opal matt

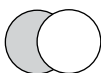

Oil bronze/opal matt



Measurements

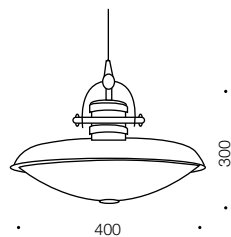

Cable Length: 1.0

Codes

Mainz PE40-CP

Mainz PE40-NK

Mainz PE40-OB

Product Approvals





Akota

Pendant



Specifications

Type	Pendant
Light Source	E14 25w max E27 25w max
Globe	Not included
Warranty	1 year*

Colours

Black/amber



Measurements

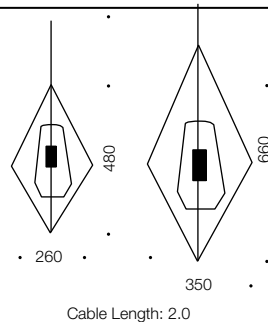

Codes

Akota PE26-BKAM

Akota PE35-BKAM

Product Approvals

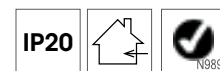

Hertel

Pendant, Floor & Table Lamp



Specifications

Type	Pendant, Floor & Table Lamp
Light Source	E27 25w max
Globe	Not included
Warranty	1 year*

Colours

Black/amber



Measurements

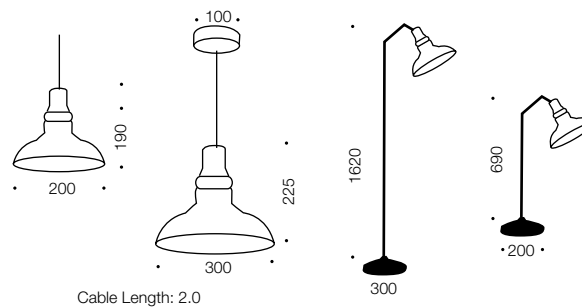

Codes

Hertel PE20-BKAM

Hertel PE30-BKAM

Hertel FL-BK/AM

Hertel TL-BK/AM

Product Approvals

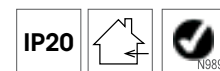

Sempre

Pendant



Specifications

Type	Pendant
Light Source	E27 25w max
Globe	Not included
Warranty	1 year*

Measurements

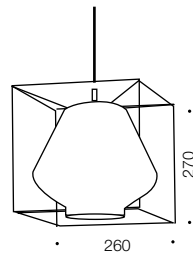

Cable Length: 2.0

Colours

Black/amber



Black/clear



Codes

Sempre PE26-BKAM

Sempre PE26-BKCL

Product Approvals

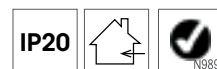

Assan

Pendant



Specifications

Type	Pendant
Light Source	E27 25w max
Globe	Not included
Warranty	1 year*

Colours

Black/white



Measurements

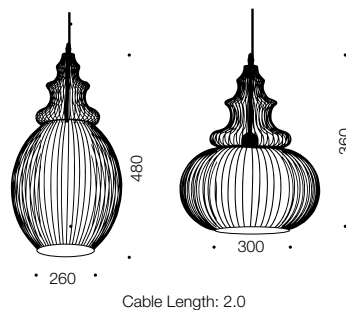

Codes

Assan PE26-BK

Assan PE30-BK

Product Approvals



Otis

Pendant



Specifications

Type	Pendant
Light Source	E27 40w max
Globe	Not included
Warranty	1 year*

Colours

Chrome-clear/
chrome

Gold-clear/gold



Measurements

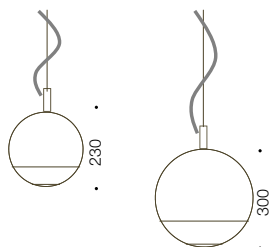

Codes

Otis PE23-CH

Otis PE23-GD

Otis PE30-CH

Otis PE30-GD

Product Approvals





Rashid

Pendant



Specifications

Type	Pendant
Light Source	E27 25w max
Globe	Not included
Warranty	1 year*

Colours

Black/cream



Measurements

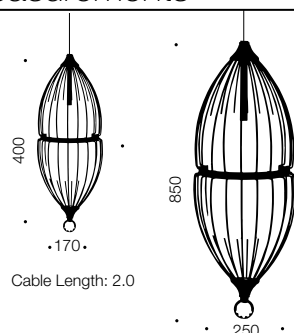

Codes

Rashid PE17-BK

Rashid PE25-BK

Product Approvals



Denby

Pendant & CTC



Specifications

Type	Pendant & CTC
Light Source	LED
Lumen	300/740
Colour Temp	4000k
Wattage	5w/12w
Dimmable	No
CRI	>80
Power Factor	>0.9
Beam Angle	120
Warranty	2 year*

Colours

Chrome/opaline



Measurements

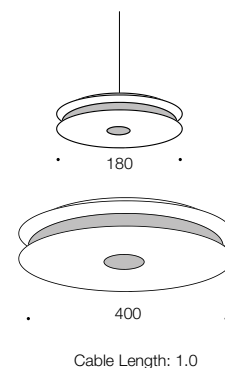

Codes

Denby PE5-CH

Denby CTC12-CH

Product Approvals

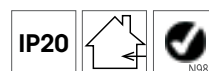

Neve

Pendant



Specifications

Type	Pendant
Light Source	G9 33w ORSAM
Globe	Included
Warranty	1 year*

Colours

Chrome/optic crystal

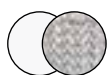

Measurements

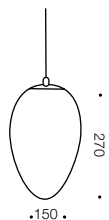

Cable Length: 1.0

Codes

Neve PE15-CH

Product Approvals



Merino

Pendant & Batten Fix



Specifications

Type	Pendant & BF
Light Source	G9 28w max
Globe	Included
Warranty	1 year*

Measurements

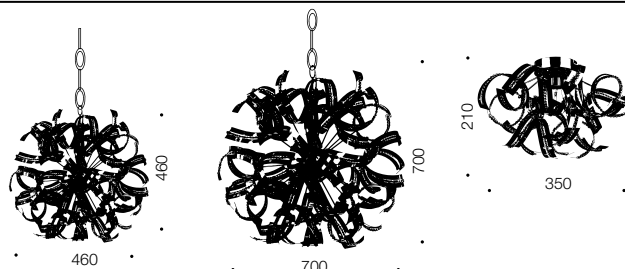

Colours

Chrome/glass

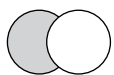

Codes

Merino PE5-CH

Merino PE8-CH

Merino BF-CH

Product Approvals



Nicola

Pendant



Specifications

Type	Pendant
Light Source	G9 33w ORSAM
Globe	Included
Warranty	1 year*

Colours

Chrome/crystal



Measurements

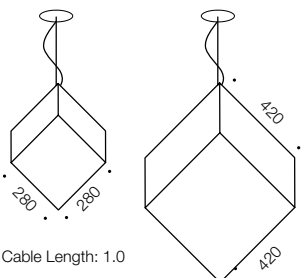

Codes

Nicola PE4-CH

Nicola PE7-CH

Product Approvals



Bingo

Pendant



Specifications

Type	Pendant
Light Source	LED
Lumen	1700
Colour Temp	4000k
Wattage	21w SMD
Dimmable	No
CRI	>80
Power Factor	>0.9
Beam Angle	120
Warranty	2 year*

Colours

Chrome/crystal

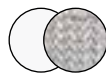

Codes

BINGO PE21-CH

Measurements

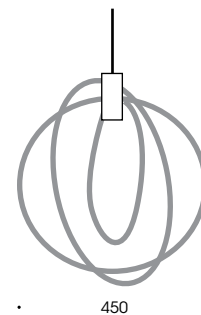

Cable Length: 1.0

Product Approvals



Cordia

Pendant & Wall Lamp



Specifications

Type	Pendant & Wall Lamp
Light Source	LED
Lumen	2000
Colour Temp	4000k
Wattage	25w
Dimmable	Yes
CRI	>80
Power Factor	>0.9
Beam Angle	120
Warranty	2 year*

Colours

Aluminium



Codes

Cordia PE120-AL

Cordia WB52-AL

Cordia WB90-AL

Measurements

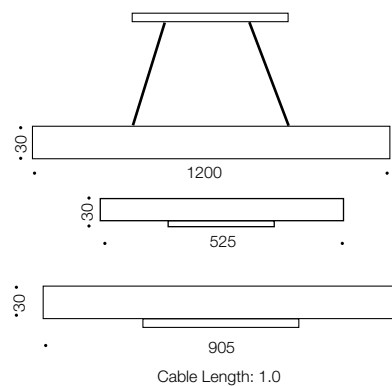

Product Approvals

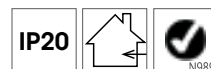



Brit

Pendant



Specifications

Type	Cord Set
Light Source	E27 25w max wShade ring
Globe	Not included
Warranty	1 year*

Colours

Antique brass/black Copper/black

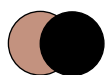

Nickel/black



Nickel/clear

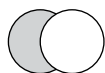

Measurements

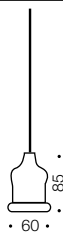

Cable Length: 2.4

Codes

Brit CS-AB/BK

Brit CS-CP/BK

Brit CS-NK/BK

Brit CS-NK/CL

Product Approvals



Enya

Pendant



Specifications

Type	Cord Set
Light Source	E27 25w max wShade ring
Globe	Not included
Warranty	1 year*

Colours

Walnut/clear



Oak/clear



Measurements

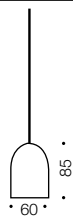

Cable Length: 2.4

Codes

Enya CS-OAK

Enya CS-WL

Product Approvals

IP20



Lang Pendant



Specifications

Type	Cord Set
Light Source	E27 25w max wShade ring
Globe	Not included
Warranty	1 year*

Colours

Antique brass/black Black/black

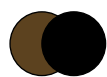

Nickel/black



Nickel/clear

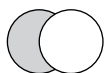

Measurements

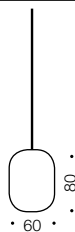

Cable Length: 2.4

Codes

Lang CS-AB/BK

Lang CS-BK/BK

Lang CS-NK/BK

Lang CS-NK/CL

Product Approvals



Bee, Sole & Vess

Pendant & Batten Fix



Specifications

Type	Pendant
Light Source	40w max
Globe	Not included
Warranty	1 year*

Colours

Copper/clear/chrome

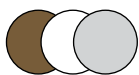

Chrome/clear/chrome



Measurements

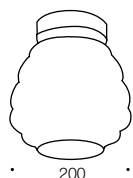

Cable Length: 2.4

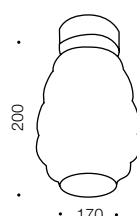

Cable Length: 2.4

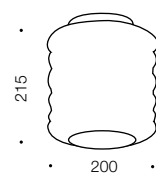

Cable Length: 2.4

Codes

VessPE-CH	Sole PE-CH
VessPE-CP	Sole PE-CP
Vess BF-CH	Sole BF-CH
Vess BF-CP	Sole BF-CP
Bee BF-CH	Bee PE-CH
Bee BF-CP	Bee PE-CP

Product Approvals

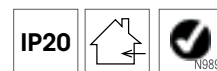

Tolosa

Pendant



Specifications

Type	Pendant
Light Source	Cob GU10
Lumen	500
Colour Temp	3000K
Wattage	6w
Dimmable	No
CRI	>80
Power Factor	>0.9
Beam Angle	140
Warranty	2 year*

Colours

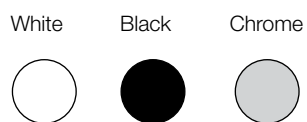

Codes

Tolosa PE1-BK

Tolosa PE1-WH

Tolosa PE1-CH

Measurements

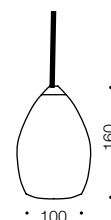

Cable length: 1.5

Product Approvals



Tigra

Pendant



Specifications

Type	Pendants
Light Source	LED
Lumen	3360/3900
Colour Temp	4000k
Wattage	6x7w / 7x7w
Dimmable	Yes
CRI	79
Power Factor	>0.9
Beam Angle	120
Warranty	2 year*

Colours

White



Codes

Tigra PE54-WH

Tigra PE80-WH

Measurements

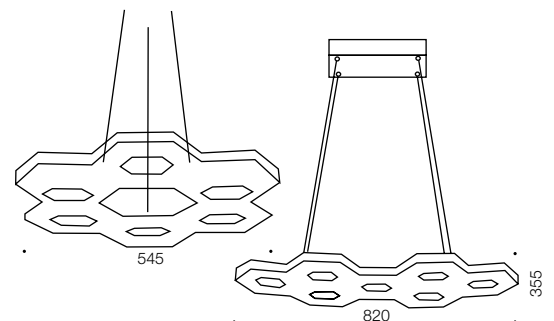

Cable Length: 2.1

Product Approvals



Keller

Pendant



Specifications

Type	Pendant
Light Source	E27 60w max
Globe	Not included
Warranty	1 year*

Measurements

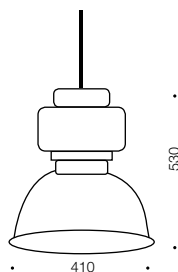

Colours

White



Codes

Keller PE-WH

Product Approvals



Balon

Pendant



Specifications

Type	Pendant
Light Source	E27 40w max
Globe	Not included
Warranty	1 year*

Colours

Aluminium



Measurements

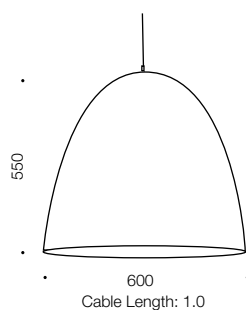

Codes

Balon PE60-AL

Product Approvals

IP20



Tetris

Pendant & CTC



Specifications

Type	Pendant & CTC
Light Source	LED
Lumen	3200
Colour Temp	4000k
Wattage	8 x 5w
Dimmable	Yes
CRI	>80
Power Factor	>0.9
Beam Angle	120
Warranty	2 year*

Colours

Chrome



Codes

Tetris PE8-CH

Tetris CTC4-CH

Tetris CTC6-CH

Measurements

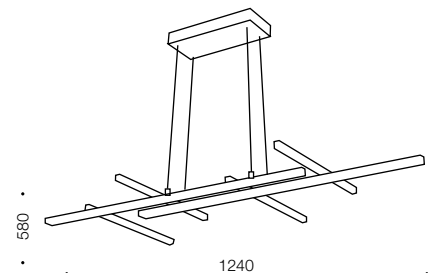

Cable Length: 2.1

Product Approvals





Cosmic

Pendant



Specifications

Type	Pendant
Light Source	G9 Halogen 28w
Globe	Included
Warranty	1 year*

Colours

Chrome/smoke

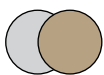

Measurements

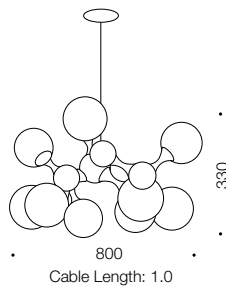

Codes

Cosmic PE80-CH

Product Approvals



Bortoli

Pendant & Oyster



Specifications

Type	Pendant
Light Source	LED
Lumen	2000/2800
Colour Temp	4000k
Wattage	32w/16w+32w
Dimmable	Yes
CRI	>80
Power Factor	>0.9
Beam Angle	120
Warranty	2 year*

Colours

Chrome/crystal



Measurements

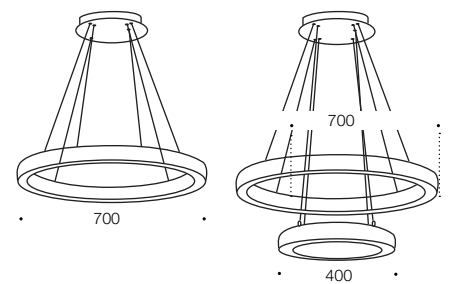

Cable Length: 2.1

Codes

Bortoli P70-CH

Bortoli P7040-CH

Product Approvals





Specifications

Type	Pendant
Light Source	LED
Lumen	1500/2300
Colour Temp	4000k
Wattage	12w+24w/22w
Dimmable	Yes
CRI	>80
Power Factor	>0.9
Beam Angle	120
Warranty	2 year*

Colours

Chrome/crystal



Measurements

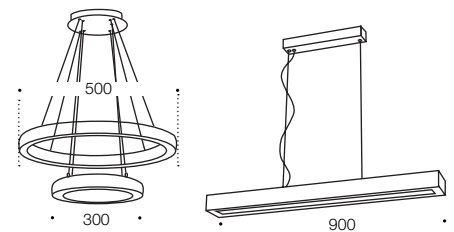

Cable Length: 2.1

Codes

Bortoli P5030-CH

Bortoli P90-CH

Bortoli OY45-CH

Product Approvals



Vertigo & Chantel

Pendant

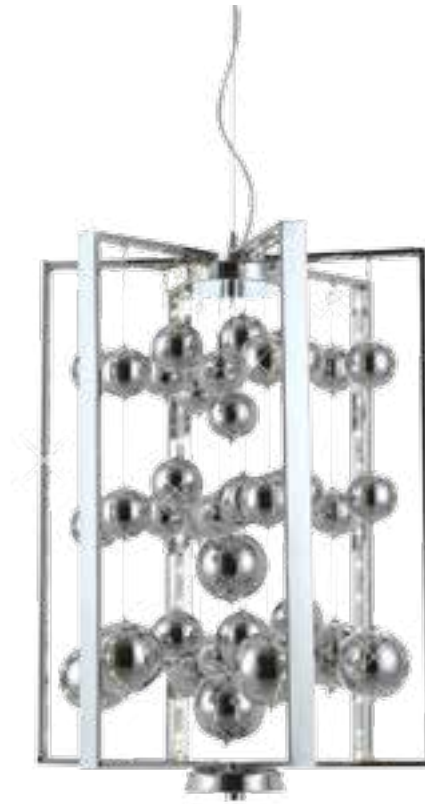

Specifications

Type	Pendant
Light Source	LED
Lumen	1950
Colour Temp	4000k
Wattage	29w/27w SMD
Dimmable	Yes
CRI	>80
Power Factor	>0.9
Beam Angle	120
Warranty	2 year*

Colours

Chrome



Measurements

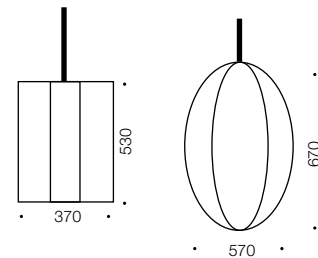

Cable Length: 1.0

Codes

Chantel PE57-CH

Vertigo PE57-CH

Product Approvals



Cascade

Pendant



Specifications

Type	Pendant
Light Source	E14 60w max
Globe	Not included
Warranty	1 year*

Colours

Chrome/gold with crystal



Measurements

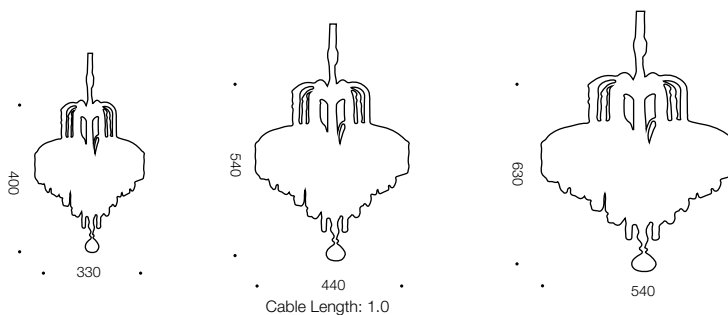

Codes

Cascade PE33-CH

Cascade PE33-GD

Cascade PE43-CH

Cascade PE43-GD

Cascade PE53-CH

Cascade PE53-GD

Product Approvals





Aragon

Pendant



Specifications

Type	Pendant
Light Source	E27
Globe	Not included
Warranty	1 year*

Measurements

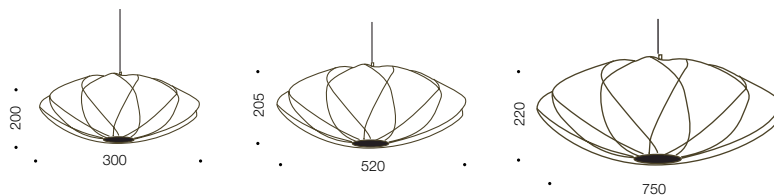

Cable Length: 1.0

Colours

Nickel with white shade
Made in poly resin material



Codes

Aragon PE35-WH

Aragon PE52-WH

Aragon PE75-WH

Product Approvals



Coote

Pendant



Specifications

Type	Pendant
Light Source	E27 60w
Globe	Not included
Warranty	1 year*

Colours

Nicke/white shade
Made in poly resin material



Measurements

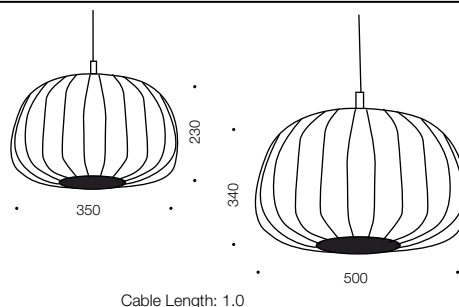

Codes

Coote PE35-WH

Coote PE50-WH

Product Approvals



Seattle

Pendant



Specifications

Type	Pendant
Light Source	E14 28w max
Globe	Included
Warranty	1 year*

Colours

Chrome with crystal white/black shade



Measurements

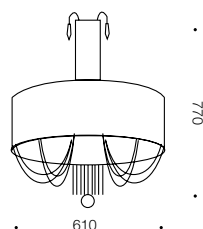

Cable Length: 1.0

Codes

Seattle PE6-CHBK

Seattle PE6-CHWH

Product Approvals



Mason

Pendant



Specifications

Type	Pendant
Light Source	E27 60w max
Globe	Not included
Warranty	1 year*

Measurements

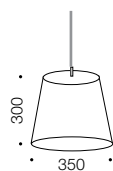

Cable Length: 1.0

Colours

Mica Shade/chrome

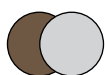

Codes

Mason PE35-CF

Product Approvals



Yomo

Pendant



Specifications

Type	Pendant
Light Source	E27 60w max
Globe	Not included
Warranty	1 year*

Colours

Nickel/rattan



Measurements

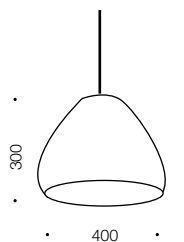

Cable Length: 1.0

Codes

Yomo PE31-NK/BRN

Product Approvals





Rachel

Pendant & Batten fix



Specifications

Type	Pendant & Batten fix
Light Source	E27 40w max
Globe	Not included
Warranty	1 year*

Colours

Black/white



Red/white



Coffee/white
(only batten fix)



White/white/
chrome



Codes

Rachel PE40-BK	Rachel PE60-RD
Rachel PE40-WH	Rachel PE90-BK
Rachel PE40-RD	Rachel PE90-WH
Rachel PE60-BK	Rachel PE90-RD
Rachel PE60-WH	
Rachel BF-BK	
Rachel BF-CF	
Rachel BF-RD	
Rachel BF-WH	

Measurements

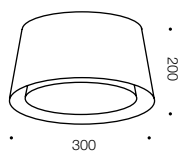
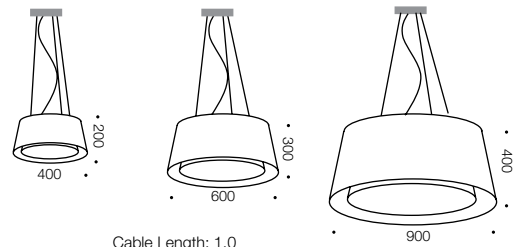

Product Approvals



Bresno

Pendant



Specifications

Type	Pendant
Light Source	E27 25w max
Globe	Not included
Warranty	1 year*

Colours

Black/oak



Red/oak



White/oak



Measurements

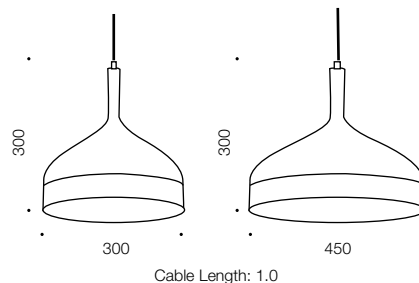

Codes

Bresno
PE30-BK

Bresno
PE45-BK

Bresno
PE30-RD

Bresno
PE45-RD

Bresno
PE30-WH

Bresno
PE45-WH

Product Approvals



Chloe

Pendant



Specifications

Type	Pendant
Light Source	E27 60w max
Globe	Not included
Warranty	1 year*

Colours

Chrome/black



Chrome/silver



Chrome/red

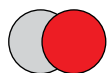

Measurements

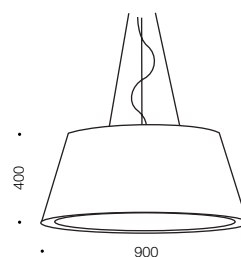
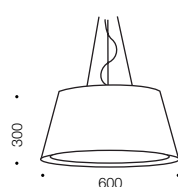
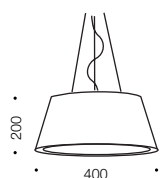

Cable Length: 1.0

Codes

Chloe PE40-BK

Chloe PE90-BK

Chloe PE40-SL

Chloe PE90-SL

Chloe PE40-RD

Chloe PE90-RD

Chloe PE60-BK

Chloe PE60-SL

Product Approvals



Delphi

Pendant



Specifications

Type	Pendant
Light Source	E27 60w max
Globe	Not included
Warranty	1 year*

Colours

Chrome/black



Chrome/red



Chrome/opal



Measurements

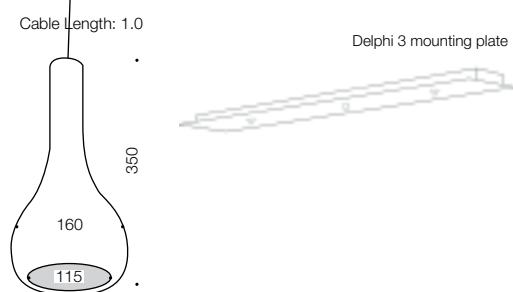

Codes

Delphi PE1-WH

Delphi PE1-RD

Delphi PE1-BK

Product Approvals



Lecona

Pendant



Specifications

Type	Pendant
Light Source	E27 60w max
Globe	Not included
Warranty	1 year*

Measurements

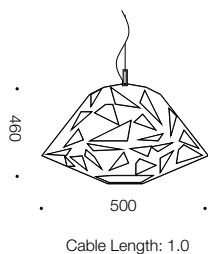

Colours

White/black



Codes

Lecona PE50-BK

Lecona PE50-WH

Product Approvals





Tito

Pendant



Specifications

Type	Pendant
Light Source	E27 40w max
Globe	Not included
Warranty	1 year*

Colours

Chrome/black

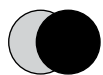

Chrome/red

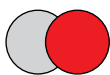

Chrome/white



Measurements

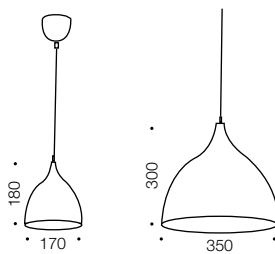

Cable Length: 1.0

Codes

Tito PE17-BK

Tito PE35-BK

Tito PE17-RD

Tito PE35-RD

Tito PE17-WH

Tito PE35-WH

Product Approvals

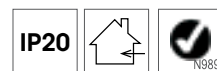

Giro

Pendant



Specifications

Type	Pendant
Light Source	E27 40w max
Globe	Not included
Warranty	1 year*

Colours

Nickel/black

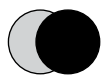

Nickel/red

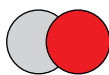

Nickel/opal

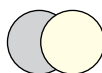

Measurements

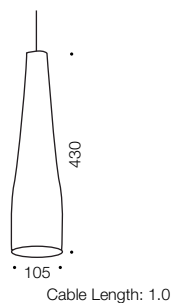

Codes

Giro PE-BK

Giro PE-OP

Giro PE-RD

Product Approvals

IP20



Mondo

Pendant



Specifications

Type	Pendant
Light Source	E14 40w max
Globe	Not included
Warranty	1 year*

Measurements

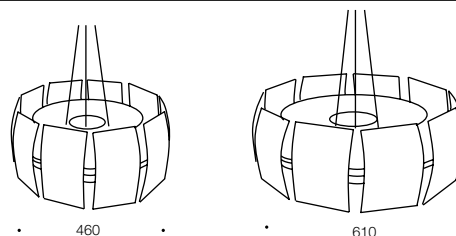

Cable Length: 1.0

Colours

Red/chrome



Codes

Mondo PE46-RD

Mondo PE61-RD

Product Approvals



Noni

Pendant



Specifications

Type	Pendant
Light Source	6w PAR GU10 4000K
Globe	Included
Warranty	2 year*

Colours

Chrome/clear

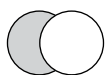

Measurements

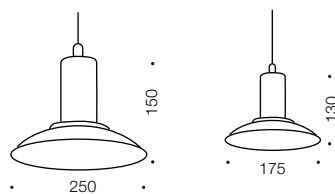

Cable Length: 1.0

Codes

Noni PE17-CH

Noni PE25-CH

Product Approvals



Bally

Pendant



Specifications

Type	Pendant
Light Source	E27 40w max
Globe	Not included
Warranty	1 year*

Colours

Nickel metal wire/opal matt



Measurements

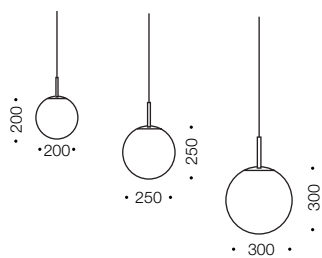

Codes

Bally PE 8

Bally PE 10

Bally PE 12

Product Approvals



Kay

Pendant



Specifications

Type	Pendant
Light Source	E27 60w max
Globe	Not included
Warranty	1 year*

Colours

Aluminium



Measurements

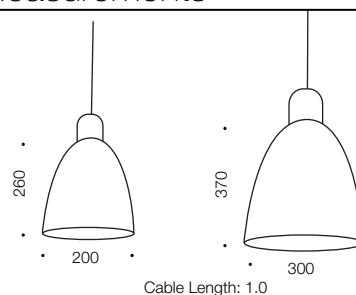

Codes

Kay PE20-AL

Kay PE30-AL

Product Approvals



Arcadia

Pendant



Specifications

Type	Pendant
Light Source	E27 40w max 240v
Globe	Not included
Warranty	1 year*

Colours

Chrome



Measurements

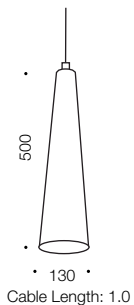

Codes

Arcadia PE 50-CH

Product Approvals





Tribe

Pendant, Floor & Table Lamp



Specifications

Type	Pendant
Light Source	E27 40w max
Globe	Not included
Warranty	1 year*

Colours

Brown/white

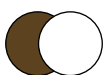

Measurements

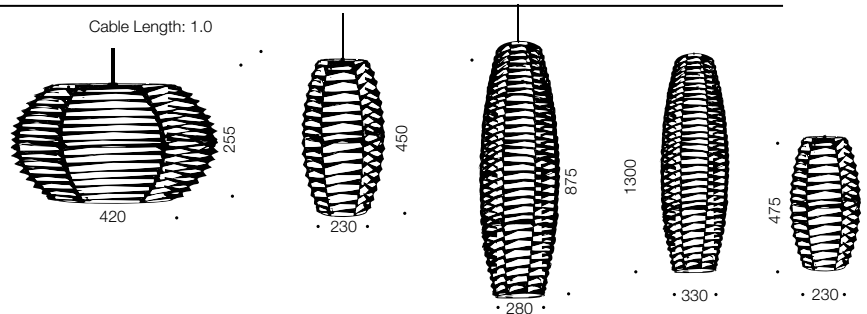

Codes

Tribe PE23-BN Tribe PE23-WH

Tribe PE28-BN Tribe PE28-WH

Tribe PE42-BN Tribe PE42-WH

Tribe FL-BN Tribe FL-WH

Tribe TL-BN Tribe TL-WH

Product Approvals



Tarakan

Pendant



Specifications

Type	Pendant
Light Source	E27 40w max
Globe	Not included
Warranty	1 year*

Measurements

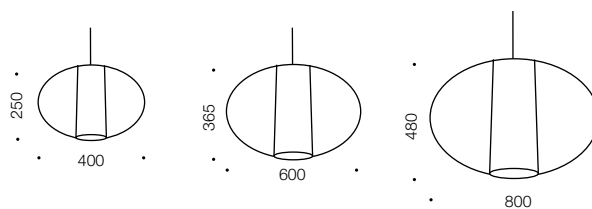

Cable Length: 1.0

Colours

Black/white shade



Codes

Tarakan PE40-BK

Tarakan PE60-BK

Tarakan PE80-BK

Product Approvals



Maluka

Pendant & Floor Lamps



Specifications

Type	Pendant
Light Source	E14 40w max
Globe	Not included
Warranty	1 year*

Measurements

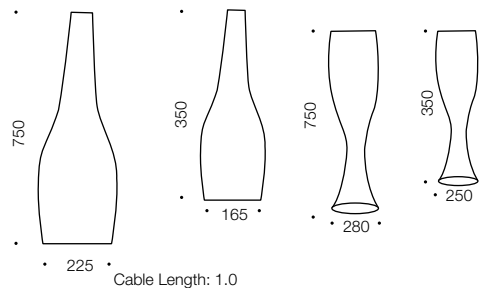

Colours

Rattan frame/white fabric shade

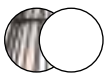

Codes

Maluka PE_L-RTN

Maluka PE_S-RTN

Maluka FL_S-RTN

Maluka PE_L-RTN

Product Approvals



Misha

Pendant



Specifications

Type	Pendant
Light Source	E27 60w max
Globe	Not included
Warranty	1 year*

Colours

White lycra fabric with nickel



Measurements

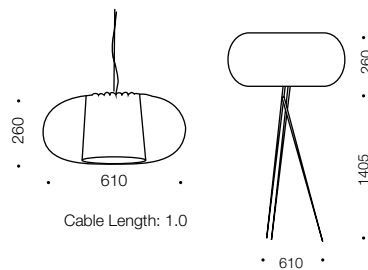

Codes

Misha PE61-WH

Misha FL-NK/WH

Product Approvals

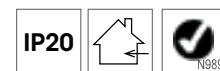

Ketu

Pendant



Specifications

Type	Pendant
Light Source	LED
Lumen	650/1300
Colour Temp	4000k
Wattage	8x1w 2x8x1w
Dimmable	No
CRI	>80
Power Factor	>0.9
Beam Angle	140
Warranty	2 year*

Colours

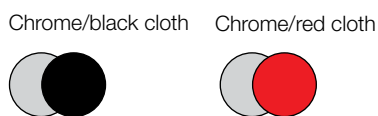

Measurements

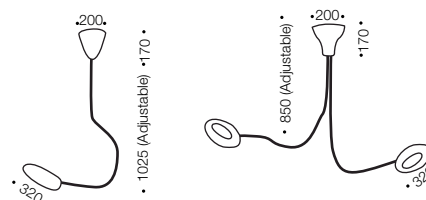

Codes

Ketu PE1-BK

Ketu PE1-RD

Ketu PE2-BK

Ketu PE2-RD

Product Approvals





Artis

Pendant



Specifications

Type	Pendant
Light Source	E27 40w max
Globe	Not included
Warranty	1 year*

Measurements

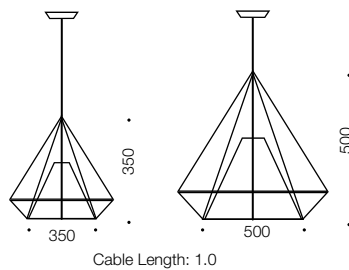

Colours

Black/white



Codes

Artis PE35-BK/WH

Artis PE50-BK/WH

Product Approvals



Mina

Pendant



Specifications

Type	Pendant
Light Source	E27 40w Pilot
Globe	Included
Warranty	1 year*

Colours

Oil bronze/clear

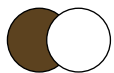

Measurements

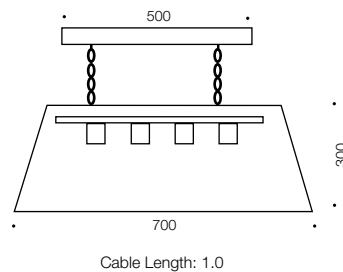

Codes

Mina PE4-OB/CL

Product Approvals



Ibiza

Pendant



Specifications

Type	Pendant
Light Source	E27 40w Pilot
Globe	Included
Warranty	1 year*

Colours

Oil bronze/clear

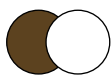

Measurements

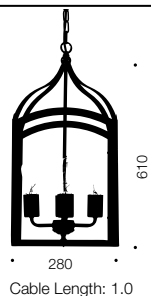

Codes

Ibiza PE4-OB/CL

Product Approvals



Largo

Pendant



Specifications

Type	Pendant
Light Source	E27 Pilot 25w max
Globe	Included
Warranty	1 year*

Colours

Oil bronze/clear



Measurements

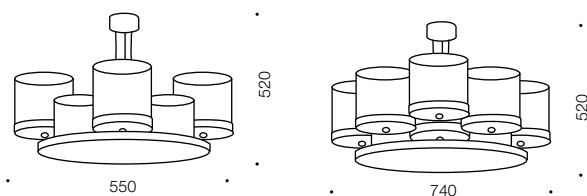

Cable Length: 1.0

Codes

Largo PE5-OB/CL

Largo PE8-OB/CL

Product Approvals



Fitch

Pendant



Specifications

Type	Pendant
Light Source	E27 60w max
Globe	Not included
Warranty	1 year*

Colours

Nickel/opal matt

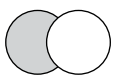

Measurements

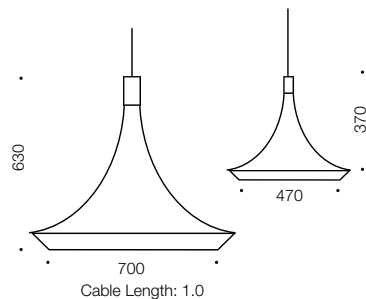

Codes

Fitch PE47-OM

Fitch PE70-OM

Product Approvals





Alden & Norvel

Pendant



Specifications

Type	Pendant
Light Source	E27 25w Pilot Vintage filament
Globe	Included
Warranty	1 year*

Colours

Chanpagne/nickel-silver-oak



Clear/nickel-black-nickel



Measurements

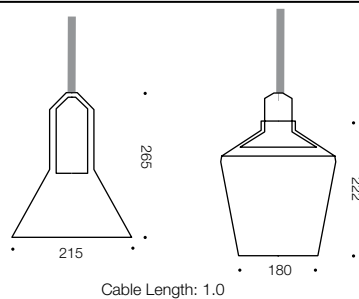

Codes

Alden PE-CHM

Alden PE-CLR

Doyle PE-CHM

Doyle PE-CLR

Product Approvals

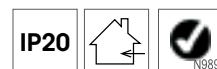

Catino

Pendant



Specifications

Type	Pendant
Light Source	E27 60w max
Globe	Not included
Warranty	1 year*

Colours

Nickel



Measurements

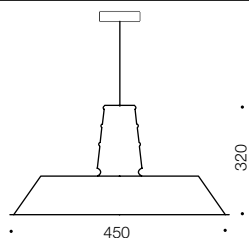

Cable Length: 1.0

Codes

Catino PE45-NK

Product Approvals



Moody

Pendant



Specifications

Type	Pendant
Light Source	E27 60w max
Globe	Not included
Warranty	1 year*

Measurements

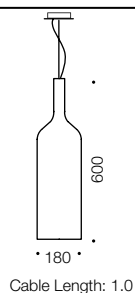

Colours

Champaigne/
nickel matt

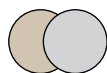

Opal/nickel matt

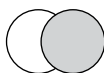

Smoke/nickel matt

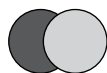

Codes

Moody PE-CHM

Moody PE-OP

Moody PE-SM

Product Approvals



Zucchi

Pendant



Specifications

Type	Pendant
Light Source	E27 60w
Globe	Not included
Warranty	1 year*

Colours

Nickel & opal matt glass

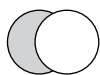

Measurements

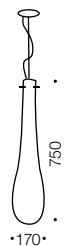

Cable Length: 1.0

Codes

Zucchi PE 075-OM

Product Approvals



Atone

Pendant



Specifications

Type	Pendant
Light Source	G9 28w max
Globe	Included
Warranty	1 year*

Colours

Chrome/frost

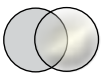

Measurements

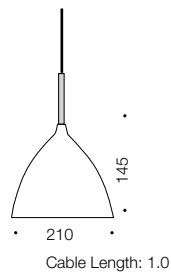

Codes

Atone PE-Frost

Product Approvals



Tonty

Pendant



Specifications

Type	Pendant
Light Source	E27 60w max
Globe	Not included
Warranty	1 year*

Colours

Nickel/opal matt

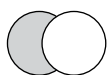

Measurements

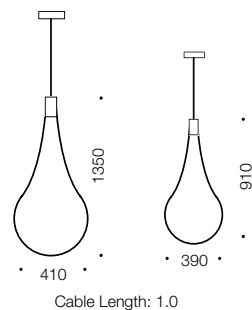

Codes

Tonty PE35-OM

Tonty PE41-OM

Product Approvals



Bolle

Pendant



Specifications

Type	Pendant
Light Source	E14 60w max
Globe	Not included
Warranty	1 year*

Measurements

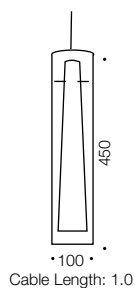

Colours

Chrome/orange



Chrome/
opal matt

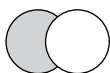

Chrome/green glass

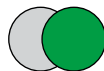

Codes

Bolle PE-CH/GN

Bolle PE-CH/OP

Bolle PE-CH/OM

Product Approvals





Dream

Pendant & CTC



Specifications

Type	Pendant & CTC
Light Source	LED
Lumen	2350
Colour Temp	4000k
Wattage	18w/ 30w SMD
Dimmable	Yes
CRI	>80
Power Factor	>0.9
Beam Angle	120
Warranty	2 year*

Colours

Clear/chrome

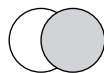

Codes

Dream PE30-CH

Dream CTC18-CH

Measurements

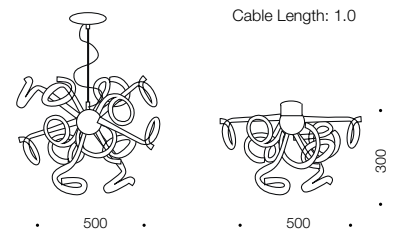

Product Approvals



Eva

Pendant



Specifications

Type	Pendant
Light Source	E27 60w max
Globe	Not included
Warranty	1 year*

Colours

Aluminium



Measurements

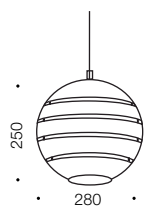

Cable Length: 1.0

Codes

Eva PE28-AL

Product Approvals



Lea

Pendant



Specifications

Type	Pendant
Light Source	E27 60w max
Globe	Not included
Warranty	1 year*

Colours

Aluminium



Measurements

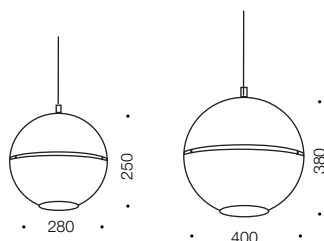

Cable Length: 1.0

Codes

Lea PE28-AL

Lea PE40-AL

Product Approvals



Chelsea

Pendant & Wall Lamp



Specifications

Type	Pendant
Light Source	2w/3w/6w 33w G9 osram
Globe	Included
Warranty	1 year*

Colours

Chrome/crystal

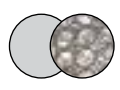

Measurements

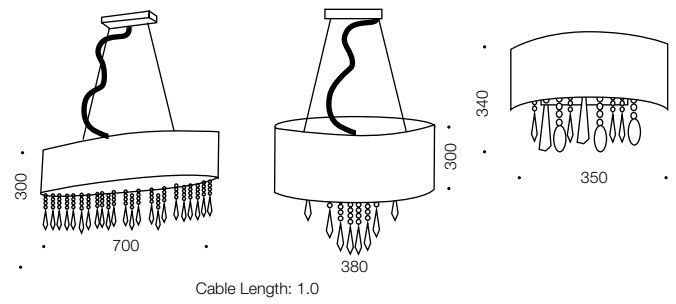

Codes

- Chelsea PE5-CH

- Chelsea PE6-CH

- Chelsea WB3-CH

Product Approvals



Haig Pendant



Specifications

Type	Pendant
Light Source	E14 28w max
Globe	Not included
Warranty	1 year*

Colours

Nickel/clear

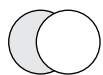

Nickel/opal

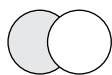

Nickel/red



Measurements

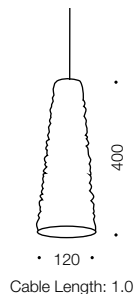

Codes

Haig PE160-CL

Haig PE160-OP

Haig PE160-RD

Product Approvals

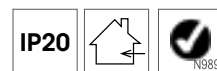

Diva

Pendant



Specifications

Type	Pendant
Light Source	E27 60w max
Globe	Not included
Warranty	1 year*

Colours

Nickel/opal matt

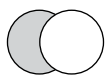

Measurements

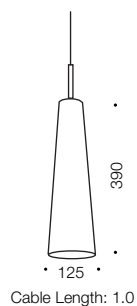

Codes

Diva PE-NK/OM

Product Approvals



Botega

Pendant



Specifications

Type	Pendant
Light Source	E27 60w max
Globe	Not included
Warranty	1 year*

Measurements

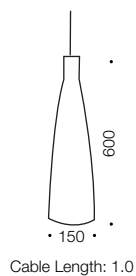

Colours

Nickel/opal matt

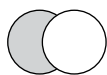

Codes

Botega 1 PE NK

Product Approvals

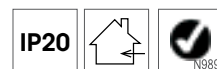

Bisset

Pendant



Specifications

Type	Pendant
Light Source	E27 40w max
Globe	Not included
Warranty	1 year*

Colours

Nickel/opal matt

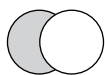

Measurements

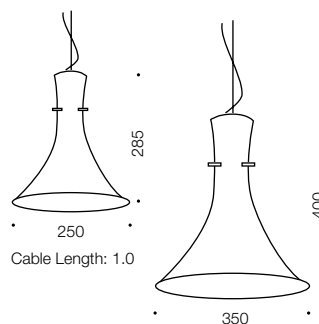

Codes

Bisset PE 25-OM

Bisset PE 35-OM

Product Approvals



Kamoto

Pendant



Specifications

Type	Pendant
Light Source	LED
Lumen	395
Colour Temp	3000k
Wattage	5w
Dimmable	No
CRI	>80
Power Factor	>0.9
Beam Angle	120
Warranty	2 year*

Colours

Chrome/frost

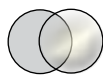

Measurements

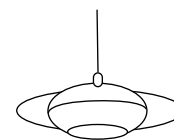

220
Cable Length: 1.0

Codes

Kamoto PE1-CH

Product Approvals



Futura

Pendant



Specifications

Type	Pendant
Light Source	LED
Lumen	1400
Colour Temp	3000k
Wattage	20w
Dimmable	No
CRI	>80
Power Factor	>0.9
Beam Angle	120
Warranty	2 year*

Colours

Chrome/opal



Measurements

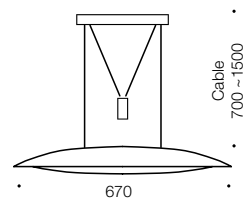

Codes

Futura PE67-NK

Product Approvals



Miki

Pendant



Specifications

Type	Pendant
Light Source	LED
Lumen	2900
Colour Temp	4000k
Wattage	36w
Dimmable	Yes
CRI	>80
Power Factor	>0.9
Beam Angle	120
Warranty	2 year*

Colours

Aluminium/frost

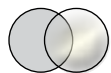

Measurements

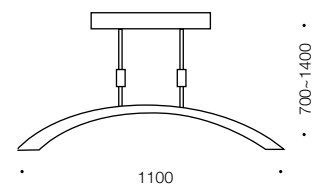

Codes

Miki PE36-AL/FR

Product Approvals



Keras

Pendant



Specifications

Type	Pendant
Light Source	E27 60w max
Globe	Not included
Warranty	1 year*

Measurements

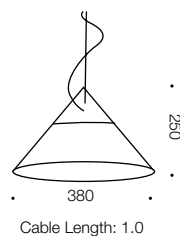

Colours

Black opaline glass



Red opaline glass



Codes

Keras PE38-BK

Keras PE38-RD

Product Approvals

IP20



Close to ceiling





Tetris

CTC & Pendant



Specifications

Type	CTC
Light Source	LED
Lumen	1600 / 2400
Colour Temp	4000k
Wattage	4 x 5w / 6 x 5w
Dimmable	Yes
CRI	>80
Power Factor	>0.9
Beam Angle	120
Warranty	2 year*

Colours

Chrome



Codes

Tetris PE8-CH

Tetris CTC4-CH

Tetris CTC6-CH

Measurements

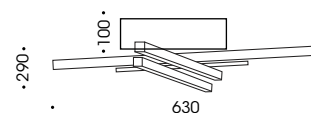
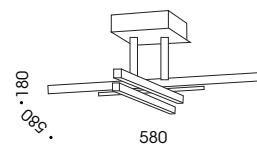

Product Approvals

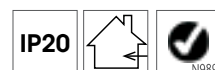

Seville

Close to ceiling



Specifications

Type	CTC
Light Source	28w G9
Globe	Included
Warranty	1 year*

Measurements

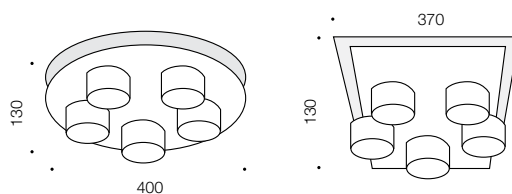

Colours

Chrome/clear

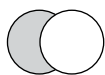

Codes

Seville CTC5R-CH

Seville CTC5S-CH

Product Approvals

IP20



Camillia

Close to ceiling



Specifications

Type	CTC
Light Source	E14 240v 60w
Globe	Not included
Warranty	1 year*

Measurements



Colours

Chrome/gold with clear glass

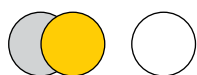

Codes

Camillia 3+1 GD

Camillia 5+1 CH

Camillia 5+1 GD

Product Approvals



Edith

Close to ceiling



Specifications

Type	CTC
Light Source	33w G9 OSRAM
Globe	Included
Warranty	1 year*

Colours

Chrome/crystal



Measurements

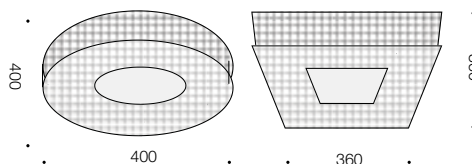

Codes

Edith RD-CH

Edith 5SQ-CH

Product Approvals

IP20



Ramon

Close to ceiling



Specifications

Type	CTC
Light Source	LED
Lumen	1350
Colour Temp	3000k
Wattage	9 x 2.5w
Dimmable	No
CRI	>80
Power Factor	>0.9
Beam Angle	120
Warranty	2 year*

Colours

Chrome/crystal



Measurements

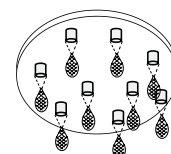

440

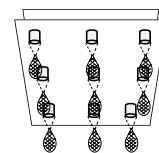

370

Codes

Ramon RD9-CH

Ramon SQ9-CH

Product Approvals





Epoca

Close to ceiling



Specifications

Type	CTC
Light Source	LED
Lumen	1700
Colour Temp	5000k
Wattage	6 x 3.5w
Dimmable	Yes
CRI	>80
Power Factor	>0.9
Beam Angle	120
Warranty	2 year*

Colours

Chrome/gold

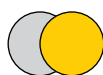

Measurements

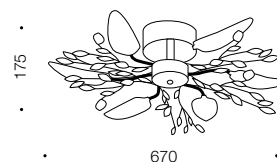

Codes

Epoca CTC60-CH

Epoca CTC60-GD

Product Approvals

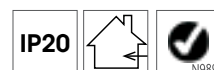

Sally

Close to ceiling



Specifications

Type	CTC
Light Source	28w G9
Globe	Included
Warranty	1 year*

Colours

Chrome/clear

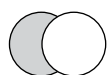

Measurements

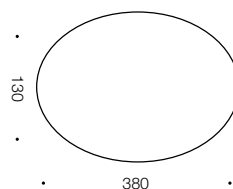

Codes

Sally CTC6-CH

Product Approvals

IP20



Penrith

Close to ceiling



Specifications

Type	CTC
Light Source	28w G9 max
Globe	Included
Warranty	1 year*

Measurements



Colours

Chrome/clear

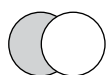

Codes

Penrith CTC9-CH

Product Approvals



Denby

Close to ceiling



Specifications

Type	CTC
Light Source	LED
Lumen	740
Colour Temp	4000K
Wattage	12w
Dimmable	No
CRI	>80
Power Factor	>0.9
Beam Angle	120
Warranty	2 year*

Colours

Chrome/opaline

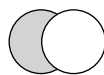

Measurements

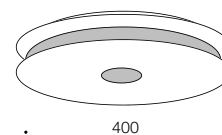

Codes

Denby PE5-CH

Denby CTC12-CH

Product Approvals

IP20



Batten Fix



App

Batten Fix



Specifications

Type	Batten Fix
Light Source	40w max
Globe	Not included
Warranty	1 year*

Colours

Nickel/frost

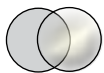

Measurements

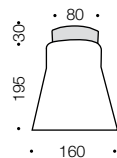

Codes

App BF-FR

Product Approvals



Luk

Batten Fix



Specifications

Type	Batten Fix
Light Source	40w max
Globe	Not included
Warranty	1 year*

Colours

Nickel/frost

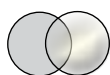

Measurements

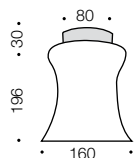

Codes

Luk BF-FR

Product Approvals

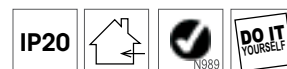

Oma

Batten Fix



Specifications

Type	Batten Fix
Light Source	40w max
Globe	Not included
Warranty	1 year*

Colours

Nickel/frost

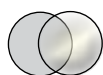

Measurements

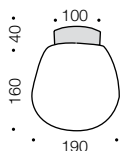

Codes

Oma BF-FR

Product Approvals



Bee

Batten Fix



Specifications

Type	Batten Fix
Light Source	40w max
Globe	Not included
Warranty	1 year*

Measurements

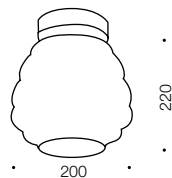

Colours

Copper/clear/chrome

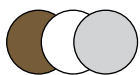

Chrome/clear/chrome



Codes

Bee BF-CH

Bee BF-CP

Product Approvals

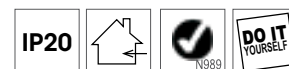

Sole

Batten Fix



Specifications

Type	Batten Fix
Light Source	40w max
Globe	Not included
Warranty	1 year*

Measurements

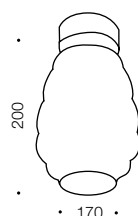

Colours

Copper/clear/chrome



Chrome/clear/chrome



Codes

Sole BF-CH

Sole BF-CP

Product Approvals

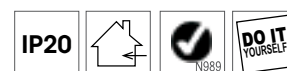

Vess

Batten Fix



Specifications

Type	Batten Fix
Light Source	40w max
Globe	Not included
Warranty	1 year*

Measurements

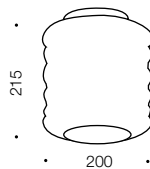

Colours

Copper/clear/chrome

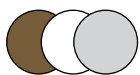

Chrome/clear/chrome



Codes

Vess BF-CH

Vess BF-CP

Product Approvals

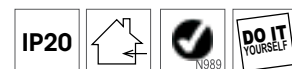



Teca

Batten Fix



Specifications

Type	Batten Fix
Light Source	40w max
Globe	Not included
Warranty	1 year*

Measurements

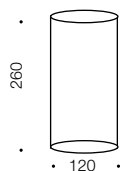

Colours

Amber/nickel



Clear/nickel



Codes

Teca BF-AM

Teca BF-CL

Product Approvals

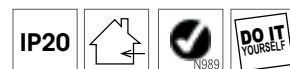

Dutch

Batten Fix



Specifications

Type	Batten Fix
Light Source	40w max
Globe	Not included
Warranty	1 year*

Measurements

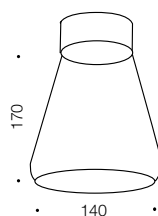

Colours

Amber/nickel



Clear/nickel



Codes

Dutch BF-AM

Dutch BF-CL

Product Approvals



Aries

Batten Fix



Specifications

Type	Batten Fix
Light Source	60w max
Globe	Not included
Warranty	1 year*

Colours

Chrome/chrome & clear

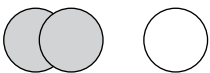

Measurements

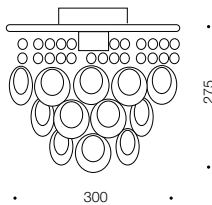

Codes

Aries BF40-CH

Product Approvals

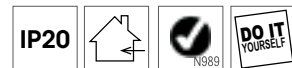

Grace

Batten Fix



Specifications

Type	Batten Fix
Light Source	60w max
Globe	Not included
Warranty	1 year*

Colours

Chrome/clear

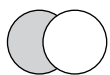

Measurements

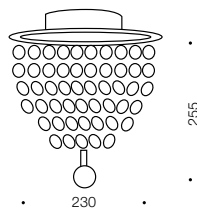

Codes

Grace BF23-CH

Product Approvals



Rachel

Batten Fix



Specifications

Type	Batten Fix
Light Source	40w max
Globe	Not included
Warranty	1 year*

Measurements

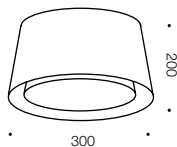

Colours

Black/white



Coffee/white

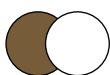

Red/white



White/white/
chrome



Codes

Rachel BF-BK

Rachel BF-CF

Rachel BF-RD

Rachel BF-WH

Product Approvals





Merino

Batten Fix & Pendant



Specifications

Type	Batten Fix
Light Source	60w max
Globe	Not included
Warranty	1 year*

Measurements

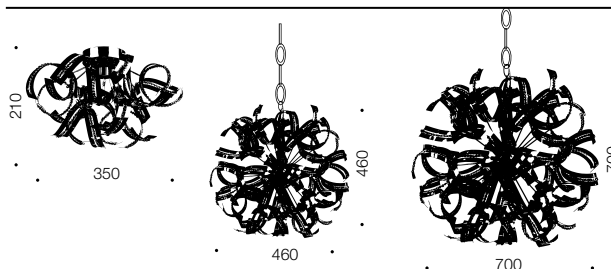

Colours

Chrome/clear



Codes

Merino PE5-CH

Merino PE8-CH

Merino BF-CH

Product Approvals



Olsen

Batten Fix



Specifications

Type	Batten Fix
Light Source	60w max
Globe	Not included
Warranty	1 year*

Measurements

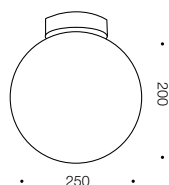

Colours

Chrome/opal matt

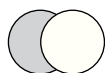

Codes

Olsen BF-CH

Product Approvals

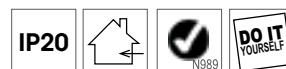

Envoy, Tommy & Lydia

Batten Fix



Specifications

Type	Batten Fix
Light Source	60w max
Globe	Not included
Warranty	1 year*

Colours

Nickel with clear/frost glass



Measurements

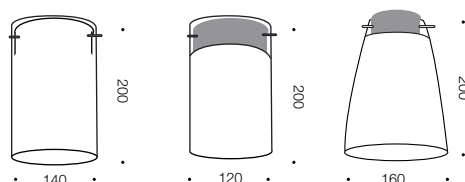

Codes

Envoy BF-OM

Tommy BF-FR

Lydia BF-FR

Product Approvals

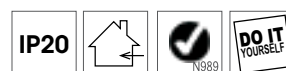

Batten Fix

Batten Fix



Specifications

Type	Batten Fix
Light Source	60w max
Globe	Not included
Warranty	1 year*

Measurements

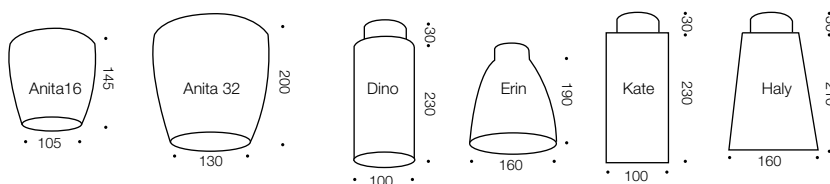

Colours

Nickel/Opal matt

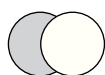

Codes

Anita BF16	Anita BF23
Dino BF	
Erin BF	
Kate BF	
Haly BF	

Product Approvals



Floor/Table Lamp





Edrik

Floor, Table Lamp & Pendant



Specifications

Type	Table / Floor Lamp
Light Source	LED
Lumen	700/1050
Colour Temp	4000k
Wattage	2 x 5w 3 x 5w
Dimmable	No
CRI	>80
Power Factor	>0.9
Beam Angle	120
Warranty	2 year*

Colours

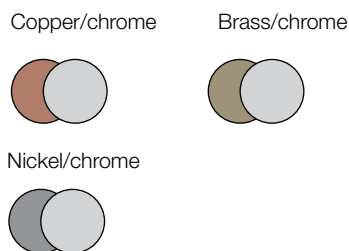

Codes

Edrik PE 4-CP
Edrik PE 4-NK
Edrik PE 4-PB
Edrik FL 3-CP Edrik TL 2-CP
Edrik FL 3-NK Edrik TL 2-NK
Edrik FL 3-PB Edrik TL 2-PB

Measurements

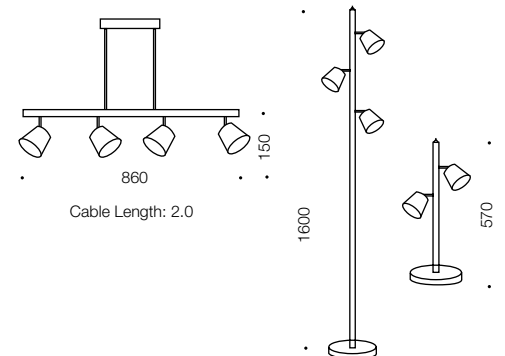

Product Approvals



Hertel

Floor, Table Lamp & Pendant



Specifications

Type	Floor & Table Lamps
Light Source	E27 40w max
Globe	Not included
Warranty	1 year*

Colours

Black/amber



Measurements

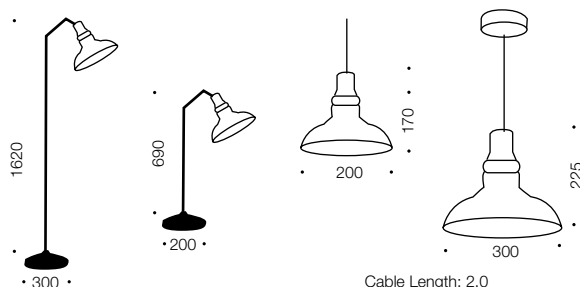

Codes

Hertel PE20-BKAM

Hertel PE30-BKAM

Hertel FL-BK/AM

Hertel TL-BK/AM

Product Approvals



Kuran

Floor, Table Lamp & Pendant



Specifications

Type	Floor & Table Lamps
Light Source	LED
Lumen	320 per unit
Colour Temp	4000k
Wattage	4w per head
Dimmable	No
CRI	>80
Power Factor	>0.9
Beam Angle	120
Warranty	2 year*

Colours

Oak/nickel



Codes

Kuran 4P-OAK

Kuran FL-OAK

Kuran FL.M&S-OAK

Kuran FL2-OAK

Kuran TL-OAK

Measurements

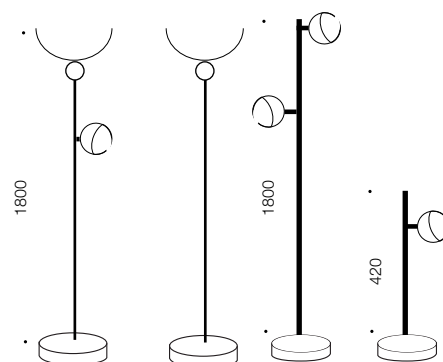

Product Approvals



Oliver

Floor Lamp



Specifications

Type	Floor Lamp
Light Source	LED
Lumen	1600+400
Colour Temp	4000k
Wattage	20w+5w
Dimmable	Yes
CRI	>80
Power Factor	>0.9
Beam Angle	120
Warranty	2 year*

Colours

Nickel/antique brass

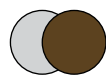

Measurements

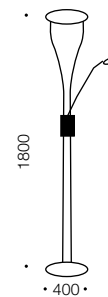

Codes

Oliver FL/M&S-AB

Oliver FL/M&S-NK

Product Approvals



Virgil

Floor Lamp



Specifications

Type	Floor Lamp
Light Source	LED
Lumen	1500/650
Colour Temp	4000k
Wattage	18w/5w
Dimmable	No
CRI	>80
Power Factor	>0.9
Beam Angle	120
Warranty	2 year*

Colours

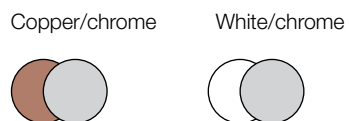

Codes

Virgil FL-CP	Virgil FL M&S-CP
Virgil FL-WH	Virgil FL M&S-WH

Measurements

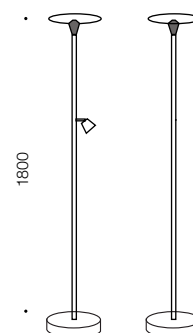

Product Approvals



Dale

Floor & Table Lamp



Specifications

Type	Floor & Table Lamp
Light Source	E27 14w max
Globe	Not included
Warranty	1 year*

Colours

Nickel



Measurements

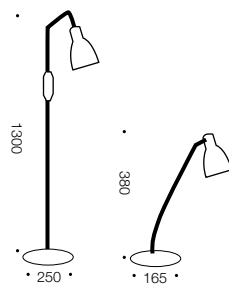

Codes

Dale FL-NK

Dale TL-NK

Product Approvals

IP20



N989

Regus

Floor Lamp



Specifications

Type	Floor Lamp
Light Source	E27 60w max
Globe	Not included
Warranty	1 year*

Colours

White/white



Measurements

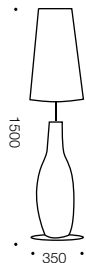

Codes

Regus FL-WH/WH

Product Approvals





Pena

Floor, Table Lamp & Wall Lamp



Specifications

Type	Table / Floor Lamp
Light Source	LED
Lumen	700 / 840
Colour Temp	4000k
Wattage	10w / 15w
Dimmable	No
CRI	>80
Power Factor	>0.9
Beam Angle	120
Warranty	2 year*

Colours

Copper/chrome

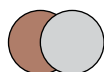

Measurements

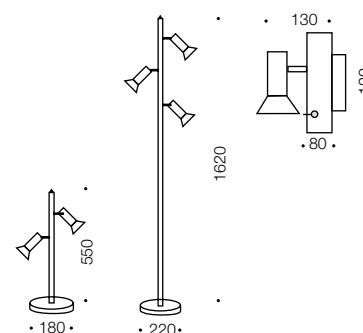

Codes

Pena FL3-CP/CH

Pena TL2-CP/CH

Product Approvals



Belmore

Floor & Table Lamp



Specifications

Type	Floor & Table Lamp
Light Source	E27 60w max
Globe	Not included
Warranty	1 year*

Colours

Walnut/teak with line shade



Measurements

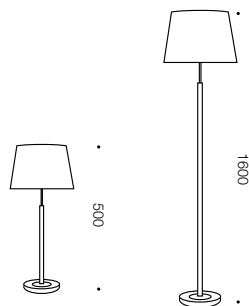

Codes

Belmore FL-TK

Belmore FL-WL

Belmore TL-TK

Belmore TL-WL

Product Approvals



Fonda

Floor & Table Lamp



Specifications

Type	Floor & Table Lamp
Light Source	E27 40w max
Globe	Not included
Warranty	1 year*

Colours

Chrome/white

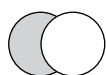

Measurements

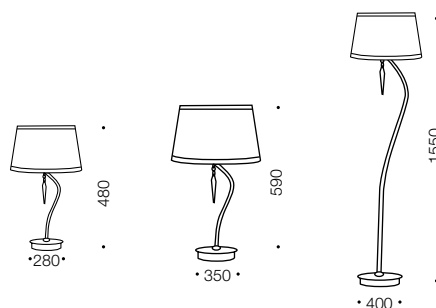

Codes

Fonda FL-CH

Fonda TLL-CH

Fonda TLS-CH

Product Approvals



Watson

Floor & Table Lamp



Specifications

Type	Floor & Table Lamps
Light Source	E27 25w max
Globe	Not included
Warranty	1 year*

Colours

Black/antique brass



Measurements

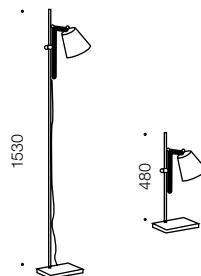

Codes

Watson FL-BKAB

Watson TL-BKAB

Product Approvals

IP20



N989

Serax

Table Lamp



Specifications

Type	Table Lamp
Light Source	LED
Lumen	400
Colour Temp	4000k
Wattage	5w
Dimmable	No
CRI	>80
Power Factor	>0.9
Beam Angle	120
Warranty	2 year*

Colours

Antique brass/copper matt/nickel



Codes

Serax TL-AB

Serax TL-CP

Serax TL-NK

Measurements

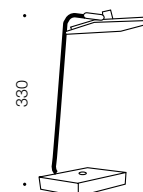

Product Approvals



Misha

Floor Lamp & Pendant



Specifications

Type	Floor Lamp
Light Source	E27 60w max
Globe	Not included
Warranty	1 year*

Colours

Nickel/white

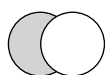

Measurements

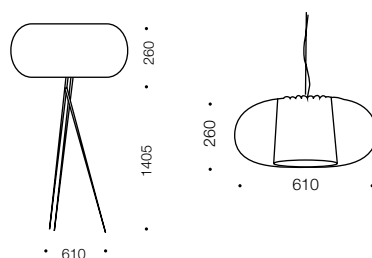

Codes

Misha FL-NK/WH

Misha PE61-WH

Product Approvals

IP20



Argenta

Table Lamp



Specifications

Type	Table Lamp
Light Source	LED
Lumen	320
Colour Temp	4000k
Wattage	4w
Dimmable	No
CRI	>80
Power Factor	>0.9
Beam Angle	120
Warranty	2 year*

Colours

Chrome



Codes

Argenta TL-CH

Measurements

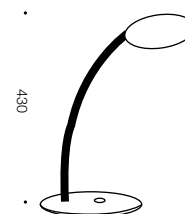

Product Approvals





Korpi

Table Lamp



Specifications

Type	Table Lamp
Light Source	LED
Lumen	350
Colour Temp	4000K
Wattage	5w
Dimmable	No
CRI	>80
Power Factor	>0.9
Beam Angle	120
Warranty	2 year*

Colours

White/antique brass/nickel/black

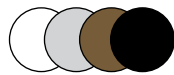

Codes

Korpi TL-AB	Korpi TL-BK
Korpi TL-NK	Korpi TL-WH

Measurements

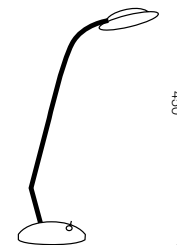

Product Approvals



June

Table Lamp



Specifications

Type	Table Lamp
Light Source	E27 25w max
Globe	Not included
Warranty	1 year*

Measurements

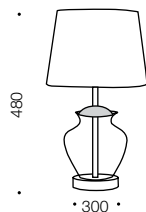

Colours

Chrome/smoke/black Chrome/clear/white

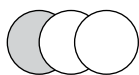
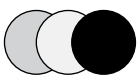

Antique brass/amber/vanilla



Codes

June TL-CHSMBK

June TL-CHCLWH

June TL-ABAMVN

Product Approvals



Moritz

Table Lamp



Specifications

Type	Table Lamp
Light Source	E27 25w max
Globe	Not included
Warranty	1 year*

Measurements

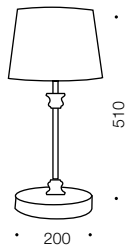

Colours

Copper/white

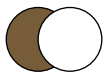

Nickel/white

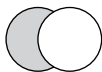

Codes

Moritz TL-CP

Moritz TL-NK

Product Approvals



Spline

Table Lamp



Specifications

Type	Table Lamps
Light Source	E27 40w max
Globe	Not included
Warranty	1 year*

Measurements

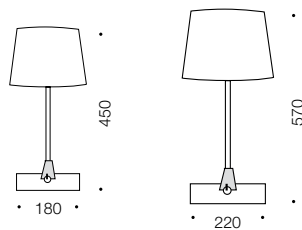

Colours

White/bronze

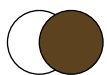

White/copper

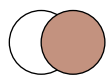

White/nickel



Codes

Spline TLL-BZ Spline TLS-BZ

Spline TLL-CP Spline TLS-CP

Spline TLL-NK Spline TLS-NK

Product Approvals



Merlin

Table Lamp & Pendant



Specifications

Type	Table Lamps & Pendants
Light Source	LED
Lumen	400
Colour Temp	4000k
Wattage	5w
Dimmable	No
CRI	>80
Power Factor	>0.9
Beam Angle	120
Warranty	2 year*

Colours

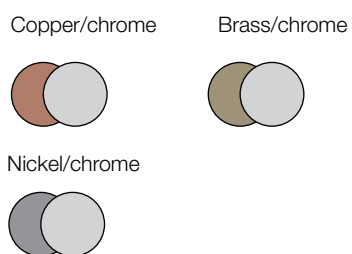

Codes

Merlin PE20-CP	Merlin PE40-CP
Merlin PE20-NK	Merlin PE40-NK
Merlin PE20-PB	Merlin PE40-PB
Merlin TL-CP	Merlin TL-NK
Merlin TL-PB	

Measurements

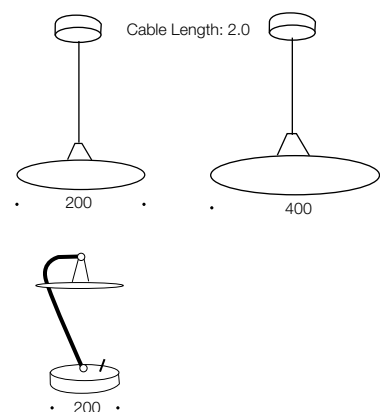

Product Approvals





Arkos

Floor & Table Lamp



Specifications

Type	Table Lamp
Light Source	E27 40w max
Globe	Not included
Warranty	1 year*

Colours

Black marble/black White marble/white



Measurements

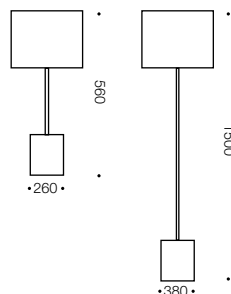

Codes

Arkos FL-BKM/BK

Arkos FL-WHM/WH

Arkos TL-BKM/BK

Arkos TL-WHM/WH

Product Approvals

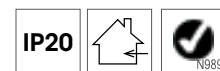

Toledo

Table Lamp



Specifications

Type	Table Lamp
Light Source	E27 40w max
Globe	Not included
Warranty	1 year*

Measurements

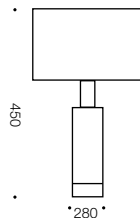

Colours

Chrome/marble/white Copper/marble/black

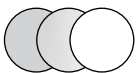

Gold/marble/white

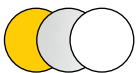

Codes

Toledo TL-CH/WH

Toledo TL-CH/BK

Toledo TL-GD/WH

Product Approvals



Agora

Table Lamp



Specifications

Type	Table Lamp
Light Source	E27 40w max
Globe	Not included
Warranty	1 year*

Measurements

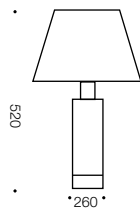

Colours

Chrome/marble/black Gold/marble/black

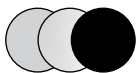

Codes

Agora TL-CH/BK

Agora TL-GD/BK

Product Approvals

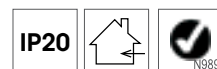

Milo

Table Lamp



Specifications

Type	Table Lamp
Light Source	E27 40w max
Globe	Not included
Warranty	1 year*

Colours

Grey/white

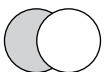

Measurements

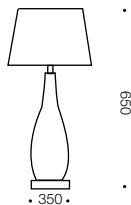

Codes

Milo TL-GY/WH

Product Approvals



Tamar

Table Lamp



Specifications

Type	Table Lamp
Light Source	E27 40w max
Globe	Not included
Warranty	1 year*

Measurements

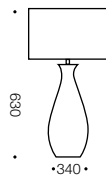

Colours

Black/gold/black



Black/silver/grey



Blue/white/white



Codes

Tamar TL-BKG/BK

Tamar TL-BKG/GY

Tamar TL-BLW/WH

Product Approvals



Panto

Table Lamp



Specifications

Type	Table Lamp
Light Source	E27 40w max
Globe	Not included
Warranty	1 year*

Measurements

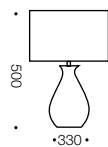

Colours

Black/gold/black



Black/silver/grey



Blue/white/white

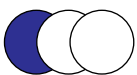

Codes

Panto TL-BKG/BK

Panto TL-BKS/GY

Panto TL-BKW/WH

Product Approvals



Selma

Table Lamp



Specifications

Type	Table Lamp
Light Source	E14 25w max
Globe	Not included
Warranty	1 year*

Colours

White/grey

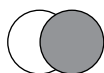

Measurements

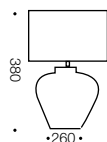

Codes

Selma TL-WH/GY

Product Approvals



Olga

Table Lamp



Specifications

Type	Table Lamp
Light Source	25w E14max
Globe	Not included
Warranty	1 year*

Measurements

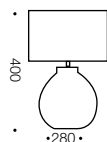

Colours

Grey/white



Codes

Olga TL-GY/WH

Product Approvals



Neta

Table Lamp



Specifications

Type	Table Lamp
Light Source	25w E14max
Globe	Not included
Warranty	1 year*

Colours

Coffee/grey

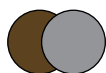

Measurements

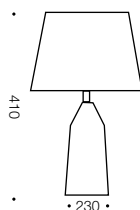

Codes

Neta TL-CF/GY

Product Approvals





Orson

Table Lamp



Specifications

Type	Table Lamp
Light Source	E27 40w max
Globe	Not included
Warranty	1 year*

Measurements

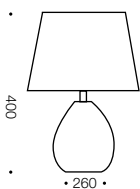

Colours

Black/black



Cream/vanilla



White/marble



Codes

Orson TL-BK/BK

Orson TL-CR/VN

Orson TL-WH/WH

Product Approvals



Miren

Table Lamp



Specifications

Type	Table Lamp
Light Source	25w E14max
Globe	Not included
Warranty	1 year*

Measurements

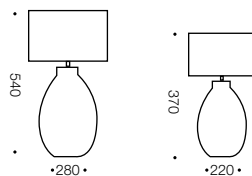

Colours

White red/white



Codes

Miren TLL-RD/WH

Miren TLS-RD/WH

Product Approvals



Padma

Table Lamp



Specifications

Type	Table Lamp
Light Source	25w E14max
Globe	Not included
Warranty	1 year*

Measurements

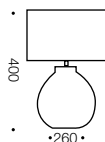

Colours

Blue/white



Codes

Padma TL-BL/WH

Product Approvals



Shani

Table Lamp



Specifications

Type	Table Lamp
Light Source	25w E14max
Globe	Not included
Warranty	1 year*

Measurements

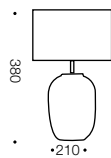

Colours

White leaf/white



Codes

Shani TL-WH/WH

Product Approvals



Amani

Table Lamp



Specifications

Type	Table Lamp
Light Source	25w E14max
Globe	Not included
Warranty	1 year*

Colours

Blue/gold



Measurements

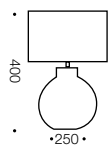

Codes

Amani TL-BL/GD

Product Approvals



Bosco

Table Lamp



Specifications

Type	Table Lamp
Light Source	E27 40w max
Globe	Not included
Warranty	1 year*

Colours

Beige/beige



Measurements

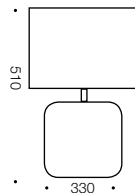

Codes

Bosco TL-BE/BE

Product Approvals

IP20



Axis

Table Lamp



Specifications

Type	Table Lamp
Light Source	E27 40w max
Globe	Not included
Warranty	1 year*

Measurements

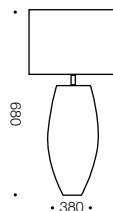

Colours

Cream/beige

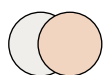

Marble/white

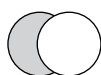

Codes

Axis TL-CR/BE

Axis TL-NK/WH

Product Approvals



Esmo

Table Lamp



Specifications

Type	Table Lamp
Light Source	E27 40w max
Globe	Not included
Warranty	1 year*

Colours

White/white



Measurements

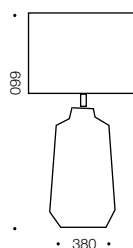

Codes

Esmo TL-WH/WH

Product Approvals

IP20



Flyn

Table Lamp



Specifications

Type	Table Lamp
Light Source	E27 40w max
Globe	Not included
Warranty	1 year*

Measurements

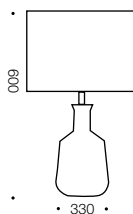

Colours

Blue/blue



Codes

Flyn TL-BL/BL

Product Approvals



Jonah

Table Lamp



Specifications

Type	Table Lamp
Light Source	E27 40w max
Globe	Not included
Warranty	1 year*

Measurements

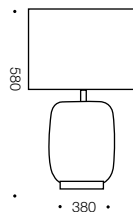

Colours

Blue/white

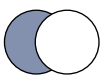

Codes

Jonah TL-BLWH

Product Approvals



Hulong

Table Lamp



Specifications

Type	Table Lamp
Light Source	E27 40w max
Globe	Not included
Warranty	1 year*

Colours

Blue Flower/white



Measurements

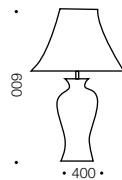

Codes

Hulong TL-BLF/WH

Product Approvals



Nakato

Table Lamp



Specifications

Type	Table Lamp
Light Source	25w E14max
Globe	Not included
Warranty	1 year*

Measurements

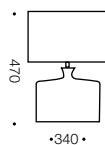

Colours

Blue/white



Codes

Nakato TL-BL/WH

Product Approvals



Ling

Table Lamp



Specifications

Type	Table Lamp
Light Source	25w E14max
Globe	Not included
Warranty	1 year*

Colours

Blue/white



Measurements

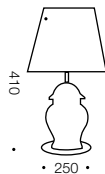

Codes

Ling TL-BLWH

Product Approvals

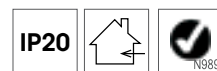

Lantau

Table Lamp



Specifications

Type	Table Lamp
Light Source	E27 40w max
Globe	Not included
Warranty	1 year*

Colours

Flower/gold



Measurements

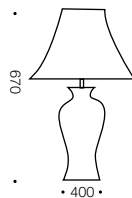

Codes

Lantau TL-FLW/GD

Product Approvals



Shibo

Table Lamp



Specifications

Type	Table Lamp
Light Source	E27 40w max
Globe	Not included
Warranty	1 year*

Colours

Bird/cream



Measurements

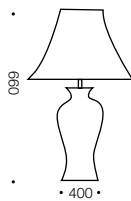

Codes

Shibo TL-FLW/CR

Product Approvals



Nashi

Table Lamp



Specifications

Type	Table Lamp
Light Source	E27 40w max
Globe	Not included
Warranty	1 year*

Measurements

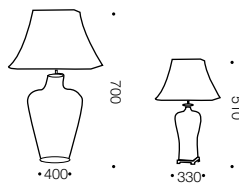

Colours

Antique brass/dark blue base
with taupe shade



Codes

Nashi TL33-BL

Nashi TL40-BL

Product Approvals



Dono

Table Lamp



Specifications

Type	Table Lamp
Light Source	E27 40w max
Globe	Not included
Warranty	1 year*

Measurements

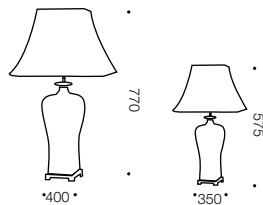

Colours

Chrome/grey/white floral base with white shade



Codes

Dono TL35-GRY

Dono TL40-GRY

Product Approvals





Vivian

Table Lamp



Specifications

Type	Table Lamp
Light Source	E14 40w max
Globe	Not included
Warranty	1 year*

Measurements



Colours

Chrome/white

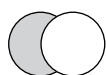

Gold/white

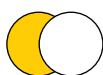

Codes

Vivian TL-CH/WH

Vivian TL-GD/WH

Product Approvals



Sigrid

Table Lamp



Specifications

Type	Table Lamp
Light Source	E27 40w max
Globe	Not included
Warranty	1 year*

Colours

Chrome/clear/white



Gold/clear/black



Measurements

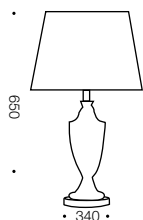

Codes

Sigrid TL-CHWH

Sigrid TL-GDBK

Product Approvals

IP20



N989

Wilton

Table Lamp



Specifications

Type	Table Lamp
Light Source	E27 40w max
Globe	Not included
Warranty	1 year*

Measurements

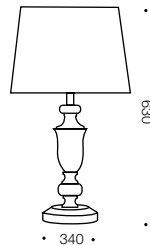

Colours

Antique brass/gold Nickel/cream

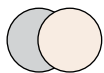
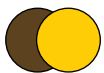

Codes

Wilton TL-ABGD

Wilton TL-NKCRM

Product Approvals

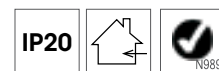

Adria

Table Lamp



Specifications

Type	Table Lamp
Light Source	E27 40w max
Globe	Not included
Warranty	1 year*

Measurements



Colours

Chrome/clear/white

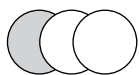

Gold/clear/black



Codes

Adria TL-CHWH

Adria TL-GDBK

Product Approvals

IP20



N989

Whitney

Table Lamp



Specifications

Type	Table Lamp
Light Source	E27 40w max
Globe	Not included
Warranty	1 year*

Measurements

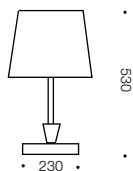

Colours

Antique brass/gold

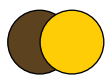

Gold/white

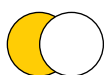

Nickel/silver

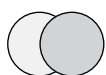

Codes

Whitney TL-AB/GD

Whitney TL-GD/WH

Whitney TL-NK/SL

Product Approvals

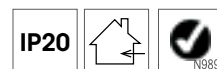

Eden

Table Lamp



Specifications

Type	Table Lamp
Light Source	E27 40w max
Globe	Not included
Warranty	1 year*

Measurements

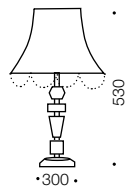

Colours

Chrome/white

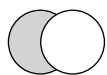

Gold/white

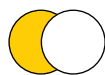

Codes

Eden TL-CH/WH

Eden TL-GDWH

Product Approvals



Regina

Table Lamp



Specifications

Type	Table Lamp
Light Source	E27 40w max
Globe	Not included
Warranty	1 year*

Measurements

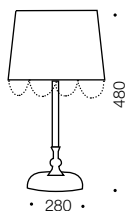

Colours

Chrome/white



Gold/cream



Codes

Regina TL-CH/WH

Regina TL-GD/CRM

Product Approvals





Adair

Table Lamp



Specifications

Type	Table Lamp
Light Source	E27 25w max
Globe	Not included
Warranty	1 year*

Measurements

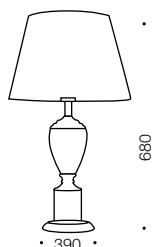

Colours

Antique brass/amber/vanilla



Nickel/clear/white



Codes

Adair TL-NKCLWH

Adair TL-ABAMVN

Product Approvals



Baxter

Table Lamp



Specifications

Type	Table Lamp
Light Source	E27 40w max
Globe	Not included
Warranty	1 year*

Measurements

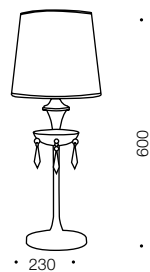

Colours

Antique brass/cream

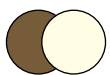

Chrome/white

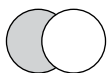

Codes

Baxter TL-AB

Baxter TL-CH

Product Approvals



Molera

Table Lamp



Specifications

Type	Table Lamp
Light Source	E27 60w max
Globe	Not included
Warranty	1 year*

Colours

Antique walnut/beige



Measurements

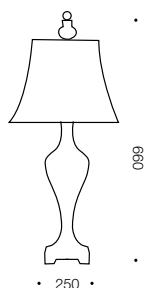

Codes

Molera TL-AW

Product Approvals



Plaza

Table Lamp



Specifications

Type	Table Lamp
Light Source	E27 40w max
Globe	Not included
Warranty	1 year*

Measurements

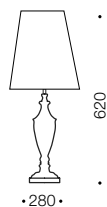

Colours

Black matt/natural linen print



Codes

Plaza TL-BK/NT

Product Approvals



Arlene

Table Lamp



Specifications

Type	Table Lamp
Light Source	E27 40w max
Globe	Not included
Warranty	1 year*

Colours

Chrome/pearl/print shade



Measurements

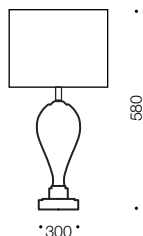

Codes

Arlene TL-CH/PRT

Product Approvals



Loreto

Table Lamp



Specifications

Type	Table Lamp
Light Source	E27 40w max
Globe	Not included
Warranty	1 year*

Measurements

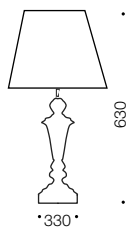

Colours

Chrome/grey print



Codes

Loreto TL-CH/GR

Product Approvals



Hildy

Table Lamp



Specifications

Type	Table Lamp
Light Source	E27 40w max
Globe	Not included
Warranty	1 year*

Colours

Gunmetal/grey black flower



Measurements

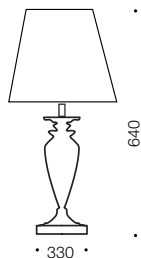

Codes

Hildy TL-GM/GR

Product Approvals





Tribe

Floor, Table Lamp & Pendant



Specifications

Type	Floor & Table Lamps
Light Source	E27 40w max
Globe	Not included
Warranty	1 year*

Colours

Brown/white

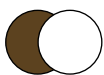

Measurements

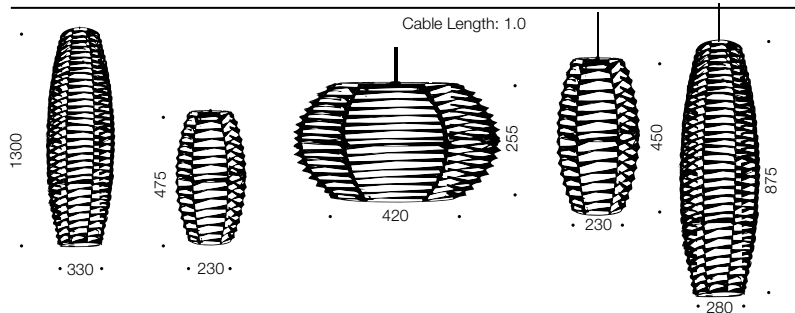

Codes

Tribe PE23-BN	Tribe PE23-WH
Tribe PE28-BN	Tribe PE28-WH
Tribe PE42-BN	Tribe PE42-WH
Tribe FL-BN	Tribe FL-WH
Tribe TL-BN	Tribe TL-WH

Product Approvals



Cosi

Table Lamp



Specifications

Type	Table Lamp
Light Source	E27 60w max
Globe	Not included
Warranty	1 year*

Colours

Chrome/silver



Measurements

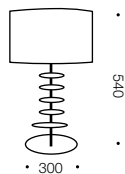

Codes

Cosi TL-CH/SL

Product Approvals



Felipa

Table Lamp



Specifications

Type	Table Lamp
Light Source	E27 60w max
Globe	Not included
Warranty	1 year*

Colours

Black/oak



Measurements

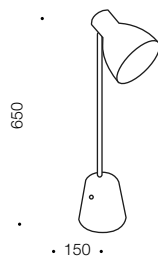

Codes

Felipa TL-BK

Product Approvals



Boston

Table Lamp



Specifications

Type	Table Lamp
Light Source	E27 75w max
Globe	Not included
Warranty	1 year*

Measurements

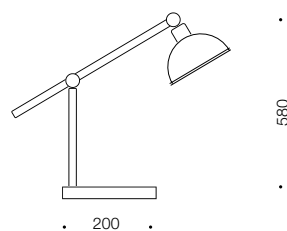

Colours

Antique brass/oak



Codes

Boston TL-AB

Product Approvals



Holger

Table Lamp



Specifications

Type	Table Lamp
Light Source	E27 25w max
Globe	Not included
Warranty	1 year*

Colours

Nickel/oak



Measurements

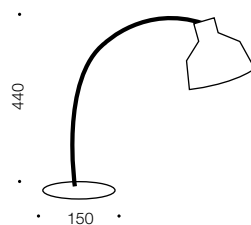

Codes

Holger TL-NK/OK

Product Approvals

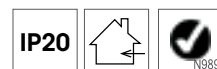

Sala

Table Lamp



Specifications

Type	Table Lamp
Light Source	E27 40w max
Globe	Not included
Warranty	1 year*

Colours

Nickel/white linen

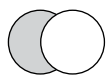

Measurements

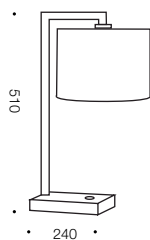

Codes

Sala TL-NK/WH

Product Approvals



Edson

Table Lamp



Specifications

Type	Table Lamp
Light Source	E27 40w max
Globe	Not included
Warranty	1 year*

Colours

Nickel/white

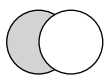

Measurements

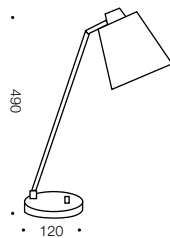

Codes

Edson TL-NK/WH

Product Approvals





Tyler

Floor & Table Lamp



Specifications

Type	Table / Floor Lamp
Light Source	LED
Lumen	500
Colour Temp	3000k
Wattage	6w
Dimmable	No
CRI	>80
Power Factor	>0.9
Beam Angle	120
Warranty	2 year*

Colours

Black/nickel/white



Codes

Tyler FL-BK	Tyler TL-BK
Tyler FL-NK	Tyler TL-NK
Tyler FL-WH	Tyler TL-WH

Measurements

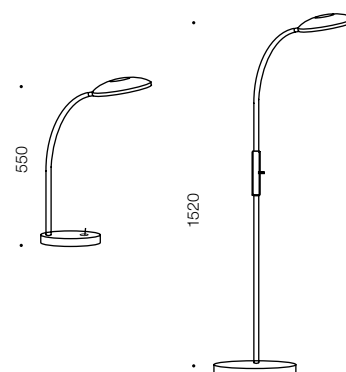

Product Approvals



Bart

Table Lamp



Specifications

Type	Table Lamp
Light Source	E27 40w max
Globe	Not included
Warranty	1 year*

Colours

Chrome/black

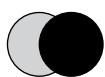

Chrome/white

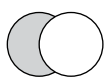

Antique brass/cream



Measurements

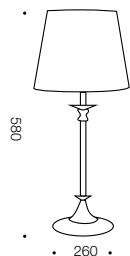

Codes

Bart TL-AB/CRM

Bart TL-CH/BK

Bart TL-CH/WH

Product Approvals

IP20



Baja

Floor & Table Lamp



Specifications

Type	Floor & Table Lamps
Light Source	E27 40w max
Globe	Not included
Warranty	1 year*

Colours

Black/red/white



Measurements

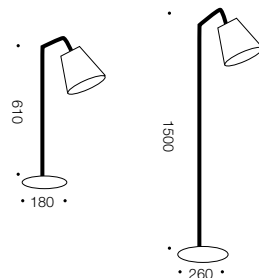

Codes

Baja TL-BK

Baja TL-RD

Baja FL-WH

Baja FL-RD

Product Approvals



Apex

Table Lamp



Specifications

Type	Table Lamp
Light Source	LED
Lumen	400
Colour Temp	3000k
Wattage	5w
Dimmable	No
CRI	>80
Power Factor	>0.9
Beam Angle	140
Warranty	2 year*

Colours

Silver/red

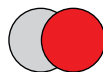

Codes

Apex TL-SL

Apex TL-RD

Measurements

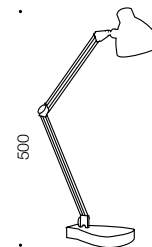

Product Approvals



Forum

Table Lamp



Specifications

Type	Table Lamp
Light Source	LED
Lumen	400
Colour Temp	4000k
Wattage	5w
Dimmable	No
CRI	>80
Power Factor	>0.9
Beam Angle	140
Warranty	2 year*

Colours

Aluminium



Codes

Forum TL-AL

Measurements

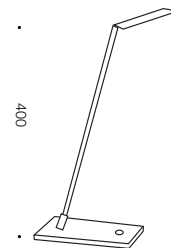

Product Approvals



Beat

Floor Lamp



Specifications

Type	Floor Lamp
Light Source	E27 40w max
Globe	Not included
Warranty	1 year*

Colours

Black/chrome/white

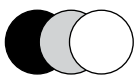

Measurements

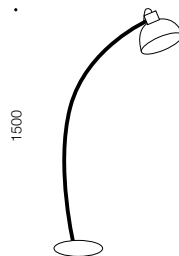

Codes

Beat FL-BK

Beat FL-CH

Beat FL-WH

Product Approvals



Fiona

Floor, Table Lamp & Pendant



Specifications

Type	Floor, Table Lamps & Pendant
Light Source	E27 40w max
Globe	Not included
Warranty	1 year*

Colours

Oak/white-nickel



Measurements

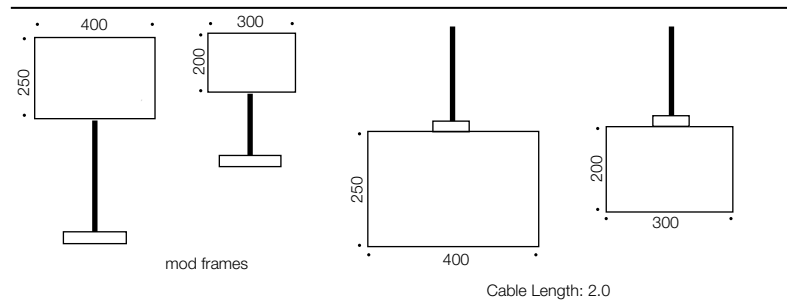

Codes

Fiona PE30-OAKWH

Fiona PE40-OAKWH

Fiona TL30-OAKWH

Fiona TL40-OAKWH

Fiona FL30-OAKWH

Fiona FL40-OAKWH

Product Approvals





Dorian

Table Lamp



Specifications

Type	Table Lamp
Light Source	G9 40w max
Globe	Included
Dimmable	Yes
Warranty	1 year*

Colours

Chrome/opal matt Gunmetal/opal matt



Measurements

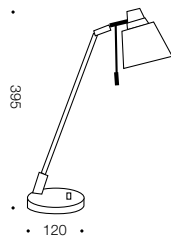

Codes

Dorian TL-GM

Dorian TL-CH

Product Approvals



Oxford

Floor & Table Lamp



Specifications

Type	Floor & Table Lamp
Light Source	E27 40w max
Globe	Not included
Warranty	1 year*

Colours

Antique gold/gold

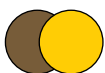

Measurements

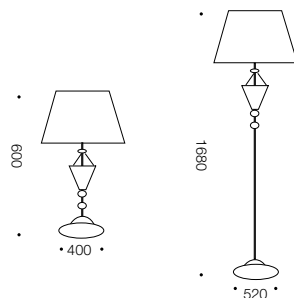

Codes

Oxford FL-AG/GD

Oxford TL-AG/GD

Product Approvals



Joy

Floor Lamp



Specifications

Type	Floor Lamp
Light Source	LED
Lumen	1600
Colour Temp	4000k
Wattage	20w/20+5w
Dimmable	Yes
CRI	>80
Power Factor	>0.9
Beam Angle	120
Warranty	2 year*

Colours

Nickel



Measurements

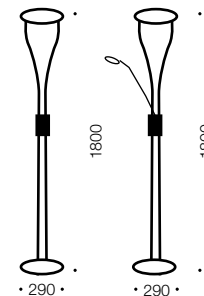

Codes

Joy FL-NK

Joy FL M&S-NK

Product Approvals

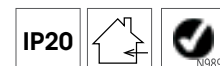

Denise

Floor & Table Lamp



Specifications

Type	Floor & Table Lamp
Light Source	E27 75w max
Globe	Not included
Warranty	1 year*

Colours

Black/black



Chrome/red

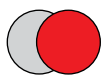

Chrome/white

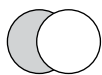

Measurements

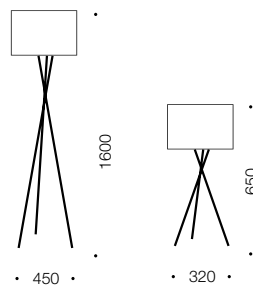

Codes

Denise FL
BK/BK

Denise TL
BK/BK

Denise FL
CH/RD

Denise TL
CH/RD

Denise FL
CH/WH

Denise TL
CH/WH

Product Approvals



Emily

Floor & Table Lamp



Specifications

Type	Floor & Table Lamp
Light Source	E27 40w max
Globe	Not included
Warranty	1 year*

Colours

Beech/vanilla

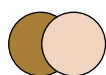

Measurements

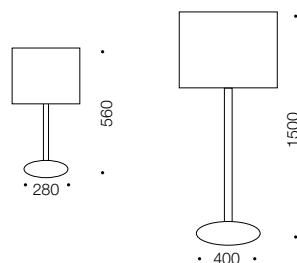

Codes

Emily FL-BCH/VN

Emily TL-BCH/VN

Product Approvals





Bomp

Table Lamp



Specifications

Type	Table Lamp
Light Source	LED SMD
Lumen	260
Colour Temp	4000k
Wattage	3.2w
Dimmable	No
CRI	>80
Power Factor	>0.9
Beam Angle	140
Warranty	2 year*

Colours

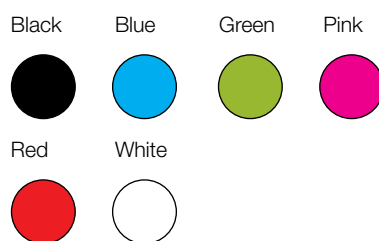

Codes

Bomp TL-BK	Bomp TL-GR
Bomp TL-BL	Bomp TL-PK
Bomp TL-RD	Bomp TL-WH

Measurements

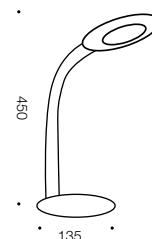

Product Approvals



Mardi

Table Lamp



Specifications

Type	Table Lamp
Light Source	E14 25w max
Globe	Not included
Warranty	1 year*

Measurements

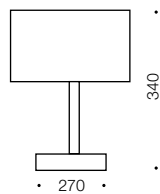

Colours

Black/nickel



White/nickel



Codes

Mardi TL-BK

Mardi TL-WH

Product Approvals



Adam

Table Lamp



Specifications

Type	Table Lamp
Light Source	E27 40w max
Globe	Not included
Warranty	1 year*

Measurements



Colours

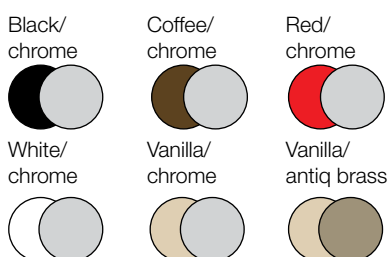

Codes

Adam TL-BK	Adam TL-WH
Adam TL-CF	Adam TL-VN
Adam TL-RD	Adam TL-AB/ VN

Product Approvals



Glade

Table Lamp



Specifications

Type	Table Lamp
Light Source	E14 40w max
Globe	Not included
Warranty	1 year*

Measurements

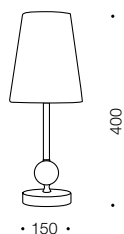

Colours

Black/chrome



Red/chrome

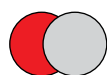

Codes

Glade TL-BK

Glade TL-RD

Product Approvals

IP20



Jasmine

Table Lamp



Specifications

Type	Table Lamp
Light Source	E27 40w max
Globe	Not included
Warranty	1 year*

Colours

Chrome/grey

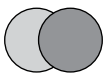

Measurements

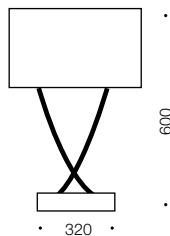

Codes

Jasmine TL-CH/GY

Product Approvals



Biscay

Table Lamp



Specifications

Type	Table Lamp
Light Source	E27 60w max
Globe	Not included
Warranty	1 year*

Colours

Chrome/clear-white

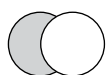

Measurements



Codes

Biscay TL-WH

Product Approvals



Evelyn

Table Lamp



Specifications

Type	Table Lamp
Light Source	E27 60w max
Globe	Not included
Warranty	1 year*

Colours

Smoke glass/chrome/tobacco shade

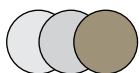

Measurements



Codes

Evelyn TL-CH/TBC

Product Approvals





Covina

Table Lamp



Specifications

Type	Table Lamp
Light Source	E27 40w max
Globe	Not included
Warranty	1 year*

Measurements

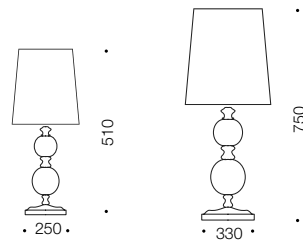

Colours

Chrome/mosaic/gold



Codes

Covina TLS-CH/GD

Covina TLL-CH/GD

Product Approvals



Diana

Table Lamp



Specifications

Type	Table Lamp
Light Source	E27 40w max
Globe	Not included
Warranty	1 year*

Measurements

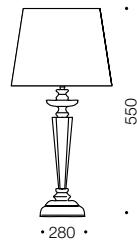

Colours

Gold/crystal/white

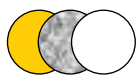

Chrome/crystal/white



Codes

Diana TL-CH/WH

Diana TL-GD/WH

Product Approvals



Sandy

Table Lamp



Specifications

Type	Table Lamp
Light Source	E27 40w max
Globe	Not included
Warranty	1 year*

Measurements

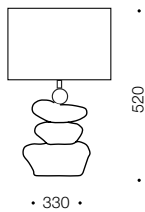

Colours

Stone/grey linen

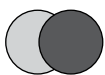

Codes

Sandy TL-ST/GR

Product Approvals

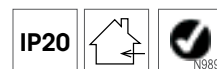

Ohio

Table Lamps



Specifications

Type	Table Lamp
Light Source	E27 60w max
Globe	Not included
Warranty	1 year*

Measurements

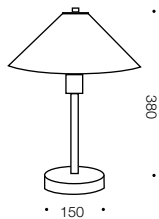

Colours

Antique brass/
opal matt glass



Nickel/
opal matt glass



Codes

Ohio TL AB

Ohio TL NK

Product Approvals



Sax

Table Lamp



Specifications

Type	Table Lamp
Light Source	E27 40w max
Globe	Not included
Warranty	1 year*

Colours

Nickel/white

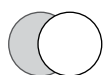

Measurements

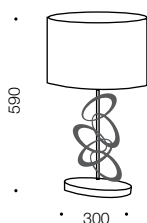

Codes

Sax TL-NK

Product Approvals



Torres

Floor Lamp



Specifications

Type	Floor Lamp
Light Source	E27 60w max
Globe	Not included
Warranty	1 year*

Colours

Nickel/antique brass

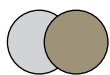

Measurements

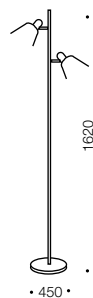

Codes

Torres FL2-AB

Torres FL2-NK

Product Approvals



Angus

Table Lamp



Specifications

Type	Table Lamp
Light Source	E27 60w max
Globe	Not included
Warranty	1 year*

Colours

Nickel/opal matt glass

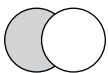

Measurements

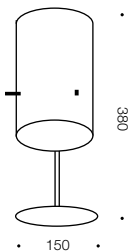

Codes

Angus TL NK

Product Approvals

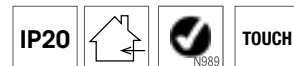

Abode Series

Metalware



Tag 27 Table Lamp
60w max E27
H: 270 D: 180
CHROME

Tag 35 Table Lamp
60w max E27
H: 350 D: 230
CHROME

4



Mod 27 Table Lamp
60w max E27
H: 270 D: 150
NICKEL

4

Mod 35 Table Lamp
60w max E27
H: 350 D: 200
NICKEL

4



Harp 21
210 x 90
CHROME/NICKEL

4



Mod Pendant
60w max E27
H:290 + 1200
NICKEL

4

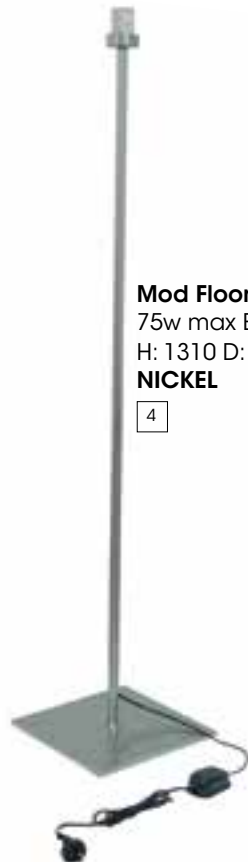

Mod Floor Lamp
75w max E27
H: 1310 D: 280
NICKEL

4



Lob Floor Lamp
75w max E27
H:1830
CHROME
NICKEL/BLACK base

1

1830

projection size 85



The abode collection of metal lamp frames offers endless combinations of individual personality when married with the lampshade series. Inspired by modern design with emphasis and attention to quality manufacture.

4 = PACKING SIZE

Durum

Shade

Specifications

Type	Shade
Warranty	1 year*

Measurements



250 x 250 x 235
350 x 350 x 320
450 x 450 x 400

Colours

RA-Raisin



RU-Ruby



Codes

SH Durum 25 RU

SH Durum 35 RA

SH Durum 45 RA

SH Durum 45 RU

Product Approvals



Soft

Shade

Specifications

Type	Shade
Warranty	1 year*

Measurements



300 x 400 x 350

Colours

BK-Black



WH-White



Codes

SH Soft 40 BK

SH Soft 40 WH

Product Approvals

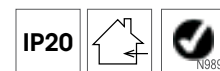

Flora

Shade

Specifications

Type	Shade
Warranty	1 year*

Measurements



200 x 200 x 200

300 x 300 x 225

Colours

Coffee

White

Black



Codes

SH Flora 20 WH

SH Flora 30 BK

SH Flora 30 CF

SH Flora 30 WH

Product Approvals

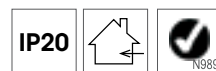

Satin

Shade

Specifications

Type	Shade
Warranty	1 year*

Measurements



145 x 250 x 180

200 x 350 x 225

Colours

Red



Codes

SH Satin 25 RD

SH Satin 35 RD

Product Approvals

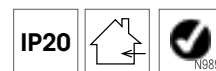

Lacey

Shade

Specifications

Type	Shade
Warranty	1 year*

Measurements



200 x 200 x 175
300 x 300 x 225
400 x 400 x 285

Colours

Gold



Silver



Codes

SH Lacey 20 GD

SH Lacey 30 GD

SH Lacey 40 SIL

SH Lacey 40 SIL

Product Approvals



Carbon

Shade

Specifications

Type	Shade
Warranty	1 year*

Measurements



300 x 300 x 300
450 x 450 x 450

Colours

Cocoa



White



Codes

SH Carbon 30 CO

SH Carbon 30 WH

SH Carbon 45 WH

Product Approvals



Quad Shade

Specifications

Type	Shade
Warranty	1 year*

Measurements



180 x 210 x 180
240 x 280 x 240
320 x 380 x 340

Colours

Black



White



Codes

SH Quad 21 WH

SH Quad 28 BK

SH Quad 28 WH

SH Quad 38 WH

Product Approvals

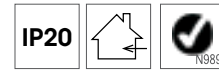

String Shade

Specifications

Type	Shade
Warranty	1 year*

Measurements



170 x 230 x 195
300 x 400 x 350

Colours

Red



Silver



Black



Codes

SH String 23 RD

SH String 30 BK

SH String 30 RD

SH String 30 SIL

SH String 40 BK

Product Approvals



Wall Lamp/Vanity



Elba

Wall Lamp/Vanity



Specifications

Type	Wall Lamp
Light Source	LED
Lumen	600/620 800/850 1200/1250
Colour Temp	3000K/5000k
Wattage	8w/12w/18w
Dimmable	No
CRI	>80
Power Factor	>0.9
Beam Angle	140
Warranty	2 year*

Colours

Nickel/opal



Codes

Elba 08.425-NK83

Elba 08.425-NK85

Elba 12.565-NK83

Elba 12.565-NK85

Elba 18.900-NK83

Elba 18.900-NK85

Measurements

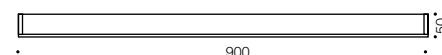
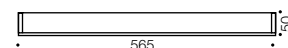
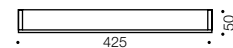

Product Approvals



Oras

Wall Lamp/Vanity



Specifications

Type	Wall Lamp
Light Source	LED
Lumen	800/850 1200/1250 1600/1680
Colour Temp	3000K/5000k
Wattage	12w/18w/24w
Dimmable	No
CRI	>80
Power Factor	>0.9
Beam Angle	140
Warranty	2 year*

Colours

Chrome/opal



Codes

Oras 12.420-CH83

Oras 12.420-CH85

Oras 18.665-CH83

Oras 18.665-CH85

Oras 24.975-CH83

Oras 24.975-CH85

Measurements

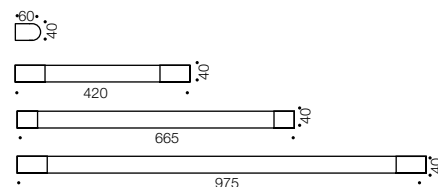

Product Approvals



Heston

Wall Lamp/Vanity



Specifications

Type	Wall Lamp
Light Source	LED
Lumen	320 per unit
Colour Temp	4000K
Wattage	4w per globe
Dimmable	No
CRI	>80
Power Factor	>0.9
Beam Angle	140
Warranty	2 year*

Colours

Clear/chrome



Codes

Heston WB1-CH

Heston WB2-CH

Heston WB2A-CH

Heston WB3-CH

Heston WB4-CH

Measurements

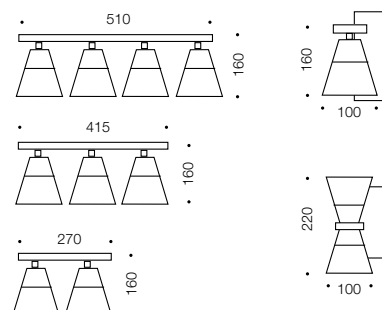

Product Approvals



Axel

Wall Lamp/Vanity



Specifications

Type	Wall Lamp
Light Source	LED
Lumen	360 per globe
Colour Temp	4000K
Wattage	4.5w per globe
Dimmable	No
CRI	>80
Power Factor	>0.9
Beam Angle	140
Warranty	2 year*

Colours

Chrome/frost



Codes

Axel 1-CH/FR

Axel 2B-CH/FR

Axel 3B-CH/FR

Axel 4B-CH/FR

Measurements

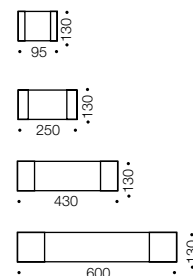

Product Approvals



Cordia

Wall Lamp



Specifications

Type	Wall Lamp
Light Source	LED
Lumen	700/1100
Colour Temp	4000k
Wattage	12w/20w
Dimmable	No
CRI	>80
Power Factor	>0.9
Beam Angle	120
Warranty	2 year*

Colours

Aluminium



Measurements

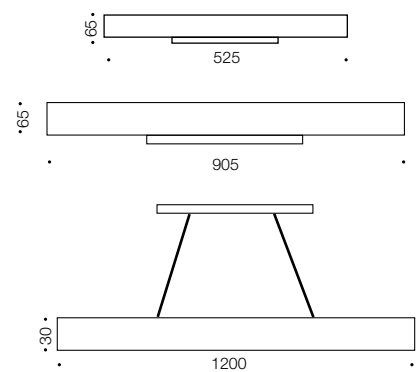

Codes

Cordia PE120-AL

Cordia WB52-AL

Cordia WB90-AL

Product Approvals



Kim

Wall Lamp/Vanity



Specifications

Type	Wall Lamp
Light Source	LED
Lumen	500/750
Colour Temp	3000k
Wattage	8w/12w
Dimmable	No
CRI	>80
Power Factor	>0.9
Beam Angle	140
Warranty	2 year*

Colours

Chrome/frost

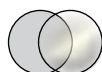

Measurements

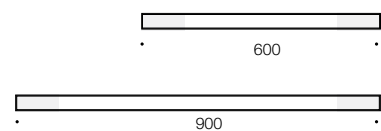

Codes

Kim WB60-CH

Kim WB90-CH

Product Approvals





Pena

Wall Lamp

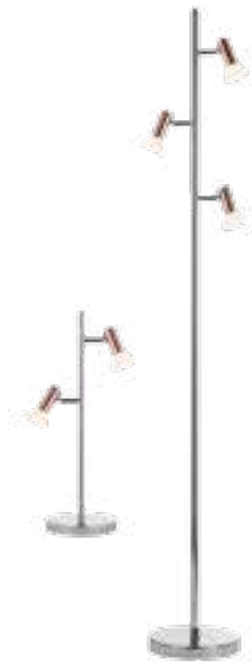

Specifications

Type	Wall Lamp
Light Source	LED
Lumen	320
Colour Temp	4000k
Wattage	5w
Dimmable	No
CRI	>80
Power Factor	>0.9
Beam Angle	120
Warranty	2 year*

Colours

Copper/chrome

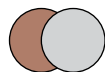

Codes

Pena FL3-CP/CH

Pena TL2-CP/CH

Pena WB1-CP/CH

Measurements

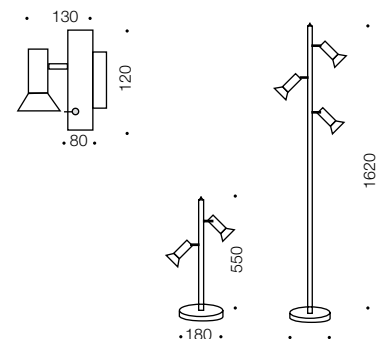

Product Approvals



Slice

Wall Lamp



Specifications

Type	Wall Lamp
Light Source	LED
Lumen	400
Colour Temp	4000k
Wattage	5w
Dimmable	No
CRI	>80
Power Factor	>0.9
Beam Angle	140
Warranty	2 year*

Colours

Aluminium



Measurements

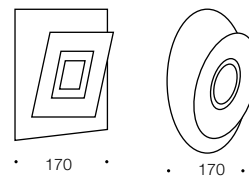

Codes

Slice WB.R-AL

Slice WB.S-AL

Product Approvals



Elsa

Wall Lamp



Specifications

Type	Wall Lamp
Light Source	LED
Lumen	400
Colour Temp	4000k
Wattage	5w
Dimmable	No
CRI	>80
Power Factor	>0.9
Beam Angle	140
Warranty	2 year*

Colours

Chrome/opaline



Measurements

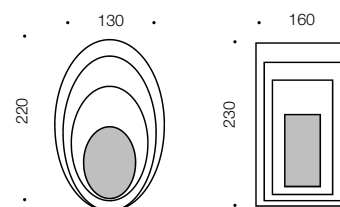

Codes

Elsa WBRD5-CH

Elsa WBSQ5-CH

Product Approvals





Stow

Stair Light



Specifications

Type	Stair Light
Light Source	LED
Lumen	200
Colour Temp	3000k/5000k
Wattage	3w
Dimmable	No
CRI	>80
Power Factor	>0.9
Beam Angle	140
Warranty	3 years*

Colours

Nickel/white/silver



Codes

Stow RD-NK. 830	Stow RD NK. 850
Stow RD-WH. 830	Stow RD-WH. 850
Stow SQ-SL. 830	Stow SQ-SL. 850
Stow SQ-WH. 830	Stow SQ-WH. 850

Measurements

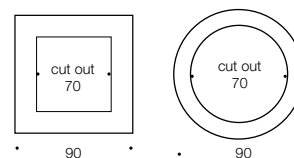

Product Approvals



Puka

Wall Lamp



Specifications

Type	Wall Lamp
Light Source	2w G9-240v 4000k
Globe	Included
Dimmerable	No
Warranty	1 year*

Colours

Aluminium/frost glass

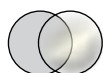

Measurements

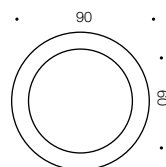

Codes

Puka WLRD-AL

Product Approvals



Snap

Stair Light



Specifications

Type	Stair Light
Light Source	LED
Lumen	200
Colour Temp	4000k
Wattage	3w
Dimmable	No
CRI	>80
Power Factor	>0.9
Beam Angle	140
Warranty	2 years*

Colours

Nickel/white



Measurements

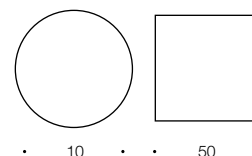

Codes

Snap RD-WH

Snap SQ-WH

Product Approvals



Nemo

Wall Lamp



Specifications

Type	Wall Lamp
Light Source	60w E27max
Globe	Not included
Warranty	1 year*

Colours

Nickel/clear frost glass

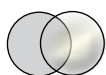

Measurements

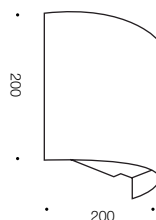

Codes

Nemo WB 1

Product Approvals



Beliza

Wall Lamp

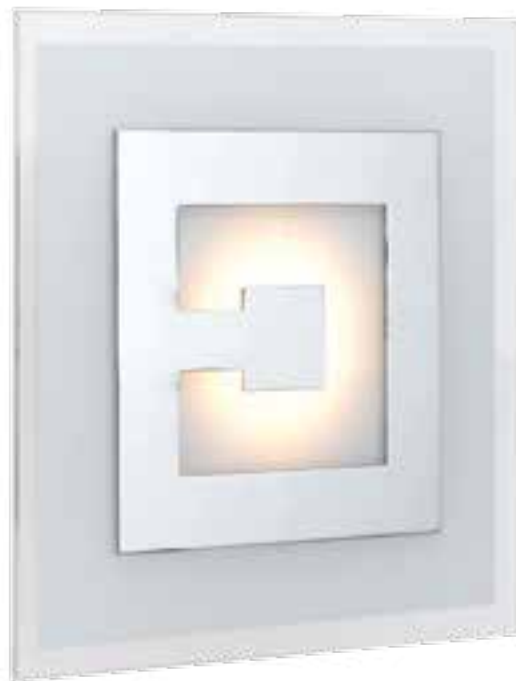

Specifications

Type	Wall Lamp
Light Source	LED
Lumen	400/640
Colour Temp	4000K
Wattage	5w / 8w
Dimmable	No
CRI	>80
Power Factor	>0.9
Beam Angle	140
Warranty	2 year*

Colours

Chrome/frost/clear

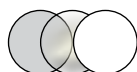

Measurements

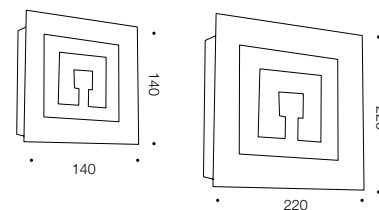

Codes

Beliza WB5-CH

Beliza WB8-CH

Product Approvals



Umbo

Wall Lamp



Specifications

Type	Wall Lamp
Light Source	40w E14max
Globe	Not included
Warranty	1 year*

Colours

Nickel/opaline

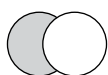

Measurements

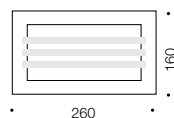

Codes

Umbo WB1-NK

Product Approvals



Mateo

Wall Lamp



Specifications

Type	Wall Lamp
Light Source	LED
Lumen	500/800
Colour Temp	4000k
Wattage	6w/10w
Dimmable	No
CRI	>80
Power Factor	>0.9
Beam Angle	140
Warranty	2 year*

Colours

Aluminium



Codes

Mateo WB10-ALM

Measurements

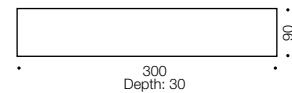
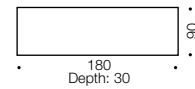

Product Approvals



Wave

Wall Lamp



Specifications

Type	Wall Lamp
Light Source	LED
Lumen	250
Colour Temp	4000k
Wattage	3w
Dimmable	No
CRI	>80
Power Factor	>0.9
Beam Angle	140
Warranty	2 year*

Colours

Chrome/white

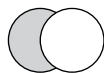

Measurements

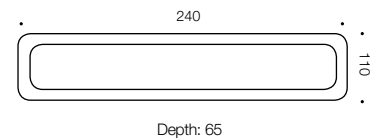

Codes

Wave WB003-FR

Product Approvals



Aria

Wall Lamp



Specifications

Type	Wall Lamp
Light Source	LED
Lumen	250
Colour Temp	3000k
Wattage	5w
Dimmable	No
CRI	>80
Power Factor	>0.9
Beam Angle	140
Warranty	2 year*

Colours

Nickel/opal matt

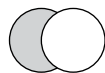

White/opal matt



Measurements

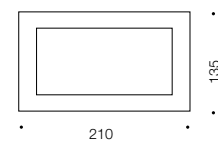

Codes

Aria WB5-NK

Aria WB5-WH

Product Approvals

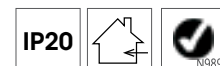

Parkin

Wall Lamp



Specifications

Type	Wall Lamp
Light Source	60w 240v E27
Globe	Not included
Warranty	1 year*

Colours

Nickel/opal matt glass

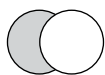

Measurements

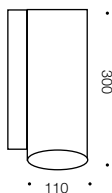

Codes

Parkin WB-NK/OM

Product Approvals



Kirk

Wall Lamp



Specifications

Type	Wall Lamp
Light Source	LED
Lumen	400
Colour Temp	4000k
Wattage	5w
Dimmable	No
CRI	>80
Power Factor	>0.9
Beam Angle	140
Warranty	2 year*

Colours

Chrome/white



Measurements

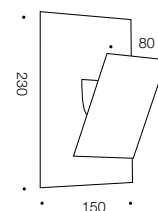

Codes

Kirk WB05-CH/WH

Product Approvals



Fargo

Wall Lamp



Specifications

Type	Wall Lamp
Light Source	40W max E27
Globe	Not included
Warranty	1 year*

Measurements

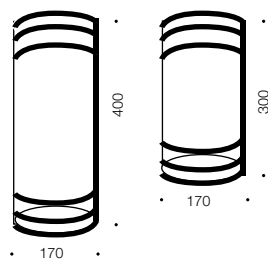

Colours

Antique brass



Codes

Fargo WB1-AB

Fargo WB2-AB

Product Approvals



Toll

Wall Lamp



Specifications

Type	Wall Lamp
Light Source	28w GU10
Globe	Included
Warranty	1 year*

Measurements

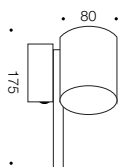

Colours

Nickel



Codes

Toll WB NK

Product Approvals





Kibo

Wall Lamp



Specifications

Type	Wall Lamp
Light Source	28w G9
Globe	Included
Warranty	1 year*

Colours

Nickel



Measurements

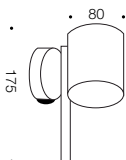

Codes

Kibo WB NK

Product Approvals



Festa

Wall Lamp



Specifications

Type	Wall Lamp
Light Source	60w max B15
Globe	Not included
Warranty	1 year*

Colours

Chrome/opaline glass

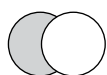

Measurements

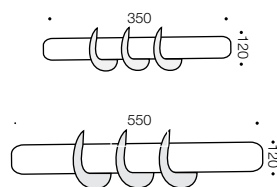

Codes

Festa 35.WB-35

Festa 55.WB-CH

Product Approvals



Gibson

Wall Lamp



Specifications

Type	Wall Lamp
Light Source	40w E27 max
Globe	Not included
Warranty	1 year*

Measurements

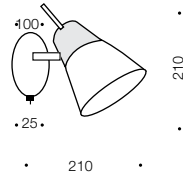

Colours

Antique brass/white marble

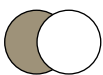

Nickel/white marble



Codes

Gibson WB-AB

Gibson WB-NK

Product Approvals

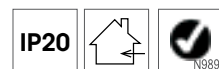

Grove

Wall Lamp



Specifications

Type	Wall Lamp
Light Source	LED
Lumen	380
Colour Temp	3000k
Wattage	7w
Dimmable	No
CRI	>80
Power Factor	>0.9
Beam Angle	.140
Warranty	2 year*

Colours

Mirror/frost

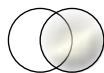

Measurements

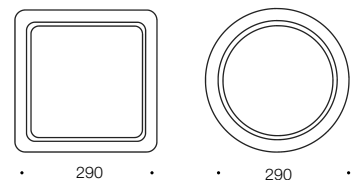

Codes

Grove WB.RD-CH

Grove WB.SQ-CH

Product Approvals



Oska

Wall Lamp



Specifications

Type	Wall Lamp
Light Source	28w G9
Globe	Included
Warranty	1 year*

Colours

Nickel/chrome with opal matt



Measurements

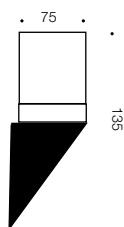

Codes

Oska WB NK

Product Approvals



Chelsea

Wall Lamp



Specifications

Type	Wall Lamp
Light Source	3x33w G9 osram
Globe	Included
Warranty	1 year*

Colours

Chrome/crystal



Measurements

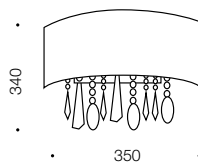

Codes

Chelsea WB3-CH

Product Approvals



Lessa

Wall Lamp



Specifications

Type	Wall Lamp
Light Source	28w G9
Globe	Included
Warranty	1 year*

Colours

Chrome/opal matt

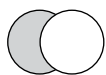

Measurements

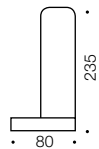

Codes

Lessa WB-CH

Product Approvals

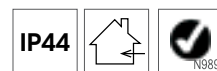

Merak

Wall Lamp



Specifications

Type	Wall Lamp
Light Source	40w max E27
Globe	Not included
Warranty	1 year*

Colours

Nickel/frost glass

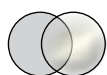

Measurements

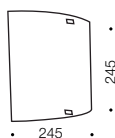

Codes

Merak WB24-NK

Product Approvals



Trill

Wall Lamp



Specifications

Type	Wall Lamp
Light Source	40w max G9
Globe	Included
Warranty	1 year*

Colours

Chrome/crystal



Measurements

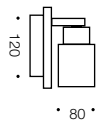

Codes

Trill WB. 1- CH

Product Approvals

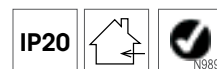

Sibel

Wall Lamp



Specifications

Type	Wall Lamp
Light Source	40w G9max
Globe	Included
Warranty	1 year*

Colours

Nickel/opal matt glass



Measurements

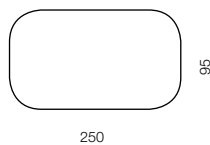

Codes

Sibel WB-OM

Product Approvals



Peg

Wall Lamp



Specifications

Type	Wall Lamp
Light Source	42w E27max
Globe	Not included
Warranty	1 year*

Colours

Opal matt/polished brass or chrome screws



Measurements

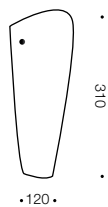

Codes

Peg WB

Product Approvals



Berlin

Wall Lamp



Specifications

Type	Wall Lamp
Light Source	40w E27max
Globe	Not included
Warranty	1 year*

Colours

Opal matt



Measurements

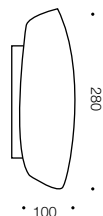

Codes

Berlin WB 28

Product Approvals



Oyster/batten

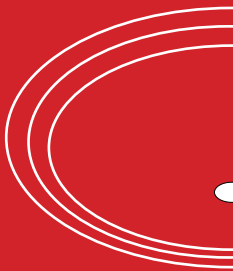



Dubai

Oyster



Specifications

Type	Oyster
Light Source	LED
Lumen	1050
Colour Temp	5000k
Wattage	18w SMD
Dimmable	No
CRI	>80
Power Factor	>0.9
Beam Angle	140
Warranty	2 years*

Colours

Chrome/frost

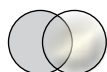

Measurements

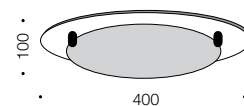

Codes

Dubai OY40-CH

Product Approvals

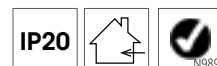

Acento

Oyster



Specifications

Type	Oyster
Light Source	LED
Lumen	1050
Colour Temp	5000k
Wattage	18w SMD
Dimmable	No
CRI	>80
Power Factor	>0.9
Beam Angle	140
Warranty	2 years*

Colours

Chrome/frost

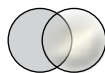

Measurements

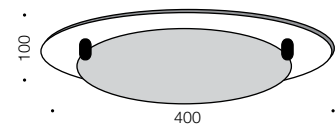

Codes

Acento OY40-CH

Product Approvals



Marisa & Lusa

Oyster



Specifications

Type	Oyster
Light Source	40w E27max
Globe	Not included
Warranty	1 year*

Measurements

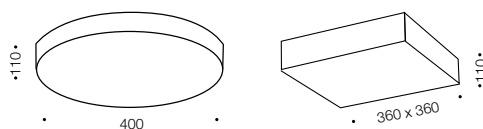

Colours

Frost/clear/chrome

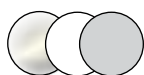

Codes

Marisa OY40-FR

Lusa OY36-FR

Product Approvals



Evan

Oyster



Specifications

Type	Oyster
Light Source	14w E27max
Globe	Not included
Warranty	1 year*

Colours

Aluminium/satin diffuser

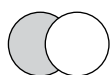

Measurements

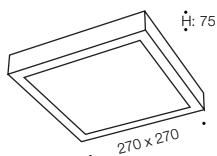

Codes

Evan OY27-AL/OM

Product Approvals



Taylor

Oyster



Specifications

Type	Oyster
Light Source	LED
Lumen	1100
Colour Temp	4000k
Wattage	16w
Dimmable	No
CRI	>80
Power Factor	>0.9
Beam Angle	140
Warranty	2 years*

Colours

Frost/clear/chrome

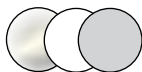

Measurements

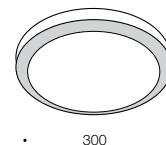

Codes

Taylor OY 16-840

Product Approvals



Riley

Oyster



Specifications

Type	Oyster
Light Source	14w E27max
Globe	Not included
Warranty	1 year*

Measurements

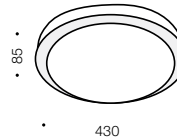
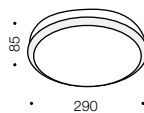

Colours

Nickel/opal matt



Codes

Riley OY29-AL/OM

Riley OY43-AL/OM

Product Approvals



Bella

Oyster



Specifications

Type	Oyster
Light Source	LED
Lumen	1100/1600
Colour Temp	4000k
Wattage	16w/22w
Dimmable	No
CRI	>80
Power Factor	>0.9
Beam Angle	140
Warranty	2 years*

Colours

Opal matt/chrome



Measurements

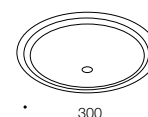
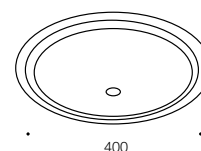

Codes

Bella OY29-AL/OM

Bella OY43-AL/OM

Product Approvals

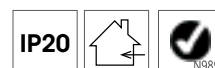

Bortoli

Oyster



Specifications

Type	Oyster
Light Source	LED
Lumen	1800
Colour Temp	4000k
Wattage	28w
Dimmable	Yes
CRI	>80
Power Factor	>0.9
Beam Angle	140
Warranty	2 year*

Colours

Chrome/crystal



Measurements

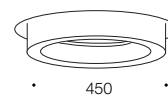

Codes

Bortoli OY45-CH

Product Approvals



Glim

Oyster



Specifications

Type	Oyster
Light Source	LED
Lumen	1000/1500/1900
Colour Temp	5000k
Wattage	16w/22w/28w
Dimmable	No
CRI	>80
Power Factor	>0.9
Beam Angle	140
Warranty	2 years*

Colours

Satin



Measurements

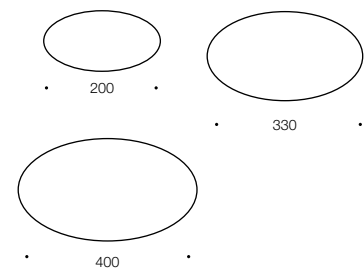

Codes

Glim OY16.260-85

Glim OY22.350-85

Glim OY28.400-85

Product Approvals



Astrid

Oyster



Specifications

Type	Oyster
Light Source	LED
Lumen	1200/1700
Colour Temp	5000k
Wattage	16w/22w
Dimmable	No
CRI	>80
Power Factor	>0.9
Beam Angle	140
Warranty	2 years*

Colours

Satin/silver/clear

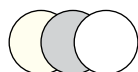

Measurements

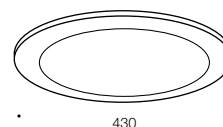
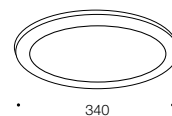

Codes

Astrid OY16-850

Astrid OY22-850

Product Approvals



Astrid

Oak Oyster



Specifications

Type	Oyster
Light Source	LED
Lumen	1200/1700
Colour Temp	5000k
Wattage	16w/22w
Dimmable	No
CRI	>80
Power Factor	>0.9
Beam Angle	140
Warranty	2 years*

Colours

Satin/oak/clear



Measurements

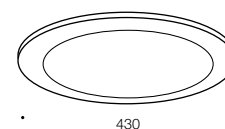
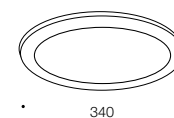

Codes

Astrid OY16-OAK

Astrid OY22-OAK

Product Approvals



Byron

Oyster



Specifications

Type	Oyster
Light Source	LED
Lumen	1100
Colour Temp	4000k
Wattage	16w
Dimmable	No
CRI	>80
Power Factor	>0.9
Beam Angle	140
Warranty	2 years*

Colours

Opaline/chrome

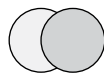

Measurements

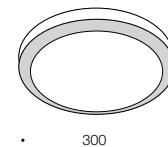

Codes

Byron OY16-840

Product Approvals



Unos

Oyster



Specifications

Type	Oyster
Light Source	LED
Lumen	1900/1950
Colour Temp	3000k/5000k
Wattage	24w
Dimmable	Yes
CRI	>80
Power Factor	>0.9
Beam Angle	140
Warranty	2 years*

Colours

White



Codes

Unos OYR-WH.830

Unos OYR-WH.850

Unos OYS-WH.830

Unos OYS-WH.850

Measurements

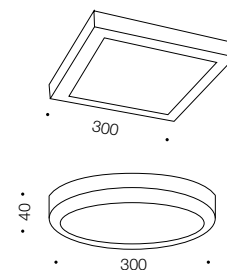

Product Approvals



Jet

Batten



Specifications

Type	Batten
Light Source	LED
Lumen	1800/3900
Colour Temp	5000k
Wattage	18w/40w
Dimmable	No
CRI	>80
Power Factor	>0.9
Beam Angle	140
Warranty	3 years*

Colours

Aluminium/white

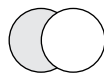

Codes

Jet 18.060AL-850

Jet 18.060WH-850

Jet 40.120AL-850

Jet 40.120WH-850

Measurements

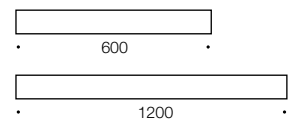

Light Distribution



Product Approvals



Global

Batten



Specifications

Type	Batten
Light Source	LED
Lumen	5000
Colour Temp	5000k
Wattage	45
Dimmable	No
CRI	>80
Power Factor	>0.92
Beam Angle	140
Warranty	3 year*

Colours

White



Measurements

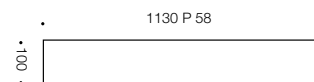

Codes

Global 45.113-850

Product Approvals



Shelta

Batten



Specifications

Type	Batten
Light Source	LED
Lumen	3300
Colour Temp	4000k
Wattage	2x18w T8
Dimmable	No
CRI	>80
Power Factor	>0.9
Beam Angle	140
Warranty	2 years*

Colours

Clear



Measurements

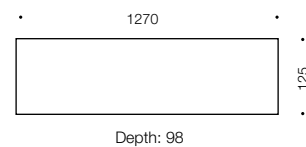

Codes

Shelta 218L.PR-4

Product Approvals



Aero

Batten



Specifications

Type	Batten
Light Source	LED
Lumen	1650
Colour Temp	4000k
Wattage	18w
Dimmable	No
CRI	>80
Power Factor	>0.9
Beam Angle	140
Warranty	2 year*

Colours

Silver



Measurements

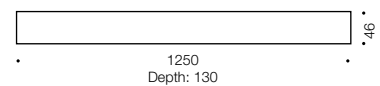

Codes

Aero 118L-SL-4

Product Approvals



Master

Batten



Specifications

Type	Batten
Light Source	LED
Lumen	1500/3000
Colour Temp	5000k
Wattage	16w/32w
Dimmable	No
CRI	>80
Power Factor	>0.9
Beam Angle	140
Warranty	3 years*

Colours

White



Measurements

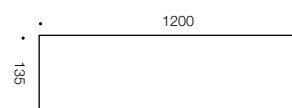
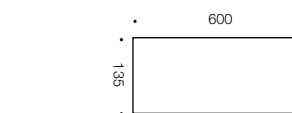

Codes

Master 16-850

Master 32-850

Product Approvals



Marina

Batten



Specifications

Type	Batten
Light Source	LED
Lumen	1600/3250
Colour Temp	5000k
Wattage	16w/32w
Dimmable	No
CRI	>80
Power Factor	>0.9
Beam Angle	140
Warranty	3 years*

Colours

White



Measurements

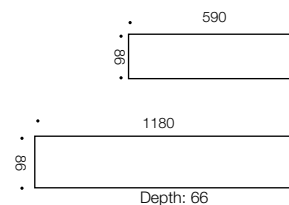

Codes

Marina 16-850

Marina 36-850

Product Approvals



Blade

Batten



Specifications

Type	Batten
Light Source	LED
Lumen	3050/3200
Colour Temp	3000/5000k
Wattage	36w
Dimmable	No
CRI	>80
Power Factor	>0.9
Beam Angle	140
Warranty	2 years*

Colours

White



Measurements

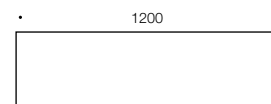

Codes

Blade 36-830

Blade 36-850

Product Approvals



Spotlights



Kuran

Spotlights



Specifications

Type	Spotlight
Light Source	LED
Lumen	350 per unit
Colour Temp	4000k
Wattage	4w per head
Dimmable	No
CRI	>80
Power Factor	>0.9
Beam Angle	120
Warranty	2 year*

Colours

Oak/nickel



Codes

Kuran 1R-OAK

Kuran 2B-OAK

Kuran 3B-OAK

Kuran 4B-OAK

Measurements

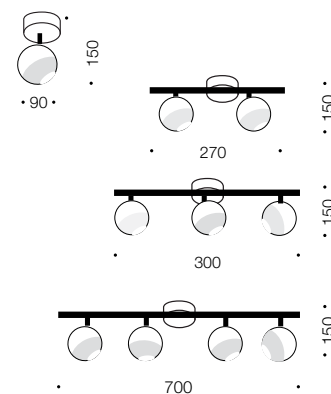

Product Approvals



Burton

Spotlights



Specifications

Type	Spotlights
Light Source	LED GU10
Lumen	500 per unit
Colour Temp	3000k
Wattage	6w per head
Dimmable	No
CRI	>80
Power Factor	>0.9
Beam Angle	140
Warranty	2 year*

Colours

Chrome/white



Codes

Burton SP1-WH

Burton SP2B-WH

Burton SP3B-WH

Burton SP3R-WH

Burton SP4B-WH

Measurements

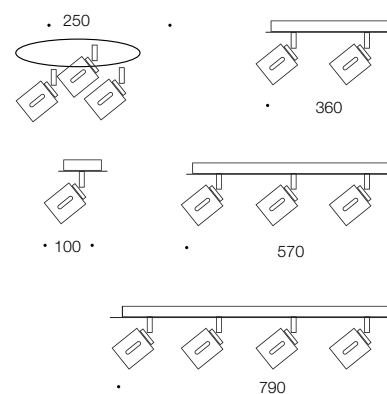

Product Approvals



Kumi

Spotlights



Specifications

Type	Spotlights
Light Source	LED GU10
Lumen	480 per unit
Colour Temp	4000k
Wattage	6w per head
Dimmable	No
CRI	>80
Power Factor	>0.9
Beam Angle	>140
Warranty	2 year*

Colours

Nickel



Codes

Kumi SP1-NK

Kumi SP2-NK

Kumi SP3-NK

Kumi SP4-NK

Measurements

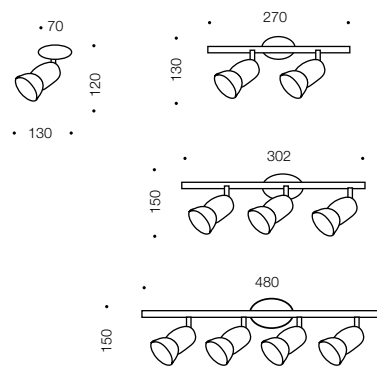

Product Approvals



Tolosa

Spotlights



Specifications

Type	Spotlights
Light Source	COB GU10
Lumen	500 per unit
Colour Temp	3000K
Wattage	6w per head
Dimmable	No
CRI	>80
Power Factor	>0.9
Beam Angle	140
Warranty	2 year*

Colours

White/chrome



Codes

Tolosa SP1-CH	Tolosa SP1-WH
Tolosa SP2B-CH	Tolosa SP2B-WH
Tolosa SP3B-CH	Tolosa SP3B-WH
Tolosa SP3R-CH	Tolosa SP3R-WH
Tolosa SP4B-CH	Tolosa SP4B-WH

Measurements

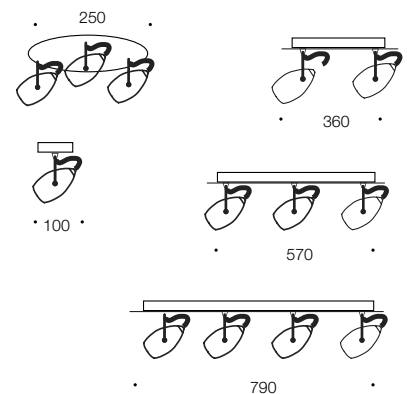

Product Approvals



Arden

Spotlights



Specifications

Type	Spotlight
Light Source	11w E14 max
Globe	Included
Warranty	1 year*

Colours

Nickel/chrome & mirror glass



Measurements

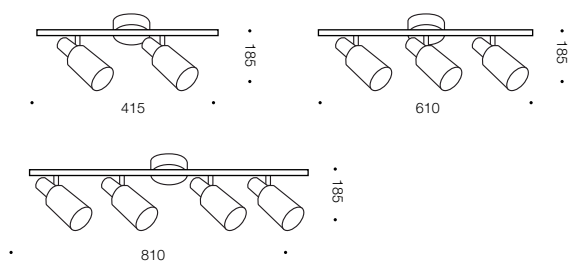

Codes

Arden SP2-NK/CH

Arden SP3-NK/CH

Arden SP4-NK/CH

Product Approvals

IP20



Status

Spotlights



Specifications

Type	Spotlights
Light Source	LED GU10
Lumen	480 per unit
Colour Temp	4000k
Wattage	3 x 6w
Dimmable	No
CRI	>80
Power Factor	>0.9
Beam Angle	140
Warranty	2 year*

Colours

Nickel/chrome glass

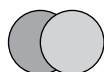

Measurements

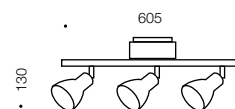

Codes

Status SP3B-NKCH

Product Approvals



Alberg

Spotlights



Specifications

Type	Spotlight
Light Source	11w E14max
Globe	Included
Warranty	1 year*

Colours

Nickel/chrome & frost glass



Measurements

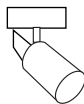

• 140 •

Codes

Alberg SP1-NK

Product Approvals



Downlight 

Retro-fit

MDL-16 Module



- The module 16 with twist on lamp system
- True halogen replacement lamp
- Twist lock onto the latest MDL downlights
- MDL 16 dimmable with all common rotary style dimmers

Available in warm white (3000K) or cool white (5000K)



403 - white



501 - white



503 - white



601 - nickel



601 - white



601 - white/black



603 - nickel



603 - white



603 - white/black



611 - black



611 - white



703 - white



801 - white



801 - nickel



901

MDL-16

Module



Specifications

Type	Downlight
Light Source	LED Cob
Lumen	880
Colour Temp	3000k/5000k
Wattage	12w
Dimmable	Yes
CRI	>92/>80
Power Factor	>0.9
Beam Angle	40
Warranty	5 years*

Colours

White



Codes

Module 16D - 930G2

Module 16D - 850

Measurements

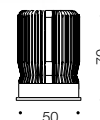

Light Distribution



Product Approvals



MDL 403

Downlight



Specifications

Type	Downlight
Light Source	LED COB
Lumen	880
Colour Temp	3000k/5000k
Wattage	12w
Dimmable	Yes
CRI	>80
Power Factor	>0.9
Beam Angle	40
Warranty	5 years*

Colours

White



Codes

MDL 403- WH

+ MDL-16D-930G2
or
MDL-16D-850

Measurements

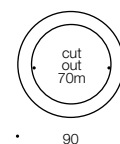

Light Distribution



Product Approvals



MDL 501

Downlight



Specifications

Type	Downlight
Light Source	LED COB
Lumen	880
Colour Temp	3000k/5000k
Wattage	12w
Dimmable	Yes
CRI	>92/>80
Power Factor	>0.9
Beam Angle	40
Warranty	5 years*

Colours

White



Codes

MDL 501 - WH

+ MDL-16D-930G2
or
MDL-16D-850

Measurements

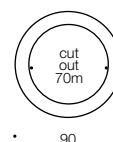

Light Distribution



Product Approvals



MDL 503

Downlight



Specifications

Type	Downlight
Light Source	LED COB
Lumen	880
Colour Temp	3000k/5000k
Wattage	12w
Dimmable	Yes
CRI	>92/>80
Power Factor	>0.9
Beam Angle	40
Warranty	5 years*

Colours

White



Codes

MDL 503 - WH

+ MDL-16D-930G2
or
MDL-16D-850

Measurements

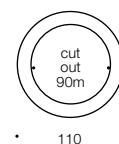

Light Distribution



Product Approvals



MDL 601

Downlight



Specifications

Type	Downlight
Light Source	LED COB
Lumen	880
Colour Temp	3000k/5000k
Wattage	12w
Dimmable	Yes
CRI	>92/>80
Power Factor	>0.9
Beam Angle	40
Warranty	5 years*

Colours

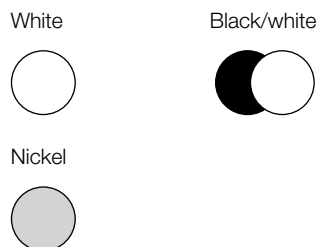

Codes

MDL-601-NK

MDL- 601-WH

MDL- 601-WHBK

+ MDL-16D-930G2 or
MDL-16D-850

Measurements

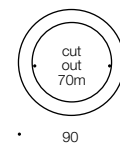

Light Distribution



Product Approvals



MDL 603

Downlight



Specifications

Type	Downlight
Light Source	LED COB
Lumen	880
Colour Temp	3000K/5000K
Wattage	12w
Dimmable	Yes
CRI	>92/>80
Power Factor	>0.9
Beam Angle	40
Warranty	5 years*

Colours

White



Codes

MDL 603 - NK

MDL 603 - WH

MDL 603 - WHBK

Measurements

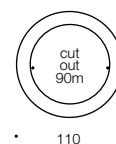

Light Distribution

Product Approvals



MDL 611

Downlight



Specifications

Type	Downlight
Light Source	LED COB
Lumen	880
Colour Temp	3000K/5000K
Wattage	12w
Dimmable	Yes
CRI	>92/>80
Power Factor	>0.9
Beam Angle	40
Warranty	5 years*

Colours

Black/white



Codes

MDL- 611-WH

MDL-611-BK

+ MDL-16D-930G2 or
MDL-16D-850

Measurements

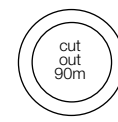

Light Distribution



Product Approvals



MDL 703

Downlight



Specifications

Type	Downlight
Light Source	LED COB
Lumen	880
Colour Temp	3000k/5000k
Wattage	12w
Dimmable	Yes
CRI	>92/>80
Power Factor	>0.9
Beam Angle	40
Warranty	5 years*

Colours

White



Codes

MDL-703-WH

+ MDL-16D-930G2
or
MDL-16D-850

Measurements

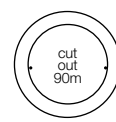

Light Distribution



Product Approvals



MDL 801

Downlight



Specifications

Type	Downlight
Light Source	LED Cob
Lumen	880
Colour Temp	3000k/5000k
Wattage	12w
Dimmable	Yes
CRI	>92/>80
Power Factor	>0.9
Beam Angle	40
Warranty	5 years*

Colours

Nickel/white

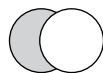

Codes

MDL-801-WH

MDL-801-NK

+ MDL-16D-930G2
or
MDL-16D-850

Measurements

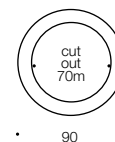

Light Distribution



Product Approvals



MDL 901

Downlight



Specifications

Type	Downlight
Light Source	LED COB
Lumen	800/840
Colour Temp	3000k/5000k
Wattage	12w
Dimmable	Yes
CRI	>80
Power Factor	>0.9
Beam Angle	40
Warranty	5 years*

Colours

Black/white



Codes

MDL-901-WHBK

+ MDL 16D-830G2
or
MDL-16D-850

Measurements



Darker lighter includes
9 + 36mm gasket

88

Product Approvals



Opus 105

Downlight



Specifications

Type	Downlight
Light Source	LED Cob
Lumen	600/630
Colour Temp	3000k/5000k
Wattage	10w
Dimmable	No
CRI	>80
Power Factor	>0.9
Beam Angle	40
Warranty	2 years*

Colours

White



Codes

OPUS 105.WH-830

OPUS 105.WH-850

Measurements

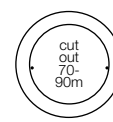

• 105 •

Product Approvals



Cobpro

Downlight



Specifications

Type	Downlight
Light Source	LED COB
Lumen	850/880
Colour Temp	3000K/5000K
Wattage	10w
Dimmable	Yes
CRI	>82
Power Factor	>0.9
Beam Angle	38
Warranty	3 years*

Colours

White



Codes

CobPro1-WH-830

CobPro1-WH-850

Measurements



Cut out 70-90mm

Light Distribution



Product Approvals

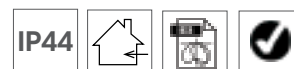

Panel

Downlight



Specifications

Type	Downlight
Light Source	LED
Lumen	1050/1100
Colour Temp	3000k/5000k
Wattage	13w
Dimmable	No
CRI	>80
Power Factor	>0.9
Beam Angle	110
Warranty	3 years*

Colours

Nickel/white



Codes

Panel RD17-NK830

Panel RD17-NK850

Panel RD17-WH830

Panel RD17-WH850

Measurements

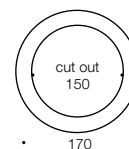

Product Approvals



Rondo

Downlight



Specifications

Type	Downlight
Light Source	LED
Lumen	900/950
Colour Temp	3000k/5000k
Wattage	10w
Dimmable	Yes
CRI	>80
Power Factor	>0.9
Beam Angle	108
Warranty	5 years*

Colours

White



Codes

Rondo 110-WH-830G2

Rondo 110-WH-850G2

Measurements



Light Distribution



Product Approvals



Revo

Downlight



Specifications

Type	Downlight
Light Source	SMD
Lumen	650/720
Colour Temp	3000k/5000k
Wattage	10w
Dimmable	Optional
CRI	> 82
Power Factor	> 0.92
Beam Angle	90
Warranty	3 years*

Colours

White



Codes

Revo DL110-830

Revo DL110-830D

Revo DL110-850

Revo DL110-850D

Measurements

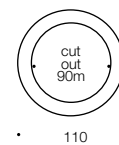

110

Product Approvals



Flat 90

Downlight



**MORE LUMEN
LESS POWER**

Specifications

Type	Downlight
Light Source	LED
Lumen	750/790
Colour Temp	3000k/5000k
Wattage	8w
Dimmable	Yes
CRI	>80
Power Factor	>0.9
Beam Angle	90
Warranty	5 years*

Colours

Nickel/white

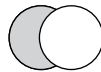

Codes

Flat 090-NK-830/850G2

Flat 090-WH-830/850G2

Measurements

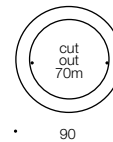

Light Distribution



Product Approvals



Flat 100

Downlight



**MORE LUMEN
LESS POWER**

Specifications

Type	Downlight
Light Source	LED Cob
Lumen	900/950
Colour Temp	3000k/5000k
Wattage	10w
Dimmable	Yes
CRI	> 80
Power Factor	> 0.9
Beam Angle	108
Warranty	5 years*

Colours

Nickel/white

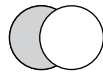

Codes

Flat 100-NK-830/850G2

Flat 100-WH-830/850G2

Measurements

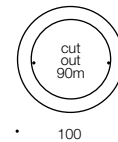

Light Distribution



Product Approvals



Tornado G2 30

Downlight



Specifications

Type	Downlight
Light Source	LED
Lumen 30w	2950/3140
Colour Temp	3000k/5000k
Wattage	30w
Dimmable	No
CRI	>80
Power Factor	>0.9
Beam Angle	140
Warranty	5 years*

Colours

White



Codes

Tornado G2.30-83

Tornado G2.30-85

Measurements

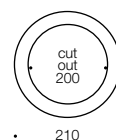

Light Distribution



Product Approvals



Tornado G2 40

Downlight



**MORE LUMEN
LESS POWER**

Specifications

Type	Downlight
Light Source	LED
Lumen 40w	3950/4120
Colour Temp	3000k/5000k
Wattage	40w
Dimmable	No
CRI	>80
Power Factor	>0.9
Beam Angle	140
Warranty	5 years*

Colours

White



Codes

Tornado G2.40-83

Tornado G2.40-85

Measurements

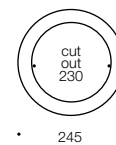

Light Distribution



Product Approvals



Tornado 16

Downlight



Specifications

Type	Downlight
Light Source	LED
Lumen 16w	1020/1220
Colour Temp	3000k/5000k
Wattage	16w
Dimmable	Yes
CRI	>80
Power Factor	>0.9
Beam Angle	140
Warranty	5 years*

Colours

White



Codes

Tornado R16-WH83

Tornado R16-WH85

Measurements

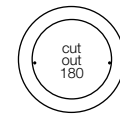

Light Distribution



Product Approvals



Tornado 20

Downlight



Specifications

Type	Downlight
Light Source	LED
Lumen 20w	2100/2300
Colour Temp	3000k/5000k
Wattage	20w
Dimmable	Yes
CRI	>80
Power Factor	>0.9
Beam Angle	140
Warranty	5 years*

Colours

White



Codes

Tornado R20-WH83

Tornado R20-WH85

Measurements

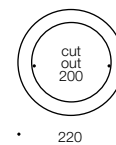

Light Distribution



Product Approvals



Rotary 12

Downlight



Specifications

Type	Downlight
Light Source	LED
Lumen	670
Colour Temp	5000k
Wattage	12w
Dimmable	Yes
CRI	>80
Power Factor	>0.9
Beam Angle	80
Warranty	5 years*

Colours

Nickel/white

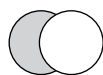

Codes

Rotary RD/SQ12-NK85

Rotary RD/SQ12-WH85

Measurements

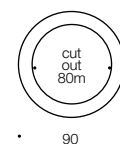

Light Distribution



Product Approvals



Rotary 15

Downlight



Specifications

Type	Downlight
Light Source	LED
Lumen	930
Colour Temp	5000k
Wattage	15w
Dimmable	Yes
CRI	>80
Power Factor	>0.9
Beam Angle	80
Warranty	5 years*

Colours

Nickel/white

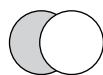

Codes

Rotary RD/SQ15-NK85

Rotary RD/SQ15-WH85

Measurements

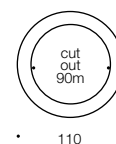

Light Distribution



Product Approvals



Nara

Downlight



Specifications

Type	CTC
Light Source	LED
Lumen	1350/1400
Colour Temp	3000k/5000k
Wattage	18w
Dimmable	Yes
CRI	>80
Power Factor	>0.9
Beam Angle	>120
Warranty	2 year*

Colours

White



Measurements

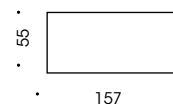

Codes

Nara CTC-WH.830

Nara CTC-WH.850

Product Approvals



Daro

Downlight



Specifications

Type	Downlight
Light Source	LED
Lumen	800
Colour Temp	4000k
Wattage	12w
Dimmable	No
CRI	>80
Power Factor	>0.9
Beam Angle	38
Warranty	2 years*

Colours

White



Measurements

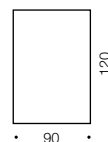

Codes

na DL.CTC-WH84

Product Approvals



301/303 GU10

Downlight – guard



Specifications

Type	Downlight
Warranty	1 year*

Measurements

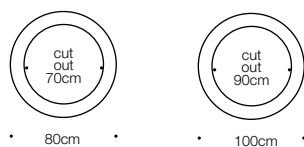

Globes



Colours

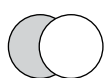

Codes

301 Guard LED 6w Kit-WH

301 Guard LED 6w Kit-NK

301 Guard LED 8w Kit-WH

301 Guard LED 8w Kit-NK

303 Guard LED 6w Kit-NK

303 Guard LED 8w Kit-NK

Product Approvals



301/303 GU10

Downlight



Specifications

Type	Downlight
Light Source	9w LED GU10 max
Globe	Not included
Warranty	1 year*

Colours

Nickel/white

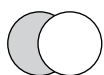

Measurements

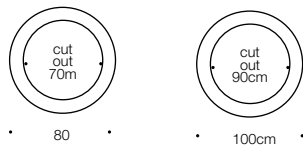

Codes

301 LED 6w Kit-WH

301 LED 6w Kit-NK

301 LED 8w Kit-WH

301 LED 8w Kit-NK

303 LED 6w Kit-NK

303 LED 8w Kit-NK

Globes



6w COB



8W COB

Product Approvals



Taso

Downlight



Specifications

Type	Downlight
Light Source	12w GU10 max
Globe	Not included
Warranty	1 year*

Measurements

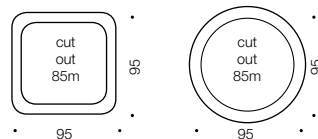

Globes



6w COB



8w COB

Colours

Silver/white

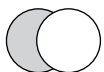

Codes

Taso DL.SQ-SL

Taso DL.SQ-WH

Taso DL.RD-SL

Product Approvals



Alpha GU10

Downlight



Specifications

Type	Downlight
Light Source	2x9w GU10 max
Globe	Not included
Warranty	1 year*

Measurements

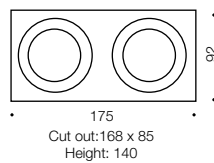

Globes



6w COB



8w COB

Colours

Aluminium



Codes

ALPHA DL2RE-AL

Product Approvals



LED Stripe

3000k/5000k



Specifications

Type	LED Stripe
Light Source	LED
Lumen	1000/1100
Colour Temp	3000k/5000k
Wattage	20w/22w SMD
Dimmable	No
CRI	>80
Power Factor	>0.9
Beam Angle	140
Warranty	2 years*

Colours

White



Codes

LED.Stripe-5M-3K

LED.Stripe-5M-5K

Measurements

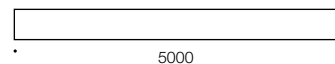

Product Approvals



LED

RGB Kit



Specifications

Type	Tape Kit
Light Source	LED
Lumen	1000
Colour Temp	RGB
Wattage	20w SMD
Dimmable	No
CRI	>80
Power Factor	>0.9
Beam Angle	140
Warranty	2 years*

Colours

Red/green/blue



Codes

LED.Stripe-5-RGB

Measurements

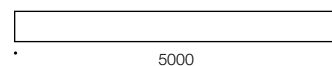

Product Approvals



Cabinet Round

Downlight



Specifications

Type	Downlight
Light Source	20w 12v
Globe	Included
Warranty	1 year*

Colours

Nickel



Measurements

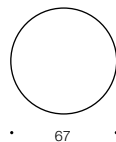

Option:
Transformer required
LTR 60va 12v Dimmable



Codes

Cabinet DL.RD-NK

Product Approvals



Exterior





Elton

Exterior Wall Lamp



Specifications

Type	Exterior
Light Source	LED GU10
Lumen	640
Colour Temp	4000k
Wattage	4w
Dimmable	No
CRI	>80
Power Factor	>0.9
Beam Angle	140
Warranty	2 year*

Colours

Aluminium/black

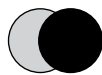

Codes

Elton EX2-AL

Elton EX2-BK

Measurements

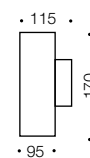

Product Approvals



Move

Exterior Wall Lamp



Specifications

Type	Exterior
Light Source	LED GU10
Lumen	480
Colour Temp	5000k
Wattage	6w
Dimmable	No
CRI	>80
Power Factor	>0.9
Beam Angle	140
Warranty	2 year

Colours

Black/silver



Codes

Move EX1-BK

Move EX1-SL

Measurements

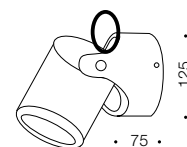

Product Approvals



Turn

Exterior Wall Lamp



Specifications

Type	Exterior
Light Source	LED GU10
Lumen	480
Colour Temp	5000k
Wattage	6w
Dimmable	No
CRI	>80
Power Factor	>0.9
Beam Angle	140
Warranty	2 year*

Colours

Black/silver

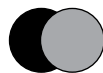

Measurements

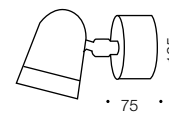

Codes

Turn EX1-BK

Turn EX1-SL

Product Approvals



Alwin

Exterior Wall Lamp



Specifications

Type	Exterior
Light Source	GU10PAR6
Lumen	480
Colour Temp	4000k
Wattage	6w
Dimmable	No
CRI	>80
Power Factor	>0.9
Beam Angle	140
Warranty	2 year

Colours

Black/silver

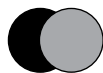

Codes

Alwin EX1-BK

Alwin EX1-SL

Measurements

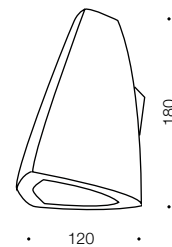

Product Approvals



Kyo

Exterior Wall Lamp



Specifications

Type	Exterior
Light Source	LED
Lumen	480
Colour Temp	4000k
Wattage	2 x 3w
Dimmable	No
CRI	>80
Power Factor	>0.9
Beam Angle	140
Warranty	2 year

Colours

Black/silver



Codes

Kyo EX2-BK

Kyo EX2-SL

Measurements

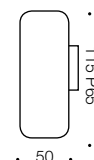

Product Approvals



Davis

Exterior Wall Lamp



Specifications

Type	Exterior
Light Source	35w GU10 240v
Globe	Included
Warranty	1 year*

Measurements

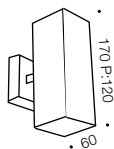

Colours

Stainless steel/frost

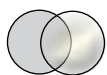

Codes

Davis EX.W-SS

Davis LEDEX.W-SS

Product Approvals



Akard

Exterior Wall Lamp



Specifications

Type	Exterior
Light Source	35w GU10 240v
Globe	Included
Warranty	1 year*

Colours

Stainless steel/Frost

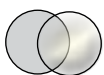

Measurements

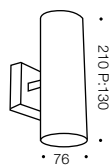

Codes

Akard EX.W-SS

Akard LEDEX.W-SS

Product Approvals



Rebus

Exterior Wall Lamp



Specifications

Type	Exterior
Light Source	LED GU10
Lumen	120
Colour Temp	3000k
Wattage	1.5w SMD
Dimmable	No
CRI	>80
Power Factor	>0.9
Beam Angle	140
Warranty	2 year*

Colours

Black/frost

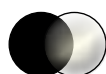

SS 304/frost

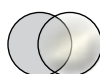

Measurements

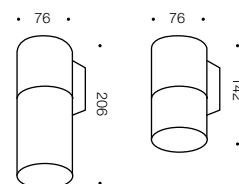

240
volt

Globe included
1.5w SMD GU10 240v

Codes

Rebus EX1-SS

Rebus EX1-BK

Rebus EX2-SS

Product Approvals



Morley

Exterior Wall Lamp



Specifications

Type	Exterior
Light Source	3 x 14w E27max
Globe	Not included
Warranty	1 year*

Colours

Silver/opal

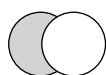

Measurements

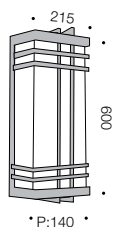

Codes

Morley EX3-SL

Product Approvals



Charles

Exterior Wall Lamp



Specifications

Type	Exterior
Light Source	3x14w E27max
Globe	Not included
Warranty	1 year*

Measurements

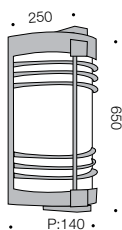

Colours

Black/silver



Codes

Charles EX3-BK

Charles EX3-SL

Product Approvals



Ethan

Exterior Wall Lamp



Specifications

Type	Exterior
Light Source	14w E27max
Globe	Not included
Warranty	1 year*

Measurements

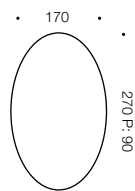

Colours

Black



Codes

Ethan EX.W-BK

Product Approvals





Harbor

Exterior Post



Specifications

Type	Exterior Post
Light Source	E27 40w max
Globe	Not included
Warranty	1 year*

Measurements

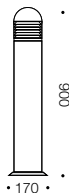

Colours

Black/silver

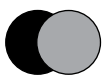

Codes

Harbor EX.PTL-BK

Harbor EX.PTL-SL

Product Approvals



Benton

Exterior Bollard



Specifications

Type	Bollard
Light Source	GU10
Globe	Not included
Warranty	1 year*

Colours

Stainless Steel



Measurements



Codes

Benton EX.P-SS

Product Approvals



Albion

Exterior



Specifications

Type	Exterior
Light Source	LED
Lumen	480
Colour Temp	4000k
Wattage	6w
Dimmable	No
CRI	>80
Power Factor	>0.9
Beam Angle	140
Warranty	2 year*

Colours

Black/silver



Codes

ALBION EX.C-BK

ALBION EX.C-SL

ALBION EX.P-BK

ALBION EX.P-SL

ALBION EX.W-BK

ALBION EX.W-SL

Measurements

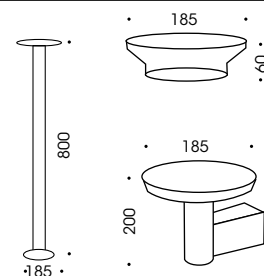

Product Approvals



Rebus

Exterior Spike



Specifications

Type	Spike
Light Source	1.6w SMD-MR16 12v
Globe	Included
Warranty	1 year*

Colours

Stainless Steel



Measurements

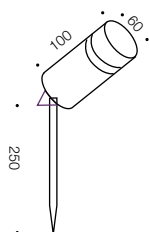

Option:
Transformer required
TR 36va with 15m SPT-2W cable

12
VOLT

^Globe included
1.6w SMD MR16 12v

Codes

Rebus EX60SP-SS

Product Approvals

IP65



Kotos

Exterior Post



Specifications

Type	Post
Light Source	0.8w SMD-MR11 12v
Globe	Included
Warranty	1 year*

Colours

Stainless Steel



Measurements



12
VOLT



*Globe included
0.8w SMD MR11 12v

Option:
Transformer required
TR 36va with 15m SPT-2W cable



Codes

Kotos EX47PT-SS

Product Approvals



Brent

Exterior Oyster



Specifications

Type	Exterior
Light Source	14w E27 max
Globe	Not included
Warranty	1 year*

Colours

Silver/opal diffuser

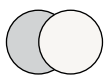

Measurements

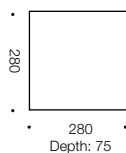

Codes

Brent EX.OY-SL

Product Approvals



Domain

Exterior Oyster



Specifications

Type	Exterior
Light Source	14w E27 max
Globe	Not included
Warranty	1 year*

Measurements

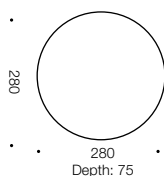

Colours

Satin/opal diffuser



Codes

Domain EX.OY-SL

Product Approvals



Tora

Exterior Wall Lamp



Specifications

Type	Exterior
Light Source	SMD
Lumen	480
Colour Temp	4000k
Wattage	6w
Dimmable	No
CRI	>80
Power Factor	>0.9
Beam Angle	140
Warranty	2 year*

Colours

Black/silver

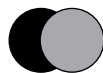

Codes

Tora EX-BK

Tora EX-SL

Measurements

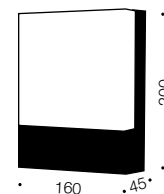

Product Approvals



Prima

Exterior Wall Lamp



Specifications

Type	Exterior
Light Source	LED
Lumen	90/110/60
Colour Temp	4000k
Wattage	1.5w/2w/1w
Dimmable	No
CRI	>80
Power Factor	>0.9
Beam Angle	140
Warranty	2 year

Colours

Black/silver



Codes

Prima EX.RD-BK

Prima EX.RD-SL

Prima EX.RE-BK

Prima EX.RE-SL

Prima EX.SQ-BK

Prima EX.SQ-SL

Measurements

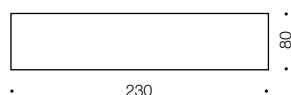
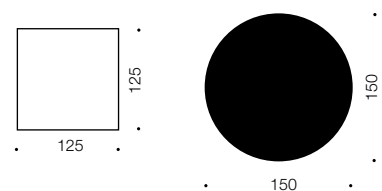

Product Approvals





Sensor

Exterior Wall Lamp



Specifications

Type	Exterior
Light Source	1000w 18°
Globe	Not included
Warranty	1 year*

Measurements

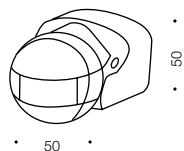

Colours

Black/white



Codes

Sensor PIR 180-BK

Sensor PIR 180-WH

Product Approvals



Austin

Flood Light



Specifications

Type	Exterior
Light Source	LED
Lumen	820
Colour Temp	5000k
Wattage	10w
Dimmable	No
CRI	>80
Power Factor	>0.9
Beam Angle	140
Warranty	2 year*

Colours

Black/silver

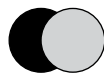

Codes

Austin EX.10w-BK

Austin EX.10w-SL

Measurements

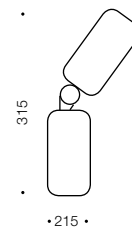

Product Approvals



Atrium

Exterior Wall Lamp



Specifications

Type	Exterior
Light Source	LED
Lumen	420
Colour Temp	4000k
Wattage	6w
Dimmable	No
CRI	>80
Power Factor	>0.9
Beam Angle	140
Warranty	2 year*

Colours

Black/silver

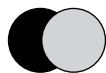

Codes

Atrium EX.W-BK

Atrium EX.W-SL

Measurements

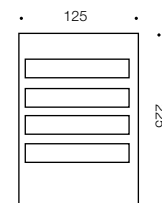

Product Approvals



Hurst

Exterior Wall Lamp



Specifications

Type	Exterior
Light Source	LED
Lumen	480
Colour Temp	4000K
Wattage	6w
Dimmable	No
CRI	>80
Power Factor	>0.9
Beam Angle	140
Warranty	2 year

Colours

Stainless Steel



Codes

Hurst EX.W-SS

Measurements

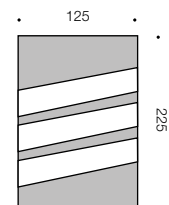

Product Approvals



Kerry

Exterior Wall Lamp



Specifications

Type	Exterior
Light Source	14w E27max
Globe	Not included
Warranty	1 year*

Colours

Stainless Steel/frost

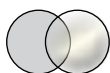

Measurements

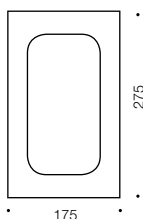

Codes

Kerry EX.W-SSFR

Product Approvals



Illume

Exterior Spot



Specifications

Type	Exterior
Light Source	Intergrated LED
Lumen	1600
Colour Temp	5000k
Wattage	10w
Dimmable	No
CRI	>80
Power Factor	>0.9
Beam Angle	140
Warranty	2 year

Colours

Black/silver



Codes

Illume EX2-BK

Illume EX2-SL

Illume EX2S-BK

Illume EX2S-SL

Measurements

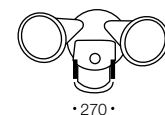
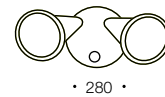

Product Approvals



Titan

Exterior Spot



Specifications

Type	Exterior
Light Source	LED GU10 cob
Lumen	450 per head
Colour Temp	3000k
Wattage	6w per unit
Dimmable	No
CRI	>80
Power Factor	>0.9
Beam Angle	140
Warranty	2 year

Colours

Beige/black/nickel

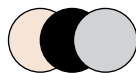

Codes

Titan EX.1S-BE Titan EX.1S-BK

Titan EX.1S-NK

Titan EX.1-BE Titan EX.1-BK

Titan EX.1-NK

Titan EX.2S-BE Titan EX.2S-BK

Titan EX.2S-NK

Titan EX.2-BE Titan EX.2-BK

Titan EX.2-NK

Measurements

Back plate: 125

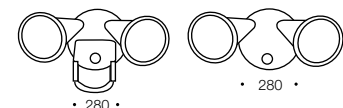
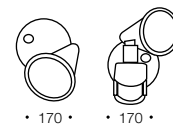

Product Approvals



Magneto

Exterior Spot



Specifications

Type	Exterior
Light Source	100w G9
Globe	Included
Warranty	1 year*

Colours

Black



Measurements

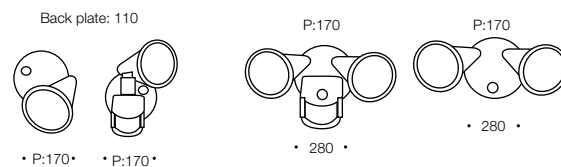

Codes

Magneto 1-BK

Magneto 1S-BK

Magneto 2-BK

Magneto 2S-BK

Product Approvals



Flip

Wall Lamp

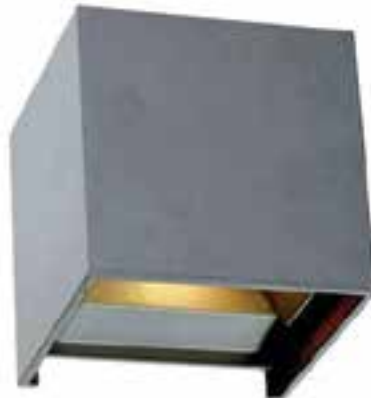

Specifications

Type	Exterior
Light Source	LED
Lumen	400
Colour Temp	4000k
Wattage	5w
Dimmable	No
CRI	>80
Power Factor	>0.9
Beam Angle	140
Warranty	2 year*

Colours

Black/silver/white

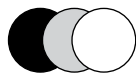

Codes

Flip WB-BK

Flip WB-SL

Flip WB-WH

Measurements

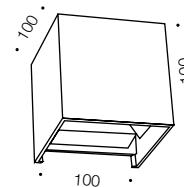

Product Approvals





Deck Lights

Remote



Specifications

Type	Deck light
Light Source	LED
Lumen	40 per unit
Colour Temp	RGB
Wattage	0.3w per unit
Dimmable	No
CRI	>80
Power Factor	>0.9
Beam Angle	140
Warranty	2 year*

Colours

Stainless steel



Measurements

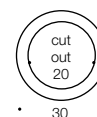

Codes

Deck 30*10-RGB

Deck 30*6-RGB

Product Approvals



Deck Lights



Specifications

Type	Deck light
Light Source	LED
Lumen	90 per unit
Colour Temp	4000K
Wattage	1.0w per unit
Dimmable	No
CRI	>80
Power Factor	>0.9
Beam Angle	140
Warranty	2 year*

Colours

Stainless steel



Measurements

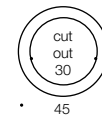

Codes

Deck 45*10-840

Deck 45*6-840

Product Approvals

IP67



Vesta

Ground Light



Specifications

Type	Ground lights
Light Source	0.8w SMD-MR11 12v 1.6w SMD-MR16 12v
Globe	Included
Warranty	1 year*

Colours

Stainless Steel



Measurements

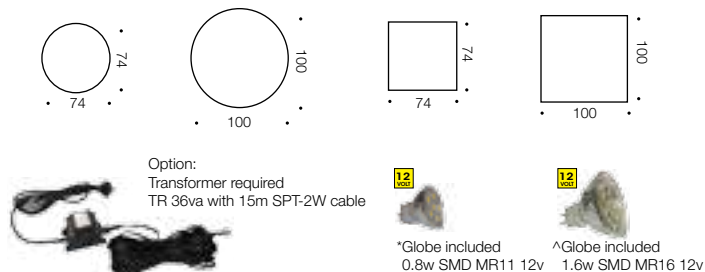

Codes

Vesta EX.07RD-SS

Vesta EX.07SQ-SS

Vesta EX.10RD-SS

Vesta EX.10SQ-SS

Product Approvals

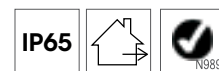

Denali

Exterior Wall Lamp



Specifications

Type	Exterior
Light Source	LED SMD
Lumen	500
Colour Temp	4000k
Wattage	6w
Dimmable	No
CRI	>80
Power Factor	>0.9
Beam Angle	140
Warranty	2 year*

Colours

Black/silver

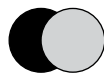

Codes

Denali EX.W-BK

Denali EX.W-SL

Measurements

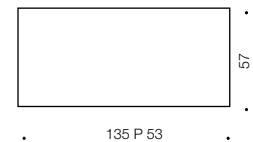

Product Approvals



Bloc

Exterior Wall Lamp

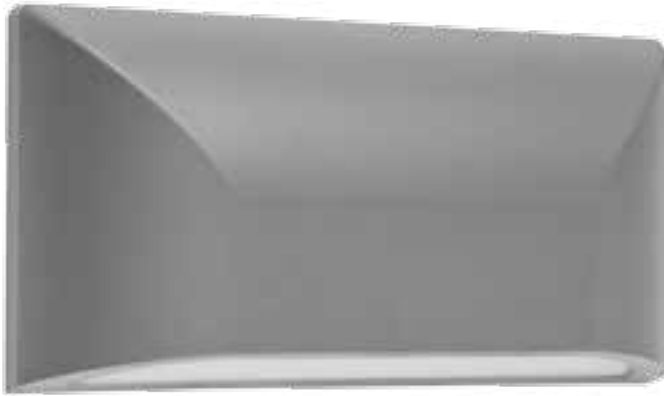

Specifications

Type	Exterior
Light Source	LED
Lumen	400
Colour Temp	4000k
Wattage	5w
Dimmable	No
CRI	>80
Power Factor	>0.90
Beam Angle	140
Warranty	2 year*

Colours

Black/silver



Measurements



Codes

BLOC EX5-BK

BLOC EX5-SL

Product Approvals





Wynn

Bunker



Specifications

Type	Exterior
Light Source	LED
Lumen	600
Colour Temp	4000k
Wattage	6w
Dimmable	No
CRI	>80
Power Factor	>0.9
Beam Angle	140
Warranty	2 year

Colours

Black/silver



Measurements

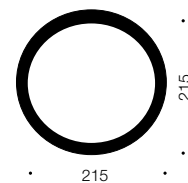

Codes

Wynn EX8-BK

Wynn EX8-SL

Product Approvals



Andra

Bunker



Specifications

Type	Exterior
Light Source	LED
Lumen	600
Colour Temp	4000k
Wattage	8w
Dimmable	No
CRI	>80
Power Factor	>0.9
Beam Angle	140
Warranty	2 year*

Colours

Black/silver



Measurements



Codes

ANDRA EX8-SL

ANDRA EX8-BK

Product Approvals



Eos

Exterior Wall Lamp



Specifications

Type	Exterior
Light Source	6w GU10
Globe	Not included
Warranty	1 year*

Colours

Black/silver

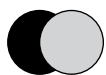

Measurements

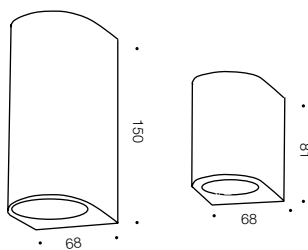

Codes

EOS EX1-BK

EOS EX1-SL

EOS EX2-BK

EOS EX2-SL

Product Approvals



Aron

Exterior Wall Lamp



Specifications

Type	Exterior
Light Source	35w GU10 240v
Globe	Included
Warranty	1 year*

Colours

Stainless steel



Measurements

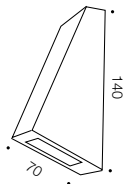

Codes

ARON.EX1-SS

Product Approvals



Endo

Exterior Wall Lamp



Specifications

Type	Exterior
Light Source	60w E27
Globe	Not Included
Warranty	1 year*

Colours

304 Stainless steel



Measurements

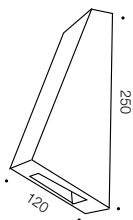

Codes

ENDO.EX1-SS

Product Approvals



Briar

Exterior Wall Lamp

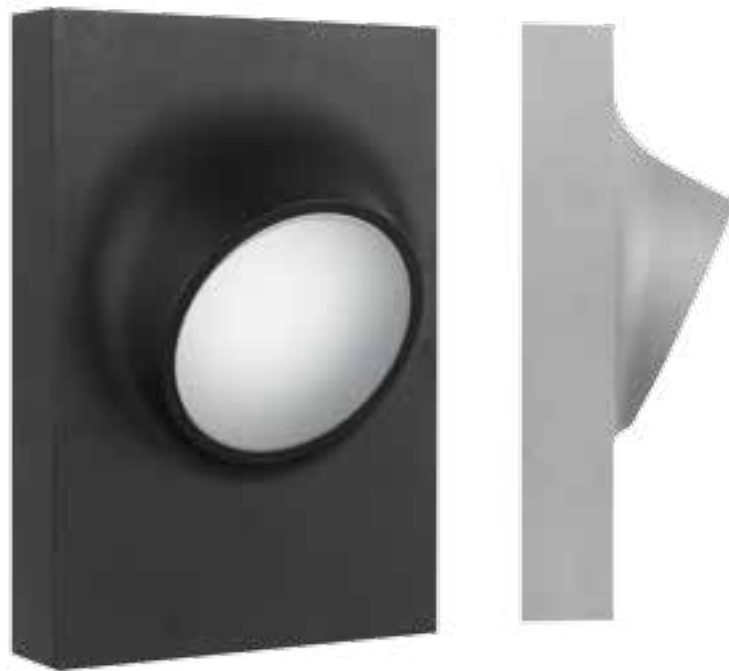

Specifications

Type	Exterior
Light Source	LED
Lumen	280
Colour Temp	5000k
Wattage	3w
Dimmable	No
CRI	>80
Power Factor	>0.9
Beam Angle	140
Warranty	2 year*

Colours

Black/silver



Measurements

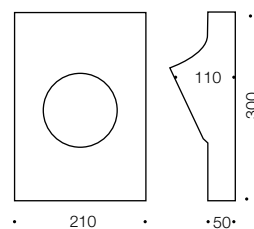

Codes

Briar EX.3W-BK

Briar EX.3W-SL

Product Approvals



Roland

Exterior Wall Lamp



Specifications

Type	Exterior
Light Source	35w GU10
Globe	Included
Warranty	1 year*

Colours

Black/silver with clear glass



Measurements

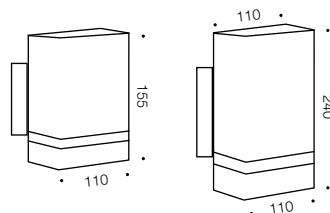

Codes

Roland EX1-BK

Roland EX2-BK

Roland EX2-SL

Product Approvals

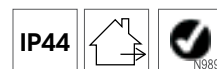

Dixon

Exterior Wall Lamp



Specifications

Type	Exterior
Light Source	35w GU10 240v
Globe	Included
Warranty	1 year*

Colours

Stainless steel with frost glass

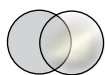

Measurements

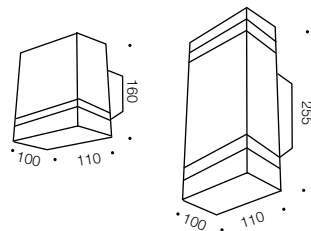

Codes

Dixon EX.1-SS

Dixon EX.2-SS

Product Approvals



Bass

Exterior Wall Lamp



Specifications

Type	Exterior
Light Source	60w E27
Globe	Not included
Warranty	1 year*

Measurements

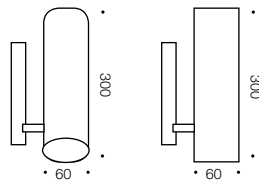

Colours

Stainless steel



Codes

Bass EXR-SS

Bass EXS-SS

Product Approvals

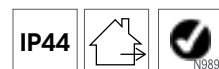

Pelare

Exterior Wall Lamp



Specifications

Type	Exterior
Light Source	7w G9 Fluro
Globe	Included
Warranty	1 year*

Colours

Stainless steel



Measurements

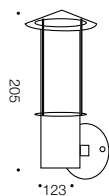

Codes

Pelare EX.WB-SS

Product Approvals



Effect

Exterior Wall Lamp



Specifications

Type	Exteriors
Light Source	7w Fluro G9
Globe	Included
Warranty	1 year*

Colours

Stainless steel



Measurements

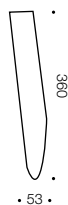

Codes

Effect EX.WB-SS

Product Approvals



Riva

Exterior Wall Lamp



Specifications

Type	Exterior
Light Source	28w GU10
Globe	Included
Warranty	2 year*

Colours

Stainless steel



Measurements

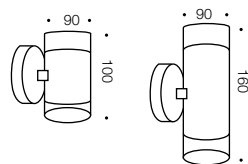

Codes

Riva EX1-SS

Riva EX2-SS

Product Approvals

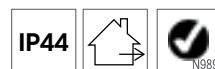

Riva LED

Exterior Wall Lamp



Specifications

Type	Exterior
Light Source	2.25w GU10 LED
Lumen	500 per unit
Colour Temp	3000k
Wattage	2.5w x 2
Dimmable	No
CRI	>80
Power Factor	>0.9
Beam Angle	38°
Warranty	2 year*

Colours

Stainless steel



Codes

Riva EX2LED-SS

Measurements

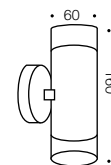

Product Approvals



Conley

Exterior Wall Lamp



Specifications

Type	Exterior
Light Source	2x28w GU10 240v
Globe	Included
Warranty	1 year*

Colours

Black/Stainless steel with frost glass



Measurements

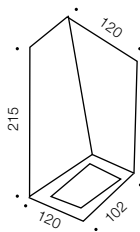

Codes

Conley EX.2-BK

Conley EX.2-SS

Product Approvals



Globes



Pye Globe



Specifications

Type	Globe
Light Source	LED E27
Lumen	1000/1050 1500/1600
Colour Temp	3000k/5000k
Wattage	12w/18w
Dimmable	No
CRI	>80
Power Factor	>0.9
Beam Angle	140
Warranty	2 year*

Colours

Clear



Codes

GL PYE 12.160-83

GL PYE 12.160-85

GL PYE 18.230-83

GL PYE 18.230-85

Measurements

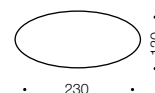
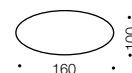

Product Approvals

IP20



LED Filament Globe

Specifications

Type	Globe
Light Source	LED E27
Lumen	360/400 550/600
Colour Temp	3000k/5000k
Wattage	4w/6w
Dimmable	No
CRI	>80
Power Factor	>0.6
Beam Angle	360
Warranty	2 year*



Codes

GL.F.G095.4-AM83

GL.F.G095.4-FR85

GL.F.G125.6-AM83

GL.F.G125.6-AM85

Colours

Amber/Frost

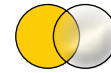

Product Approvals

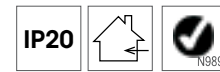

Filament Pilot Globe

Specifications

Type	Globe
Light Source	LED E27
Lumen	360/400
Colour Temp	3000k/5000k
Wattage	4w 240v E27
Dimmable	No
CRI	>80
Power Factor	>0.6
Beam Angle	360
Warranty	2 year*



Codes

GL.F.PILT.4-AM83

GL.F.PILT.4-FR85

Colours

Amber/Frost

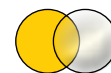

Product Approvals



Filament

Candle Globe

Specifications

Type	Candle
Light Source	LED E14
Lumen	270/300
Colour Temp	3000k/5000k
Wattage	3w
Dimmable	No
CRI	>80
Power Factor	>0.6
Beam Angle	360
Warranty	2 year*



Codes

GL.F.CAND.3-AM83

GL.F.CAND.3-FR85

Colours

Amber/Frost

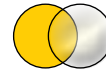

Product Approvals



Fancy Round

Globe

Specifications

Type	Globe
Light Source	LED E14
Lumen	320
Colour Temp	3000k
Wattage	4w
Dimmable	No
CRI	>80
Power Factor	>0.6
Beam Angle	360
Warranty	2 year*



Codes

GL FR4LEDE14-830

Colours/Measurements

Clear

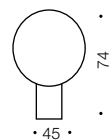

Product Approvals



Cob 6

Globe

Specifications

Type	Globe
Light Source	LED GU10
Lumen	500/520
Colour Temp	3000k/5000k
Wattage	6w
Dimmable	No
CRI	>80
Power Factor	>0.9
Beam Angle	60
Warranty	2 year*



Codes

GL GU10COB6-830

GL GU10COB6-850

Colours/Measurements

Clear

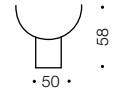

Product Approvals



Cob 8

Globe

Specifications

Type	Globe
Light Source	LED GU10
Lumen	520/540
Colour Temp	3000k/5000K
Wattage	8w
Dimmable	Optional
CRI	>80
Power Factor	>0.9
Beam Angle	60
Warranty	2 year*



Codes

GL GU10COB8LD-83

GL GU10COB8LD-85

GL GU10COB8-830

GL GU10COB8-850

Colours/Measurements

Clear

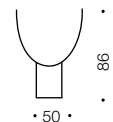

Product Approvals



T8 9w/18w

LED Tube

Specifications

Type	Globe
Light Source	LED
Lumen	900 1600/1700
Colour Temp	4000k/5000k
Wattage	9w/18w
Dimmable	No
CRI	>80
Power Factor	>0.8
Beam Angle	140
Warranty	2 year*



Codes

GL T8LED09-840

GL T8LED18-840

GL T8LED18-850

Colours/Measurements

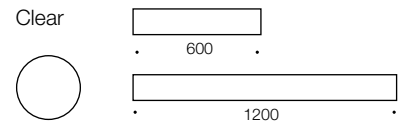

Product Approvals

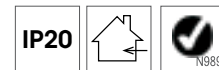

G9 LED

Globe

Specifications

Type	Globe
Light Source	LED
Lumen	120/160
Colour Temp	3000k/4000k
Wattage	2w
Dimmable	No
CRI	>80
Power Factor	>0.9
Beam Angle	360
Warranty	2 year*



Codes

GL G9LED2.0W-830

GL G9LED2.0W-840

Colours/Measurements



Product Approvals



E14 Halogen Globe

Specifications

Type	Globe
Light Source	28w 240v E14
Warranty	1 year*



Colours

Clear



Measurements

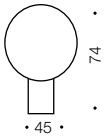

Codes

GL FR28W14-CL

Product Approvals

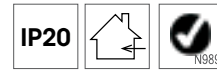

GU10 Halogen Globe

Specifications

Type	Globe
Light Source	Halogen
Lumen	350/550
Colour Temp	
Wattage	28w/35w 40w/50w
Dimmable	No
CRI	>80
Power Factor	1
Beam Angle	140
Warranty	1 year



Codes

1. GL GU10-28w-ES

2. GL GU10-35w-CL

3. GL GU10-40w-ES

4. GL GU10-50W-TRIO

Colours

Clear



Product Approvals



Incandescent Flame Candle

Specifications

Type	Globe
Light Source	40w B15
Warranty	1 year*



Colours

Clear



Measurements

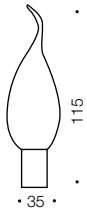

Codes

GL CAN.F.40WB 15C

Product Approvals

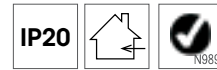

Par 6w Globe

Specifications

Type	Globe
Light Source	LED
Lumen	470
Colour Temp	4000k
Wattage	6w 240v
Dimmable	No
CRI	>80
Power Factor	>0.9
Beam Angle	60
Warranty	2 year*



Colours

Clear



Codes

GL GU10PAR6-840

Product Approvals



JC G4

bi-pin halogen

Specifications

Type	Globe
Light Source	Halogen
Colour Temp	3000k
Wattage	20w
Dimmable	Yes
CRI	>80
Power Factor	1
Beam Angle	360
Warranty	1 year*



Codes

GL JC.G4-20w

Colours

Clear



Product Approvals



G9 Halogen

Globe

Specifications

Type	Globe
Light Source	Halogen G9
Colour Temp	3000k
Wattage	28w/100w
Dimmable	Yes
CRI	>80
Power Factor	1
Beam Angle	360
Warranty	1 year*



Codes

GL G9 28w-clear

GL G9 100w-clear

Colours/Measurements

Clear

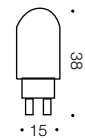

Product Approvals



MR11 SMD

Globe

Specifications

Type	Globe
Light Source	LED MR11
Lumen	80
Colour Temp	3000k
Wattage	1.6
Dimmable	No
CRI	>80
Power Factor	>0.8
Beam Angle	60
Warranty	2 year*



Codes

GL SMD.MR11-0.8W

Colours

Clear



Product Approvals



GU10 SMD

Globe

Specifications

Type	Globe
Light Source	LED GU10
Lumen	80
Colour Temp	3000k
Wattage	1.5w
Dimmable	No
CRI	>80
Power Factor	>0.9
Beam Angle	60
Warranty	2 year*



Codes

GL SMD.GU10-1.5W

Colours

Clear



Product Approvals



T5 R

Fluorescent/4pin

Specifications

Type	Globe
Light Source	Fluorescent
Warranty	1 year*
Dimmable	No



Measurements

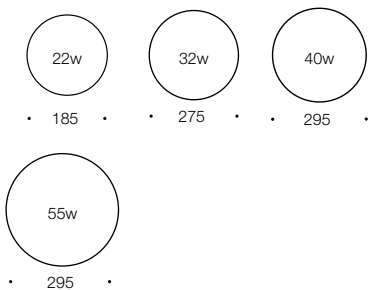

Codes

GL T5R-
22w-3000k

GL T5R-
22w-5000k

GL T5R-
32w-3000k

GL T5R-
40w-3000k

GL T5R-
40w-5000k

GL T5R-
50w-5000k

GL T5R-
50w-5000k

Colours

Clear



Product Approvals

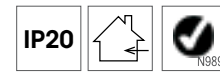

PL2

Fluorescent

Specifications

Type	Globe
Light Source	Fluorescent
Warranty	1 year*
Dimmable	No



Colours

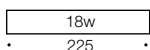
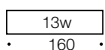

Codes

GL PL2-13w-2700k

GL PL2-18w-5000k

Colours

Clear



Product Approvals

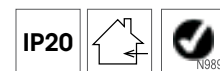

T5 Linear

Fluorescent

Specifications

Type	Globe
Light Source	Fluorescent
Warranty	1 year*
Dimmable	No



Measurements

8w	285
13w	535
14w	548
21w	835
28w/54w	1145

Codes

GL T5-08w-5000k

GL T5-13w-5000k

GL T5-14w-5000k

GL T5-21w-5000k

GL T5-28w-5000k

GL T5-54w-5000k

Colours

Clear



Product Approvals



S4

Globe

Specifications

Type	Globe
Light Source	LED GU10
Lumen	350
Colour Temp	4000k
Wattage	4w
Dimmable	No
CRI	>80
Power Factor	>0.6
Beam Angle	140
Warranty	2 year*



Codes

GL GU10S4-840

Colours

Clear



Product Approvals

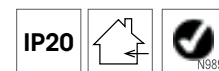

Puk Globe

Specifications

Type	Globe
Light Source	LED
Lumen	120
Colour Temp	3000k
Wattage	1.4
Dimmable	No
CRI	>80
Power Factor	>0.6
Beam Angle	140
Warranty	2 year*



Codes

GL Puk 1.4 G4-83

Colours

Clear



Product Approvals

IP20



® General Information

The description and dimensions of the items in this catalogue are indicative and may be modified for the purposes of the design or technical improvements. We reserve the right to cancel or change all models without prior notice.

We cannot accept any liability, nor is any liability on the part of Telbix to be implied as a result of the data given.

All hard wired electrical equipment must be installed by a qualified contractor. In accordance with the relevant installation standards, the guarantee is not valid.

Every product has a one year domestic use guarantee (60 day commercial use guarantee), unless otherwise specified. The guarantee excludes the globes supplied in the original packaging. If the products are faulty they will be replaced or repaired on return to place of purchase.

A copy of our trading terms and conditions is available upon request.

A GENERAL GUIDE FOR THE SAFE USE AND INSTALLATION OF LIGHTING

- 1.1 These notes have been prepared to ensure that information is available in relation to safety in handling, installation, and use of the related lighting products. The following notes are of a general nature; specific information regarding installation, maintenance, use and disposal appropriate to individual models is provided in the instruction leaflet supplied with the lighting products, or its packaging, and may also be shown in catalogues and leaflets.
- 1.2 Our products are designed to conform to the requirements of Australia and New Zealand standards. They should not be modified and any modification may render the product unsafe and will invalidate any safety/approvals marks. We will not accept any responsibility for any modified products or for any damage caused as a result of their modification.
- 1.3 Installation of our products should be carried out only by suitably qualified persons in accordance with AS/NZS 3000. If in any doubt consult a suitably qualified person.

Specific Requirements

- 2.1 Our products, unless specifically stated otherwise, are intended for lighting purposes only.
- 2.2 Where a lighting product instruction sheet is provided the instructions should be followed correctly and retained with the installation for future reference.
- 2.3 Ensure that the rated voltage/frequency of the lighting product is compatible with the mains supply.
- 2.4 Installations should be carried out in accordance with the local wiring rules (AS/NZS 3000).
- 2.5 The supply should be isolated before any electrical work is undertaken.
- 2.6 Our products are designed for operation in normal ambient temperature.
- 2.7 Unless otherwise marked or stated, all of our lighting products are designed for operation in normal indoor conditions and rated IP20. Do not use in damp, dusty or corrosive situations. In these circumstances our lighting product will have the appropriate IP rating and resistance to corrosion should be used.
- 2.8 When making the electrical supply connections observe the correct polarity indicated by colour coding of wires or marking of terminals. To comply with EMC regulations ensure that the mains supply cable is as short as possible within the lighting product. Do not place the cable close to the internal wiring, particularly important if through wiring.
- 2.9 If mains is connected to the low voltage circuit permanent damage to components will occur and may be hazardous.
- 2.10 Ensure that all of our lighting product are reliably earthed where required.
- 2.11 Observe the correct mounting orientation limitations of the lighting product which may in some cases be restricted by the lamp (see data supplied with lamp). Ensure that the lighting product is reliably and securely fixed to an appropriate mounting surface.
- 2.12 Attention should be paid to the temperature limits imposed by the material of the mounting surface including conduit boxes of plastic material. Cables with suitable insulation temperature ratings should be selected and additional cable shrouding should be fitted.
- 2.13 Use only lamps of the recommended type and rating and follow the lamp manufacturer's instructions. Observe particularly the rated wattage specified for the lighting product.

Operation and Maintenance

- 3.1 The lighting product must not be covered by heat insulating material or by any other material which may prevent heat dissipation.
- 3.2 All lamp types operate at high temperatures. Care must be taken when adjusting or re-lamping the luminaire.
- 3.3 To avoid damage, failed lamps should be replaced promptly and the lighting product should be switched off as soon as lamp failure is noted. Replacement lamps should be of the same type. Always ensure lamps are fully inserted.
- 3.4 Repairs should be carried out only by suitably qualified persons. Only replacement components authorised by the company may be used.
- 3.5 Replace all cracked or damaged glassware immediately.
- 3.6 Servicing should only be carried out after the lighting product has been made electrically safe.
- 3.7 Cleaning should be carried out at regular intervals to ensure the dirt and debris does not accumulate to an extent that will impair the electrical and/or thermal safety of the lighting product. Regular cleaning will also ensure that the performance is maintained.

ALL ELECTRICAL INSTALLATIONS MUST BE PERFORMED BY A QUALIFIED ELECTRICAL CONTRACTOR AND INSTALLED IN ACCORDANCE WITH AS/NZS 3000.

A GENERAL GUIDE FOR MATERIAL MAINTENANCE

- 4.1 **Fabric shades.** Use a fine brush or a lint remover on your lampshade to remove the accumulated dirt and dust. If necessary, you may use a white cloth dampened with a mild solution of soapy water to wash the shade gently and evenly. Rinse thoroughly with a white cloth dipped in clean water.
- 4.2 **Mild steel** that has been painted, plated or polished must only be cleaned with a soft dry cloth. Do not use any harsh abrasives, polishes or chemicals.
- 4.3 **Aluminium** and its alloys generally are more corrosion resistant compared to other metals but are subject to anodic oxidation of the surface from moisture and condensation. To improve durability the surface may be powder coated to create a barrier against oxidation. Build up of soils and other grime can hold moisture to the coated surface, and this is detrimental to powder coatings and polished surface finishes. This build up can facilitate a corrosive/oxidising condition which may lead to damage of the coating, particularly in a coastal or salt air environment. To clean use a clean damp non abrasive fibre cloth on the surface and dry thoroughly on completion.
- 4.4 **Stainless steel** is often thought to be a maintenance-free material. However, it is not a metal that never rusts and is not completely maintenance-free. Rather, it should be termed a material whose beauty can be retained semi-permanently with proper cleaning and maintenance.

Both exterior and interior building components require routine cleaning, the frequency of which is dependent upon environmental conditions and aesthetic requirements.

Stainless steel may become discoloured or show surface rust. The risk of corrosion increases in harsh environments. Stainless steel must never be sprayed with pesticides or with other sprays used for gardening maintenance as this will accentuate the discoloration.

Cleaning intervals: (304) 2-6 months. (316) 6 months.

Clean with mild, non-scratching creams and polishes. The surface should not be cleaned with products that contain iron or chlorine solutions. Apply with soft cloth or soft sponge, rinse off residues with clean water and dry. For stubborn stains use a stainless steel cleaning agent and follow the directions of the brush lines on the surface.

If installed in harsh environments (damp or salty atmosphere) the product will require additional and more frequent maintenance. Before installation treat all metal parts with a neutral oil such as RP7, WD40 or equivalent and remove excess oil with a soft dry cloth. Apply treatment at every cleaning cycle.

ALL ELECTRICAL INSTALLATIONS MUST BE PERFORMED BY A QUALIFIED ELECTRICAL CONTRACTOR AND INSTALLED IN ACCORDANCE WITH AS/NZS 3000.

NOTE: Alterations in design, manuals and technical specification reserved.