



www.sal.net.au



2016 - 2017
PRODUCT CATALOGUE



SAL LIGHTS UP THE FUTURE WITH LED

SAL (Sunny Australia Lighting) is a major quality lighting product distributor in the Australian lighting market. We are a 100% Australian owned and operated national Lighting company. We endeavour to supply our wide range of loyal customers – from independent Local lighting retailers to national electrical wholesale groups – premium quality products with Integrated professional services.

Ground breaking and fast developing LED technology means product innovation is always our **H**ighest priority. LED products first appeared in our 2006 catalogue and SAL's 2016-2017 catalogue is **T**he first "cover-to-cover all LED catalogue". The defining character for a product to be **S**electd into this catalogue is if it is LED related. As always, we are committed to **U**timize our long established and ever growing network of local and overseas suppliers to **P**rovide our customers with the right LED products in a timely manner.

There have been many additions to the SAL product range throughout last year to meet what **H**as been a huge demand for SAL products in the Commercial Project Lighting market. International **E**MC requirements and Australian safety standards compliance, high quality and continued strong **F**ocus on stock availability will enable SAL products to be specified with confidence. We will also **U**nreservedly advance our LED luminaries in the residential market.

The new warehouse spaces taken up in Perth, will enable us to establish a brand new sales **U**nit in order to improve services to our Western Australian customers. Our dedicated sales **R**epresentatives, SAL agents, internal customer service officers and supporting staff are all **E**ngaged in providing our customers – our friends, the most rewarding purchasing experiences **W**hilst dealing with us. Our current operating capacity will ensure that SAL products are available **I**n all Australian States and Territories.

Together with our customers, we at SAL are confident in providing a wide range of products that are **H**ighly user friendly and energy efficient. Like what is commonly referred to as Moore's **L**aw in computing, lighting technologies such as LED lumen output per watt are increasing **E**veryday. We ensure that all our products will transform, improve and expand, as we are **D**etermined to be "The Lighting Company that Lights Up the Future with LED".

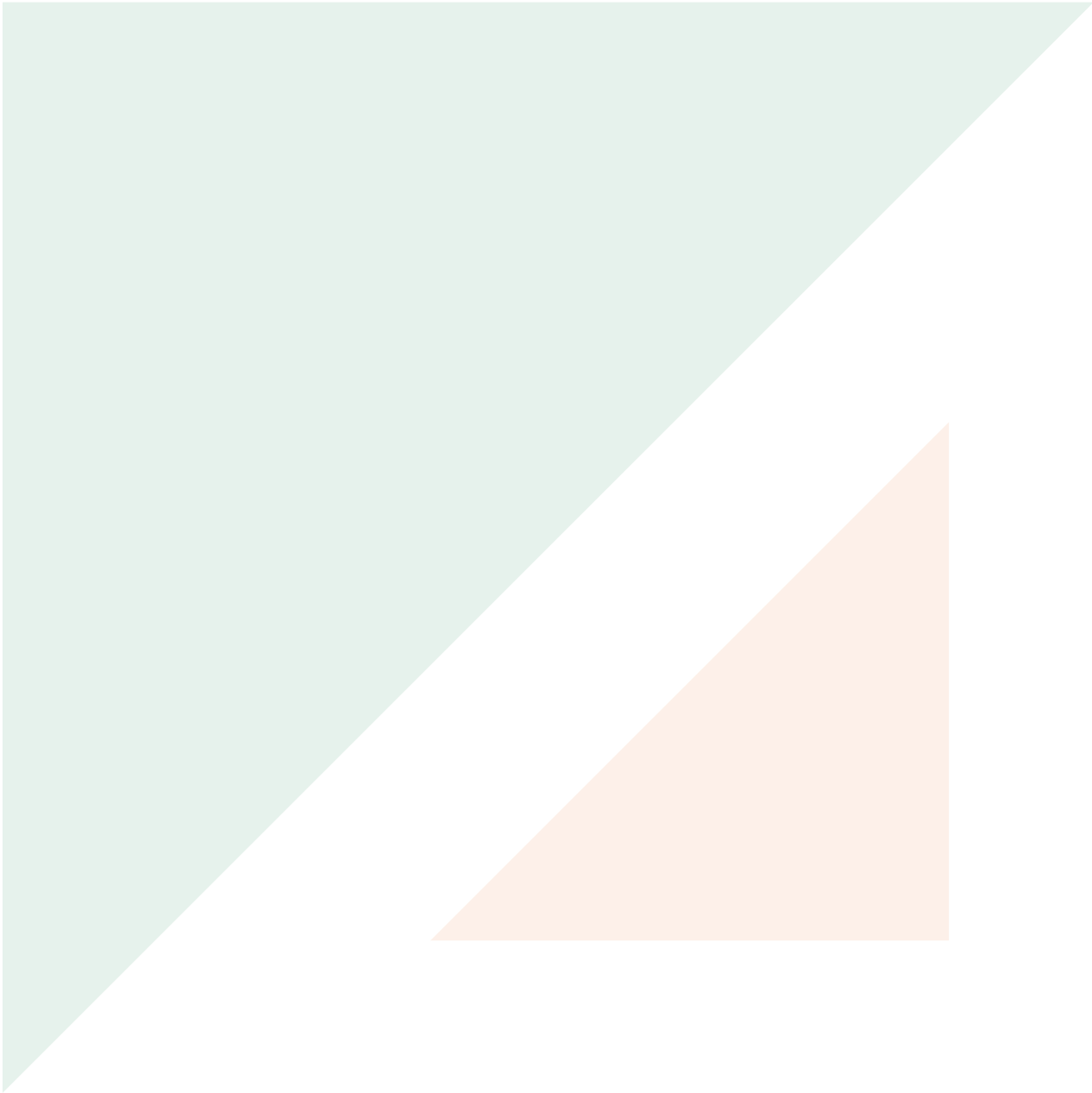

CONTENTS



LED DOWNLIGHTS



LED OYSTER & PENDANT LIGHTS

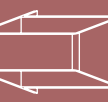

LED CABINET & WALL LIGHTS

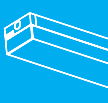

LED LINEAR & PROFILES



LED PANELS & TROFFERS

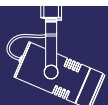

LED TRACK LIGHTS

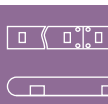

LED STRIPS



EXTERIOR DOMESTIC LEDS



EXTERIOR COMMERCIAL LEDS



LAMPS, DRIVERS & ACCESSORIES

PRODUCT FINDER



LED DOWNLIGHTS

 <p>p3 S9040 ECOGEM</p>	 <p>p4 S9040SM SM-ECOGEM</p>	 <p>p5 S9041 ECOGEM</p>	 <p>p6 S9041 S ECOGEM</p>	 <p>p7 S9041SM SM-ECOGEM</p>
 <p>p8 S9141 TRADER</p>	 <p>p9 S9141SM SM-TRADER</p>	 <p>p10 S9841 TRI-GEM</p>	 <p>p11 S9841SM SM-TRI-GEM</p>	 <p>p12 S9049 DISK</p>
 <p>p13 S9064 WAVE</p>	 <p>p14 S9065 WAVE</p>	 <p>p15 S9066 WAVE</p>	 <p>p17 S9865 TRI-WAVE</p>	 <p>p19 S9081, S9083 EXCEL</p>
 <p>p20 S9045 ECOSTAR</p>	 <p>p21 S9046 ECOSTAR</p>	 <p>p22 S9048 ECOSTAR</p>	 <p>p23 S9045SM SM-ECOSTAR</p>	 <p>p24 S9046SM, S9048SM SM-ECOSTAR</p>
 <p>p25 S9071, S9072, S9073 PREMIER</p>	 <p>p27 S9074, S9075, S9076 PREMIER</p>	 <p>p29 S9514 ALBANY</p>	 <p>p30 S9522 EXMOUTH</p>	 <p>p31 S9523 EXMOUTH</p>
 <p>p32 S9523SM SM-EXMOUTH</p>	 <p>p33 S9535 NEWMAN MKII</p>	 <p>p34 S9545 NEWMAN MKII</p>	 <p>p35 S9656, S9658 UNI LED</p>	 <p>p37 S9520 SEYMOUR S9530 MANSFIELD</p>

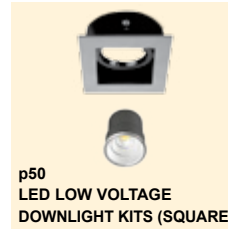
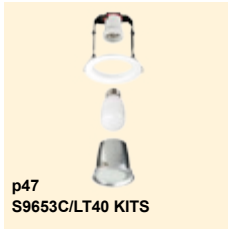

LED OYSTER & PENDANT LIGHTS

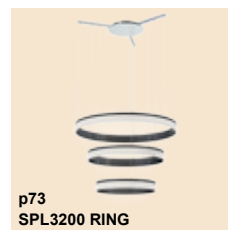
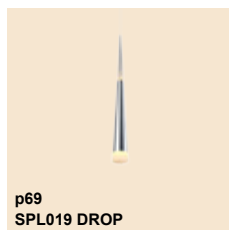

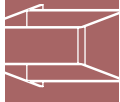

LED CABINET & WALL LIGHTS



p77
S9105, S9105 SR, S9105 ST
ANOVA



p78
S9113, S9114, S9115 DISC



p79
S9511/LED, S9512/LED
DESERT



p80
S9515 BEACON



p81
S9316, S9317 DARHAM



p82
S9318 LEEMAN



p83
S9311 BROOM



p84
S9327, S9328 LOUNGE I & II



p85
S9320 CUBE



p86
S9356 UD

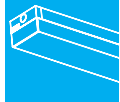

LED LINEAR & PROFILES



p89
STB/106, STB/206, STB/112,
STB/212 TUBELINE



p90
STB/206EM2500,
STB/212EM2500 TUBELINE



p91
STD/106, STD/206, STD/112,
STD/212 TUBELINE



p92
STD/206EM2500,
STD/212EM2500 TUBELINE



p93
STG/106, STG/206, STG/112,
STG/212 TUBELINE



p94
STG/206EM2500,
STG/212EM2500 TUBELINE



p95
SLD2000, SLD4000 LEDLINE



p97
S9733 WIDELINE T8



p99
S9733L WIDELINE LED



p100
SL3147/306, SL3147/312
FLORIO



p101
SL9706
SEAMLESS SLIMLINE



p103
S9775 PHOENIX



p105
SL9707 BLADE



p106
SL9709 BLADE



LED PANELS & TROFFERS



p109
S9714 LED PANEL



p111
S9714HO/TC
HIGH OUTPUT LED PANEL



p112
S9714 LOW COI HIGH CRI
LED PANEL



p113
S9714SM SURFACE
MOUNTED FRAME



p114
S9714PF RECESSED
CEILING FRAME



p115
S9714SP SUSPENSION UNITS



p116
S9714AS LED PANEL WITH
AIR SLOT FRAME

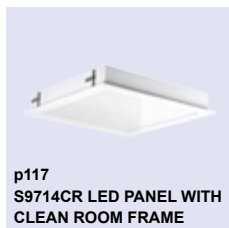

p117
S9714CR LED PANEL WITH
CLEAN ROOM FRAME



p119
S9724 L-LINE T8
LED LOUVER TROFFER



p121
S9734 L-LINE MKII



p122
S9725 ORION

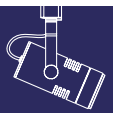

LED TRACK LIGHTS



p125
STR4800/1, STR4800/2
UNIVERSAL



p127
STR4855L, STR4856L
SPOT I



p128
STR4863LV WH SPOT III



p129
STR4863GU SPOT II



p130
STR4861 SPOTTY I

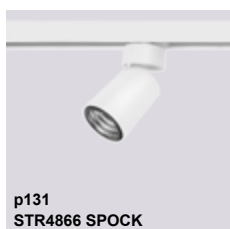

p131
STR4866 SPOCK

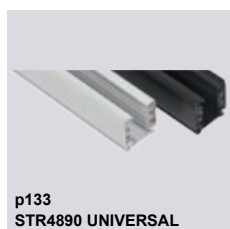

p133
STR4890 UNIVERSAL



p135
STR4881 UNIVERSAL I



p136
STR4882 UNIVERSAL II



p137
STR4883 UNIVERSAL III



p139
STR4886 SPOCK



p140
STR3/4863GU SPOT IV



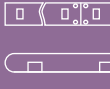

LED STRIPS

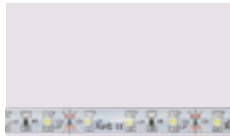

p145
FL1209/S

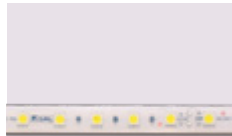

p145
FL1209/SR



p146
FL1206 S

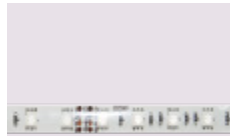

p147
FL2415RGB/S



p148
FLH2420



p149
FLP12V2M, FLP12V5M



p150
FLP12V5M/RGB



p151
SLT1000



p151
SLT2000



p151
SLT3000



p152
SLT4000



p152
SLT4050



p152
SLT5000

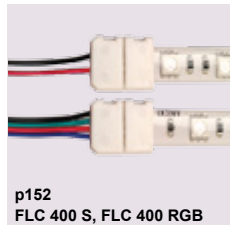

p152
FLC 400 S, FLC 400 RGB



p153
LT8903 DIM



p153
LT8903 RGB



p155
LT8904 DIM/RP



p155
LT8904 RGB/RP



p157
LT8905 DIM

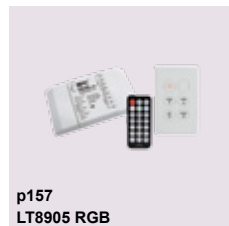

p157
LT8905 RGB



EXTERIOR DOMESTIC LEDS



p161
SE7071 STARPAD



p163
SE7174 NEW STAR



p165
SE7080/1, SE7080/2
STARGEM



p166
SES7080/1, SES7080/2
STARGEM



p167
SES7090/2 BATWING



p168
SPK1000, SPK2000
STARLIGHT



p169
SPSK1000, SPSK2000
STARLIGHT



p170
SE7273 LUCIA



p171
SE7253, SE7254, SE7255
C-SERIES



p172
SE7250, SE7251, SE7252
M-SERIES



p173
SL7269, SL7270 BUTTON



p174
SL7266 MINI SPIKE



p174
S9337 BREMER



p175
SL7261, SL7264
NEWPORT SPIKE



p176
S9338 GROUND



p177
S9321LV HILLSTONE



p177
S9324 HILLSTONE



p178
S9325, S9326 HILLSTONE



p179
SL7262, SL7267 NEWPORT



p180
SL7263, SL7268 NEWPORT



p181
S9329, S9330 NARRABEEN



p182
SE7258, SE7259, SE7260
SQUARE



p183
S9355 CUBIC

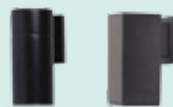

p184
SE7031, SE7033 MAXI



p185
SE7133, SE7134 ETON

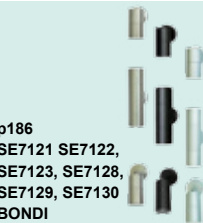

p186
SE7121 SE7122,
SE7123, SE7128,
SE7129, SE7130
BONDI



p187
SL7221, SL7222 NEW BONDI



p189
SE7131, SE7132
NEW FLINDERS WALL



p190
SE7061
NEW FLINDERS POST

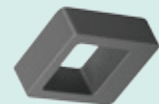

p192
SE7062 LACHLAN WALL



p193
SE7062 LACHLAN POST

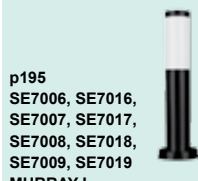

p195
SE7006, SE7016,
SE7007, SE7017,
SE7008, SE7018,
SE7009, SE7019
MURRAY I



p197
SE7085, SE7086 SWAN



p198
SE7051, SE7053 YARRA





EXTERIOR COMMERCIAL LEDS

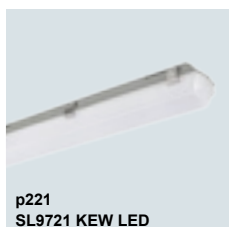



p227
S9348, S9349 PATHWAY



p228
S9351, S9352 PATHWAY



p229
S9353, S9354 TORCH



p230
SE7079 DECOSTAR



p231
SE7099 MAXISTAR



p233
SHB14/120 SHB14/120MD
SHB14/120PD
MINI SATELLITE



p234
SHB14/200, SHB14/200 MD
SHB14/300, SHB14/300 MD
MAXI SATELLITE



p235
SHB22/140, SHB22/240
EAGLE



p236
SHP100 SPARK



p237
SE7103 SE7104, SE7105,
SE7106 BOLLARD



p238
SLA7102, SE7102/LGLS
BOLLARD



LAMPS, DRIVERS & ACCESSORIES



p241
MR16 LED LAMP



p242
GU10 LED LAMP



p243
G4L LED LAMP



p243
G9 LED LAMP



p244
GX53 LED LAMP



p245
LT407, LT409
TUBULAR LAMPS



p246
LR50, LR63, LR80, LR95
LED R LAMPS



p247
LPAR20, LPAR30, LPAR38
LED PAR LAMPS



p248
LG95, LG125
LED SPHERICAL LAMPS



p249
LG3, LG5, LG7, LG9
GLS LED LAMPS



p250
LGS4, LGS8, LGS10
ECO SERIES



p251
LGS11D
ECO SERIES DIMMABLE



p252
LCA35 CANDLE LED LAMP



p253
LFR35 FANCY ROUND
LED LAMP



p254
LT25 FILAMENT TUBULAR
LED LAMP



p255
LCAF FILAMENT CANDLE
LED LAMPS



p256
LG6 DIMMABLE FILAMENT
GLS LED LAMP



p257
LG125F FILAMENT
SPHERICAL LED LAMP



p258
LST21FD, LG125FD FILAMENT
DECO LED LAMPS



p259
LT8 T8 LED TUBE



p260
AR111 LED LAMP



p260
AR111 LED MODULES



p261
SLC21, SLC30
CONVERSION KITS



p262
PLUTO EGL, PLUTO
LED DRIVER



p263
DIM40W/12V DIMMABLE
CONSTANT CURRENT
VOLTAGE DRIVER



p264
PLUTO, DIM DIMMABLE
CONSTANT CURRENT LED
DRIVERS



p265
MINI ELECTRONIC
TRANSFORMERS



p266
ST105, ST150, ST200,
ST300, ST400



p266
SELK2500/SM TRIANGLE
LED EMERGENCY KIT



p267
SELK1500/SF S-FIRE



p268
SDD350TCM, SDD350TCS
TRAILING EDGE DIMMER



p268
SDA450, SDF30



p269
ESS101 QUICK CONNECT
SURFACE SOCKET



p269
ESS102 SURFACE SOCKET



p270
2S9000



p270
3S9000



p270
SGU9000LH



p270
CONVERTER M/LV



p270
SLH100

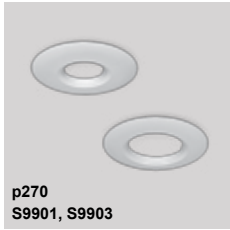

p270
S9901, S9903



p270
S9922



p271
SSI1512, SSI1512



p271
S9913



p272
SMS800 SENSOR



p273
SMS810 SENSOR



p274
SMS801WF SENSOR



p275
SMS802WR SENSOR



p276
SMS803CD SENSOR



p277
SMS804CR SENSOR



p278
SMS805CS SENSOR



LED DOWNLIGHTS



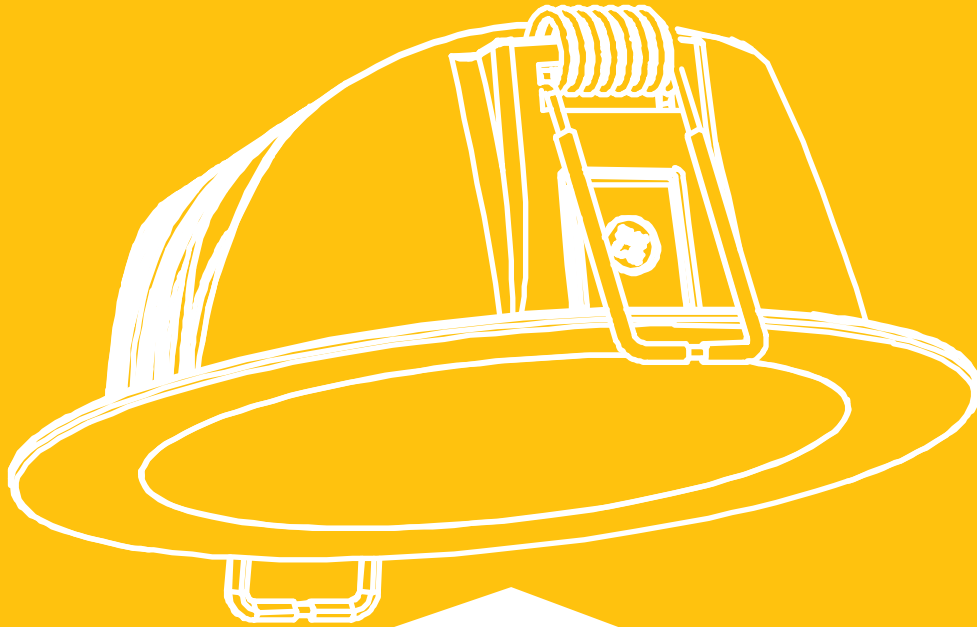

S9040 ECOGEM	3	S9535 NEWMAN MKII	33
S9040SM SM-ECOGEM	4	S9545 NEWMAN MKII	34
S9041 ECOGEM	5	S9656, S9658 UNI LED	35
S9041 S ECOGEM	6	S9520 SEYMOUR, S9530 MANSFIELD	37
S9041SM SM-ECOGEM	7	L21022, L21021, L21012, L21011 EUROPA	39
S9141 TRADER	8	S9053 UNIFIT	41
S9141SM SM-TRADER	9	S9902F-S9053 FIREFOX	43
S9841 TRI-GEM	10	S9145, S9146 ECOSTAR II	44
S9841SM SM-TRI-GEM	11	S9006, S9007, S9008, S9009 UNIFIT	45
S9049 DISK	12	S9653C/LT40 KITS	47
S9064 WAVE	13	LED GU10 DOWNLIGHT KITS	48
S9065 WAVE	14	LED LOW VOLTAGE DOWNLIGHT KITS (ROUND)	49
S9066 WAVE	15	LED LOW VOLTAGE DOWNLIGHT KITS (SQUARE)	50
S9865 TRI-WAVE	17		
S9081, S9083 EXCEL	19		
S9045 ECOSTAR	20		
S9046 ECOSTAR	21		
S9048 ECOSTAR	22		
S9045SM SM-ECOSTAR	23		
S9046SM, S9048SM SM-ECOSTAR	24		
S9071, S9072, S9073 PREMIER	25		
S9074, S9075, S9076 PREMIER	27		
S9514 ALBANY	29		
S9522 EXMOUTH	30		
S9523 EXMOUTH	31		
S9523SM SM-EXMOUTH	32		

DIMMABLE LED DOWNLIGHT

S9040 ECOGEM

CONSTRUCTION

- Die-cast aluminium body
- Powder coated or plated finish
- Opal acrylic diffuser
- High efficiency SMD LED chips
- Trailing edge dimmable LED driver included
- 1.2 m flex and plug fitted

IP RATING

- IP44 weatherproof

DIMMING OPTIONS

- 1-10V dimming
- Digital dimming (DSI, DALI)

APPLICATIONS

- Residential
- Hotels
- Shops
- Conference Rooms
- Reception areas



DIMENSIONS

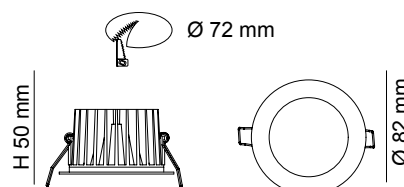

Model No.	Input	Power	Lumen	CCT	CRI	Beam Angle	Dimmable	Fitting Colour
S9040 WW WH	240V	10W	700lm	3000K	>80	90°	Yes	White
S9040 CW WH	240V	10W	780lm	4000K	>80	90°	Yes	White
S9040 DL WH	240V	10W	800lm	6000K	>80	90°	Yes	White
S9040 WW SN	240V	10W	700lm	3000K	>80	90°	Yes	Satin Nickel
S9040 CW SN	240V	10W	780lm	4000K	>80	90°	Yes	Satin Nickel
S9040 DL SN	240V	10W	800lm	6000K	>80	90°	Yes	Satin Nickel

PHOTOMETRIC DATA

Unit: cd

S9040 WW

C0/C180 ———
C90/C270 ———

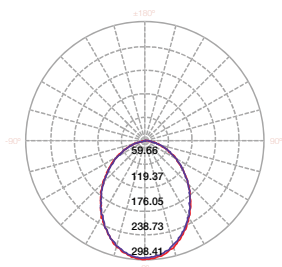

S9040 DL

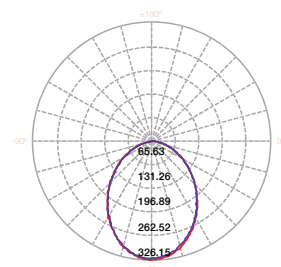

DIMMABLE LED DOWNLIGHT

S9040SM SM-ECO GEM

CONSTRUCTION

- Extruded aluminium surface mount casing
- Powder coated finish
- S9040 LED downlight kit included

IP RATING

- IP44 weatherproof

DIMMING OPTIONS

- 1-10V dimming
- Digital dimming (DSI, DALI)

APPLICATIONS

- Residential
- Hotels
- Shops
- Conference Rooms
- Reception areas



DIMENSIONS

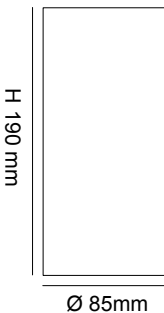

Model No.	Input	Power	Lumen	CCT	CRI	Beam Angle	Dimmable	Fitting Colour
S9040SM/C WW WH	240V	10W	700lm	3000K	>80	90°	Yes	White
S9040SM/C CW WH	240V	10W	780lm	4000K	>80	90°	Yes	White
S9040SM/C DL WH	240V	10W	800lm	6000K	>80	90°	Yes	White

PHOTOMETRIC DATA

Unit: cd

S9040 WW

C0/C180 ————
C90/C270 ————

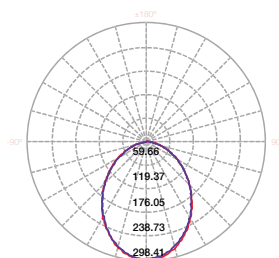

S9040 DL

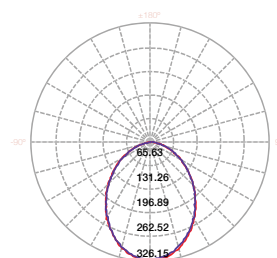

DIMMABLE LED DOWNLIGHT

S9041 ECOGEM

CONSTRUCTION

- Die-cast aluminium body
- Powder coated or plated finish
- Opal acrylic diffuser
- High efficiency SMD LED chips
- Trailing edge dimmable LED driver included
- 1.2 m flex and plug fitted

IP RATING

- IP44 weatherproof

DIMMING OPTIONS

- 1-10V dimming
- Digital dimming (DSI, DALI)

APPLICATIONS

- Residential
- Hotels
- Shops
- Conference Rooms
- Reception areas



DIMENSIONS

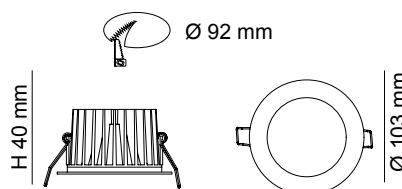

Model No.	Input	Power	Lumen	CCT	CRI	Beam Angle	Dimmable	Fitting Colour
S9041 WW WH	240V	10W	700lm	3000K	>80	90°	Yes	White
S9041 CW WH	240V	10W	780lm	4000K	>80	90°	Yes	White
S9041 DL WH	240V	10W	800lm	6000K	>80	90°	Yes	White
S9041 WW SL	240V	10W	700lm	3000K	>80	90°	Yes	Silver
S9041 DL SL	240V	10W	800lm	6000K	>80	90°	Yes	Silver
S9041 WW SN	240V	10W	700lm	3000K	>80	90°	Yes	Satin Nickel
S9041 CW SN	240V	10W	780lm	4000K	>80	90°	Yes	Satin Nickel
S9041 DL SN	240V	10W	800lm	6000K	>80	90°	Yes	Satin Nickel
S9041 WW BK	240V	10W	700lm	3000K	>80	90°	Yes	Black
S9041 CW BK	240V	10W	780lm	4000K	>80	90°	Yes	Black
S9041 DL BK	240V	10W	800lm	6000K	>80	90°	Yes	Black

PHOTOMETRIC DATA

Unit: cd

S9041 WW

C0/C180 ————
C90/C270 ————

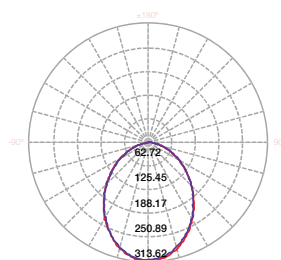

S9041 DL

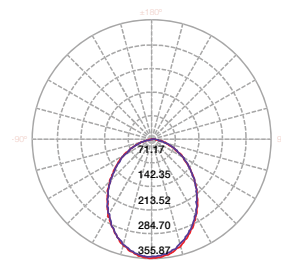

www.sal.net.au

DIMMABLE LED DOWNLIGHT

S9041 S ECOGEM

CONSTRUCTION

- Die-cast aluminium body
- Powder coated or plated finish
- Opal acrylic diffuser
- High efficiency SMD LED chips
- Trailing edge dimmable LED driver included
- 1.2 m flex and plug fitted

IP RATING

- IP44 weatherproof

DIMMING OPTIONS

- 1-10V dimming
- Digital dimming (DSI, DALI)

APPLICATIONS

- Residential
- Hotels
- Shops
- Conference Rooms
- Reception areas



DIMENSIONS

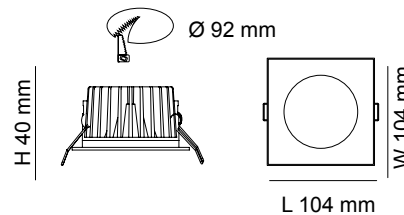

Model No.	Input	Power	Lumen	CCT	CRI	Beam Angle	Dimmable	Fitting Colour
S9041 S WW WH	240V	10W	700lm	3000K	>80	90°	Yes	White
S9041 S CW WH	240V	10W	780lm	4000K	>80	90°	Yes	White
S9041 S DL WH	240V	10W	800lm	6000K	>80	90°	Yes	White
S9041 S WW SN	240V	10W	700lm	3000K	>80	90°	Yes	Satin Nickel
S9041 S CW SN	240V	10W	780lm	4000K	>80	90°	Yes	Satin Nickel
S9041 S DL SN	240V	10W	800lm	6000K	>80	90°	Yes	Satin Nickel

PHOTOMETRIC DATA

Unit: cd

S9041 S WW

C0/C180 ———
C90/C270 ———

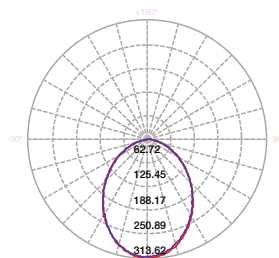

S9041 S DL

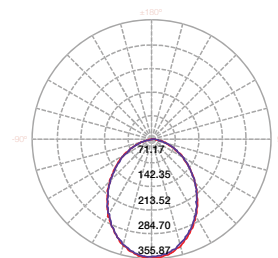

DIMMABLE LED DOWNLIGHT

S9041SM SM-ECO GEM

CONSTRUCTION

- Pressed metal surface mount casing
- Powder coated finish
- S9041 LED downlight kit included

IP RATING

- IP20 suitable for indoor use only

DIMMING OPTIONS

- 1-10V dimming
- Digital dimming (DSI, DALI)

APPLICATIONS

- Residential
- Hotels
- Shops
- Conference Rooms
- Reception areas



DIMENSIONS

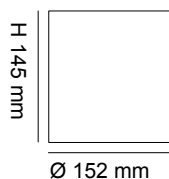

Model No.	Input	Power	Lumen	CCT	CRI	Beam Angle	Dimmable	Fitting Colour
S9041SM/C WW WH	240V	10W	700lm	3000K	>80	90°	Yes	White
S9041SM/C CW WH	240V	10W	780lm	4000K	>80	90°	Yes	White
S9041SM/C DL WH	240V	10W	800lm	6000K	>80	90°	Yes	White

PHOTOMETRIC DATA

Unit: cd

S9041 WW

C0/C180 ————
C90/C270 ————

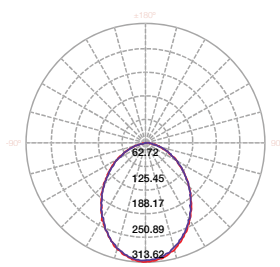

S9041 DL

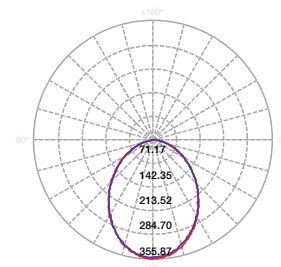

DIMMABLE LED DOWNLIGHT

S9141 TRADER

CONSTRUCTION

- Die-cast aluminium body
- Powder coated finish
- Opal acrylic diffuser
- High efficiency SMD LED chips
- Trailing edge dimmable LED driver included
- 1 m flex and plug fitted

IP RATING

- IP44 weatherproof

DIMMING OPTIONS

- 1-10V dimming
- Digital dimming (DSI, DALI)

APPLICATIONS

- Residential
- Hotels
- Shops
- Conference Rooms
- Reception areas



DIMENSIONS

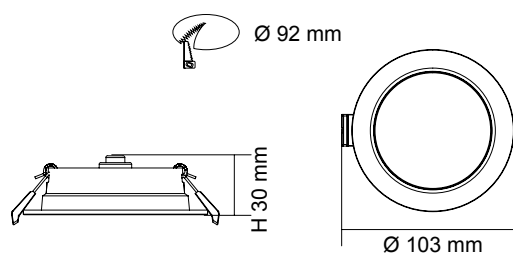

Model No.	Input	Power	Lumen	CCT	CRI	Beam Angle	Dimmable	Fitting Colour
S9141WW/WH	240V	10W	800lm	3000K	>80	100°	Yes	White
S9141CW/WH	240V	10W	850lm	4000K	>80	100°	Yes	White
S9141DL/WH	240V	10W	900lm	5700K	>80	100°	Yes	White

DIMMABLE LED DOWNLIGHT

S9141SM SM-TRADER

CONSTRUCTION

- Pressed metal surface mount casing
- Powder coated finish
- S9141 LED downlight kit included

IP RATING

- IP20 suitable for indoor use only

DIMMING OPTIONS

- 1-10V dimming
- Digital dimming (DSI, DALI)

APPLICATIONS

- Residential
- Hotels
- Shops
- Conference Rooms
- Reception areas



DIMENSIONS

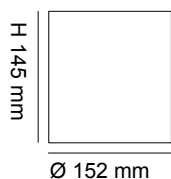

Model No.	Input	Power	Lumen	CCT	CRI	Beam Angle	Dimmable	Fitting Colour
S9141SM/C WW WH	240V	10W	800lm	3000K	>80	100°	Yes	White
S9141SM/C CW WH	240V	10W	850lm	4000K	>80	100°	Yes	White
S9141SM/C DL WH	240V	10W	900lm	5700K	>80	100°	Yes	White

DIMMABLE LED DOWNLIGHT COLOUR TEMPERATURE CHANGEABLE S9841 TRI-GEM

ICF
ABUTTED &
COVERED



3000K

4000K

5700K

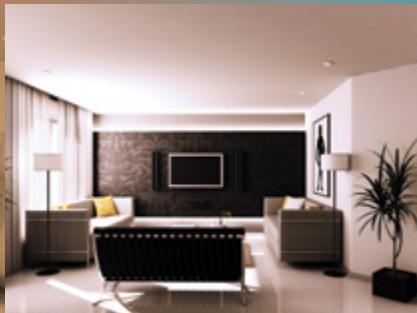

3 COLOUR TEMPERATURE CHANGEABLE WITH

- Standard switch: on / off twice or
- Recommended dimmer (SDD350TCM): double click

CONSTRUCTION

- Die-cast aluminium body
- Powder coated finish
- Opal acrylic diffuser
- High efficiency SMD LED chips
- Trailing edge dimmable LED driver included
- 1.2 m flex and plug fitted

IP RATING

- IP44 weatherproof

DIMENSIONS

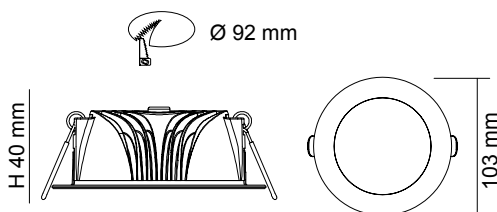

COLOUR TEMPERATURE CHANGEABLE

- 3000K
- 4000K
- 5700K

APPLICATIONS

- Residential
- Hotels
- Restaurants
- Conference Rooms

Model No.	Input	Power	Lumen	CCT	CRI	Beam Angle	Dimmable	Fitting Colour
S9841WH	240V	10W	800lm	3000K, 4000K, 5700K	>80	90°	Yes	White

DIMMABLE LED DOWNLIGHT COLOUR TEMPERATURE CHANGEABLE S9841SM SM-TRI-GEM

CONSTRUCTION

- Pressed metal surface mount casing
- Powder coated finish
- S9841 LED downlight kit included

COLOUR TEMPERATURE CHANGEABLE

- 3000K
- 4000K
- 5700K

IP RATING

- IP20 suitable for indoor use only

APPLICATIONS

- Residential
- Hotels
- Restaurants
- Conference Rooms



DIMENSIONS

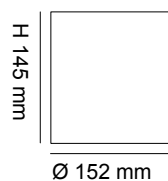

Model No.	Input	Power	Lumen	CCT	CRI	Beam Angle	Dimmable	Fitting Colour
S9841SM	240V	10W	800lm	3000K, 4000K, 5700K	>80	90°	Yes	White



DIMMABLE LED DOWNLIGHT

S9049 DISK

CONSTRUCTION

- Die-cast aluminium heat sink
- Powder coated finish
- High efficiency SMD LED chips
- Trailing edge dimmable LED driver included
- 1.2 m flex & plug fitted

COLOUR TEMPERATURE

- 3000K WARM WHITE
- 6000K DAYLIGHT

IP RATING

- IP44 weatherproof

DIMMING OPTIONS

- 1-10V dimming
- Digital dimming (DSI, DALI)

DIMENSIONS

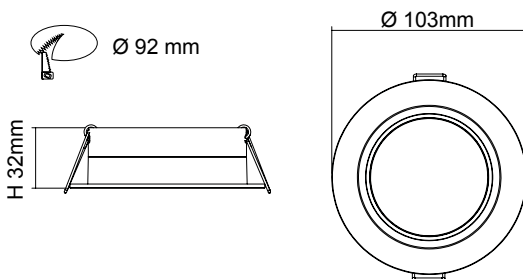

Model No.	Input	Power	Lumen	CCT	CRI	Beam Angle	Dimmable	Fitting Colour
S9049 WW WH	240V	10W	750lm	3000K	>80	90°	Yes	White
S9049 DL WH	240V	10W	800lm	6000K	>80	90°	Yes	White

PHOTOMETRIC DATA

Unit: cd

S9049 WW

C0/C180 ————
C90/C270 ————

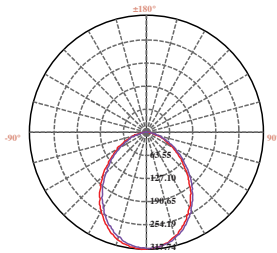

S9049 DL

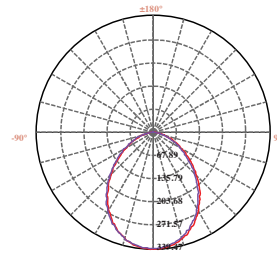

DIMMABLE LED DOWNLIGHT

S9064 WAVE

CONSTRUCTION

- Poly covered aluminium body
- Opal acrylic diffuser
- Double insulation
- High efficiency SMD LED chips
- Built-in trailing edge dimmable LED driver
- 1.2 m flex & plug fitted
- Integrated design, easy installation

IP RATING

- IP44 weatherproof

APPLICATIONS

- Residential
- Hotels
- Shops
- Conference Rooms
- Reception areas

DIMENSIONS

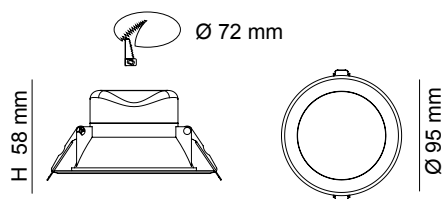

Model No.	Input	Power	Lumen	CCT	CRI	Beam Angle	Dimmable	Fitting Colour
S9064WW WH	240V	7W	500lm	3000K	>80	90°	Yes	White
S9064CW WH	240V	7W	550lm	4000K	>80	90°	Yes	White
S9064DL WH	240V	7W	600lm	6000K	>80	90°	Yes	White

PHOTOMETRIC DATA

Unit: cd

S9064DL

C0/C180 ———
C90/C270 ———

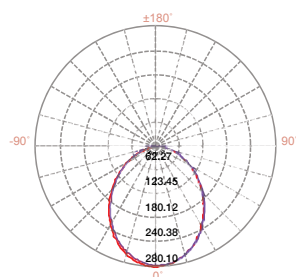

DIMMABLE LED DOWNLIGHT

S9065 WAVE

CONSTRUCTION

- Poly covered aluminium body
- Opal acrylic diffuser
- Double insulation
- High efficiency SMD LED chips
- Built-in trailing edge dimmable LED driver
- 1.2 m flex & plug fitted
- Integrated design, easy installation

IP RATING

- IP44 weatherproof

APPLICATIONS

- Residential
- Hotels
- Shops
- Conference Rooms
- Reception areas

FITTING COLOUR OPTION

- Satin Nickel (S9065SN/RING)

DIMENSIONS

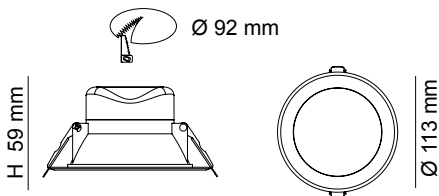

Model No.	Input	Power	Lumen	CCT	CRI	Beam Angle	Dimmable	Fitting Colour
S9065WW WH	240V	10W	800lm	3000K	>80	90°	Yes	White
S9065CW WH	240V	10W	850lm	4000K	>80	90°	Yes	White
S9065DL WH	240V	10W	900lm	6000K	>80	90°	Yes	White

PHOTOMETRIC DATA

Unit: cd

S9065 WW

C0/C180 ————
C90/C270 ————

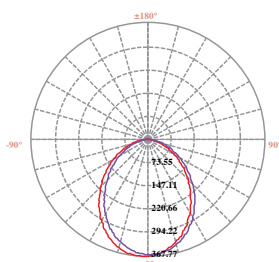

S9065DL

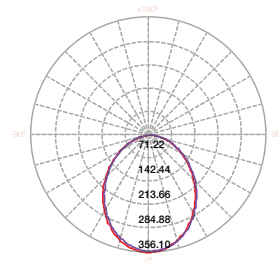

DIMMABLE LED DOWNLIGHT

S9066 WAVE

CONSTRUCTION

- Poly covered aluminium body
- Opal acrylic diffuser
- Double insulation
- High efficiency SMD LED chips
- Built-in trailing edge dimmable LED driver
- 1.2 m flex & plug fitted
- Integrated design, easy installation

IP RATING

- IP44 weatherproof

APPLICATIONS

- Residential
- Hotels
- Shops
- Conference Rooms
- Reception areas

DIMENSIONS

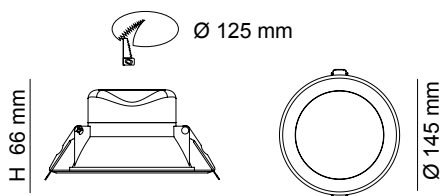

Model No.	Input	Power	Lumen	CCT	CRI	Beam Angle	Dimmable	Fitting Colour
S9066WW WH	240V	14W	1000lm	3000K	>80	90°	Yes	White
S9066CW WH	240V	14W	1150lm	4000K	>80	90°	Yes	White
S9066DL WH	240V	14W	1250lm	6000K	>80	90°	Yes	White

PHOTOMETRIC DATA

Unit: cd

S9066DL

C0/C180 ——— (Red line)
C90/C270 ——— (Blue line)

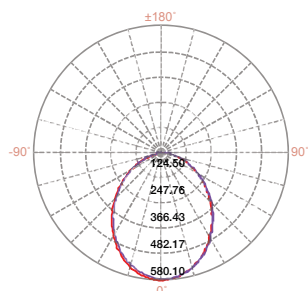



DIMMABLE LED DOWNLIGHT COLOUR TEMPERATURE CHANGEABLE S9865 TRI-WAVE

ICF
ABUTTED &
COVERED



5000K TO 2700K



COLOUR TEMPERATURE CHANGEABLE BETWEEN 5000K TO 2700K

COLOUR TEMPERATURE & LIGHT OUTPUT WITH POWER CHANGE

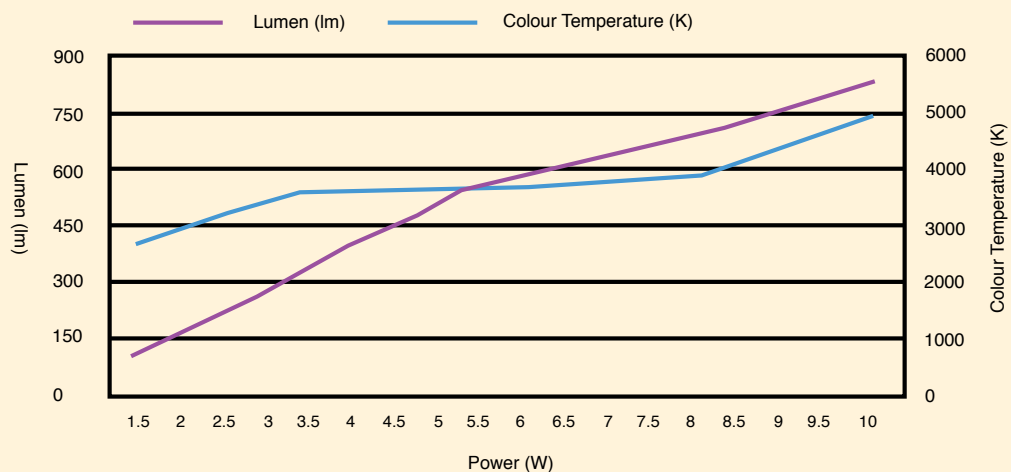

DIMMABLE LED DOWNLIGHT COLOUR TEMPERATURE CHANGEABLE

WITHOUT DIMMER

The default colour temperature is 5000K and lumen output is 850lm.

WITH A STANDARD ROTARY TRAILING EDGE DIMMER FROM MAXIMUM TO MIDWAY OF DIMMER POSITION

The primary effect is a reduction in the colour temperature from 5000K (daylight) to 3500K (warm white), with minimal reduction in light output (from 850lm to 600lm).

FROM MIDWAY TO MINIMUM OF DIMMER POSITION

The primary effect is a reduction in light output (from 600lm to 100lm) with slight further warming of the colour temperature to 2700K.

CONSTRUCTION

- Poly covered aluminium body
- Opal acrylic diffuser
- High efficiency SMD LED chips
- Built-in trailing edge dimmable LED driver
- 1.2 m flex & plug fitted
- Integrated design, easy installation

IP RATING

- IP44 weatherproof

DIMENSIONS

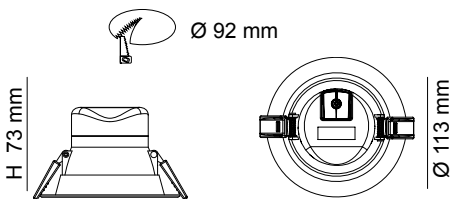

APPLICATIONS

- Residential
- Hotels
- Restaurants
- Conference Rooms

FITTING COLOUR OPTION

- Satin Nickel (S9065SN/RING)



Model No.	Input	Power	Lumen	CCT	CRI	Beam Angle	Dimmable	Fitting Colour
S9865WH	240V	10W	850lm	2700K - 5000K	>80	90°	Yes	White

316L STAINLESS STEEL RECESSED LED DOWNLIGHT KIT

S9081, S9083 EXCEL

CONSTRUCTION

- Machined 316L grade stainless steel casing
- Aluminium heat sink
- High efficiency SMD LED chips
- Polycarbonate optical lens
- S9081 fixed head or S9083 gimble 45° head
- Trailing edge dimmable LED driver
- 1.2 m flex & plug

IP RATING

- IP20 suitable for indoor use only

AVAILABLE COLOUR TEMPERATURE

- 5500K DAYLIGHT

DIMENSIONS

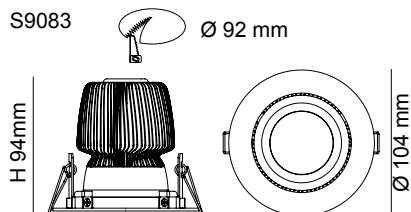
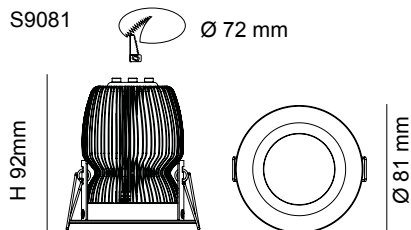

Model No.	Input	Power	Lumen	CCT	CRI	Beam Angle	Dimmable	Fitting Colour
S9081 DP SLS	240V	21W	1100lm	5500K	>80	40°	Yes	Stainless Steel
S9083 DP SLS	240V	21W	1100lm	5500K	>80	40°	Yes	Stainless Steel

PHOTOMETRIC DATA

Unit: cd

S9081, S9083 DL C0/C180 ————
C90/C270 ————

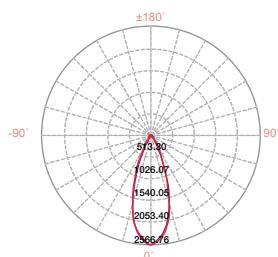

www.sal.net.au

DIMMABLE LED DOWNLIGHT

S9045 ECOSTAR

CONSTRUCTION

- Die-cast aluminium body
- Powder coated or plated finish
- High efficiency COB LED chip
- Multi-reflector system with polycarbonate lens
- Trailing edge dimmable LED driver included
- 1.2 m flex & plug fitted

IP RATING

- IP20 suitable for indoor use only

DIMMING OPTIONS

- 1-10V dimming
- Digital dimming (DSI, DALI)

APPLICATIONS

- Residential
- Hotels
- Shops
- Conference Rooms
- Reception areas

BEAM ANGLE OPTIONS

- 40° beam angle reflector



DIMENSIONS

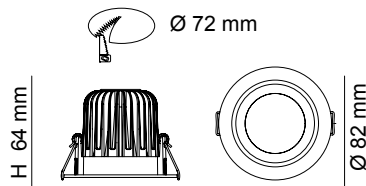

Model No.	Input	Power	Lumen	CCT	CRI	Beam Angle	Dimmable	Fitting Colour
S9045 WW WH	240V	9W	700lm	3000K	>82	60°	Yes	White
S9045 DL WH	240V	9W	800lm	6000K	>80	60°	Yes	White
S9045 WW SN	240V	9W	700lm	3000K	>82	60°	Yes	Satin Nickel
S9045 DL SN	240V	9W	800lm	6000K	>80	60°	Yes	Satin Nickel

PHOTOMETRIC DATA

Unit: cd

S9045 WW

C0/C180 ————
C90/C270 ————

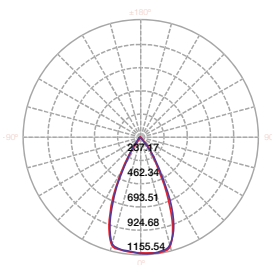

S9045 DL

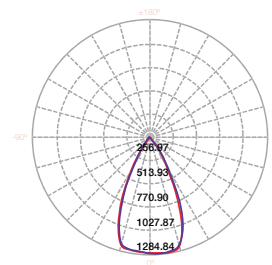

DIMMABLE LED DOWNLIGHT

S9046 ECOSTAR

CONSTRUCTION

- Die-cast aluminium body
- Powder coated or plated finish
- Gimble head
- High efficiency COB LED chip
- Multi-reflector system with polycarbonate lens
- Trailing edge dimmable LED driver included
- 1.2 m flex & plug fitted

IP RATING

- IP20 suitable for indoor use only

DIMMING OPTIONS

- 1-10V dimming
- Digital dimming (DSI, DALI)

APPLICATIONS

- Residential
- Hotels
- Shops
- Conference Rooms
- Reception areas

BEAM ANGLE OPTIONS

- 40° beam angle reflector



DIMENSIONS

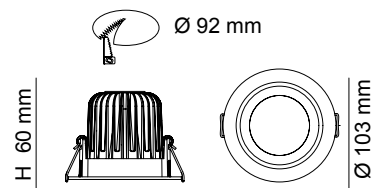

Model No.	Input	Power	Lumen	CCT	CRI	Beam Angle	Dimmable	Fitting Colour
S9046 WW WH	240V	9W	800lm	3000K	>82	60°	Yes	White
S9046 DL WH	240V	9W	850lm	6000K	>80	60°	Yes	White
S9046 WW SN	240V	9W	800lm	3000K	>82	60°	Yes	Satin Nickel
S9046 DL SN	240V	9W	850lm	6000K	>80	60°	Yes	Satin Nickel

PHOTOMETRIC DATA

Unit: cd

S9046 WW

C0/C180 ———
C90/C270 ———

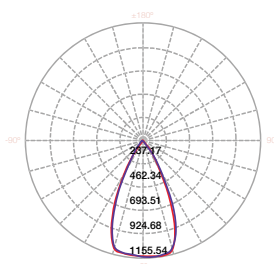

S9046 DL

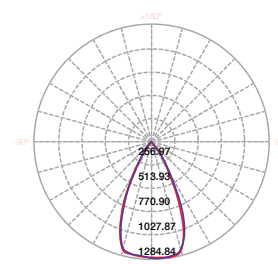

www.sal.net.au

DIMMABLE LED DOWNLIGHT

S9048 ECOSTAR

CONSTRUCTION

- Die-cast aluminium body
- Powder coated or plated finish
- High efficiency COB LED chip
- Multi-reflector system with polycarbonate lens
- Trailing edge dimmable LED driver included
- 1.2 m flex & plug fitted

IP RATING

- IP44 weatherproof

APPLICATIONS

- Residential
- Hotels
- Shops
- Conference Rooms
- Reception areas



DIMENSIONS

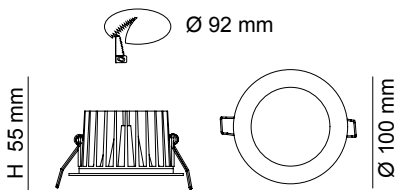

Model No.	Input	Power	Lumen	CCT	CRI	Beam Angle	Dimmable	Fitting Colour
S9048 WW WH	240V	12W	750lm	3000K	>80	55°	Yes	White
S9048 DL WH	240V	12W	800lm	5000K	>80	55°	Yes	White
S9048 WW SN	240V	12W	750lm	3000K	>80	55°	Yes	Satin Nickel
S9048 DL SN	240V	12W	800lm	5000K	>80	55°	Yes	Satin Nickel

PHOTOMETRIC DATA

Unit: cd

S9048 WW

C0/C180 ————
C90/C270 ————

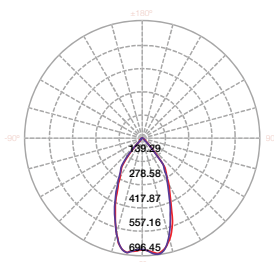

S9048 DL

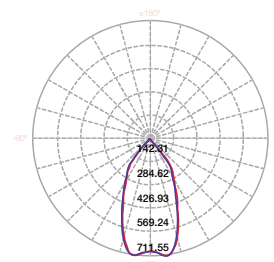

DIMMABLE LED DOWNLIGHT

S9045SM SM-ECOSTAR

CONSTRUCTION

- Extruded aluminium surface mount casing
- Powder coated finish
- S9045 LED downlight kit included

IP RATING

- IP44 weatherproof

DIMMING OPTIONS

- 1-10V dimming
- Digital dimming (DSI, DALI)

APPLICATIONS

- Residential
- Hotels
- Shops
- Conference Rooms
- Reception areas

BEAM ANGLE OPTIONS

- 40° beam angle reflector



DIMENSIONS

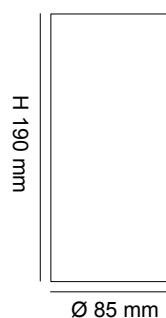

Model No.	Input	Power	Lumen	CCT	CRI	Beam Angle	Dimmable	Fitting Colour
S9045SM/C WW WH	240V	9W	700lm	3000K	>80	60°	Yes	White
S9045SM/C DL WH	240V	9W	800lm	6000K	>80	60°	Yes	White

PHOTOMETRIC DATA

Unit: cd

S9045 WW

C0/C180 ———
C90/C270 ———

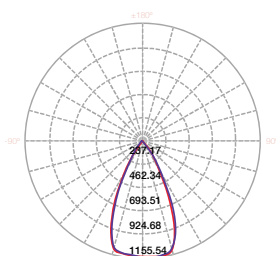

S9045 DL

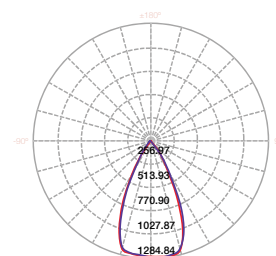

DIMMABLE LED DOWNLIGHT

S9046SM, S9048SM SM-ECOSTAR

CONSTRUCTION

- Pressed metal surface mount casing
- Powder coated finish
- Trailing edge dimmable LED downlight kit included

IP RATING

- IP20 suitable for indoor use only

DIMMING OPTIONS (S9046SM)

- 1-10V dimming
- Digital dimming (DSI, DALI)

APPLICATIONS

- Residential
- Hotels
- Shops
- Conference Rooms
- Reception areas

DIMENSIONS

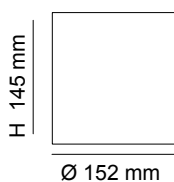

Model No.	Input	Power	Lumen	CCT	CRI	Beam Angle	Dimmable	Fitting Colour
S9046SM/C WW WH	240V	9W	800lm	3000K	>80	60°	Yes	White
S9046SM/C DL WH	240V	9W	850lm	6000K	>80	60°	Yes	White

Model No.	Input	Power	Lumen	CCT	CRI	Beam Angle	Dimmable	Fitting Colour
S9048SM/C WW WH	240V	12W	750lm	3000K	>80	55°	Yes	White
S9048SM/C DL WH	240V	12W	800lm	5000K	>80	55°	Yes	White

PHOTOMETRIC DATA

Please refer to S9046, S9048

IP64 LED DOWNLIGHT

S9071, S9072, S9073 PREMIER

ICF
ABUTTED &
COVERED



CONSTRUCTION

- Premium grade aluminium body
- Anodized silver or powder coated finish
- Opal acrylic diffuser
- High efficiency SMD LED chips
- Trailing edge dimmable LED driver included
- 1.2 m flex & plug fitted

APPLICATIONS

- Residential
- Hotels
- Shops
- Conference Rooms
- Reception areas

IP RATING

- IP64 weatherproof

DIMMING OPTIONS

- 1-10V dimming
- Digital dimming (DSI, DALI)

DIMENSIONS

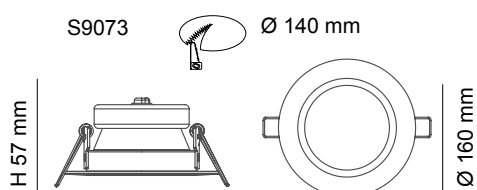
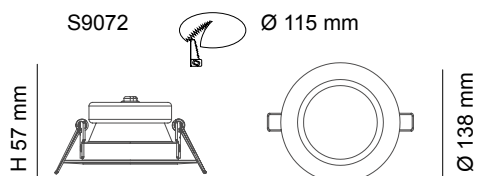
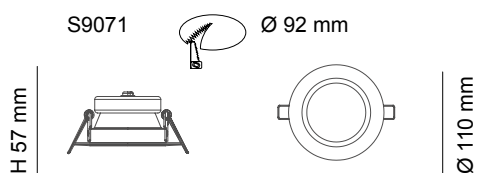



Model No.	Input	Power	Lumen	CCT	CRI	Beam Angle	Dimmable	Fitting Colour
S9071WP WH	240V	11W	800lm	3000K	>80	90°	Yes	White
S9071CP WH	240V	11W	880lm	4000K	>80	90°	Yes	White
S9071DP WH	240V	11W	900lm	6000K	>80	90°	Yes	White
S9071WP SL	240V	11W	800lm	3000K	>80	90°	Yes	Anodized Silver
S9071CP SL	240V	11W	880lm	4000K	>80	90°	Yes	Anodized Silver
S9071DP SL	240V	11W	900lm	6000K	>80	90°	Yes	Anodized Silver

Model No.	Input	Power	Lumen	CCT	CRI	Beam Angle	Dimmable	Fitting Colour
S9072WP WH	240V	14W	1000lm	3000K	>80	90°	Yes	White
S9072CP WH	240V	14W	1100lm	4000K	>80	90°	Yes	White
S9072DP WH	240V	14W	1150lm	6000K	>80	90°	Yes	White
S9072WP SL	240V	14W	1000lm	3000K	>80	90°	Yes	Anodized Silver
S9072DP SL	240V	14W	1150lm	6000K	>80	90°	Yes	Anodized Silver

Model No.	Input	Power	Lumen	CCT	CRI	Beam Angle	Dimmable	Fitting Colour
S9073 WP WH	240V	18W	1400lm	3000K	>80	90°	Yes	White
S9073 CP WH	240V	18W	1500lm	4000K	>80	90°	Yes	White
S9073 DP WH	240V	18W	1550lm	6000K	>80	90°	Yes	White
S9073 WP SL	240V	18W	1400lm	3000K	>80	90°	Yes	Anodized Silver
S9073 DP SL	240V	18W	1550lm	6000K	>80	90°	Yes	Anodized Silver

PHOTOMETRIC DATA

Unit: cd

S9071 WP C0/C180 ———
C90/C270 ———

S9072 WP

S9073 WP

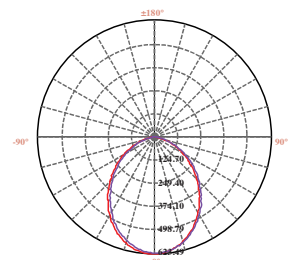
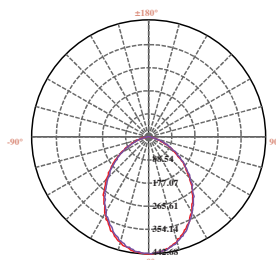
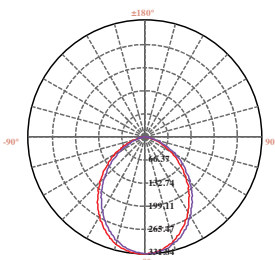

IP64 LED DOWNLIGHT

S9074, S9075, S9076 PREMIER

ICF
ABUTTED &
COVERED



CONSTRUCTION

- Premium grade aluminium body
- Powder coated finish
- Opal acrylic diffuser
- High efficiency SMD LED chips
- Constant current LED driver included
- 1.2 m flex & plug fitted

APPLICATIONS

- Residential
- Hotels
- Shops
- Conference Rooms
- Reception areas

DIMENSIONS

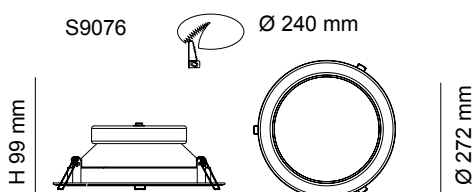
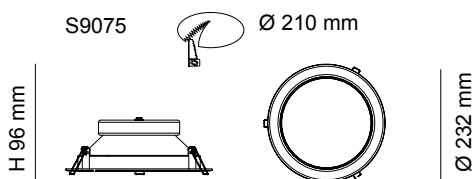
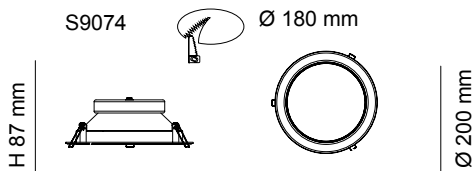

DIMMING OPTIONS

- Trailing edge dimming (S9074 & S9075)
- 1-10V dimming
- Digital dimming (DSI, DALI)

IP RATING

- IP64 weatherproof



Model No.	Input	Power	Lumen	CCT	CRI	Beam Angle	Dimmable	Fitting Colour
S9074WP WH	240V	21W	1600lm	3000K	>80	90°	No	White
S9074CP WH	240V	21W	1700lm	4000K	>80	90°	No	White
S9074DP WH	240V	21W	1800lm	6000K	>80	90°	No	White

Model No.	Input	Power	Lumen	CCT	CRI	Beam Angle	Dimmable	Fitting Colour
S9075WP WH	240V	31W	2500lm	3000K	>80	90°	No	White
S9075CP WH	240V	31W	2650lm	4000K	>80	90°	No	White
S9075DP WH	240V	31W	2800lm	6000K	>80	90°	No	White

Model No.	Input	Power	Lumen	CCT	CRI	Beam Angle	Dimmable	Fitting Colour
S9076WP WH	240V	40W	3200lm	3000K	>80	90°	No	White
S9076CP WH	240V	40W	3350lm	4000K	>80	90°	No	White
S9076DP WH	240V	40W	3500lm	6000K	>80	90°	No	White

PHOTOMETRIC DATA

Unit: cd

S9074 WP C0/C180 ————
C90/C270 ————

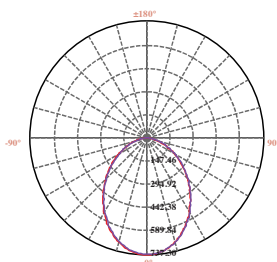

S9075 WP

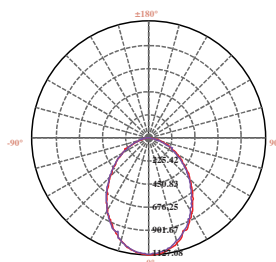

S9076 WP

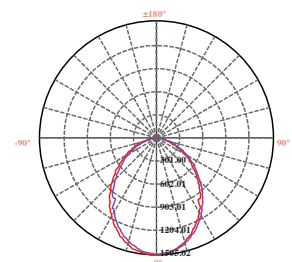

LED SHOP LIGHT

S9514 ALBANY

CONSTRUCTION

- Die-cast aluminium body
- Powder coated finish
- Opal polycarbonate diffuser
- High efficiency SMD LED chips
- Constant current LED driver included
- 1.2 m flex & plug fitted

IP RATING

- IP20 suitable for indoor use only

APPLICATIONS

- Hotels
- Shops
- Conference Rooms
- Reception areas

DIMMING OPTIONS

- Analogue dimming (Trailing edge, 1-10V dimming)
- Digital dimming (DSI, DALI)

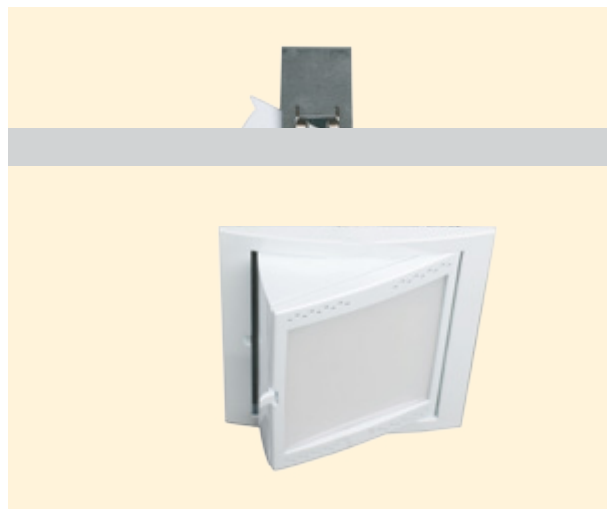

DIMENSIONS

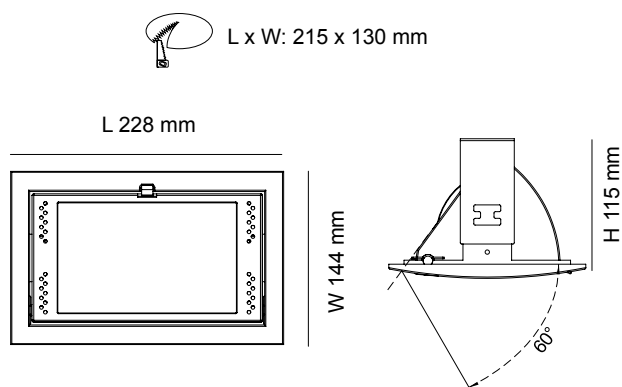

Model No.	Input	Power	Lumen	CCT	CRI	Beam Angle	Dimmable	Fitting Colour
S9514 WW WH	240V	38W	3500lm	3000K	>82	100°	No	White
S9514 DL WH	240V	38W	3600lm	5500K	>80	100°	No	White
S9514 WW SL	240V	38W	3500lm	3000K	>82	100°	No	Silver
S9514 DL SL	240V	38W	3600lm	5500K	>80	100°	No	Silver

PHOTOMETRIC DATA

Unit: cd

S9514WW

C0/C180 ————
C90/C270 ————

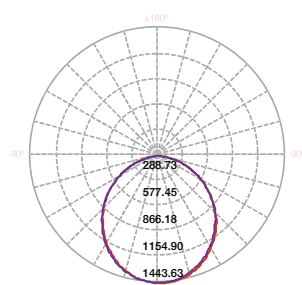

S9514DL

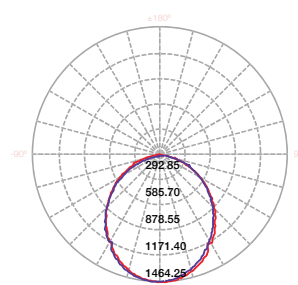

LED SHOP LIGHT S9522 EXMOUTH

CONSTRUCTION

- Die-cast aluminium body
- Powder coated finish
- Opal polycarbonate diffuser
- High efficiency SMD LED chips
- Constant current LED driver included
- 1.2 m flex & plug fitted

IP RATING

- IP20 suitable for indoor use only

APPLICATIONS

- Hotels
- Shops
- Conference Rooms
- Reception areas

DIMMING OPTIONS

- Analogue dimming (Trailing edge, 1-10V dimming)
- Digital dimming (DSI, DALI)



DIMENSIONS

S9522  Ø 160 mm

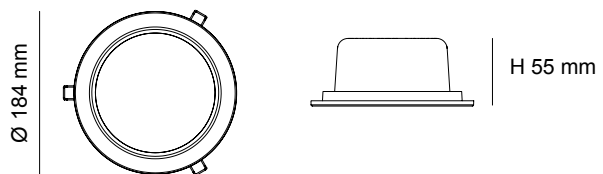



Model No.	Input	Power	Lumen	CCT	CRI	Beam Angle	Dimmable	Fitting Colour
S9522 WW WH	240V	22W	1900lm	3000K	>82	105°	No	White
S9522 DL WH	240V	22W	2200lm	5500K	>80	105°	No	White
S9522 WW SL	240V	22W	1900lm	3000K	>82	105°	No	Silver
S9522 DL SL	240V	22W	2200lm	5500K	>80	105°	No	Silver

PHOTOMETRIC DATA

Unit: cd

S9522WW

C0/C180 
C90/C270 

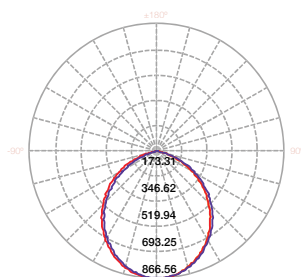

S9522DL

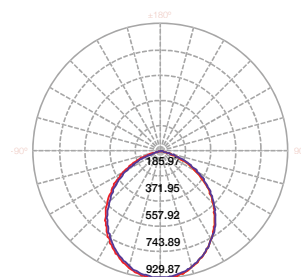

LED SHOP LIGHT

S9523 EXMOUTH

CONSTRUCTION

- Die-cast aluminium body
- Powder coated finish
- Opal polycarbonate diffuser
- High efficiency SMD LED chips
- Constant current LED driver included
- 1.2 m flex & plug fitted

IP RATING

- IP20 suitable for indoor use only

APPLICATIONS

- Hotels
- Shops
- Conference Rooms
- Reception areas

DIMMING OPTIONS

- Analogue dimming (Trailing edge, 1-10V dimming)
- Digital dimming (DSI, DALI)



DIMENSIONS

S9523  Ø 195 mm

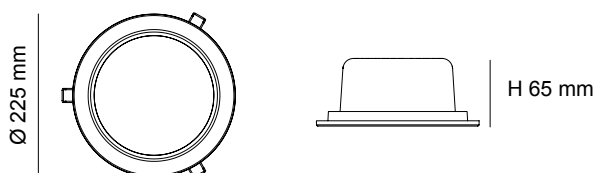



Model No.	Input	Power	Lumen	CCT	CRI	Beam Angle	Dimmable	Fitting Colour
S9523 WW WH	240V	38W	3800lm	3000K	>82	105°	No	White
S9523 DL WH	240V	38W	3800lm	5500K	>80	105°	No	White
S9523 WW SL	240V	38W	3800lm	3000K	>82	105°	No	Silver
S9523 DL SL	240V	38W	3800lm	5500K	>80	105°	No	Silver

PHOTOMETRIC DATA

Unit: cd

S9523WW

C0/C180 
C90/C270 

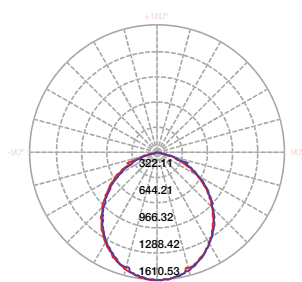

S9523DL

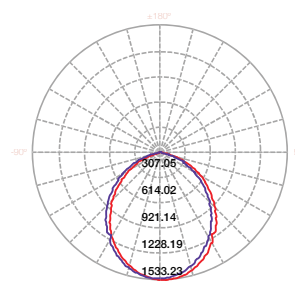

LED SHOP LIGHT

S9523SM SM-EXMOUTH

CONSTRUCTION

- Pressed steel casing
- Powder coated finish
- S9523 LED downlight kit included

IP RATING

- IP20 suitable for indoor use only

APPLICATIONS

- Hotels
- Shops
- Conference Rooms
- Reception areas

DIMMING OPTIONS

- Analogue dimming (Trailing edge, 1-10V dimming)
- Digital dimming (DSI, DALI)

DIMENSIONS

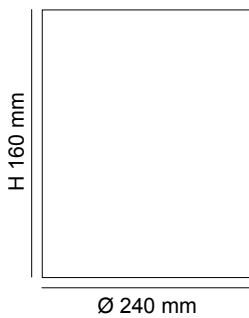

Model No.	Input	Power	Lumen	CCT	CRI	Beam Angle	Dimmable	Fitting Colour
S9523SM/C WW WH	240V	38W	3800lm	3000K	>82	105°	No	White
S9523SM/C DL WH	240V	38W	3800lm	5500K	>80	105°	No	White

PHOTOMETRIC DATA

Unit: cd

S9523WW

C0/C180 ———
C90/C270 ———

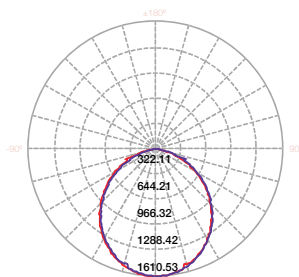

S9523DL

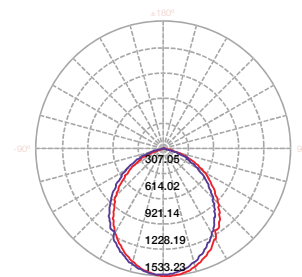

LED SHOP LIGHT

S9535 NEWMAN MKII

CONSTRUCTION

- Die-cast aluminium body
- Powder coated finish
- Textured glass diffuser
- High efficiency SMD LED chips
- 60° multi-reflector system
- Constant current LED driver included
- 1.2 m flex & plug fitted

IP RATING

- IP20 suitable for indoor use only

APPLICATIONS

- Shops
- Conference Rooms
- Reception areas

DIMMING OPTIONS

- Analogue dimming (Trailing edge, 1-10V dimming)
- Digital dimming (DSI, DALI)



DIMENSIONS

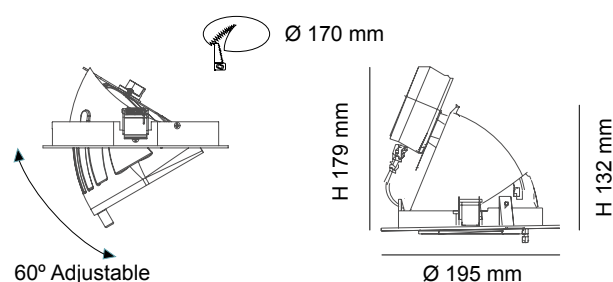

Model No.	Input	Power	Lumen	CCT	CRI	Beam Angle	Dimmable	Fitting Colour
S9535 WW WH	240V	28W	2600lm	3000K	>80	60°	No	White
S9535 CW WH	240V	28W	2700lm	4000K	>80	60°	No	White
S9535 DL WH	240V	28W	2800lm	5500K	>80	60°	No	White

PHOTOMETRIC DATA

Unit: cd

S9535 WW

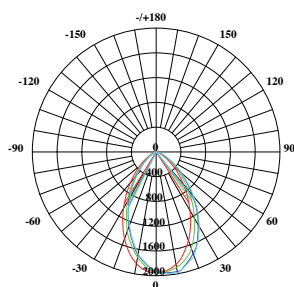

S9535 CW

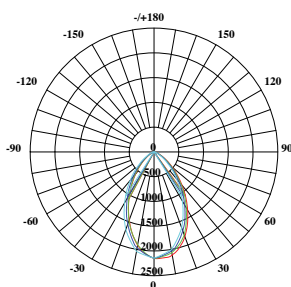

- C0/C180
- C60/240
- C30/210
- C90/270



LED SHOP LIGHT

S9545 NEWMAN MKII

CONSTRUCTION

- Die-cast aluminium body
- Powder coated finish
- Textured glass diffuser
- High efficiency SMD LED chips
- 60° multi-reflector system
- Constant current LED driver included
- 1.2 m flex & plug fitted

IP RATING

- IP20 suitable for indoor use only

APPLICATIONS

- Shops
- Conference Rooms
- Reception areas

DIMMING OPTIONS

- Analogue dimming (Trailing edge, 1-10V dimming)
- Digital dimming (DALI)



DIMENSIONS

Ø 170 mm

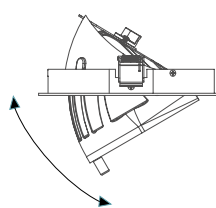

60° Adjustable

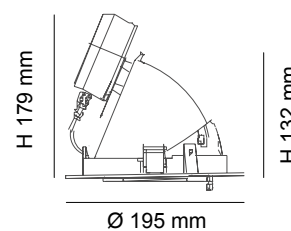

Model No.	Input	Power	Lumen	CCT	CRI	Beam Angle	Dimmable	Fitting Colour
S9545WW/WH	240V	38W	3600lm	3000K	>80	60°	No	White
S9545CW/WH	240V	38W	3700lm	4000K	>80	60°	No	White
S9545DL/WH	240V	38W	3800lm	5500K	>80	60°	No	White

PHOTOMETRIC DATA

Unit: cd

S9545WW

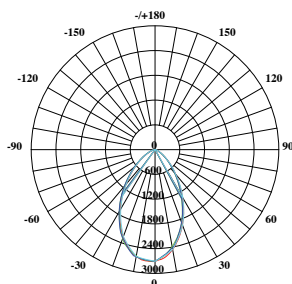

S9545CW

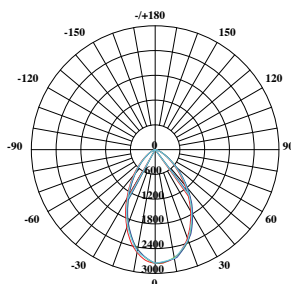

S9545DL

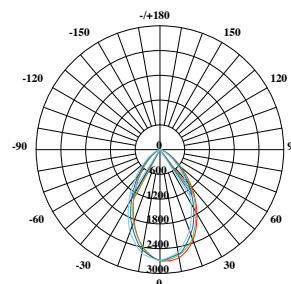

C0/C180 ————
 C60/240 ————
 C30/210 ————
 C90/270 ————

IP54 LED SHOP LIGHT

S9656, S9658 UNI LED



CONSTRUCTION

- Die-cast aluminium body
- Powder coated finish
- High efficiency COB LED chip
- Multi-reflector system
- Clear glass diffuser (Changeable)
- Constant current LED driver included
- 1.2 m flex & plug fitted

S9656 DIMMING OPTIONS

- Analogue dimming (Trailing edge, 1-10V)
- Digital dimming (DSI, DALI)

S9658 DIMMING OPTIONS

- Analogue dimming (1-10V)
- Digital dimming (DSI, DALI)

APPLICATIONS

- Hotels
- Shops
- Conference Rooms
- Reception areas

IP RATING

- IP54 weatherproof

DIMENSIONS (S9656)

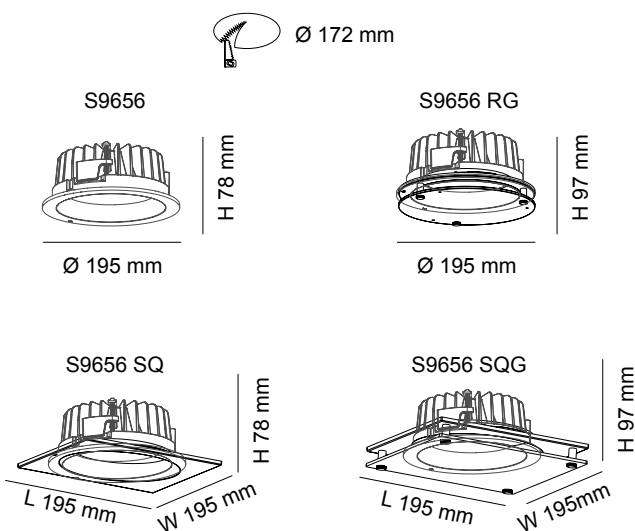

DIMENSIONS (S9658)

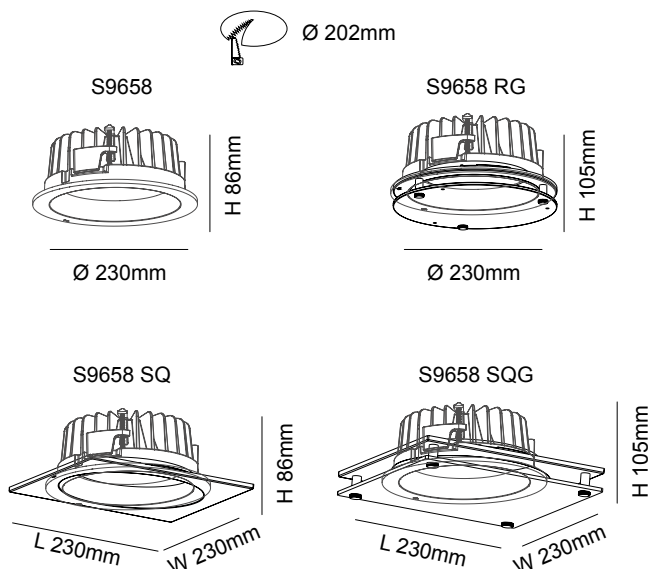

SQUARE FACE COVER

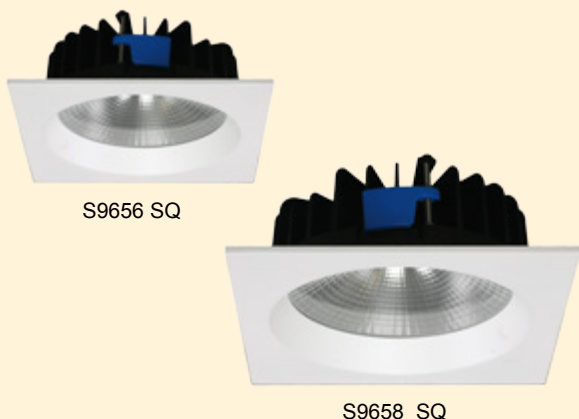

SQUARE FACE COVER WITH DROPPED GLASS



Model No.	Input	Power	Lumen	CCT	CRI	Beam Angle	Dimmable	Fitting Colour
S9656WW WH	240V	25W	2200lm	3000K	>80	90°	No	White
S9656WW WH SQ	240V	25W	2200lm	3000K	>80	90°	No	White
S9656WW BK	240V	25W	2200lm	3000K	>80	90°	No	Black
S9656WW BK SQ	240V	25W	2200lm	3000K	>80	90°	No	Black
S9656WW WH RG	240V	25W	2200lm	3000K	>80	90°	No	White
S9656WW WH SQG	240V	25W	2200lm	3000K	>80	90°	No	White

Model No.	Input	Power	Lumen	CCT	CRI	Beam Angle	Dimmable	Fitting Colour
S9656CW WH	240V	25W	2300lm	4000K	>80	90°	No	White
S9656CW WH SQ	240V	25W	2300lm	4000K	>80	90°	No	White
S9656CW BK	240V	25W	2300lm	4000K	>80	90°	No	Black
S9656CW BK SQ	240V	25W	2300lm	4000K	>80	90°	No	Black
S9656CW WH RG	240V	25W	2300lm	4000K	>80	90°	No	White
S9656CW WH SQG	240V	25W	2300lm	4000K	>80	90°	No	White

Model No.	Input	Power	Lumen	CCT	CRI	Beam Angle	Dimmable	Fitting Colour
S9658WW WH	240V	50W	4000lm	3000K	>80	90°	No	White
S9658WW WH SQ	240V	50W	4000lm	3000K	>80	90°	No	White
S9658WW BK	240V	50W	4000lm	3000K	>80	90°	No	Black
S9658WW BK SQ	240V	50W	4000lm	3000K	>80	90°	No	Black
S9658WW WH RG	240V	50W	4000lm	3000K	>80	90°	No	White
S9658WW WH SQG	240V	50W	4000lm	3000K	>80	90°	No	White

Model No.	Input	Power	Lumen	CCT	CRI	Beam Angle	Dimmable	Fitting Colour
S9658CW WH	240V	50W	4200lm	4000K	>80	90°	No	White
S9658CW WH SQ	240V	50W	4200lm	4000K	>80	90°	No	White
S9658CW BK	240V	50W	4200lm	4000K	>80	90°	No	Black
S9658CW BK SQ	240V	50W	4200lm	4000K	>80	90°	No	Black
S9658CW WH RG	240V	50W	4200lm	4000K	>80	90°	No	White
S9658CW WH SQG	240V	50W	4200lm	4000K	>80	90°	No	White

PHOTOMETRIC DATA

Unit: cd

S9656 WW C0/C180 ———
C90/C270 ———

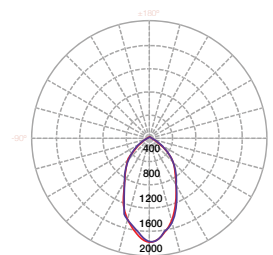

S9658 WW C0/C180 ———
C90/C270 ———

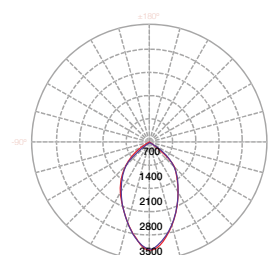

LED SHOP LIGHT

S9520 SEYMOUR, S9530 MANSFIELD

DIMENSIONS

S9520/700

S9520/1700

 L x W: 165 x 165 mm

H 164 mm

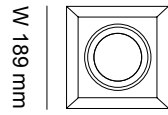
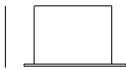

W 189 mm

L 189 mm



S9520/700, S9520/1700, S9530/1700, S9530/3500

S9530/1700

S9530/3500

 L x W: 165 x 165 mm

H 178 mm

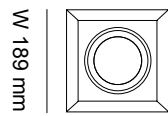
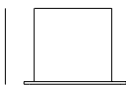

W 189 mm

L 189 mm



S9520/2 x 700, S9520/2x1700, S9530/2 x 1700, S9530/2x3500

S9520/2 x 700

S9520/2 x 1700

 L x W: 335 x 165 mm

H 164 mm

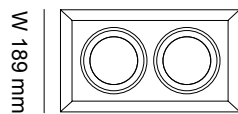
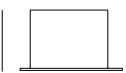

W 189 mm

L 361 mm

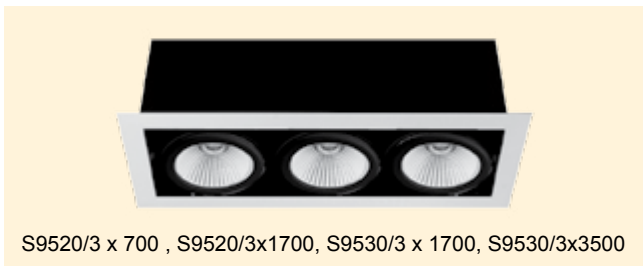

S9520/3 x 700, S9520/3x1700, S9530/3 x 1700, S9530/3x3500

S9530/2 x 1700

S9530/2 x 3500

 L x W: 335 x 165 mm

H 178 mm

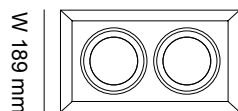

W 189 mm

L 361 mm

PHOTOMETRIC DATA

Unit:cd

S9520/1700 B.A.24°

C0/C180

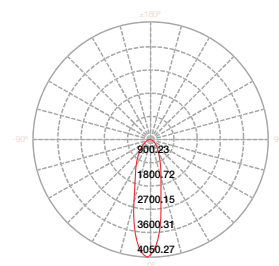

S9520/3 x 700

S9520/3 x 1700

 L x W: 480 x 165 mm

H 164 mm

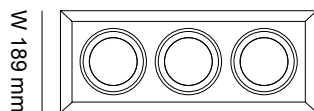

W 189 mm

L 513 mm

S9530/3 x 1700

S9530/3 x 3500

 L x W: 480 x 165 mm

H 178 mm

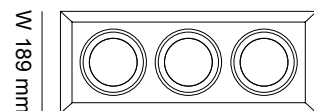

W 189 mm

L 513 mm



www.sal.net.au

CONSTRUCTION

- Pressed steel casing
- Powder coated finish
- LED AR111 module(s) & driver(s) included
- High efficiency COB LED chip
- Specially designed optical lens
- Changeable multi-reflector system
- Transformer or LED driver(s) included
- 1.2 m flex & plug fitted
- 40° – Beam angle option (AR111/700, AR111/1700)
- 20° / 60° – Beam angle option (AR111/3500)

IP RATING

- IP20 suitable for indoor use only

APPLICATIONS

- Offices
- Conference Rooms
- Reception areas

DIMMING OPTIONS (AR111/1700, AR111/3500)

- 1-10V dimming
- Digital dimming (DSI, DALI)



Model No.	Input	Power	Lumen	CCT	CRI	Beam Angle	Fitting Colour	Dimensions L x W x H	Cut out size L x W	Dimmable
S9520/700 WH	240V	12W	750lm	3000K	>80	24°	White	189 x 189 x 164	165 x 165	Yes
S9520/700 SL	240V	12W	750lm	3000K	>80	24°	Silver	189 x 189 x 164	165 x 165	Yes
S9520/2x700 WH	240V	24W	1500lm	3000K	>80	24°	White	361 x 189 x 164	360 x 165	Yes
S9520/2x700 SL	240V	24W	1500lm	3000K	>80	24°	Silver	361 x 189 x 164	360 x 165	Yes
S9520/3x700 WH	240V	36W	2250lm	3000K	>80	24°	White	513 x 189 x 164	480 x 165	Yes
S9520/3x700 SL	240V	36W	2250lm	3000K	>80	24°	Silver	513 x 189 x 164	480 x 165	Yes
S9520/1700 WH	240V	20W	1600lm	3000K	>80	24°	White	189 x 189 x 164	165 x 165	Yes
S9520/1700 SL	240V	20W	1600lm	3000K	>80	24°	Silver	189 x 189 x 164	165 x 165	Yes
S9520/2x1700 WH	240V	40W	3200lm	3000K	>80	24°	White	361 x 189 x 164	360 x 165	Yes
S9520/2x1700 SL	240V	40W	3200lm	3000K	>80	24°	Silver	361 x 189 x 164	360 x 165	Yes
S9520/3x1700 WH	240V	60W	4800lm	3000K	>80	24°	White	513 x 189 x 164	480 x 165	Yes
S9520/3x1700 SL	240V	60W	4800lm	3000K	>80	24°	Silver	513 x 189 x 164	480 x 165	Yes

Model No.	Input	Power	Lumen	CCT	CRI	Beam Angle	Fitting Colour	Dimensions L x W x H	Cut out size L x W	Dimmable
S9530/1700 WH	240V	20W	1600lm	3000K	>80	24°	White	189 x 189 x 178	165 x 165	Yes
S9530/1700 SL	240V	20W	1600lm	3000K	>80	24°	Silver	189 x 189 x 178	165 x 165	Yes
S9530/2x1700 WH	240V	40W	3200lm	3000K	>80	24°	White	361 x 189 x 178	360 x 165	Yes
S9530/2x1700 SL	240V	40W	3200lm	3000K	>80	24°	Silver	361 x 189 x 178	360 x 165	Yes
S9530/3x1700 WH	240V	60W	4800lm	3000K	>80	24°	White	513 x 189 x 178	480 x 165	Yes
S9530/3x1700 SL	240V	60W	4800lm	3000K	>80	24°	Silver	513 x 189 x 178	480 x 165	Yes
S9530/3500 WH	240V	35W	3300lm	3000K	>80	40°	White	189 x 189 x 178	165 x 165	No
S9530/3500 SL	240V	35W	3300lm	3000K	>80	40°	Silver	189 x 189 x 178	165 x 165	No
S9530/2x3500 WH	240V	70W	6600lm	3000K	>80	40°	White	361 x 189 x 178	360 x 165	No
S9530/2x3500 SL	240V	70W	6600lm	3000K	>80	40°	Silver	361 x 189 x 178	360 x 165	No
S9530/3x3500 WH	240V	105W	9900lm	3000K	>80	40°	White	513 x 189 x 178	480 x 165	No
S9530/3x3500 SL	240V	105W	9900lm	3000K	>80	40°	Silver	513 x 189 x 178	480 x 165	No



ARCHITECTURAL LED DOWNLIGHT

L21022, L21021, L21012, L21011 EUROPA

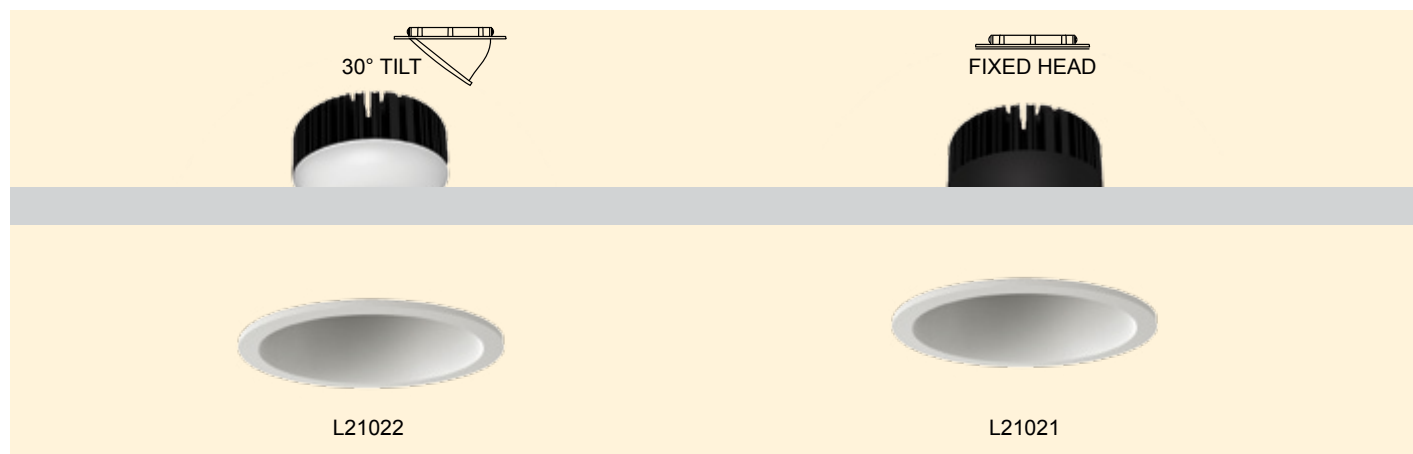

CONSTRUCTION

- Die-cast aluminium body
- Powder coated finish
- High efficiency COB LED chip
- Multi-reflector system
- Trailing edge dimmable LED driver included
- 1.2 m flex & plug fitted

APPLICATIONS

- Residential
- Hotels
- Shops
- Conference Rooms
- Reception areas

DIMMING OPTIONS

- 1-10V dimming
- Digital dimming (DSI, DALI)

IP RATING

- IP20 suitable for indoor use only

Model No.	Input	Power	Lumen	CCT	CRI	Beam Angle	Dimmable	Fitting Colour
L21022 WW WH	240V	10W	700lm	3000K	>85	60°	Yes	Matt White
L21021 WW WH	240V	10W	700lm	3000K	>85	60°	Yes	Matt White
L21012 WW WH	240V	9W	500lm	3000K	>85	40°	Yes	Matt White
L21011 WW WH	240V	9W	500lm	3000K	>85	40°	Yes	Matt White

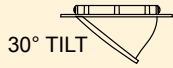

L21012



L21011

DIMENSIONS

L21022 Ø 88 mm

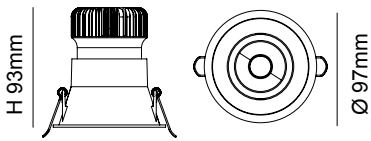

L21021 Ø 88 mm

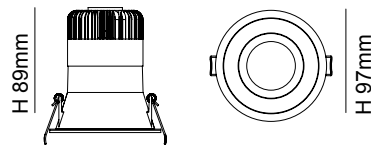

L21012 Ø 75 mm

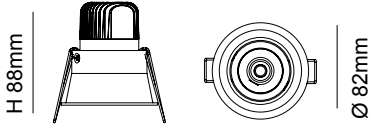

L21011 Ø 75 mm

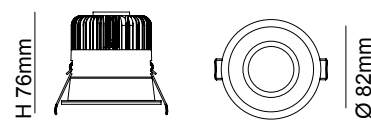

PHOTOMETRIC DATA

Unit: cd

C0/C180

C90/C270

L21022, L21021

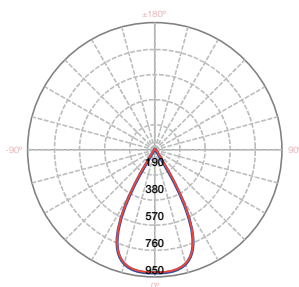

L21012, L21011

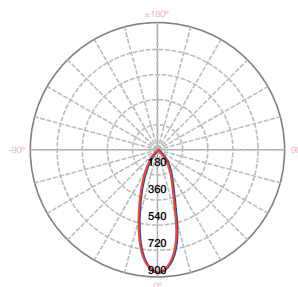

DIMMABLE DOWNLIGHT LED MODULE

S9053 UNIFIT

- Die-cast aluminium heat sink
- High efficiency COB LED chip
- Changeable multi-reflector system
- 60° standard beam angle
- Polycarbonate optical lens
- Trailing edge dimmable LED driver included
- 1.2 m flex & plug fitted

IP RATING

- IP20 suitable for indoor use only

BEAM ANGLE OPTIONS

- S9053R25/P - 25° optical reflector
- S9053R40/P - 40° optical reflector

DIMMING OPTIONS

- 1-10V dimming
- Digital dimming (DSI, DALI)

ACCESSORY OPTIONS

- S9053HC/P Honey comb
- S9053DF/P Centre frost diffuser
- S9053BF/P Buffer



Model No.	Input	Power	Lumen	CCT	CRI	Beam Angle	Dimmable
S9053 WP	240V	9W	700lm	3000K	>82	60°	Yes
S9053 DP	240V	9W	800lm	6000K	>80	60°	Yes

PHOTOMETRIC DATA

Unit: cd

S9053 WP

C0/C180 ———
C90/C270 ———

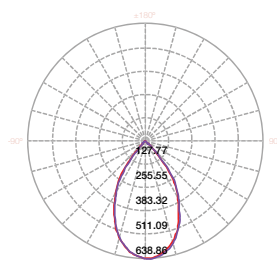

S9053 DP

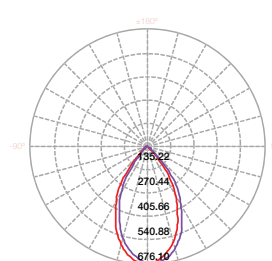

DIMENSIONS

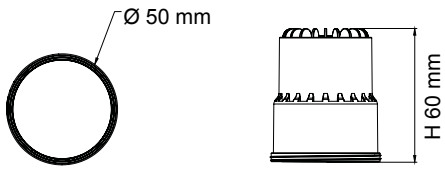

EXPLOSION VIEW

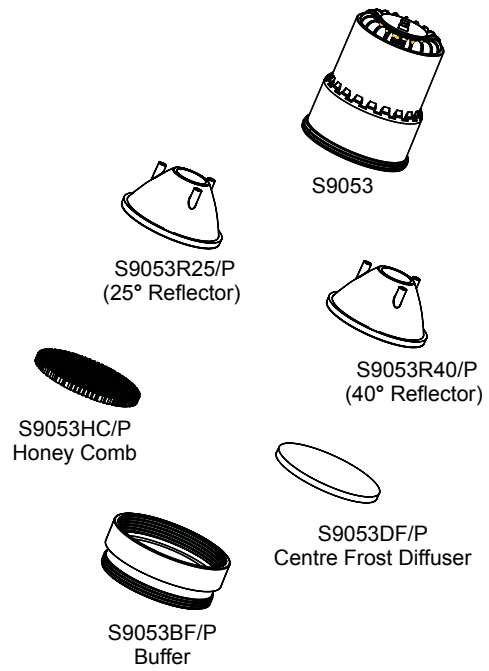

SUITABLE FITTINGS

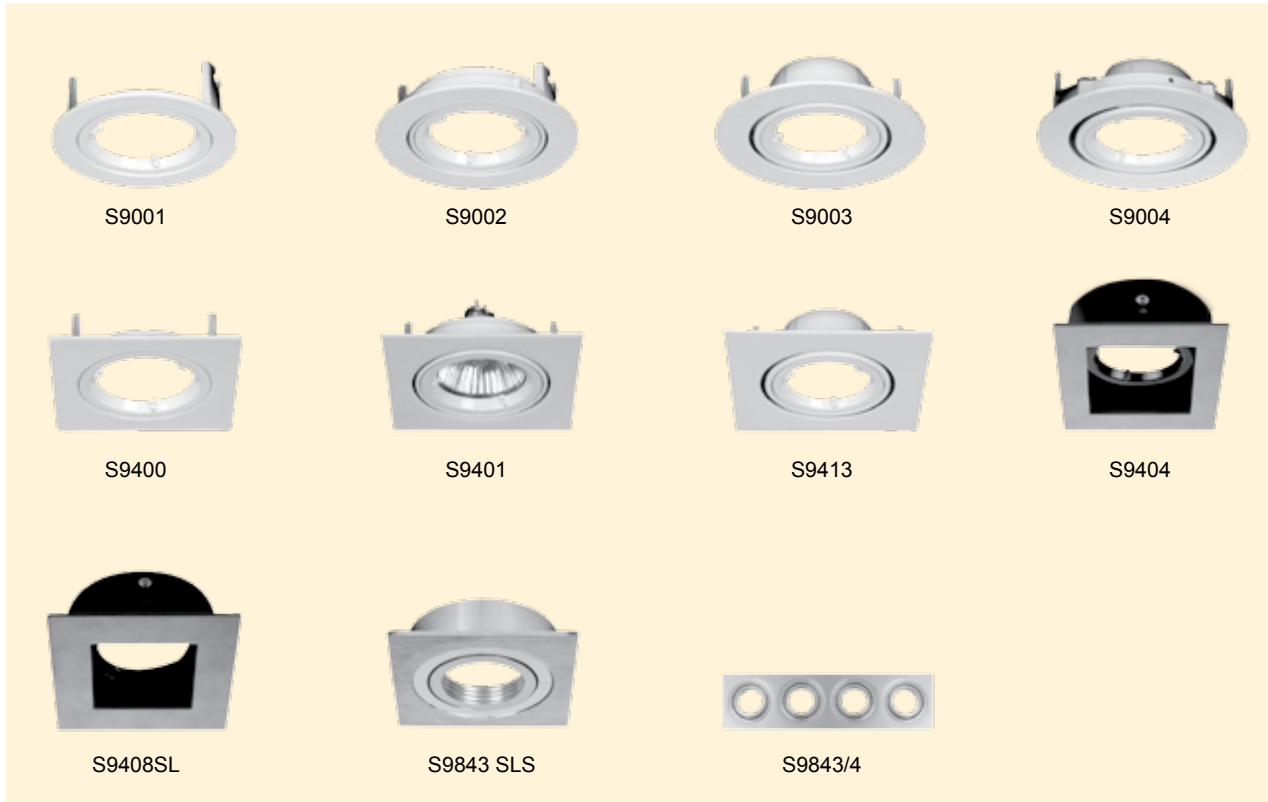

FIRE RATED LED DOWNLIGHT

S9902F-S9053 FIREFOX

CONSTRUCTION

- Steel canister with anti-fire insulation
- Robust constructions, powder coated finish
- Fire rated: 120 mins
- Compliant with Australian standard AS1530.4
- S9053 LED downlight kit fitted

IP RATING

- IP20 suitable for indoor use only

DIMMING OPTIONS

- 1-10V dimming
- Digital dimming (DSI, DALI)

APPLICATIONS

- Residential
- Hotels
- Shops
- Conference Rooms
- Reception areas



Model No.	Input	Power	Lumen	CCT	CRI	Beam Angle	Dimmable	Fitting Colour
S9902F/120-S9053 WP	240V	9W	700lm	3000K	>82	60°	Yes	White
S9902F/120-S9053 DP	240V	9W	800lm	6000K	>80	60°	Yes	White

DIMENSIONS

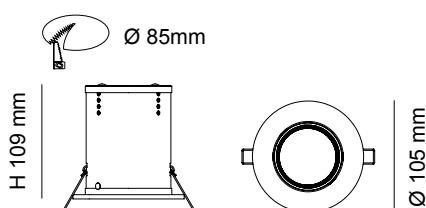

In the event of ceiling fire, the rise in temperature causes the insulation in the can to expand and thus closes the ventilation holes, preventing the spread of fire from ceiling to room.

PHOTOMETRIC DATA

Unit: cd

S9902F-S9053 WP

C0/C180 ———
C90/C270 ———

S9902F-S9053 DP

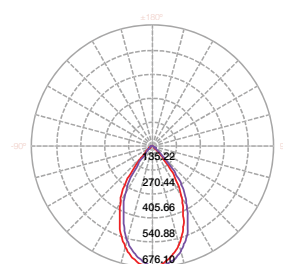
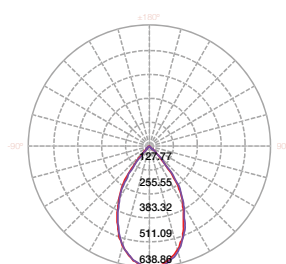

www.sal.net.au

DOWNLIGHT FITTING ASSEMBLED WITH S9053 LED MODULE

S9145, S9146 ECOSTAR II

CONSTRUCTION

- Die-cast aluminium body
- Powder coated finish
- High efficiency COB LED chip
- Changeable multi-reflector system
- 60° standard beam angle
- Polycarbonate optical lens
- Trailing edge dimmable LED driver included
- 1.2 m flex & plug fitted

APPLICATIONS

- Residential
- Hotels
- Shops
- Conference Rooms
- Reception areas

DIMMING OPTIONS

- 1-10V dimming
- Digital dimming (DSI, DALI)

DIMENSIONS

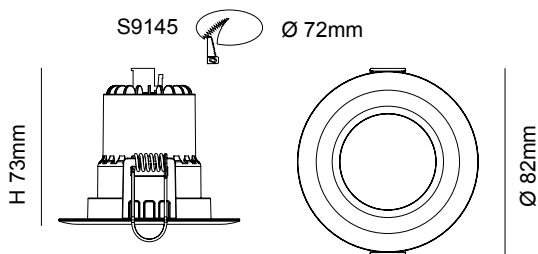

BEAM ANGLE OPTIONS

- 25° reflector
- 40° reflector

IP RATING

- IP20 suitable for indoor use only

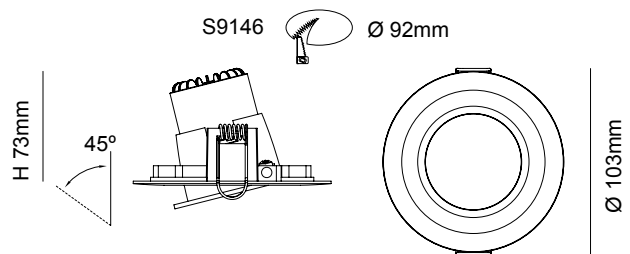

Model No.	Input	Power	Lumen	CCT	CRI	Beam Angle	Dimmable	Fitting Colour
S9145WW/WH	240V	9W	700lm	3000K	>82	60°	Yes	White
S9146WW/WH	240V	9W	700lm	3000K	>82	60°	Yes	White

PHOTOMETRIC DATA

Unit: cd

S9145WW/WH

C0/C180 ————
C90/C270 ————

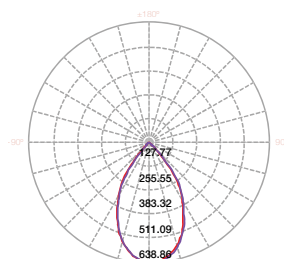

S9146WW/WH

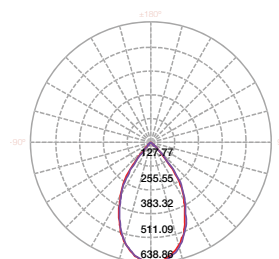

DOWNLIGHT FITTING ASSEMBLED WITH LED MODULES

S9006, S9007, S9008, S9009 UNIFIT

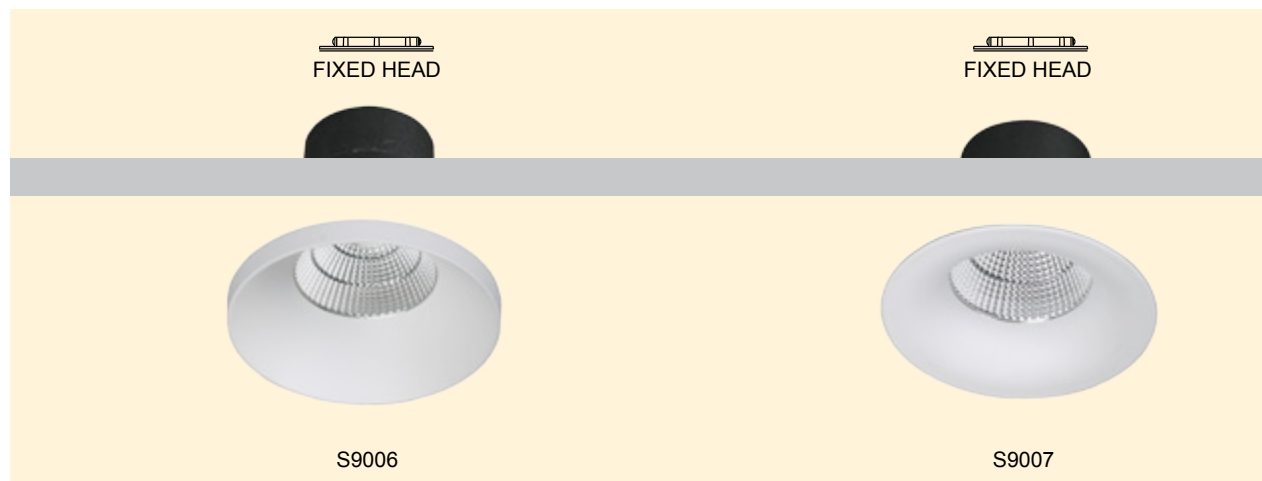

CONSTRUCTION

- Die-cast aluminium body
- Powder coated finish
- High efficiency COB LED chip
- Changeable multi-reflector system
- 60° standard beam angle
- Polycarbonate optical lens
- Trailing edge dimmable LED driver included
- 1.2 m flex & plug fitted

BEAM ANGLE OPTIONS

- 25° reflector
- 40° reflector

APPLICATIONS

- Residential
- Hotels
- Shops
- Conference Rooms
- Reception areas

DIMMING OPTIONS

- 1-10V dimming
- Digital dimming (DSI, DALI)

IP RATING

- IP20 suitable for indoor use only

Model No.	Input	Power	Lumen	CCT	CRI	Beam Angle	Dimmable	Fitting Colour
S9006WW	240V	9W	700lm	3000K	>82	60°	Yes	Matt White
S9006DL	240V	9W	800lm	6000K	>80	60°	Yes	Matt White
S9007WW	240V	9W	700lm	3000K	>82	60°	Yes	Matt White
S9007DL	240V	9W	800lm	6000K	>80	60°	Yes	Matt White
S9008WW	240V	9W	700lm	3000K	>82	60°	Yes	Matt White
S9008DL	240V	9W	800lm	6000K	>80	60°	Yes	Matt White
S9009WW	240V	9W	700lm	3000K	>82	60°	Yes	Matt White
S9009DL	240V	9W	800lm	6000K	>80	60°	Yes	Matt White

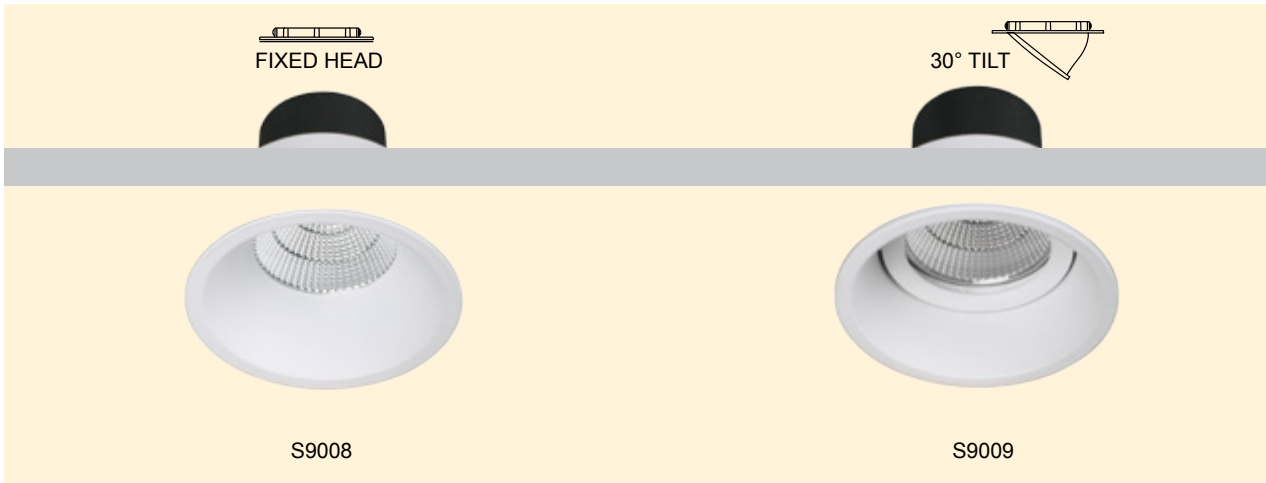

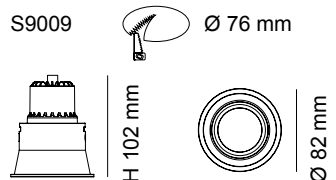
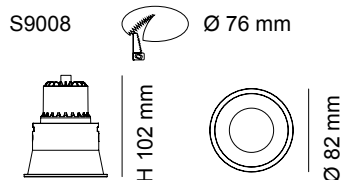
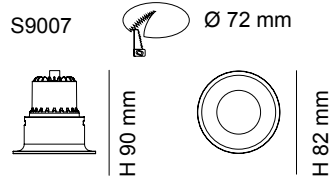
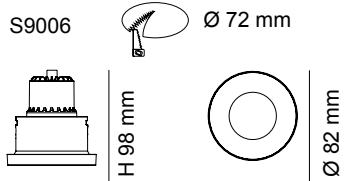

DIMENSIONS



PHOTOMETRIC DATA

Unit: cd

S9006WW, S9007WW, S9008WW, S9009WW C0/C180  C90/C270 

S9006DL, S9007DL, S9008DL, S9009DL

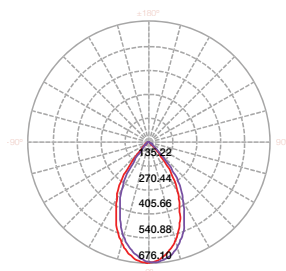
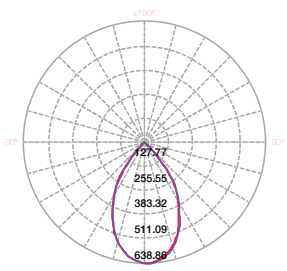

LED DOWNLIGHT

S9653C/LT40 KITS

CONSTRUCTION

- Pressed metal frame
- Powder coated finish (White)
- E27 lamp base
- Lamp not included
- High efficiency aluminium reflector
- IP20 suitable for indoor use only

IP RATING

- IP20 suitable for indoor use only

DIMENSIONS

S9653C

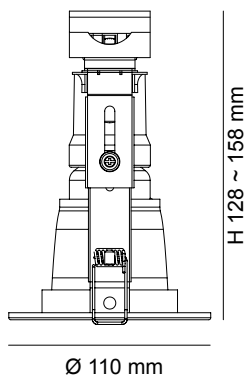

LED TUBULAR LAMPS

LT407

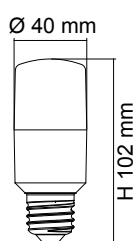

LT409

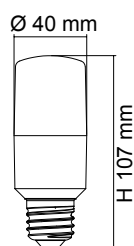

Lamp fitting in the Downlight

FITTING SPECIFICATION

Model No.	Input	Cut Out Size Ø	Fitting Colour	Lamp Base	1.2m Flex & Plug Fitted	Head	Diffuser
S9653 WH	240V	92 mm	White	E27	No	Fixed	Open Face
S9653 SN	240V	92 mm	Satin Nickel	E27	No	Fixed	Open Face
S9653P WH	240V	92 mm	White	E27	Yes	Fixed	Open Face
S9653P SN	240V	92 mm	Satin Nickel	E27	Yes	Fixed	Open Face
S9653C WH	240V	92 mm	White	E27	No	Fixed	Centre Frosted glass cover
S9653C SN	240V	92 mm	Satin Nickel	E27	No	Fixed	Centre Frosted glass cover
S9653C/P WH	240V	92 mm	White	E27	Yes	Fixed	Centre Frosted glass cover
S9653C/P SN	240V	92 mm	Satin Nickel	E27	Yes	Fixed	Centre Frosted glass cover



www.sal.net.au

LED GU10 DOWNLIGHT KITS

GU10 DOWNLIGHT FITTINGS (PLEASE SELECT ONE)

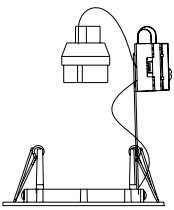

Model No.	Head	Dimension Ø	Cut Out Size Ø	Fitting Colour
S9001 SCH GU10	Fixed head, twist lock	81 mm	72 mm	Satin Chrome
S9001 WH GU10	Fixed head, twist lock	81 mm	72 mm	White
S9003 SCH GU10	Gimble 45°, twist lock	103 mm	92 mm	Satin Chrome
S9003 WH GU10	Gimble 45°, twist lock	103 mm	92 mm	White

PLUS

GU10 LED GLOBES (PLEASE SELECT ONE)



Model No.	Input	Power	Lumen	Beam Angle	CCT	CRI	Dimmable	Dimensions Ø x H	Lamp Base
GU10L350WW	240V	5W	300lm	38°	3000K	>80	No	50 x 52 mm	GU10
GU10L350DL	240V	5W	350lm	38°	6000K	>80	No	50 x 52 mm	GU10
GU10L550WW	240V	7W	500lm	50°	3000K	>80	No	50 x 52 mm	GU10
GU10L550DL	240V	7W	550lm	50°	6000K	>80	No	50 x 52 mm	GU10
GU10LR750WW	240V	9W	700lm	60°	3000K	>80	No	50 x 70 mm	GU10
GU10LR750DL	240V	9W	750lm	60°	6000K	>80	No	50 x 70 mm	GU10
GU10LA750WW	240V	9W	700lm	60°	3000K	>80	Yes	50 x 70 mm	GU10
GU10LA750DL	240V	9W	750lm	60°	6000K	>80	Yes	50 x 70 mm	GU10

LED LOW VOLTAGE DOWNLIGHT KITS (ROUND)

S9001, S9002, S9003, S9004 DOWNLIGHT FITTINGS (PLEASE SELECT ONE)

Model No.	Head	Dimension Ø	Cut Out Size Ø	Fitting Colour
S9001WH	Fixed head, twist lock	81mm	72mm	White
S9001CH	Fixed head, twist lock	81mm	72mm	Chrome
S9001GL	Fixed head, twist lock	81mm	72mm	Gold
S9001SC	Fixed head, twist lock	81mm	72mm	Satin Chrome
S9001SN	Fixed head, twist lock	81mm	72mm	Satin Nickel
S9002WH	Centre tilt 30°, twist lock	95mm	80mm	White
S9002CH	Centre tilt 30°, twist lock	95mm	80mm	Chrome
S9002GL	Centre tilt 30°, twist lock	95mm	80mm	Gold
S9002SC	Centre tilt 30°, twist lock	95mm	80mm	Satin Chrome
S9002SN	Centre tilt 30°, twist lock	95mm	80mm	Satin Nickel
S9003WH	Gimble 45°, twist lock	103mm	92mm	White
S9003CH	Gimble 45°, twist lock	103mm	92mm	Chrome
S9003GL	Gimble 45°, twist lock	103mm	92mm	Gold
S9003SC	Gimble 45°, twist lock	103mm	92mm	Satin Chrome
S9003SN	Gimble 45°, twist lock	103mm	92mm	Satin Nickel
S9004WH	Gimble 45°, rotatable 355°	103mm	94mm	White
S9004CH	Gimble 45°, rotatable 355°	103mm	94mm	Chrome
S9004SC	Gimble 45°, rotatable 355°	103mm	94mm	Satin Chrome
S9004SN	Gimble 45°, rotatable 355°	103mm	94mm	Satin Nickel



PLUS

LED LOW VOLTAGE GLOBES (PLEASE SELECT ONE)

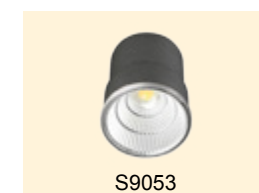

Model No.	Input	Power	Lumen	Beam Angle	CCT	CRI	Dimmable	Dimensions Ø x H	Lamp Base
MR16 5W WW	12V AC or DC	5W	330lm	38°	3000K	>80	No	50 x 49 mm	GU5.3
MR16 5W DL	12V AC or DC	5W	350lm	38°	6000K	>80	No	50 x 49 mm	GU5.3
MR16/7W/WW	12V AC or DC	7W	500lm	60°	3000K	>80	No	50 x 49 mm	GU5.3
MR16/7W/DL	12V AC or DC	7W	550lm	60°	6000K	>80	No	50 x 49 mm	GU5.3
MR16DIM9W/WW	12V AC or DC	9W	500lm	60°	3000K	>80	Yes	50 x 49 mm	GU5.3
MR16DIM9W/DL	12V AC or DC	9W	550lm	60°	6000K	>80	Yes	50 x 49 mm	GU5.3

OR

LED LOW VOLTAGE MODULES (PLEASE SELECT ONE)

Model No.	Input	Power	Lumen	CCT	CRI	Beam Angle	Dimmable
S9053 WP (NO TRANSFORMER REQUIRED)	240V	9W	700lm	3000K	>82	60°	Yes
S9053 DP (NO TRANSFORMER REQUIRED)	240V	9W	800lm	6000K	>80	60°	Yes

PLUS (IF LED LOW VOLTAGE GLOBES SELECTED)

ELECTRONIC TRANSFORMERS (PLEASE SELECT ONE)

Model No.	Input	Power	Output	Input Current	Power Factor	Dimensions L x W x H	1.2 m Flex & Plug Fitted
MINI60	240V	20-60W	11.5V	0.26mA	0.99	109 x 42 x 24 mm	No
MINI/P60	240V	20-60W	11.5V	0.26mA	0.99	109 x 42 x 24 mm	Yes



LED LOW VOLTAGE DOWNLIGHT KITS (SQUARE)

S9401, S9404, S9408, S9413 DOWNLIGHT FITTINGS (PLEASE SELECT ONE)

Model No.	Head	Dimension Ø	Cut Out Size Ø	Fitting Colour
S9404WH	Centre tilt 30°, twist lock	92 x 92 x54 mm	86 mm	White
S9404SL	Centre tilt 30°, twist lock	92 x 92 x54 mm	86 mm	Silver
S9404SN	Centre tilt 30°, twist lock	92 x 92 x54 mm	86 mm	Satin Nickel
S9408SL	Centre tilt 30°, twist lock	100 x 100 x 44 mm	90 mm	Silver
S9401CH	Centre tilt 30°, twist lock	92mm x 92mm	80mm	Chrome
S9401GL	Centre tilt 30°, twist lock	92mm x 92mm	80mm	Gold
S9401SC	Centre tilt 30°, twist lock	92mm x 92mm	80mm	Satin Chrome
S9401SN	Centre tilt 30°, twist lock	92mm x 92mm	80mm	Satin Nickel
S9413WH	Gimble 45°, twist lock	103mm x 103mm	92mm	White
S9413BK	Gimble 45°, twist lock	103mm x 103mm	92mm	Black
S9413CH	Gimble 45°, twist lock	103mm x 103mm	92mm	Chrome
S9413GL	Gimble 45°, twist lock	103mm x 103mm	92mm	Gold
S9413SC	Gimble 45°, twist lock	103mm x 103mm	92mm	Satin Chrome

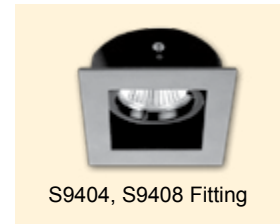

PLUS

LED LOW VOLTAGE GLOBES (PLEASE SELECT ONE)

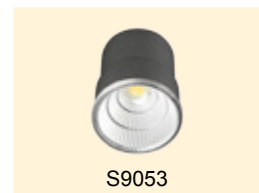

Model No.	Input	Power	Lumen	Beam Angle	CCT	CRI	Dimmable	Dimensions Ø x H	Lamp Base
MR16 5W WW	12V AC or DC	5W	330lm	38°	3000K	>80	No	50 x 49 mm	GU5.3
MR16 5W DL	12V AC or DC	5W	350lm	38°	6000K	>80	No	50 x 49 mm	GU5.3
MR16/7W/WW	12V AC or DC	7W	500lm	60°	3000K	>80	No	50 x 49 mm	GU5.3
MR16/7W/DL	12V AC or DC	7W	550lm	60°	6000K	>80	No	50 x 49 mm	GU5.3
MR16DIM9W/WW	12V AC or DC	9W	500lm	60°	3000K	>80	Yes	50 x 49 mm	GU5.3
MR16DIM9W/DL	12V AC or DC	9W	550lm	60°	6000K	>80	Yes	50 x 49 mm	GU5.3

OR

LED LOW VOLTAGE MODULES (PLEASE SELECT ONE)

Model No.	Input	Power	Lumen	CCT	CRI	Beam Angle	Dimmable
S9053 WP (NO TRANSFORMER REQUIRED)	240V	9W	700lm	3000K	>82	60°	Yes
S9053 DP (NO TRANSFORMER REQUIRED)	240V	9W	800lm	6000K	>80	60°	Yes

PLUS (IF LED LOW VOLTAGE GLOBES SELECTED)

ELECTRONIC TRANSFORMERS (PLEASE SELECT ONE)

Model No.	Input	Power	Output	Input Current	Power Factor	Dimensions L x W x H	1.2 m Flex & Plug Fitted
MINI60	240V	20-60W	11.5V	0.26mA	0.99	109 x 42 x 24 mm	No
MINI/P60	240V	20-60W	11.5V	0.26mA	0.99	109 x 42 x 24 mm	Yes





LED OYSTER & PENDANT LIGHTS





SO3700 OPAL	53
SO3701 GEM	55
SL2105 DISC	56
SO3800 OPAL II	57
SL2108 DISH I	58
SL2109 DISH II	58
SO2107, SL2107 PEARL	59
SO2101 LED ALABASTER	60
SO3103 LED SPIKE	61
SO3109 LED SOLAR	62
SO3160 SHELL	63
SL3147 FLORIO	64
SPL015 INDUSTRIAL	65
SPL016 URBAN	66
SPL017 CITY	67
SPL018 CHIC	68
SPL019 DROP	69
SPL3100 CLASSIC RING	71
SPL3200 RING	73

LED OYSTER LIGHT

SO3700 OPAL

CONSTRUCTION

- Powder coated steel base
- Opal polycarbonate diffuser
- Built-in high efficiency SMD LED chips
- Constant current LED driver fitted

IP RATING

- IP20 suitable for indoor use only

DIMMING OPTIONS

- Analogue dimming (trailing edge, 1-10V)
- Digital dimming (DSI, DALI)
- SO3700/40L – integrated microwave sensor (SMS800)

DIMENSIONS

SO3700/30

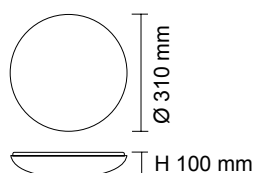

SO3700/40

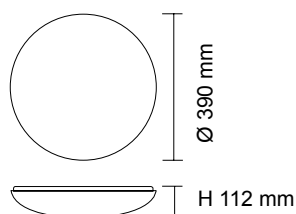

SO3700/30L



SO3700/40L

Model No.	Input	Power	Lumen	CCT	CRI
SO3700/30L WW	240V	18W	1500lm	3000K	>80
SO3700/30L CW	240V	18W	1600lm	4000K	>80
SO3700/30L DL	240V	18W	1600lm	6000K	>80

Model No.	Input	Power	Lumen	CCT	CRI
SO3700/40L WW	240V	30W	2500lm	3000K	>80
SO3700/40L CW	240V	30W	2600lm	4000K	>80
SO3700/40L DL	240V	30W	2700lm	6000K	>80





LED OYSTER LIGHT

SO3701 GEM

CONSTRUCTION

- Powder coated steel base
- Satin Nickel plated deco ring
- Opal polycarbonate diffuser
- Built-in high efficiency SMD LED chips
- Constant current LED driver fitted

IP RATING

- IP20 suitable for indoor use only

DIMMING OPTIONS

- Analogue dimming (trailing edge, 1-10V)
- Digital dimming (DSI, DALI)
- SO3701/40L – integrated microwave sensor (SMS800)

DIMENSIONS

SO3701/30L

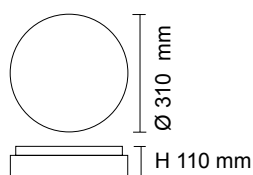

SO3701/30L

SO3701/40L

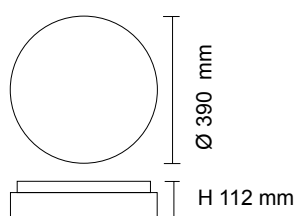

SO3701/40L

Model No.	Input	Power	Lumen	CCT	CRI
SO3701/30L WW	240V	18W	1300lm	3000K	>80
SO3701/30L CW	240V	18W	1450lm	4000K	>80
SO3701/30L DL	240V	18W	1450lm	6000K	>80

Model No.	Input	Power	Lumen	CCT	CRI
SO3701/40L WW	240V	30W	2250lm	3000K	>80
SO3701/40L CW	240V	30W	2350lm	4000K	>80
SO3701/40L DL	240V	30W	2450lm	6000K	>80



DIMMABLE – ULTRA SLIM LED OYSTER LIGHT

SL2105 DISC



CONSTRUCTION

- Polycarbonate housing
- Opal polycarbonate diffuser
- Double insulation
- Built-in high efficiency SMD LED chips
- Built-in trailing edge dimmable LED driver

IP RATING

- IP54 weatherproof

DIMENSIONS

SL2105/20

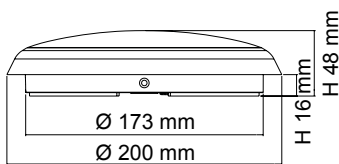

SL210530

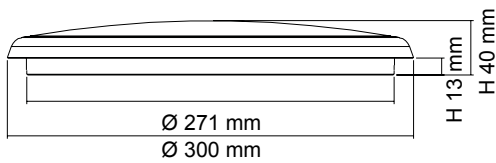

SL2105/40

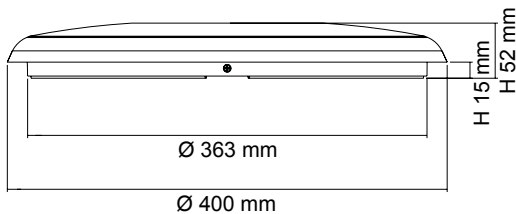

Model No.	Input	Power	Lumen	CCT	CRI	Dimensions Ø x H	Fitting Colour
SL2105/20WW	240V	12W	1050lm	3000K	>80	200 x 48 mm	White
SL2105/20DL	240V	12W	1100lm	5000K	>80	200 x 48 mm	White
SL2105/30WW	240V	25W	2000lm	3000K	>80	300 x 40 mm	White
SL2105/30DL	240V	25W	2200lm	5000K	>80	300 x 40 mm	White
SL2105/40WW	240V	30W	2800lm	3000K	>80	400 x 52 mm	White
SL2105/40DL	240V	30W	2900lm	5000K	>80	400 x 52 mm	White

COMMERCIAL GRADE LED OYSTER LIGHT

SO3800 OPAL II

CONSTRUCTION

- Powder coated steel body
- Opal polycarbonate diffuser
- High efficiency SMD LED chips
- Constant current LED driver fitted

IP RATING

- IP20 suitable for indoor use only

DIMMING OPTIONS

- Analogue dimming (Trailing edge, 1-10V dimming)
- Digital dimming (DSI, DALI)
- Integrated microwave sensor (SMS800)

EMERGENCY OPTIONS

- Compliant to AS2293
- Emergency classification: D25

DIMENSIONS

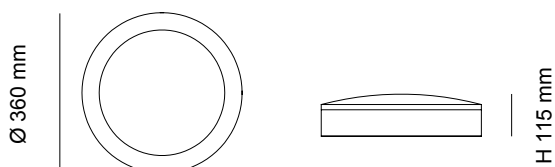

Model No.	Input	Power	Lumen	CCT	CRI	Fitting Colour
SO3800/40 WW	240V	21W	1600lm	3000K	>80	White
SO3800/40 CW	240V	21W	1650lm	4000K	>80	White
SO3800/40 DL	240V	21W	1700lm	6000K	>80	White

EMERGENCY

Model No.	Input	Power	Lumen	CCT	CRI	Fitting Colour
SO3800EM WW	240V	21W/3W	1600lm/260lm	3000K	>80	White
SO3800EM CW	240V	21W/3W	1650lm/260lm	4000K	>80	White
SO3800EM DL	240V	21W/3W	1700lm/260lm	6000K	>80	White

PHOTOMETRIC DATA

Unit: cd

SO3800/40 CW C0/C180 —
C90/C270 —

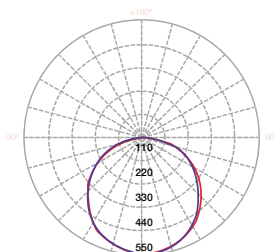

www.sal.net.au

ULTRA SLIM LED OYSTER LIGHT

SL2108 DISH I

CONSTRUCTION

- Powder coated steel base
- Complete with two interchangeable white or silver trims
- Opal acrylic diffuser
- Built-in high efficiency SMD LED chips
- Constant current LED driver fitted

IP RATING

- IP44 weatherproof

DIMENSIONS

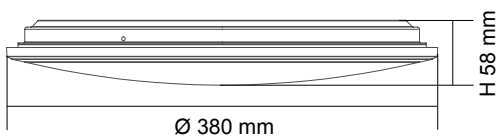

Model No.	Input	Power	Lumen	CCT	CRI
SL2108WW	240V	22W	1900lm	3000K	>80
SL2108DL	240V	22W	1900lm	5000K	>80

PHOTOMETRIC DATA

Unit: cd

SL2108 WW

C0/C180

C90/C270

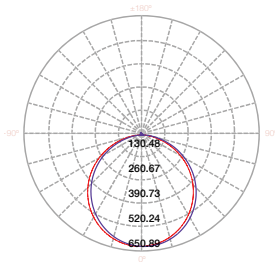

SL2108 DL

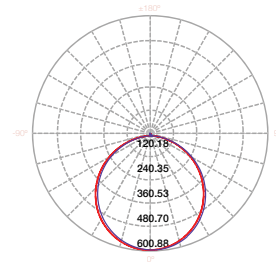

ULTRA SLIM LED OYSTER LIGHT

SL2109 DISH II

CONSTRUCTION

- ABS base plate and housing
- Rear access installation design
- Opal acrylic diffuser
- Double insulation
- Built-in high efficiency SMD LED chips
- Constant current LED driver fitted

IP RATING

- IP44 weatherproof

DIMENSIONS

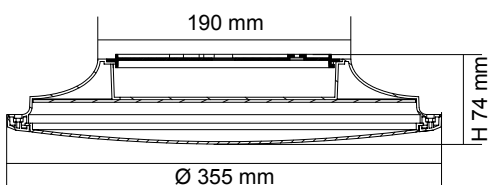

Model No.	Input	Power	Lumen	CCT	CRI
SL2109/40WW	240V	25W	2000lm	3000K	>80
SL2109/40CW	240V	25W	2200lm	4000K	>80
SL2109/40DL	240V	25W	2400lm	6000K	>80

LED OYSTER LIGHT

SO2107, SL2107 PEARL

CONSTRUCTION

- Powder coated steel base
- Opal polycarbonate diffuser
- Built-in E27 lampholder(s) or LED conversion kit

IP RATING

- IP44 weatherproof

LAMP OPTIONS (SO2107)

- LG3 3W, LG5 5W, LG7 7W, LG9 9W
- LGS4, LGS8, LGS10, LGS11D
- LT407, LT409
- LCA35 3W, LFR35 3W

DIMENSIONS

SO2107

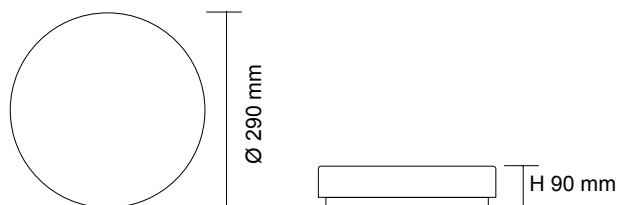

SL2107

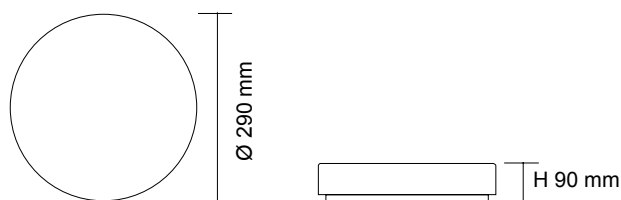

PHOTOMETRIC DATA

Unit: cd

SL2107/30DL

C0/C180

C90/C270

Model No.	Input	Lamp Base
SO2107	240V	E27 x 2

Model No.	Input	Power	Lumen	CCT	CRI
SL2107/30WW	240V	18W	1200lm	3000K	>80
SL2107/30DL	240V	18W	1200lm	6000K	>80

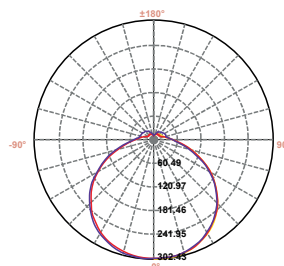

www.sal.net.au

LED OYSTER LIGHT

SO2101 LED ALABASTER

OYSTER FITTINGS

SW2101, SO2101/30, SO2101/40 ALABASTER



SW2101

SO2101/30 LED, SO2101/30

SO2101/40 LED, SO2101/40

CONSTRUCTION

- Powder coated steel base
- Die-cast clips with various colours
- Alabaster glass diffuser
- Built-in E27 lampholder(s) or LED conversion kit
- Lamps NOT included

LAMP OPTIONS

- LG3 3W, LG5 5W, LG7 7W, LG9 9W
- LGS4, LGS8, LGS10, LGS11D
- LT407, LT409
- LCA35 3W, LFR35 3W

IP RATING

- IP20 suitable for indoor use only

DIMENSIONS

SW2101

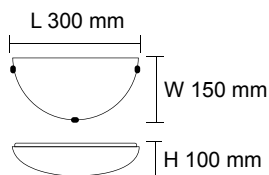

SO2101/30 LED, SO2101/30

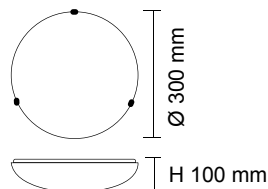

SO2101/40 LED, SO2101/40

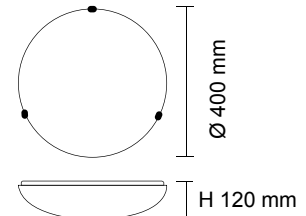

Model No.	Input	Power	Lumen	CCT	CRI
SO2101/30 LED	240V	12W	1200lm	3000K / 4000K / 6000K	>80
SO2101/40 LED	240V	20W	1800lm	3000K / 4000K / 6000K	>80

Model No.	Input	Clips Colour	Lamp Base
SW2101 WH	240V	White	E27
SW2101 SC	240V	Satin Chrome	E27
SW2101 GD	240V	Gold	E27
SW2101 CH	240V	Chrome	E27
SW2101 AB	240V	Antique Brass	E27

Model No.	Input	Clips Colour	Lamp Base
SO2101/30 WH	240V	White	E27
SO2101/30 SC	240V	Satin Chrome	E27
SO2101/30 GD	240V	Gold	E27
SO2101/30 CH	240V	Chrome	E27
SO2101/30 AB	240V	Antique Brass	E27

CLIP COLOURS



Model No.	Input	Clips Colour	Lamp Base
SO2101/40 WH	240V	White	E27 x 2
SO2101/40 SC	240V	Satin Chrome	E27 x 2
SO2101/40 GD	240V	Gold	E27 x 2
SO2101/40 CH	240V	Chrome	E27 x 2
SO2101/40 AB	240V	Antique Brass	E27 x 2

LED OYSTER LIGHT

SO3103 LED SPIKE

OYSTER FITTINGS

SW3103, SO3103/30, SO3103/40 SPIKE

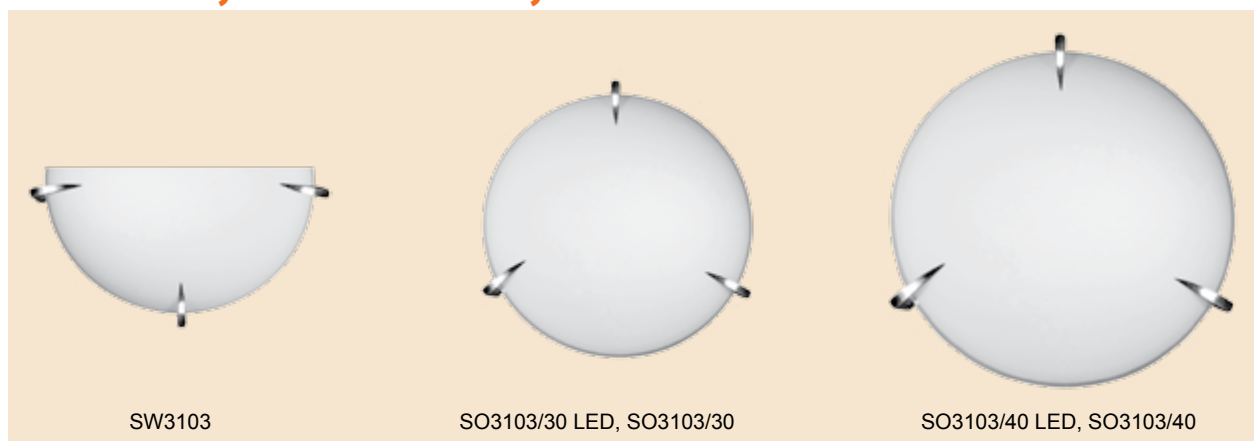

CONSTRUCTION

- Powder coated steel base
- Die-cast clips with various colours
- Frosted glass diffuser
- Built-in E27 lampholder(s) or LED conversion kit
- Lamps NOT included

LAMP OPTIONS

- LG3 3W, LG5 5W, LG7 7W, LG9 9W
- LGS4, LGS8, LGS10, LGS11D
- LT407, LT409
- LCA35 3W, LFR35 3W

IP RATING

- IP20 suitable for indoor use only

DIMENSIONS

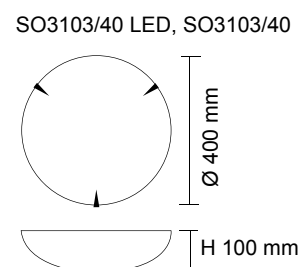
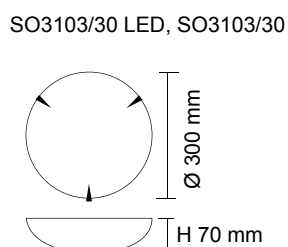
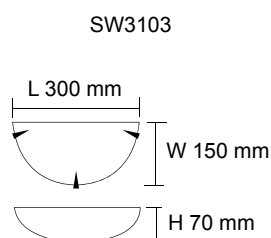

Model No.	Input	Power	Lumen	CCT	CRI
SO3103/30 LED	240V	12W	1200lm	3000K / 4000K / 6000K	>80
SO3103/40 LED	240V	20W	1800lm	3000K / 4000K / 6000K	>80

Model No.	Input	Clips Colour	Lamp Base
SW3103 CH	240V	Chrome	E27
SW3103 SC	240V	Satin Chrome	E27
SW3103 GD	240V	Gold	E27

Model No.	Input	Clips Colour	Lamp Base
SO3103/30 CH	240V	Chrome	E27
SO3103/30 SC	240V	Satin Chrome	E27
SO3103/30 GD	240V	Gold	E27

CLIP COLOURS:



Model No.	Input	Clips Colour	Lamp Base
SO3103/40 CH	240V	Chrome	E27 x 2
SO3103/40 SC	240V	Satin Chrome	E27 x 2
SO3103/40 GD	240V	Gold	E27 x 2

LED OYSTER LIGHT

SO3109 LED SOLAR

OYSTER FITTINGS

SW3109, SO3109/30, SO3109/40 SOLAR



SW3109

SO3109/30 LED, SO3109/30

SO3109/40 LED, SO3109/40

CONSTRUCTION

- Powder coated steel base
- Satin Nickel plated clips
- Frosted glass diffuser
- Built-in E27 lampholder(s) or LED conversion kit
- Lamps NOT included

LAMP OPTIONS

- LG3 3W, LG5 5W, LG7 7W, LG9 9W
- LGS4, LGS8, LGS10, LGS11D
- LT407, LT409
- LCA35 3W, LFR35 3W

IP RATING

- IP20 suitable for indoor use only

DIMENSIONS

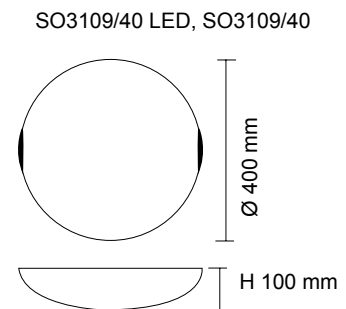
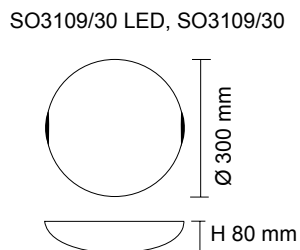
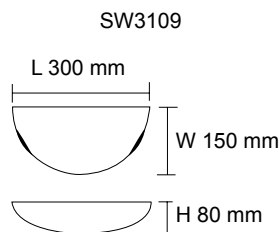

Model No.	Input	Power	Lumen	CCT	CRI
SO3109/30 LED	240V	12W	1200lm	3000K / 4000K / 6000K	>80
SO3109/40 LED	240V	20W	1800lm	3000K / 4000K / 6000K	>80

Model No.	Input	Clips Colour	Lamp Base
SW3109	240V	Satin Nickel	E27
SO3109/30	240V	Satin Nickel	E27
SO3109/40	240V	Satin Nickel	E27 x 2

LED OYSTER LIGHT

SO3160 SHELL

CONSTRUCTION

- Premier aluminium housing
- Chrome plated centre locking disc
- Opal acrylic diffuser
- Built-in high efficiency SMD LED chips
- Constant current LED driver fitted

IP RATING

- IP20 suitable for indoor use only

DIMENSIONS

SO3160/30

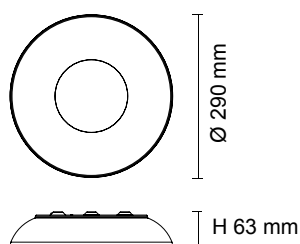

SO3160/45

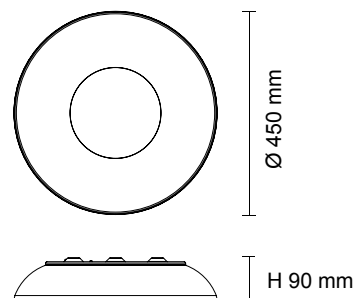

Model No.	Input	Power	Lumen	CCT	CRI	Beam Angle	Dimensions Ø x H	Fitting Colour
SO3160/30	240V	14W	900lm	3000K	>80	90°	290 x 63 mm	Anodized Silver
SO3160/45	240V	30W	1800lm	3000K	>80	90°	450 x 90 mm	Anodized Silver

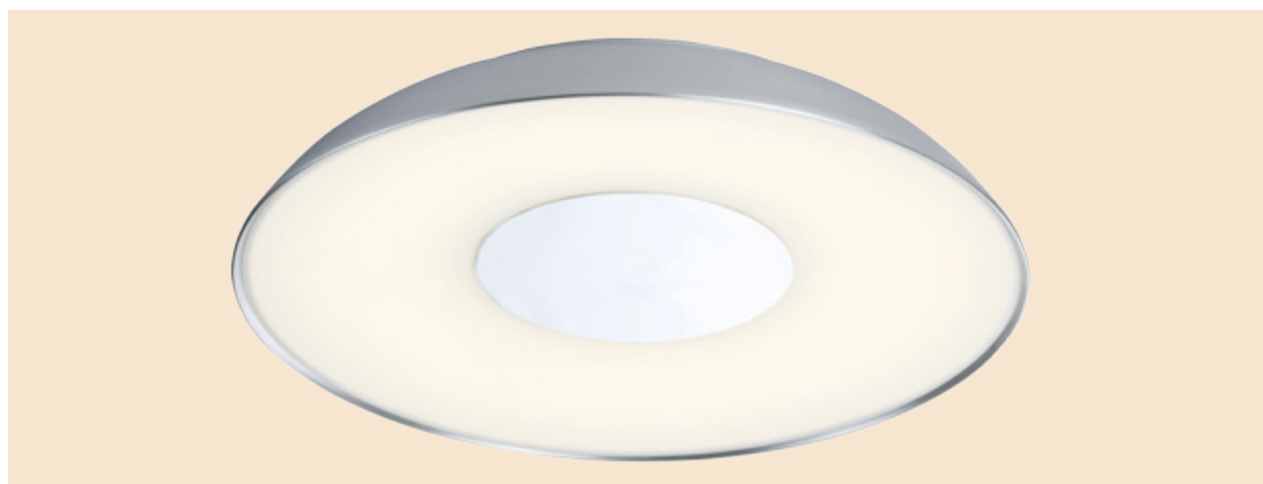

LED OYSTER LIGHT

SL3147 FLORIO

CONSTRUCTION

- Extruded aluminium frame
- Powder coated metal base
- Opal polystyrene diffuser
- High efficiency SMD LED chips
- Constant current LED driver fitted

IP RATING

- IP20 suitable for indoor use only

DIMMING OPTIONS

- Analogue dimming (Trailing edge, 1-10V dimming)
- Digital dimming (DSI, DALI)
- Integrated microwave sensor (SMS800)

DIMENSIONS

SL3147/28

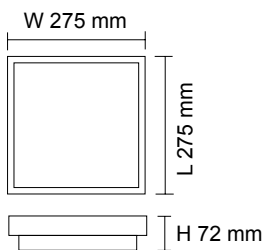

SL3147/35

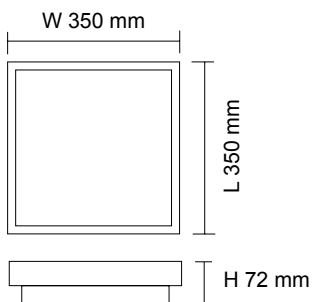

Model No.	Input	Power	Lumen	CCT	CRI	Dimensions L x W X H	Fitting Colour
SL3147/28CW	240V	14W	900lm	4000K	>80	275 x 275 X 72 mm	Anodized Silver
SL3147/35CW	240V	22W	1500lm	4000K	>80	350 x 350 X 72 mm	Anodized Silver

LED PENDANT LIGHT SPL015 INDUSTRIAL

CONSTRUCTION

- Extruded aluminium body
- Frosted glass diffuser
- Built-in high output LED chips
- Constant current LED driver fitted

IP RATING

- IP20 suitable for indoor use only

DIMENSIONS

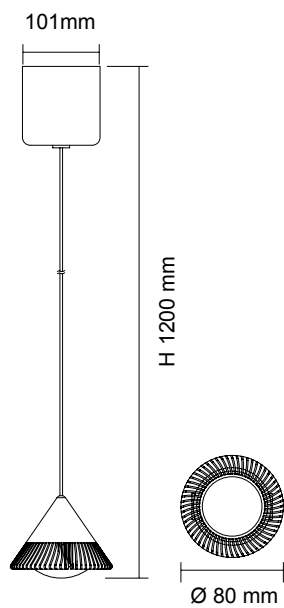

Model No.	Input	Power	Lumen	CCT	CRI	Beam Angle	Fitting Colour
SPL015	240V	12W	700lm	3000K	>80	60°	Anodized Silver



LED PENDANT LIGHT SPL016 URBAN

CONSTRUCTION

- Extruded aluminium body with glass housing
- Multi-glass lens
- Built-in high output LED chips
- Constant current LED driver fitted

IP RATING

- IP20 suitable for indoor use only

DIMENSIONS

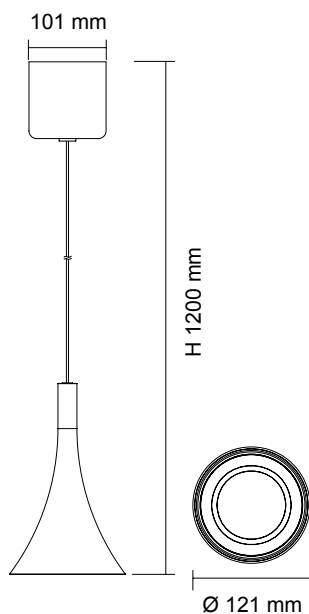

Model No.	Input	Power	Lumen	CCT	CRI	Beam Angle	Fitting Colour
SPL016	240V	9W	500lm	3000K	>80	15°	Anodized Silver

LED PENDANT LIGHT SPL017 CITY

CONSTRUCTION

- Extruded aluminium body
- Frosted glass diffuser
- Built-in high output LED chips
- Constant current LED driver fitted

IP RATING

- IP20 suitable for indoor use only

DIMENSIONS

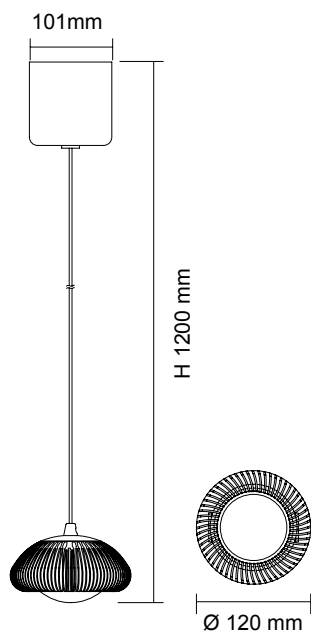

Model No.	Input	Power	Lumen	CCT	CRI	Beam Angle	Fitting Colour
SPL017	240V	12W	700lm	3000K	>80	60°	Anodized Silver



www.sal.net.au

LED PENDANT LIGHT SPL018 CHIC

CONSTRUCTION

- Extruded aluminium body with glass housing
- Frosted glass diffuser
- Built-in high output LED chips
- Constant current LED driver fitted

IP RATING

- IP20 suitable for indoor use only

DIMENSIONS

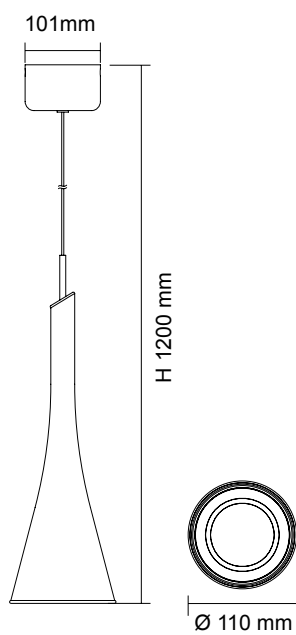

Model No.	Input	Power	Lumen	CCT	CRI	Beam Angle	Fitting Colour
SPL018	240V	20W	1000lm	3000K	>80	75°	Anodized Silver

LED PENDANT LIGHT

SPL019 DROP

CONSTRUCTION

- Aluminium body
- Opal acrylic diffuser
- Built-in high output LED chips
- Constant current LED driver fitted

IP RATING

- IP20 suitable for indoor use only

DIMENSIONS

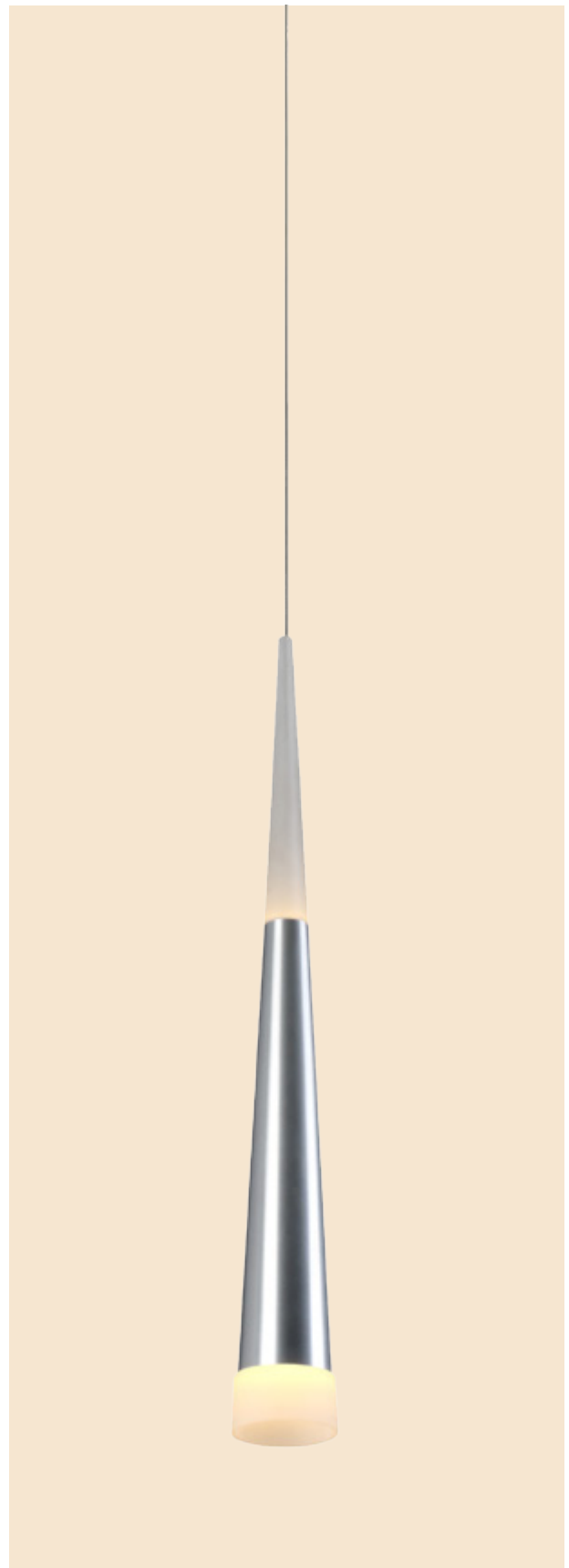
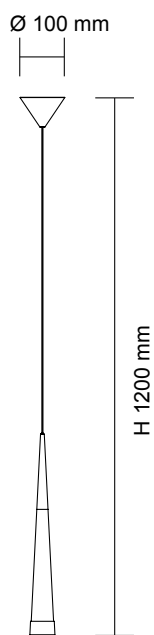

Model No.	Input	Power	Lumen	CCT	CRI	Beam Angle	Fitting Colour
SPL019	240V	6.5W	350lm	3000K	>80	60°	Anodized Silver





LED PENDANT LIGHT

SPL3100 CLASSIC RING

CONSTRUCTION

- Polyurethane body
- Opal acrylic diffuser
- Built-in high efficiency SMD LED chips
- Constant current LED driver fitted

IP RATING

- IP20 suitable for indoor use only

DIMENSIONS

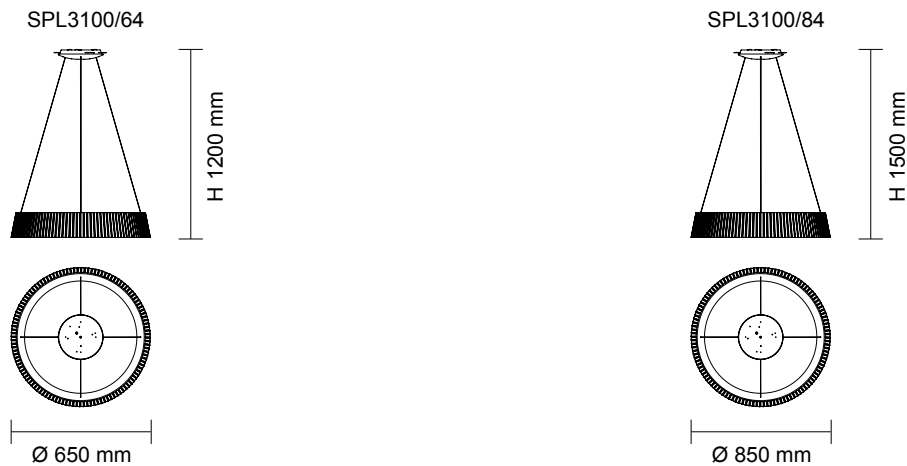

Model No.	Input	Power	Lumen	CCT	CRI	Fitting Colour
SPL3100/64	240V	45W	2250lm	3000K	>80	White
SPL3100/84	240V	67W	3300lm	3000K	>80	White



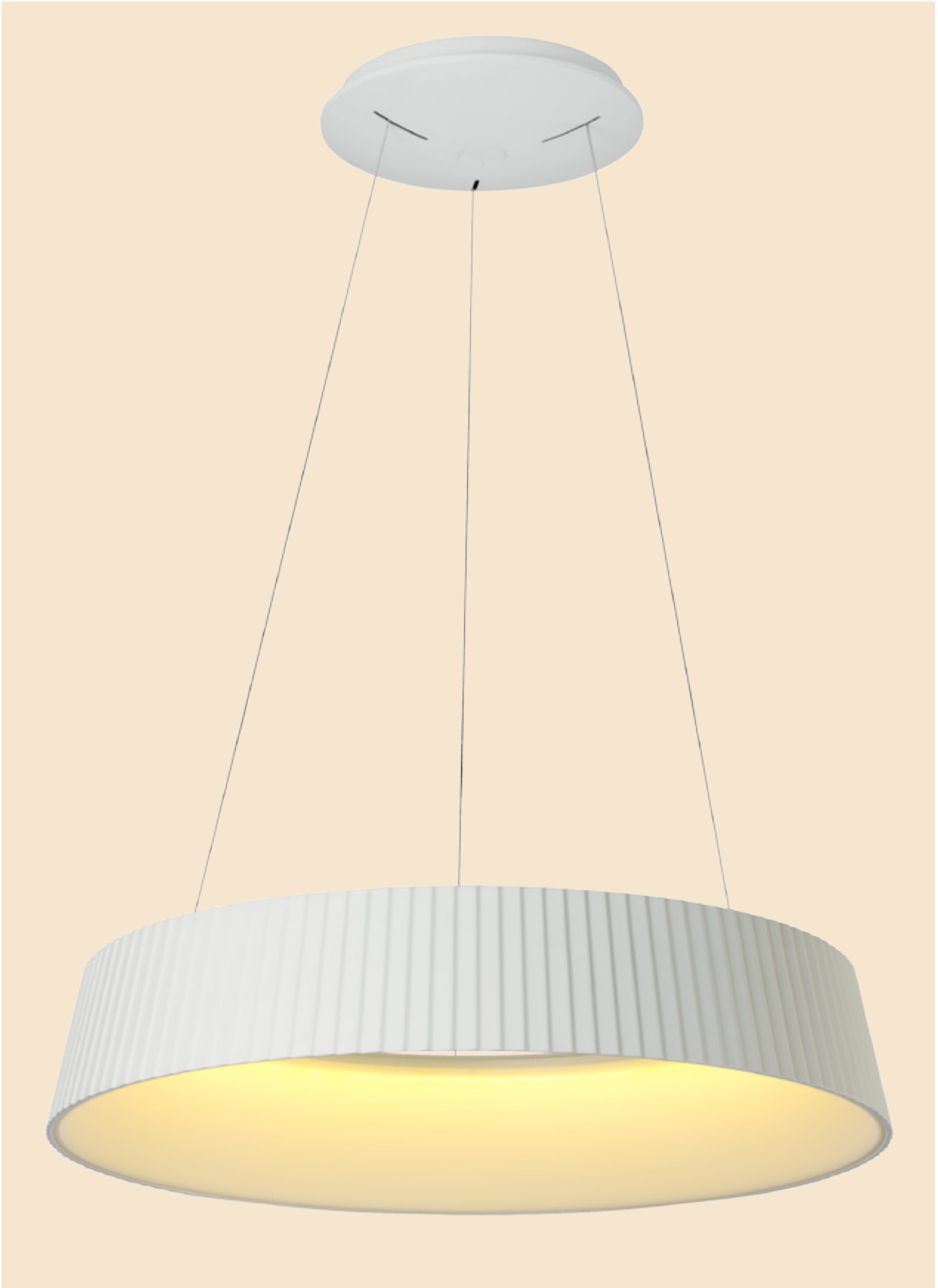

LED PENDANT LIGHT

SPL3200 RING

CONSTRUCTION

- Aluminium body
- Opal acrylic diffuser
- Built-in high efficiency SMD LED chips
- Constant current LED driver fitted

IP RATING

- IP20 suitable for indoor use only

DIMENSIONS

SPL3200/46

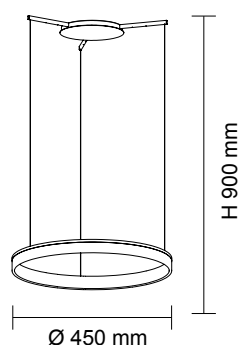

SPL3200/60

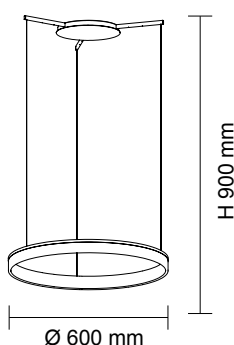

SPL3200/81

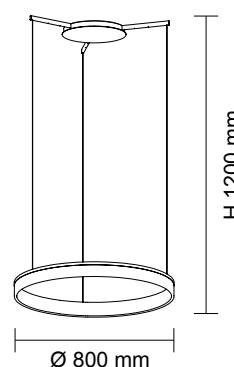

SPL3200/2R

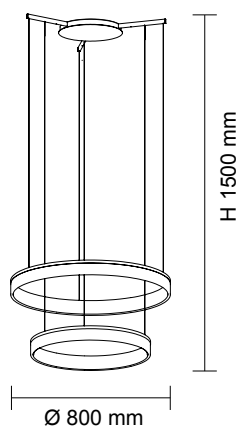

SPL3200/3R

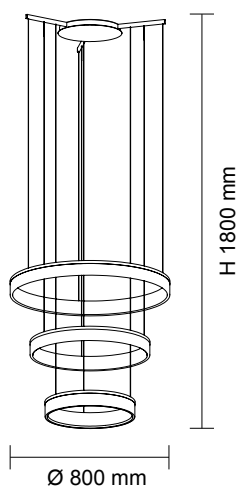

Model No.	Input	Power	Lumen	CCT	CRI	Fitting Colour
SPL3200/46	240V	17W	900lm	3000K	>80	Black
SPL3200/60	240V	23W	1200lm	3000K	>80	Black
SPL3200/81	240V	30W	1500lm	3000K	>80	Black
SPL3200/2R	240V	53W	2700lm	3000K	>80	Black
SPL3200/3R	240V	70W	3600lm	3000K	>80	Black





LED CABINET & WALL LIGHTS

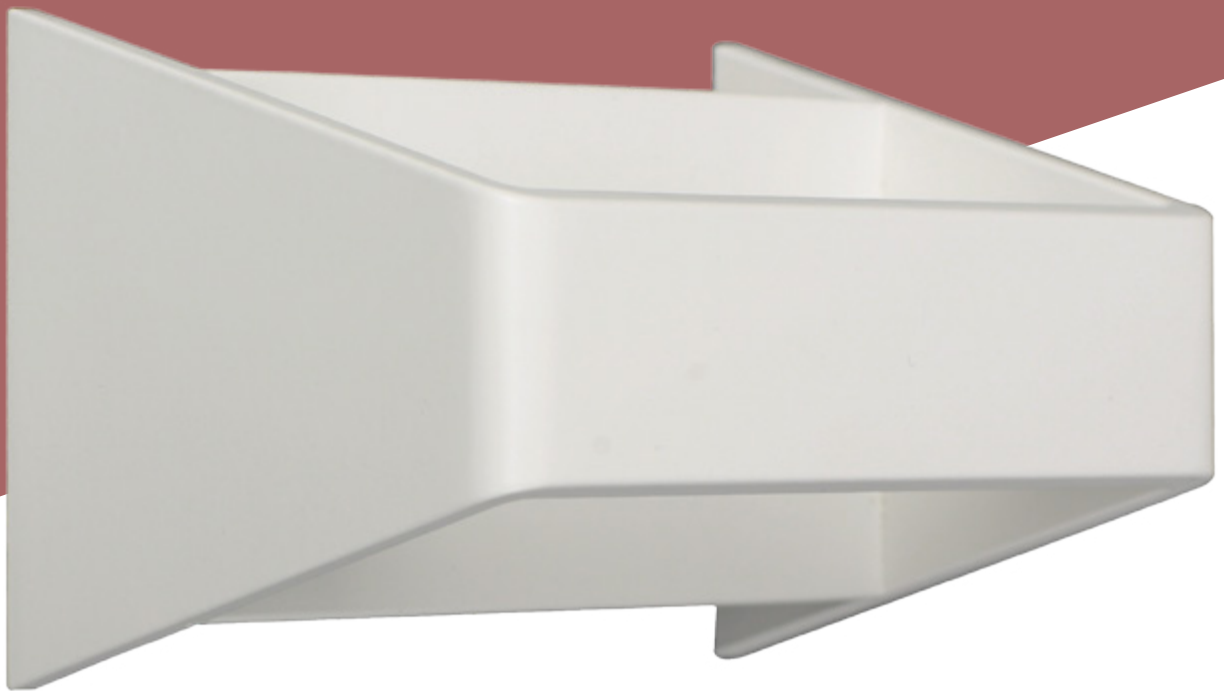

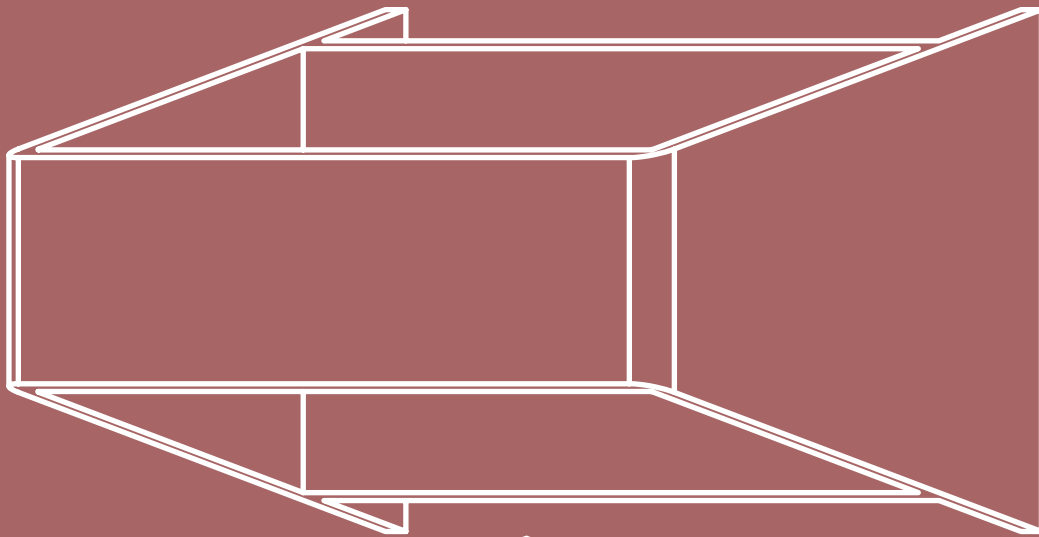

S9105, S9105 SR, S9105 ST ANOVA	77
S9113, S9114, S9115 DISC	78
S9511/LED, S9512/LED DESERT	79
S9515 BEACON	80
S9316, S9317 DARHAM	81
S9318 LEEMAN	82
S9311 BROOM	83
S9327, S9328 LOUNGE I & II	84
S9320 CUBE	85
S9356 UD	86

LED CABINET LIGHT

S9105, S9105 SR, S9105 ST ANOVA

CONSTRUCTION

- Die cast aluminium body
- Powder coated finish
- Super bright SMD LED chips
- 12V DC LED driver required

IP RATING

- IP20 suitable for indoor use only

SUITABLE DRIVERS

- PLUTO EGL12V/6W
- PLUTO EGL12V/15W
- PLUTO 30W/12V, PLUTO 50W/12V,
- PLUTO 100W/12V, PLUTO 200W/12V

DIMENSIONS

S9105

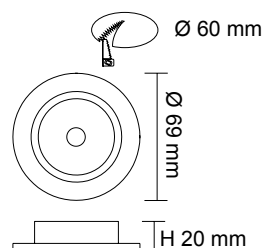

S9105 SR

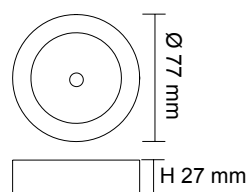

S9105 ST

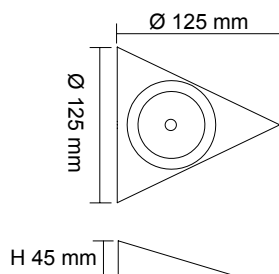

S9105



S9105 SR



S9105 ST

Model No.	Input	Power	Lumen	CCT	CRI	Beam Angle	Dimmable	Installation Type	Fitting Colour
S9105WW/WH	12V DC	4W	280lm	3000K	>82	90°	No	Recessed	White
S9105DL/WH	12V DC	4W	280lm	6000K	>82	90°	No	Recessed	White
S9105WW/SN	12V DC	4W	280lm	3000K	>82	90°	No	Recessed	Satin Nickel
S9105DL/SN	12V DC	4W	280lm	6000K	>82	90°	No	Recessed	Satin Nickel

Model No.	Input	Power	Lumen	CCT	CRI	Beam Angle	Dimmable	Installation Type	Fitting Colour
S9105WW SR/WH	12V DC	4W	280lm	3000K	>82	90°	No	Surface Mounted	White
S9105DL SR/WH	12V DC	4W	280lm	6000K	>82	90°	No	Surface Mounted	White
S9105WW SR/SN	12V DC	4W	280lm	3000K	>82	90°	No	Surface Mounted	Satin Nickel
S9105DL SR/SN	12V DC	4W	280lm	6000K	>82	90°	No	Surface Mounted	Satin Nickel

Model No.	Input	Power	Lumen	CCT	CRI	Beam Angle	Dimmable	Installation Type	Fitting Colour
S9105WW ST/WH	12V DC	4W	280lm	3000K	>82	90°	No	Surface Mounted	White
S9105DL ST/WH	12V DC	4W	280lm	6000K	>82	90°	No	Surface Mounted	White
S9105WW ST/SN	12V DC	4W	280lm	3000K	>82	90°	No	Surface Mounted	Satin Nickel
S9105DL ST/SN	12V DC	4W	280lm	6000K	>82	90°	No	Surface Mounted	Satin Nickel



LED CABINET LIGHT

S9113, S9114, S9115 DISC

CONSTRUCTION

- Plastic Housing
- Aluminium reflector
- GX53 lampholder
- Suitable for GX53 LED lamp
- Lamp not included

LED LAMP OPTIONS

- GX53/450 WW
- GX53/450 CW
- GX53/450 DL

DIMENSIONS

S9113

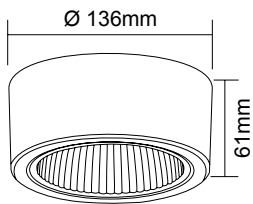

S9114

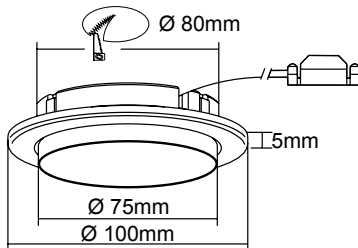

S9115

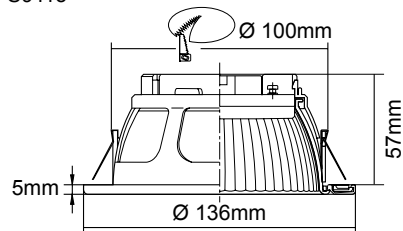

S9113



S9114



S9115

Model No.	Fitting Colour	Installation Type
S9113WH	White	Surface Mounted
S9113SL	Silver	Surface Mounted

Model No.	Fitting Colour	Installation Type
S9114SL	Silver	Recessed

Model No.	Fitting Colour	Installation Type
S9115WH	White	Recessed
S9115SL	Silver	Recessed

LED WALL LIGHT

S9511/LED, S9512/LED DESERT

CONSTRUCTION

- Pressed steel casing
- Powder coated finish (White)
- Aluminium reflector
- High efficiency SMD LED chips
- 12V AC or DC LED driver required

IP RATING

- IP20 suitable for indoor use only

SUITABLE DRIVERS

- PLUTO EGL12V/6W
- PLUTO EGL12V/15W
- PLUTO 30W/12V, PLUTO 50W/12V,
- PLUTO 100W/12V, PLUTO 200W/12V

DIMENSIONS

S9511  L 70 x W 70 mm

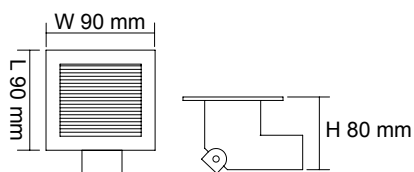

S9512  L 215 x W 70 mm

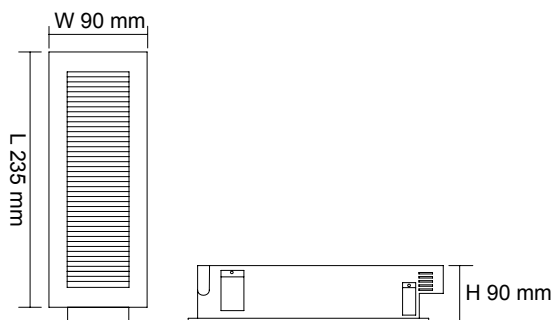

Model No.	Input	Power	Lumen	CCT	CRI	Installation Type	Fitting Colour
S9511/LED/SL	12V	3W	110lm	3000K	>80	Recessed	Silver
S9511/LED/WH	12V	3W	110lm	3000K	>80	Recessed	White
S9512/LED/SL	12V	3W	110lm	3000K	>80	Recessed	Silver
S9512/LED/WH	12V	3W	110lm	3000K	>80	Recessed	White

LED WALL LIGHT

S9515 BEACON

CONSTRUCTION

- Pressed steel body
- Powder coated finish (White)
- Aluminium reflector
- Adjustable hood 5°~85°
- High efficiency SMD LED chips
- 12V AC or DC LED driver required

IP RATING

- IP20 suitable for indoor use only

SUITABLE DRIVERS

- PLUTO EGL12V/6W
- PLUTO EGL12V/15W
- PLUTO 30W/12V, PLUTO 50W/12V,
- PLUTO 100W/12V, PLUTO 200W/12V



DIMENSIONS

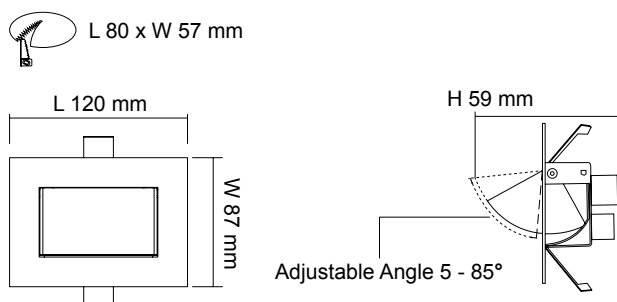

Model No.	Input	Power	Lumen	CCT	CRI	Installation Type	Fitting Colour
S9515 LED WH	12V	3W	110lm	3000K	>80	Recessed	White
S9515 LED SN	12V	3W	110lm	3000K	>80	Recessed	Satin Nickel

LED WALL LIGHT

S9316, S9317 DARHAM

CONSTRUCTION

- Premier aluminium body
- Powder coated finish (White)
- Aluminium reflector
- Opal acrylic diffuser with front glass cover
- High efficiency SMD LED chips
- 12V AC or DC driver required

IP RATING

- IP20 suitable for indoor use only

SUITABLE DRIVERS

- PLUTO EGL12V/6W
- PLUTO EGL12V/15W
- PLUTO 30W/12V, PLUTO 50W/12V,
- PLUTO 100W/12V, PLUTO 200W/12V

DIMENSIONS

S9316  Ø 60 mm

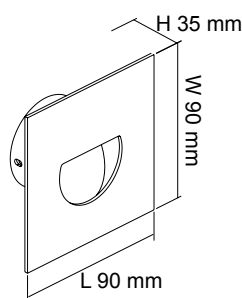

S9317  Ø 60 mm

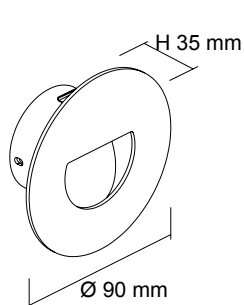

OPTIONAL ACCESSORIES FOR S9316 & S9318 ONLY

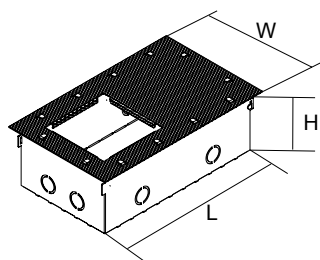

Pre-install box (S9316/8 BOX)

- L x W x H: 218 x 133 x 74 mm

Model No.	Input	Power	Lumen	CCT	CRI	Installation Type	Fitting Colour
S9316 WH	12V	1.5W	110lm	3000K	>80	Recessed	White
S9316 ALU	12V	1.5W	110lm	3000K	>80	Recessed	Anodized Silver
S9317 WH	12V	1.5W	110lm	3000K	>80	Recessed	White
S9317 ALU	12V	1.5W	110lm	3000K	>80	Recessed	Anodized Silver

LED WALL LIGHT

S9318 LEEMAN

CONSTRUCTION

- Premier aluminium body
- Frosted glass diffuser
- High efficiency SMD LED chips
- 12V AC or DC driver required

IP RATING

- IP20 suitable for indoor use only

SUITABLE DRIVERS

- PLUTO EGL12V/6W
- PLUTO EGL12V/15W
- PLUTO 30W/12V, PLUTO 50W/12V,
- PLUTO 100W/12V, PLUTO 200W/12V

DIMENSIONS

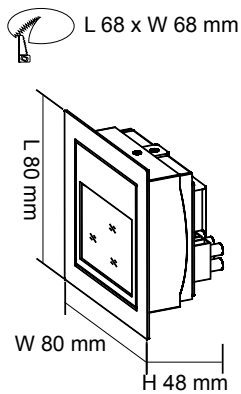

OPTIONAL ACCESSORIES FOR S9316 & S9318 ONLY

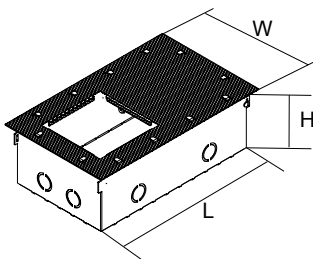

Pre-install box (S9316/8 BOX)

- L x W x H: 218 x 133 x 74 mm

Model No.	Input	Power	Lumen	CCT	CRI	Beam Angle	Installation Type	Fitting Colour
S9318 AS	12V	1.5W	70lm	3000K	>80	86°	Recessed	Anodized Silver
S9318 MW	12V	1.5W	70lm	3000K	>80	86°	Recessed	Matt White

LED WALL LIGHT

S9311 BROOM

CONSTRUCTION

- Die cast aluminium body
- Powder coated finish (White)
- Opal acrylic diffuser
- High efficiency SMD LED chips
- 12V AC or DC driver required

IP RATING

- IP20 suitable for indoor use only

SUITABLE DRIVERS

- PLUTO EGL12V/6W
- PLUTO EGL12V/15W
- PLUTO 30W/12V, PLUTO 50W/12V,
- PLUTO 100W/12V, PLUTO 200W/12V



DIMENSIONS

 L 76 x W 76 mm

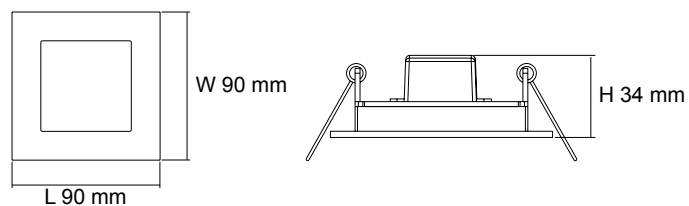

Model No.	Input	Power	Lumen	CCT	CRI	Beam Angle	Installation Type	Fitting Colour
S9311 WH	12V	3W	110lm	3000K	>80	105°	Recessed	White
S9311 SN	12V	3W	110lm	3000K	>80	105°	Recessed	Satin Nickel

LED WALL LIGHT

S9327, S9328 LOUNGE I & II

CONSTRUCTION

- Aluminium body
- High efficiency COB chip (S9327)
- High efficiency SMD chips (S9328)
- Constant current LED driver fitted

IP RATING

- IP20 suitable for indoor use only

DIMENSIONS

S9327

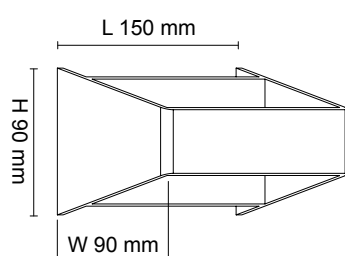

S9328

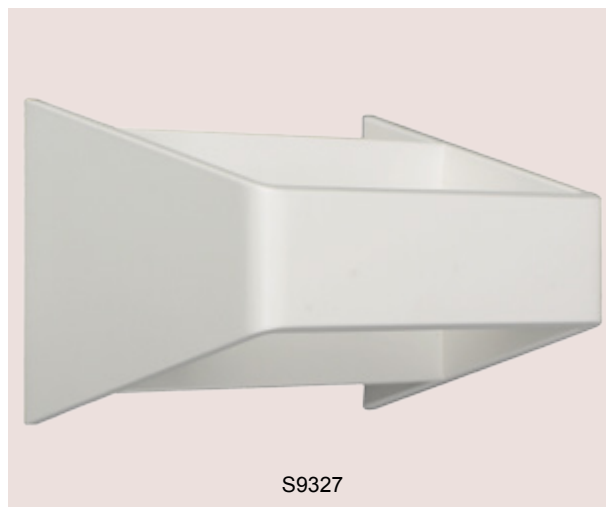
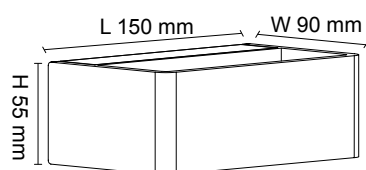

Model No.	Input	Power	Lumen	CCT	CRI	Installation Type	Fitting Colour
S9327	240V	4W	200lm	3000K	>80	Surface Mounted	White

Model No.	Input	Power	Lumen	CCT	CRI	Installation Type	Fitting Colour
S9328	240V	9W	450lm	3000K	>80	Surface Mounted	White

LED WALL LIGHT

S9320 CUBE

CONSTRUCTION

- Aluminium body
- Powder coated finish
- Built-in high output LED chips
- Up & Down beam angle adjustable from 0° to 60°
- Constant current LED driver fitted

IP RATING

- IP20 suitable for indoor use only

DIMENSIONS

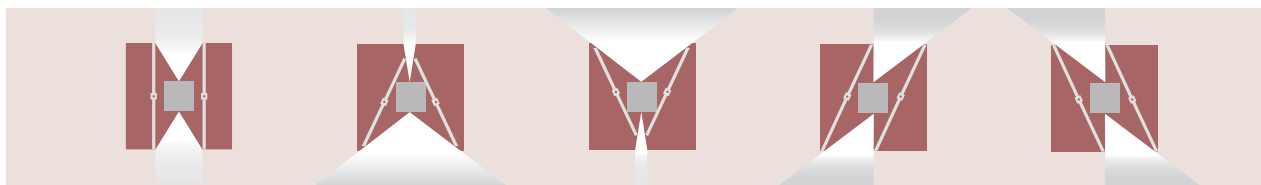
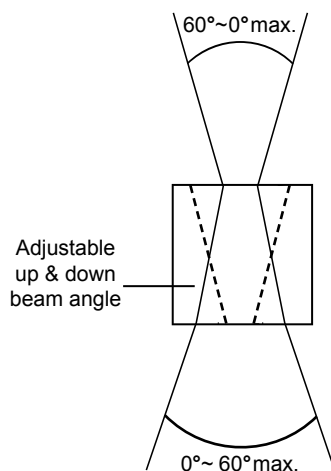
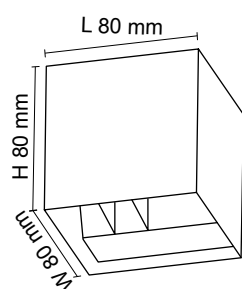

Model No.	Input	Power	Lumen	CCT	CRI	Beam Angle	Fitting Colour
S9320	240V	2W	160lm	3000K	>80	0° ~ 60°	White

LED WALL LIGHT

S9356 UD

CONSTRUCTION

- Aluminium body
- Powder coated finish
- High efficiency SMD LED chips
- Up & Down beam angle adjustable from 0° to 120°
- Constant current LED driver fitted

IP RATING

- IP20 suitable for indoor use only

DIMENSIONS

S9356/160

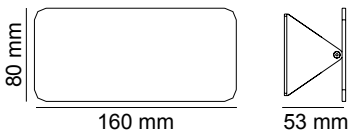

S9356/610

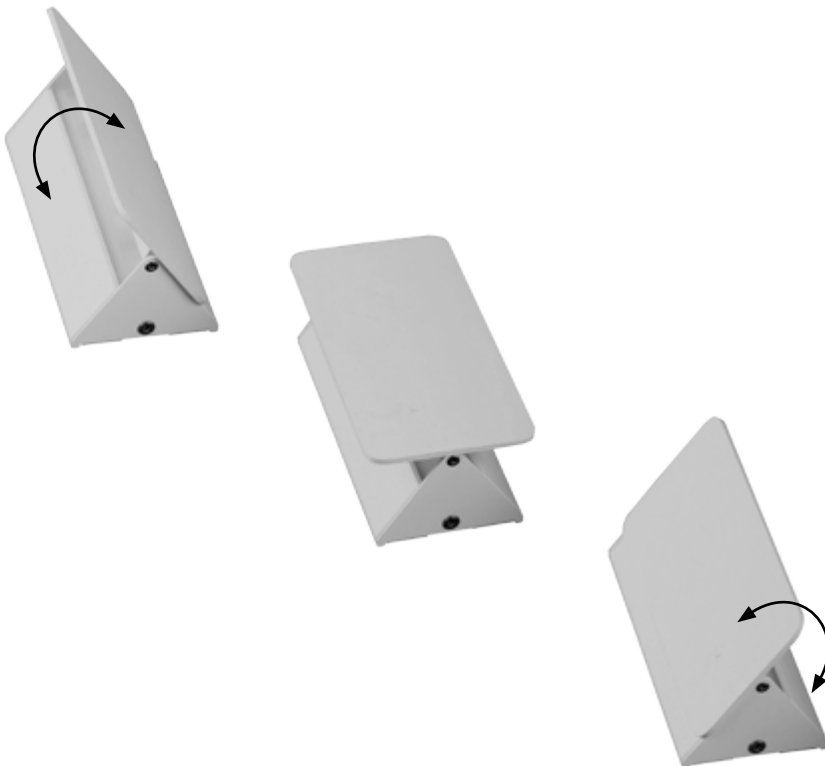
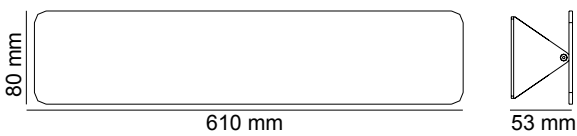

Model No.	Input	Power	Lumen	CCT	CRI	Beam Angle	Fitting Colour
S9356/160WW/WH	240V	3W	250lm	3000K	>80	0° ~ 120°	White
S9356/610WW/WH	240V	12W	800lm	3000K	>80	0° ~ 120°	White

Specifications above are for reference only and may vary without prior notice



LED LINEAR & PROFILES





STB/106, STB/206, STB/112, STB/212 TUBELINE	89
STB/206EM2500, STB/212EM2500 TUBELINE	90
STD/106, STD/206, STD/112, STD/212 TUBELINE	91
STD/206EM2500, STD/212EM2500 TUBELINE	92
STG/106, STG/206, STG/112, STG/212 TUBELINE	93
STG/206EM2500, STG/212EM2500 TUBELINE	94
SLD2000, SLD4000 LEDLINE	95
S9733 WIDELINE T8	97
S9733L WIDELINE LED	99
SL3147/306, SL3147/312 FLORIO	100
SL9706 SEAMLESS SLIMLINE	101
S9775 PHOENIX	103
SL9707 BLADE	105
SL9709 BLADE	106

LED BARE BATTEN

STB/106, STB/206, STB/112, STB/212 TUBELINE

CONSTRUCTION

- Pressed steel base with PVC housing
- Powder coated finish
- High efficiency LED T8 tubes fitted
- Large terminal block, easy installation
- Safety fuse installed

APPLICATIONS

- Offices
- Stations
- Garages
- Industrial

DIMENSIONS

STB/112

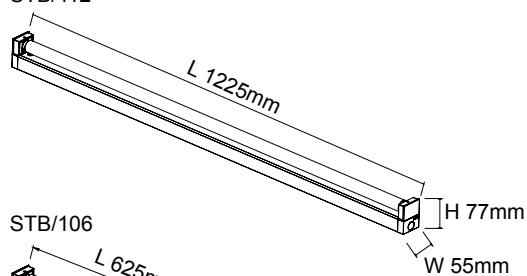

STB/106

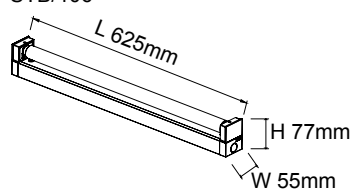

STB/212

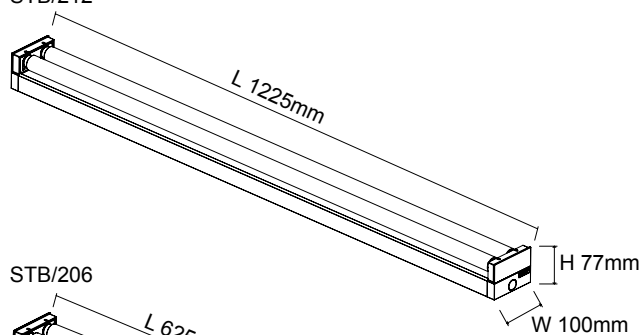

STB/206

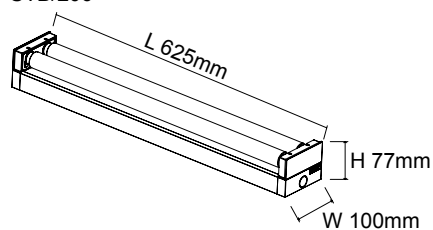

STB/112



STB/106



STB/212



STB/206

Model No.	Input	Power	Lumen	CCT	CRI	Beam Angle	Fitting Colour
STB/106 WW	240V	9W	800lm	3000K	>80	120°	White
STB/112 WW	240V	18W	1500lm	3000K	>80	120°	White

Model No.	Input	Power	Lumen	CCT	CRI	Beam Angle	Fitting Colour
STB/106 CW	240V	9W	850lm	4000K	>80	120°	White
STB/112 CW	240V	18W	1600lm	4000K	>80	120°	White

Model No.	Input	Power	Lumen	CCT	CRI	Beam Angle	Fitting Colour
STB/106 DL	240V	9W	900lm	6000K	>80	120°	White
STB/112 DL	240V	18W	1700lm	6000K	>80	120°	White

Model No.	Input	Power	Lumen	CCT	CRI	Beam Angle	Fitting Colour
STB/206 WW	240V	18W	1600lm	3000K	>80	120°	White
STB/212 WW	240V	36W	3000lm	3000K	>80	120°	White

Model No.	Input	Power	Lumen	CCT	CRI	Beam Angle	Fitting Colour
STB/206 CW	240V	18W	1650lm	4000K	>80	120°	White
STB/212 CW	240V	36W	3200lm	4000K	>80	120°	White

Model No.	Input	Power	Lumen	CCT	CRI	Beam Angle	Fitting Colour
STB/206 DL	240V	18W	1700lm	6000K	>80	120°	White
STB/212 DL	240V	36W	3400lm	6000K	>80	120°	White

PHOTOMETRIC DATA

Unit: cd

STB/106CW C0/C180 ———
C90/C270 ———

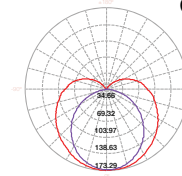

STB/112 CW

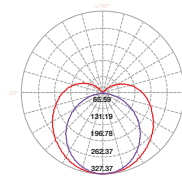

STB/206 CW

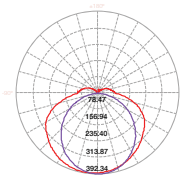

STB/212 CW

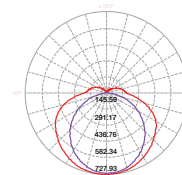

EMERGENCY LED BARE BATTEN STB/206EM2500, STB/212EM2500 TUBELINE

EMERGENCY

- Compliant to AS2293
- Emergency classification:
 - » D32@C0,C180
 - » D20@C90, C270
- LED charge status indicator
- Test switch with self-test function
- 3 hours emergency operation
- Intelligent automatic recharging function
- 16 hours charge time
- Deep discharge protection
- SELV classified
- Non-maintained emergency



Model No.	Input	Power	Lumen	CCT	CRI	Beam Angle	Battery Capacity	Battery Voltage	Fitting Colour
STB/206EM2500	240V	18W/3W	1800lm/200lm	6000K	>80	120°	2500mAh	4.8V	White
STB/212EM2500	240V	36W/3W	3600lm/200lm	6000K	>80	120°	2500mAh	4.8V	White



www.sal.net.au

LED DIFFUSED BATTEN

STD/106, STD/206, STD/112, STD/212 TUBELINE

CONSTRUCTION

- Pressed steel base with PVC housing
- Powder coated finish
- High efficiency LED T8 tubes fitted
- Opal PMMA diffuser, even light output
- Large terminal block, easy installation
- Safety fuse installed

APPLICATIONS

- Offices
- Stations
- Garages
- Industrial

DIMENSIONS

STD/112

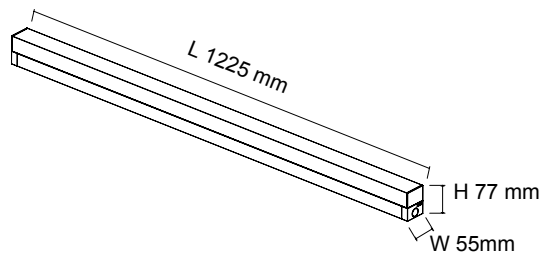

STD/106

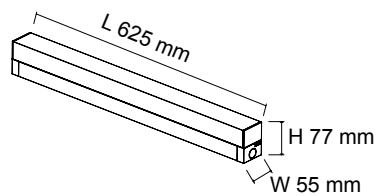

STD/212

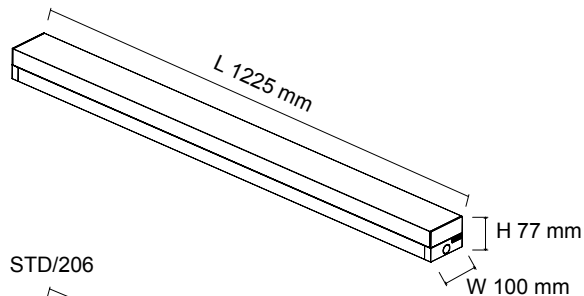

STD/206

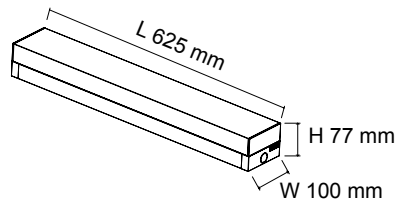

STD/112



STD/106



STD/212



STD/206

Model No.	Input	Power	Lumen	CCT	CRI	Beam Angle	Fitting Colour
STD/106 WW	240V	9W	650lm	3000K	>80	120°	White
STD/112 WW	240V	18W	1300lm	3000K	>80	120°	White

Model No.	Input	Power	Lumen	CCT	CRI	Beam Angle	Fitting Colour
STD/106 CW	240V	9W	700lm	4000K	>80	120°	White
STD/112 CW	240V	18W	1400lm	4000K	>80	120°	White

Model No.	Input	Power	Lumen	CCT	CRI	Beam Angle	Fitting Colour
STD/106 DL	240V	9W	750lm	6000K	>80	120°	White
STD/112 DL	240V	18W	1500lm	6000K	>80	120°	White

Model No.	Input	Power	Lumen	CCT	CRI	Beam Angle	Fitting Colour
STD/206 WW	240V	18W	1300lm	3000K	>80	120°	White
STD/212 WW	240V	36W	2600lm	3000K	>80	120°	White

Model No.	Input	Power	Lumen	CCT	CRI	Beam Angle	Fitting Colour
STD/206 CW	240V	18W	1400lm	4000K	>80	120°	White
STD/212 CW	240V	36W	2800lm	4000K	>80	120°	White

Model No.	Input	Power	Lumen	CCT	CRI	Beam Angle	Fitting Colour
STD/206 DL	240V	18W	1500lm	6000K	>80	120°	White
STD/212 DL	240V	36W	3000lm	6000K	>80	120°	White

PHOTOMETRIC DATA

Unit: cd

STD/106CW C0/C180 ———
C90/C270 ———

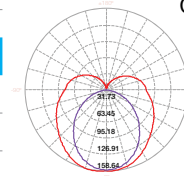

STD/112 CW

STD/206 CW

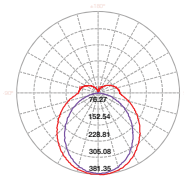
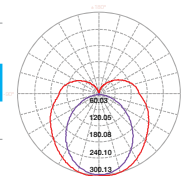

STD/212 CW

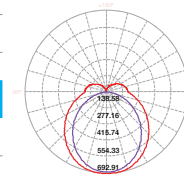

EMERGENCY LED DIFFUSED BATTEN STD/206EM2500, STD/212EM2500 TUBELINE

EMERGENCY

- Compliant to AS2293
- Emergency classification:
 - » D32@C0,C180
 - » D20@C90, C270
- LED charge status indicator
- Test switch with self-test function
- 3 hours emergency operation
- Intelligent automatic recharging function
- 16 hours charge time
- Deep discharge protection
- SELV classified
- Non-maintained emergency



Model No.	Input	Power	Lumen	CCT	CRI	Beam Angle	Battery Capacity	Battery Voltage	Fitting Colour
STD/206EM2500	240V	18W/3W	1500lm/200lm	6000K	>80	120°	2500mAh	4.8V	White
STD/212EM2500	240V	36W/3W	3000lm/200lm	6000K	>80	120°	2500mAh	4.8V	White



LED WIRE GUARD BATTEN

STG/106, STG/206, STG/112, STG/212 TUBELINE

CONSTRUCTION

- Pressed steel base with PVC housing
- Powder coated finish
- High efficiency LED T8 tubes fitted
- Powder coated steel wire guard
- Large terminal block, easy installation
- Safety fuse installed

APPLICATIONS

- Offices
- Stations
- Garages
- Industrial

DIMENSIONS (Refer to Page 95)

STB

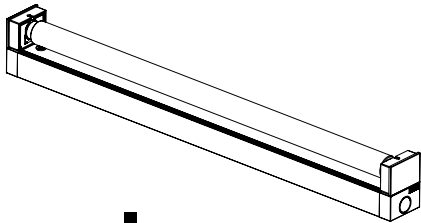

STW

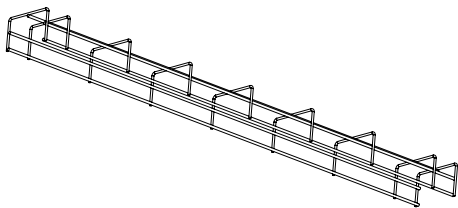

STG

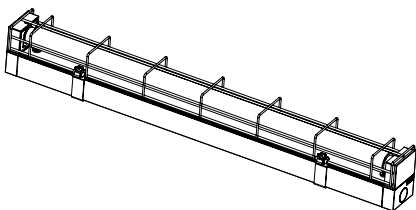

STG/112



STG/106



STG/212



STG/206

Model No.	Input	Power	Lumen	CCT	CRI	Beam Angle	Fitting Colour
STG/106 WW	240V	9W	800lm	3000K	>80	120°	White
STG/112 WW	240V	18W	1700lm	3000K	>80	120°	White

Model No.	Input	Power	Lumen	CCT	CRI	Beam Angle	Fitting Colour
STG/106 CW	240V	9W	850lm	4000K	>80	120°	White
STG/112 CW	240V	18W	1750lm	4000K	>80	120°	White

Model No.	Input	Power	Lumen	CCT	CRI	Beam Angle	Fitting Colour
STG/106 DL	240V	9W	900lm	6000K	>80	120°	White
STG/112 DL	240V	18W	1800lm	6000K	>80	120°	White

Model No.	Input	Power	Lumen	CCT	CRI	Beam Angle	Fitting Colour
STG/206 WW	240V	18W	1600lm	3000K	>80	120°	White
STG/212 WW	240V	36W	3400lm	3000K	>80	120°	White

Model No.	Input	Power	Lumen	CCT	CRI	Beam Angle	Fitting Colour
STG/206 CW	240V	18W	1700lm	4000K	>80	120°	White
STG/212 CW	240V	36W	3500lm	4000K	>80	120°	White

Model No.	Input	Power	Lumen	CCT	CRI	Beam Angle	Fitting Colour
STG/206 DL	240V	18W	1800lm	6000K	>80	120°	White
STG/212 DL	240V	36W	3600lm	6000K	>80	120°	White

PHOTOMETRIC DATA

Unit: cd

STG/106CW C0/C180 ———
C90/C270 ———

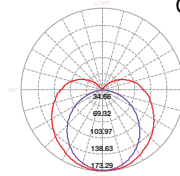

STG/112 CW

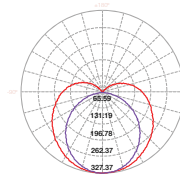

STG/206 CW

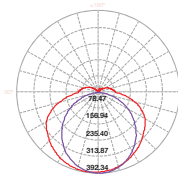

STG/212 CW

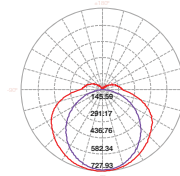

EMERGENCY LED WIRE GUARD BATTEN STG/206EM2500, STG/212EM2500 TUBELINE

EMERGENCY

- Compliant to AS2293
- Emergency classification:
 - » D32@C0,C180
 - » D20@C90, C270
- LED charge status indicator
- Test switch with self-test function
- 3 hours emergency operation
- Intelligent automatic recharging function
- 16 hours charge time
- Deep discharge protection
- SELV classified
- Non-maintained emergency



Model No.	Input	Power	Lumen	CCT	CRI	Beam Angle	Battery Capacity	Battery Voltage	Fitting Colour
STG/206EM2500	240V	18W/3W	1800lm/200lm	6000K	>80	120°	2500mAh	4.8V	White
STG/212EM2500	240V	36W/3W	3600lm/200lm	6000K	>80	120°	2500mAh	4.8V	White

LED DIFFUSED BATTEN

SLD2000, SLD4000 LEDLINE



CONSTRUCTION

- Pressed steel body
- Powder coated finish
- Opal PMMA diffuser
- High efficiency SMD LED chips
- Constant current LED driver fitted
- Large terminal block, easy installation
- Unique diffuser fixing allows end to end installation

IP RATING

- IP20 suitable for indoor use only

COLOUR TEMPERATURE

- 4000K COOL WHITE

DIMMING OPTIONS

- Analogue (Trailing edge, 1-10V)
- Digital dimming (DSI, DALI)

EMERGENCY OPTIONS

- Compliant to AS2293

DIMENSIONS

SLD2000

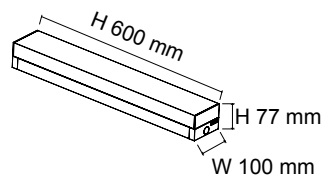

SLD4000

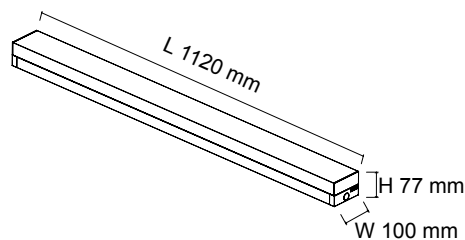

Model No.	Input	Power	Lumen	CCT	CRI	Beam Angle	Dimmable	Fitting Colour
SLD2000CW	240V	20W	1900lm	4000K	>80	120°	No	White
SLD4000CW	240V	40W	3800lm	4000K	>80	120°	No	White



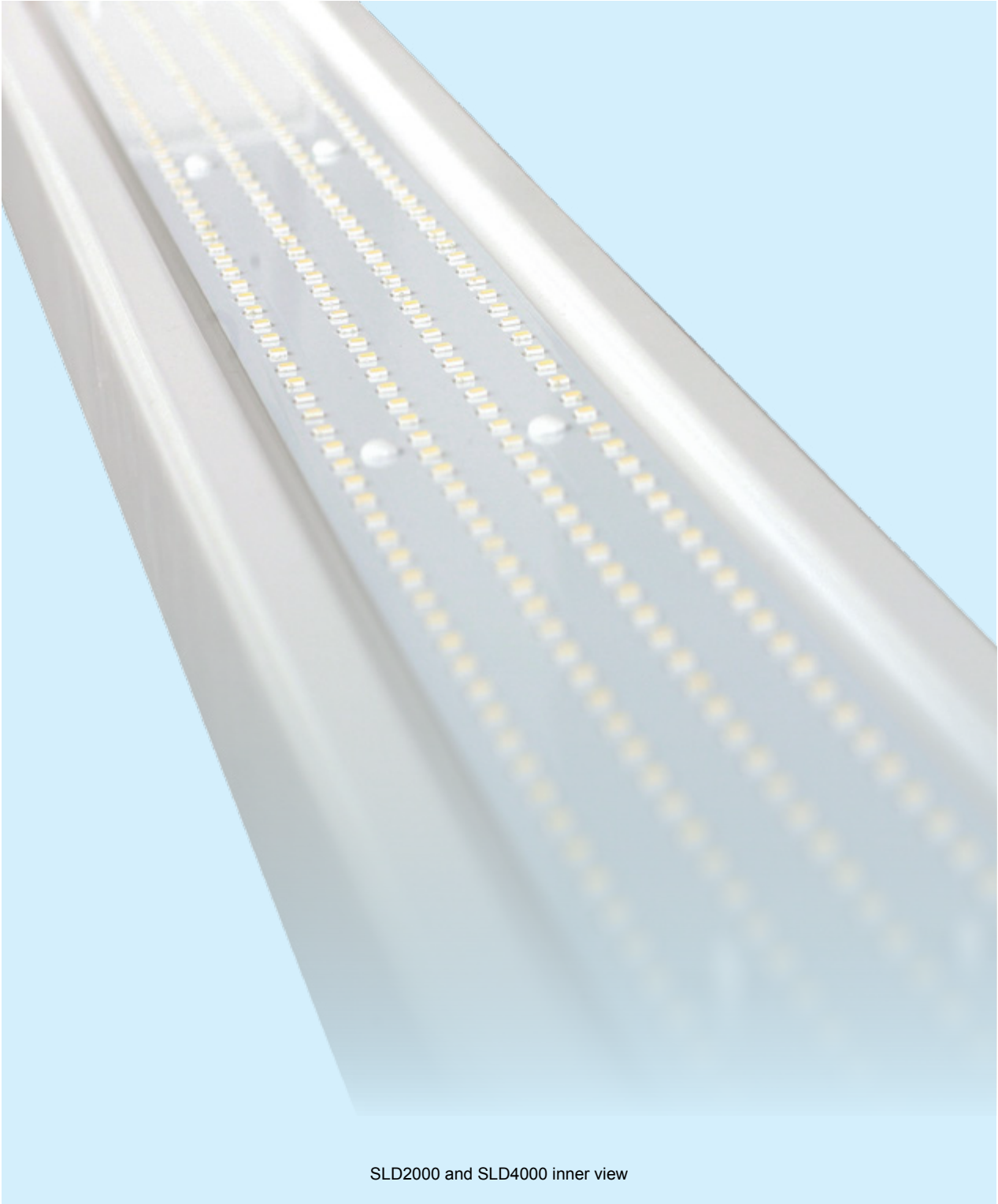

SLD2000 and SLD4000 inner view

LED DIFFUSED BATTEN

S9733 WIDELINE T8



CONSTRUCTION

- Wide steel body
- Powder coated finish
- Opal polycarbonate diffuser
- High efficiency LED T8 tubes fitted
- Large terminal block installed
- Safety fuse installed

APPLICATIONS

- Offices
- Stations
- Garages
- Industrial

IP RATING

- IP20 suitable for indoor use only

DIMENSIONS

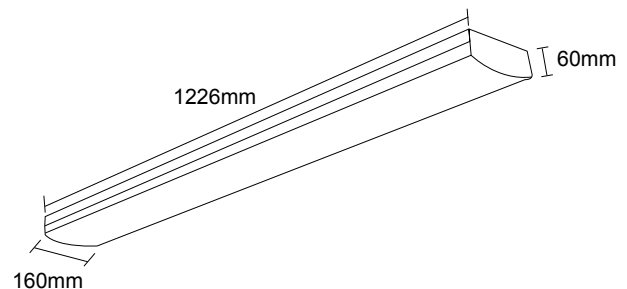

Model No.	Input	Power	Lumen	Beam Angle	CCT	CRI	Dimmable	Fitting Colour
S9733/212CW	240V	36W	2800lm	120°	4000K	>80	No	White
S9733/212DL	240V	36W	3000lm	120°	6000K	>80	No	White



LED DIFFUSED BATTEN

S9733L WIDELINE LED



CONSTRUCTION

- Wide steel body
- Powder coated finish
- Opal polycarbonate diffuser
- High efficiency SMD LED chips
- Constant current LED driver fitted
- Large terminal block installed

APPLICATIONS

- Offices
- Stations
- Garages
- Industrial

IP RATING

- IP20 suitable for indoor use only

DIMMING OPTIONS

- Analogue (Trailing edge, 1-10V)
- Digital dimming (DSI, DALI)

DIMENSIONS

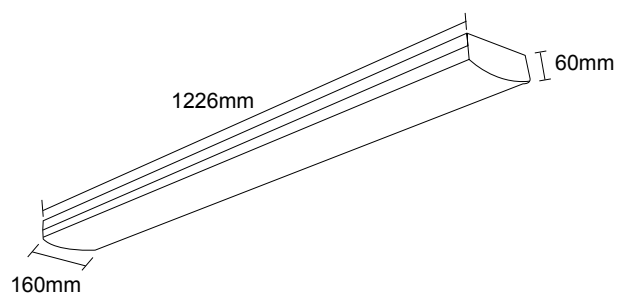

Model No.	Input	Power	Lumen	Beam Angle	CCT	CRI	Dimmable	Fitting Colour
S9733L/212CW	240V	36W	3600lm	120°	4000K	>80	No	White
S9733L/212DL	240V	36W	3700lm	120°	5700K	>80	No	White

LED LINEAR FITTING

SL3147/306, SL3147/312 FLORIO

CONSTRUCTION

- Extruded aluminium frame
- Powder coated steel base
- Opal polystyrene diffuser
- High efficiency SMD LED chips
- Constant current LED driver fitted

INSTALLATION TYPE

- Surface mounted
- Suspension unit required (SSI1512 or SSY1512)

DIMMING OPTIONS

- Trailing edge dimming
- Analogue dimming (1-10V dimming)
- Digital dimming (DSI, DALI)

DIMENSIONS

SL3147/306

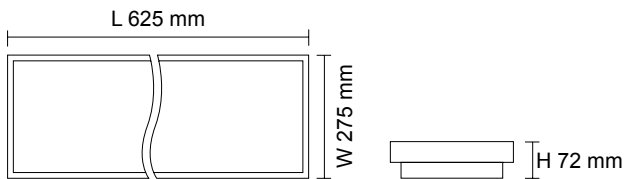

SL3147/312

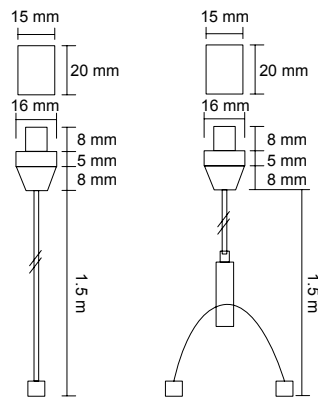
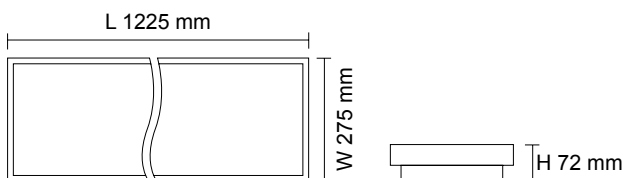

SSI1512 "I" CONNECTION SSY1512 "Y" CONNECTION



Suspension wire unit

Model No.	Input	Power	Lumen	CCT	CRI	Beam Angle	Fitting Colour
SL3147/306 CW	240V	21W	1400lm	4000K	>80	110°	Silver
SL3147/312 CW	240V	41W	2800lm	4000K	>80	110°	Silver

LINKABLE LED LINEAR FITTING

SL9706 SEAMLESS SLIMLINE

CONSTRUCTION

- Double insulated polycarbonate body
- Opal polycarbonate diffuser
- High efficiency SMD LED chips
- Built-in LED driver
- 1.2 m flex & plug
- Mounting brackets and connectors (Straight & 10 cm flexible) included

IP RATING

- IP20 suitable for indoor use only

APPLICATIONS

- Shops
- Shelves
- Cabinets

ACCESSORIES

- SL9706/32CM LINK
- SL9706/76CM LINK

MAXIMUM CONNECTIONS

Mixed connections maximum 240W

SL9706/280	1	2	3	4...	55pcs
SL9706/540	1	2	3	4...	25pcs
SL9706/840	1	2	3	4...	17pcs
SL9706/1140	1	2	3	4...	12pcs
SL9706/1440	1	2	3	4...	10pcs

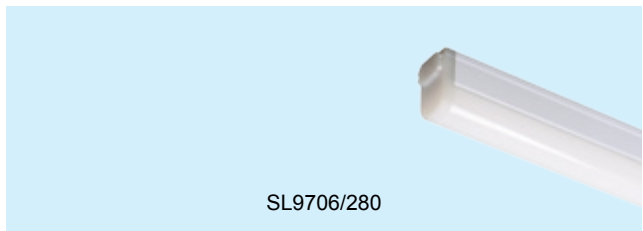

LINKABLE LED LINEAR FITTING

DIMENSIONS

SL9706/280

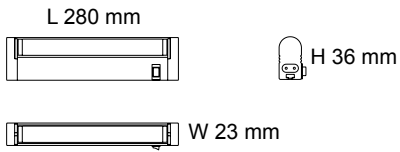

SL9706/1140

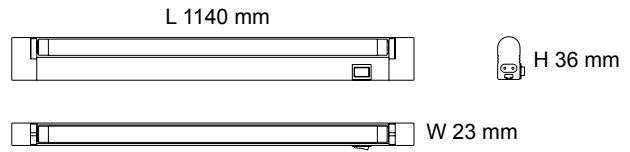

SL9706/540

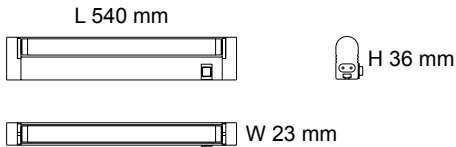

SL9706/1440

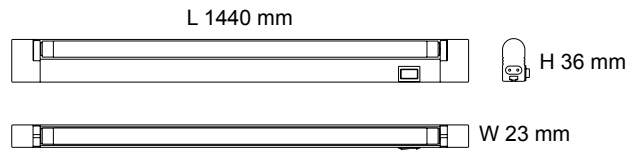

SL9706/840

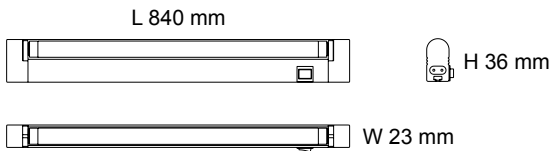

Model No.	Input	Power	Lumen	CCT	CRI	Beam Angle	Fitting Colour
SL9706/280WW/FP	240V	4W	300lm	3000K	>80	105°	White
SL9706/280CW/FP	240V	4W	380lm	4000K	>80	105°	White
SL9706/280DL/FP	240V	4W	300lm	5000K	>80	105°	White
SL9706/540WW/FP	240V	9W	750lm	3000K	>80	105°	White
SL9706/540CW/FP	240V	9W	750lm	4000K	>80	105°	White
SL9706/540DL/FP	240V	9W	750lm	5000K	>80	105°	White
SL9706/840WW/FP	240V	13W	1050lm	3000K	>80	105°	White
SL9706/840CW/FP	240V	13W	1200lm	4000K	>80	105°	White
SL9706/840DL/FP	240V	13W	1050lm	5000K	>80	105°	White
SL9706/1140WW/FP	240V	18W	1550lm	3000K	>80	105°	White
SL9706/1140CW/FP	240V	18W	1600lm	4000K	>80	105°	White
SL9706/1140DL/FP	240V	18W	1550lm	5000K	>80	105°	White
SL9706/1440WW/FP	240V	22W	1800lm	3000K	>80	105°	White
SL9706/1440CW/FP	240V	22W	2000lm	4000K	>80	105°	White
SL9706/1440DL/FP	240V	22W	1800lm	5000K	>80	105°	White

PHOTOMETRIC DATA

Unit: cd C0/C180 — C90/C270 —

SL9706/280DL

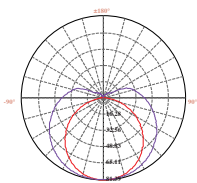

SL9706/540DL

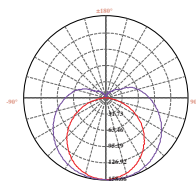

SL9706/840DL

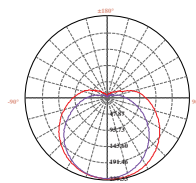

SL9706/1140DL

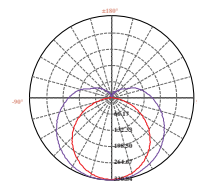

SL9706/1440DL

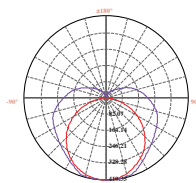

www.sal.net.au

LINKABLE LED LINEAR FITTING

S9775 PHOENIX

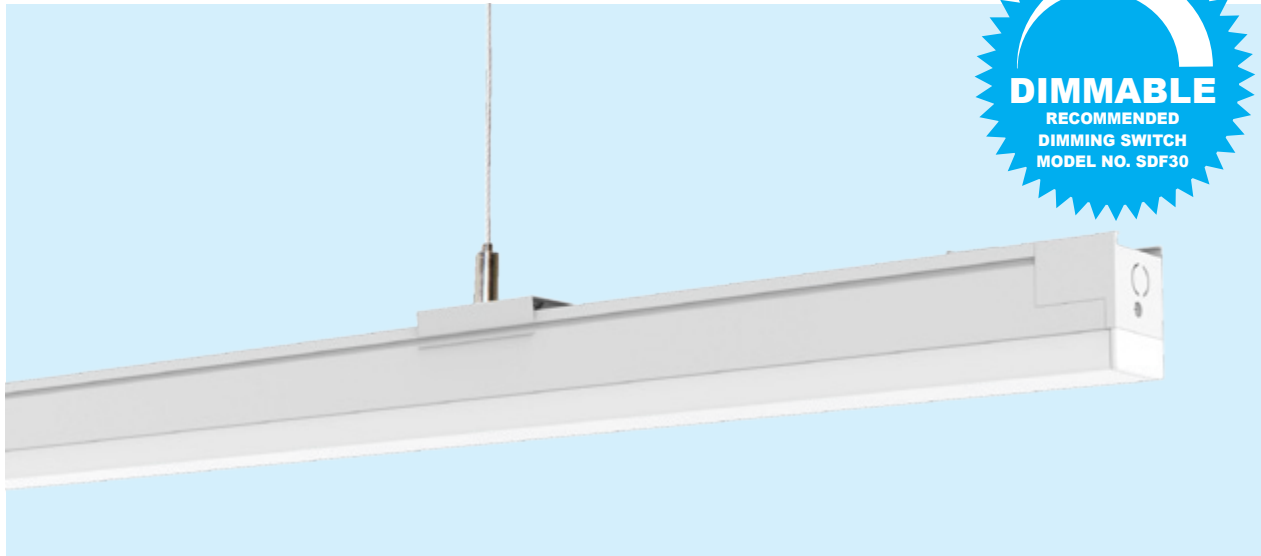

CONSTRUCTION

- Extruded aluminium profile
- Opal polycarbonate diffuser
- High efficiency SMD LED chips
- Built in 1-10V dimmable LED driver
- Surface mounted or suspended (suspension kit required)
- Two mounting clips included

ACCESSORY OPTIONS



IP RATING

- IP20 suitable for indoor use only

DIMENSIONS

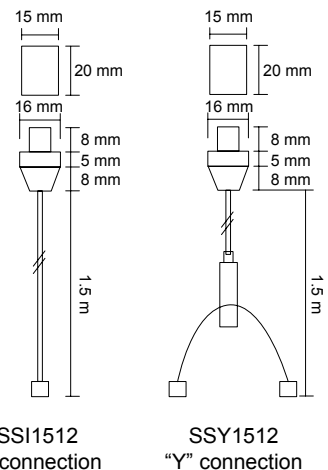
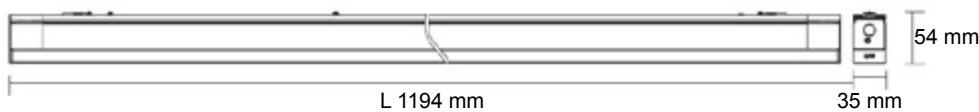

MAXIMUM CONNECTIONS

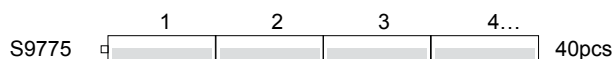

Model No.	Input	Power	Lumen	CCT	CRI	Beam Angle	Fitting Colour
S9775CW	240V	30W	2800lm	4000K	80	120°	White



LOW PROFILE LED BATTEN

SL9707 BLADE

CONSTRUCTION

- Extruded aluminium body with poly end cap
- Powder coated finish
- Opal polycarbonate diffuser
- High efficiency SMD LED chips
- Built-in LED driver

IP RATING

- IP20 suitable for indoor use only

INSTALLATION TYPE

- Surface mounted
- Suspended (Suspension unit required SSI1512, SSY1512)
- End to end installation

DIMENSIONS

SL9707/60

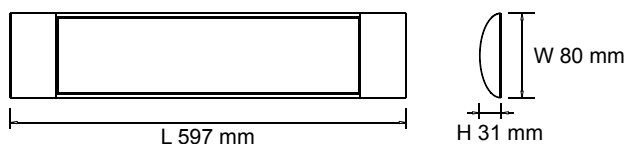

SL9707/60



SL9707/120

SL9707/120

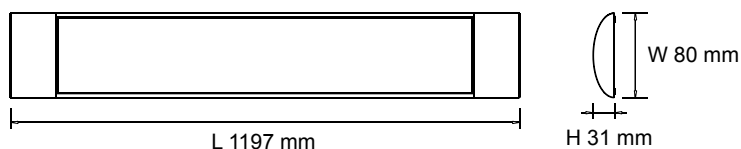

Model No.	Input	Power	Lumen	CCT	CRI	Beam Angle	Fitting Colour
SL9707/60WW	240V	20W	1800lm	3000K	>80	110°	White
SL9707/60CW	240V	20W	1850lm	4000K	>80	110°	White
SL9707/60DL	240V	20W	1900lm	5000K	>80	110°	White
SL9707/120WW	240V	35W	3300lm	3000K	>80	110°	White
SL9707/120CW	240V	35W	3400lm	4000K	>80	110°	White
SL9707/120DL	240V	35W	3500lm	5000K	>80	110°	White

PHOTOMETRIC DATA

Unit: cd C0/C180 — C90/C270 —

SL9707/60DL

SL9707/120DL

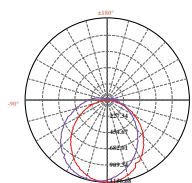
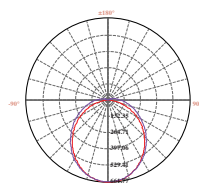

www.sal.net.au

LOW PROFILE LED BATTEN

SL9709 BLADE

CONSTRUCTION

- Extruded aluminium body with poly end cap
- Powder coated finish
- Opal polycarbonate diffuser
- High efficiency SMD LED chips
- Built-in LED driver

IP RATING

- IP20 suitable for indoor use only

INSTALLATION TYPE

- Surface mounted
- Suspended (Suspension Kit Required SSI1512, SSY1512)
- End to end installation

DIMENSIONS

SL9709/60

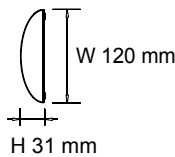
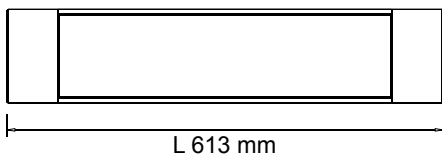

SL9709/120

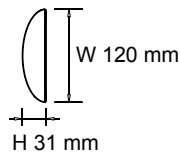
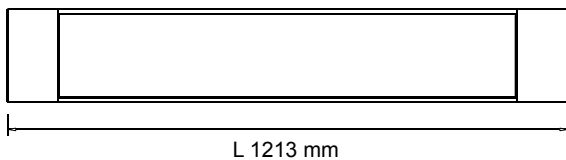

SL9709/60



SL9709/120

Model No.	Input	Power	Lumen	CCT	CRI	Beam Angle	Fitting Colour
SL9709/60WW	240V	25W	2200lm	3000K	>80	110°	White
SL9709/60CW	240V	25W	2600lm	4000K	>80	110°	White
SL9709/60DL	240V	25W	2400lm	5000K	>80	110°	White
SL9709/120WW	240V	48W	4400lm	3000K	>80	110°	White
SL9709/120CW	240V	48W	5000lm	4000K	>80	110°	White
SL9709/120DL	240V	48W	4800lm	5000K	>80	110°	White

PHOTOMETRIC DATA

Unit: cd C0/C180 — C90/C270 —

SL9709/60CW

SL9709/120CW

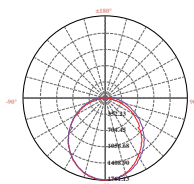
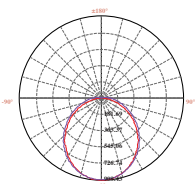



LED PANELS & TROFFERS





S9714 LED PANEL	109
S9714HO/TC HIGH OUTPUT LED PANEL COLOUR TEMPERATURE SELECTABLE	111
S9714 LOW COI HIGH CRI LED PANEL	112
S9714SM SURFACE MOUNTED FRAME	113
S9714PF RECESSED CEILING FRAME	114
S9714SP SUSPENSION UNITS	115
S9714AS LED PANEL WITH AIR SLOT FRAME	116
S9714CR LED PANEL WITH CLEAN ROOM FRAME BISMARCK	117
S9724 L-LINE T8 LED LOUVER TROFFER	119
S9734 L-LINE MKII	121
S9725 ORION	122

LED T-BAR PANEL

S9714 LED PANEL

CONSTRUCTION

- Extruded aluminium frame
- Powder coated finish
- High efficiency opal polystyrene back diffuser
- Built-in high efficiency SMD LED chips
- Constant current LED driver included
- 1.2 m flex & 2 pin plug

IP RATING

- IP20 suitable for indoor use only

DIMMING OPTIONS

- Trailing edge dimming (excluding S9714/612)
- 1-10V dimming
- Digital dimming (DSI, DALI)

INSTALLATION TYPES

- Standard metric T-Bar ceiling recessed installation
- Plaster ceiling recessed installation (S9704 Plaster ceiling frame required)
- Surface mounted installation (S306FM, S312FM, S606FM or S612FM surface mounted frame required)
- Suspended installation (SSI1512 or SSY1512 Suspension unit required)

DIMENSIONS

S9714/306

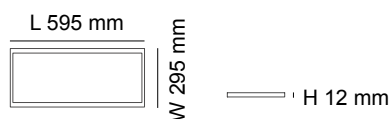

S9714/606

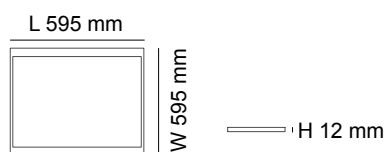

S9714/312

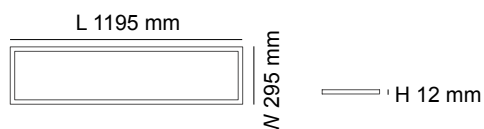

S9714/612



PHOTOMETRIC DATA

Unit: cd C0/C180 ————
 C90/C270 ————

S9714/306 WW

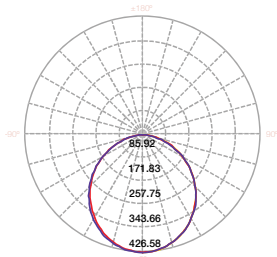

S9714/312 WW

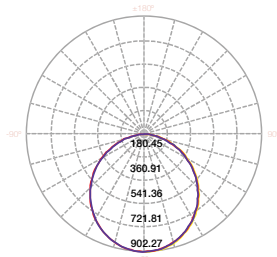

S9714/606 WW

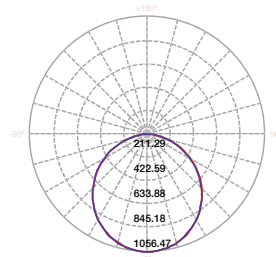

S9714/612 WW

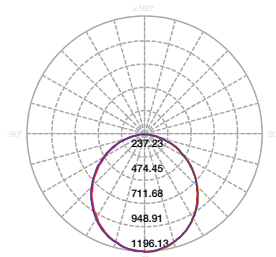

Model No.	Input	Power	Lumen	Beam Angle	CCT	CRI	Fitting Colour	Dimensions L x W x H
S9714/306 WW	240V	18W	1900lm	100°	3000K	>80	White	595 x 295 x 12 mm
S9714/306 CW	240V	18W	2000lm	100°	4000K	>80	White	595 x 295 x 12 mm
S9714/306 DL	240V	18W	2100lm	100°	6000K	>80	White	595 x 295 x 12 mm
S9714/606 WW	240V	30W	3100lm	100°	3000K	>80	White	595 x 595 x 12 mm
S9714/606 CW	240V	30W	3200lm	100°	4000K	>80	White	595 x 595 x 12 mm
S9714/606 DL	240V	30W	3300lm	100°	6000K	>80	White	595 x 595 x 12 mm
S9714/312 WW	240V	30W	3100lm	100°	3000K	>80	White	1195 x 295 x 12 mm
S9714/312 CW	240V	30W	3200lm	100°	4000K	>80	White	1195 x 295 x 12 mm
S9714/312 DL	240V	30W	3300lm	100°	6000K	>80	White	1195 x 295 x 12 mm
S9714/612 WW	240V	48W	5000lm	100°	3000K	>80	White	1195 x 595 x 12 mm
S9714/612 CW	240V	48W	5300lm	100°	4000K	>80	White	1195 x 595 x 12 mm
S9714/612 DL	240V	48W	5500lm	100°	6000K	>80	White	1195 x 595 x 12 mm

EMERGENCY

- Compliant to AS2293
- Emergency classification: D32
- LED charge status indicator
- Test switch with self-test function
- 3 hours emergency operation
- Intelligent automatic recharging function
- 16 hours charge time
- Deep discharge protection
- SELV classified



Model No.	Input	Power	Lumen	Beam Angle	CRI	Fitting Colour	Dimensions L x W x H
S9714/306EM	240V	18W/3W	2000lm/200lm	100°	>80	White	595 x 295 x 12 mm
S9714/606EM	240V	30W/3W	3200lm/200lm	100°	>80	White	595 x 595 x 12 mm
S9714/312EM	240V	30W/3W	3200lm/200lm	100°	>80	White	1195 x 295 x 12 mm
S9714/612EM	240V	48W/3W	5300lm/200lm	100°	>80	White	1195 x 595 x 12 mm

LED T-BAR PANEL

S9714HO/TC HIGH OUTPUT LED PANEL COLOUR TEMPERATURE SELECTABLE

CONSTRUCTION

- Extruded aluminium frame
- Powder coated finish
- High efficiency opal polystyrene back diffuser
- Built-in high efficiency SMD LED chips
- Constant current LED driver included
- 1.2 m flex & 2 pin plug

IP RATING

- IP20 suitable for indoor use only

DIMMING OPTIONS

- Analogue dimming (Trailing edge, 1-10V dimming)
- Digital dimming (DSI, DALI)

INSTALLATION TYPES

- Standard metric T-Bar ceiling recessed installation
- Plaster ceiling recessed installation (S9704 Plaster ceiling frame required)
- Surface mounted installation (S312FM or S606FM surface mounted frame required)
- Suspended installation (SSI1512 or SSY1512 Suspension unit required)



DIMENSIONS

S9714HO/312TC

S9714HO/606TC

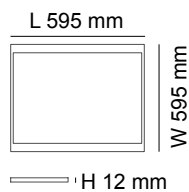
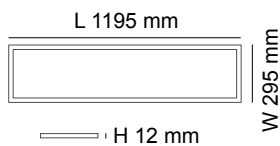

Model No.	Input	Power	Lumen	Beam Angle	CCT	CRI	Fitting Colour
S9714HO/312TC	240V	36W	3800lm	100°	3000K/4000K/5700K	>80	White
S9714HO/606TC	240V	36W	3800lm	100°	3000K/4000K/5700K	>80	White

DIAGRAM

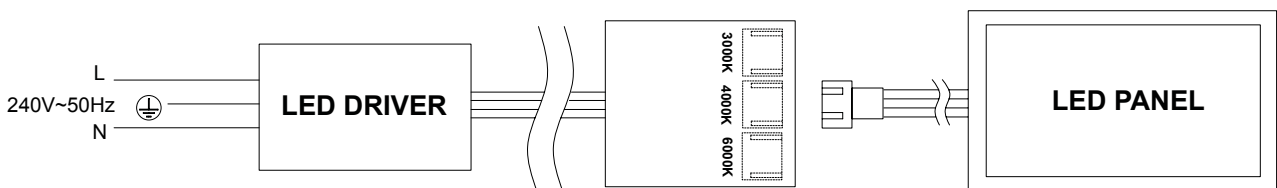

LED T-BAR PANEL

S9714 LOW COI HIGH CRI LED PANEL

SUITABLE FOR USE IN HOSPITALS & MEDICAL CENTRES
TO ACHIEVE COMPLIANCE WITH AS/NZS 1680.2.5:1997



CONSTRUCTION

- Extruded aluminium frame
- Powder coated finish
- High efficiency opal polystyrene back diffuser
- Built-in high efficiency SMD LED chips
- Constant current LED driver included
- 1.2 m flex & 2 pin plug
- Cyanosis Observation Index (COI) compliant with AS/NZS 1680.2.5:1997
- High colour rendering

IP RATING

- IP20 suitable for indoor use only

DIMMING OPTIONS (S9714/312, S9714/606)

- Analogue dimming (Trailing edge, 1-10V dimming)
- Digital dimming (DSI, DALI)

INSTALLATION TYPES

- Standard metric T-Bar ceiling recessed installation
- Plaster ceiling recessed installation (S9704 Plaster ceiling frame required)
- Surface mounted installation (S312FM, S606FM or S612FM surface mounted frame required)
- Suspended installation (SS11512 or SSY1512 Suspension unit required)



DIMENSIONS

S9714HC/312CW

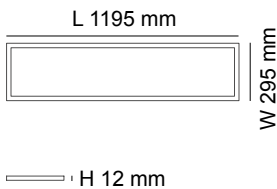

S9714HC/606CW

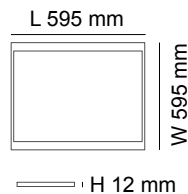

S9714HC/612CW

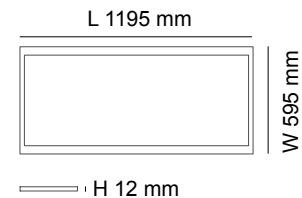

Model No.	Input	Power	Lumen	Beam Angle	CCT	COI	CRI	Fitting Colour
S9714HC/312CW	240V	40W	3000lm	100°	4000K	<1.8	>95	White
S9714HC/606CW	240V	40W	3200lm	100°	4000K	<1.8	>95	White
S9714HC/612CW	240V	58W	5000lm	100°	4000K	<1.8	>95	White

LED PANEL INSTALLATION TYPES

S9714SM SURFACE MOUNTED FRAME

CONSTRUCTION

- Pressed steel frame
- Powder coated finish

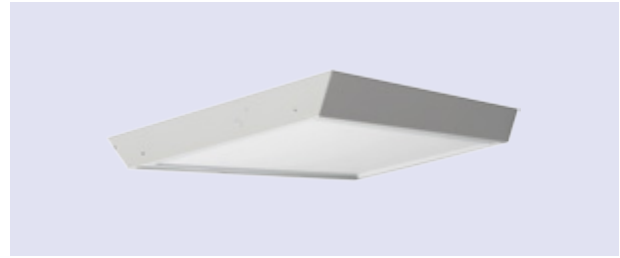

DIMENSIONS

S306FM

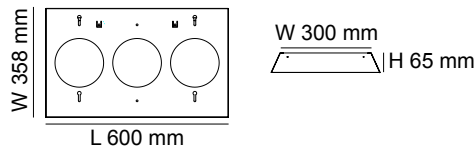

S312FM

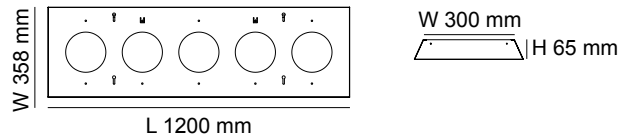

S606FM

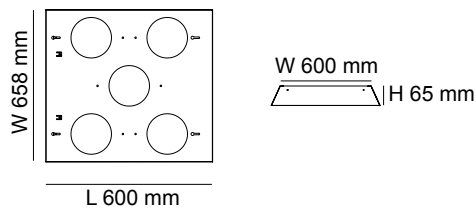

S612FM

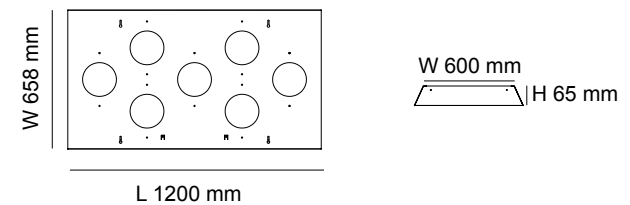

Model No.	Suitable Products	Fitting Colour
S306FM	S9714/306	White
S312FM	S9714/312, S9714HO/312TC, S9714HC/312CW	White
S606FM	S9714/606, S9714HO/606TC, S9714HC/606CW	White
S612FM	S9714/612, S9714HC/612CW	White

PANEL OPTIONS

- Refer to pages 113 to 116 of this catalogue

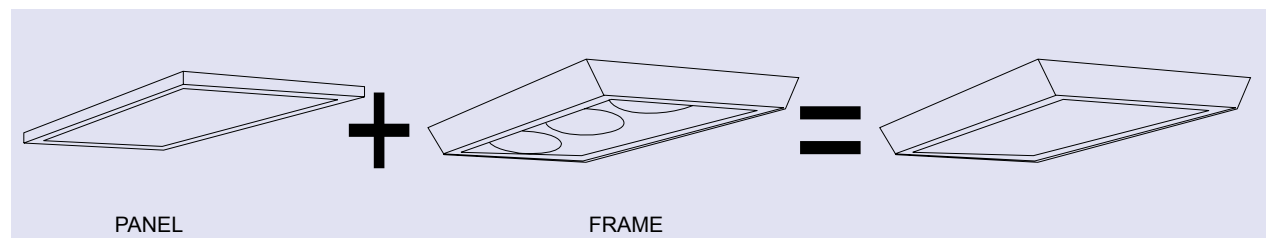

LED PANEL INSTALLATION TYPES

S9714PF RECESSED CEILING FRAME

CONSTRUCTION

- Pressed steel frame
- Powder coated finish

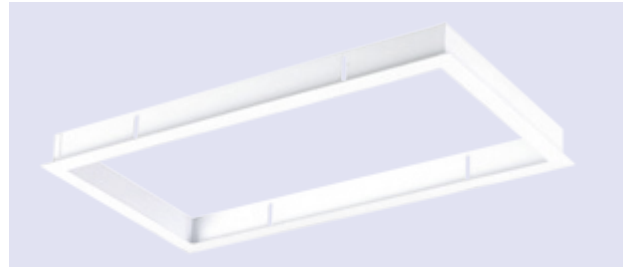

DIMENSIONS

S9704/214 FRAME

L x W: 305 x 605 mm

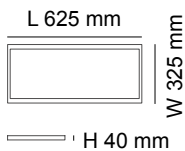

S9704/414 FRAME

L x W: 605 x 605 mm

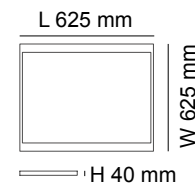

S9704/228 FRAME

L x W: 305 x 1205 mm

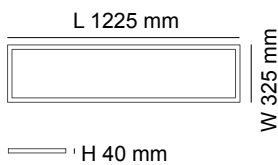

S9704/328 FRAME

L x W: 605 x 1205 mm

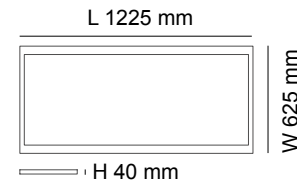

Model No.	Suitable Products	Fitting Colour
S9704/214 FRAME	S9714/306	White
S9704/414 FRAME	S9714/606, S9714HO/606TC, S9714HC/606CW	White
S9704/228 FRAME	S9714/312, S9714HO/312TC, S9714HC/312CW	White
S9704/328 FRAME	S9714/612, S9714HC/612CW	White

PANEL OPTIONS

- Refer to pages 113 to 116 of this catalogue

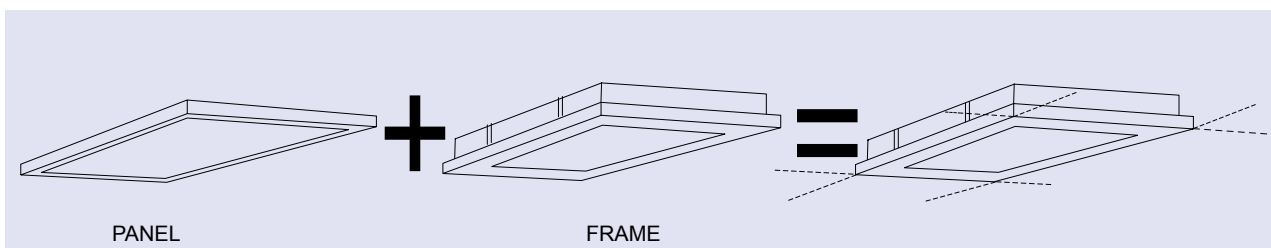

LED PANEL INSTALLATION TYPES

S9714SP SUSPENSION UNITS

CONSTRUCTION

- M10 size ceiling attachment
- 1.2 mm stainless steel cable carrying weight up to 45 kg
- M10 size griplock system

DIMENSIONS

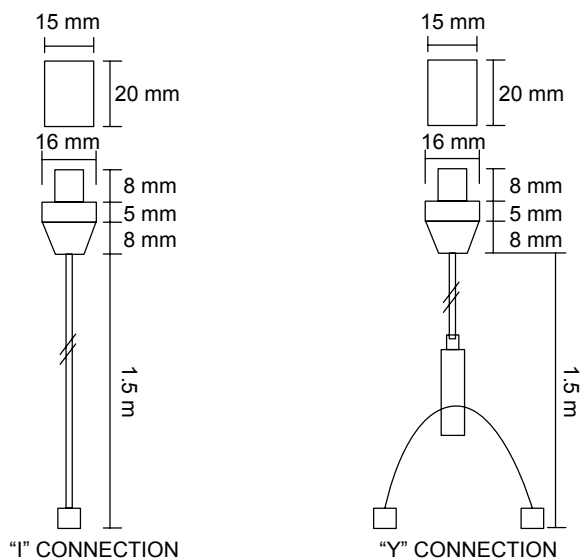

PANEL OPTIONS

- Refer to pages 113 to 116 of this catalogue

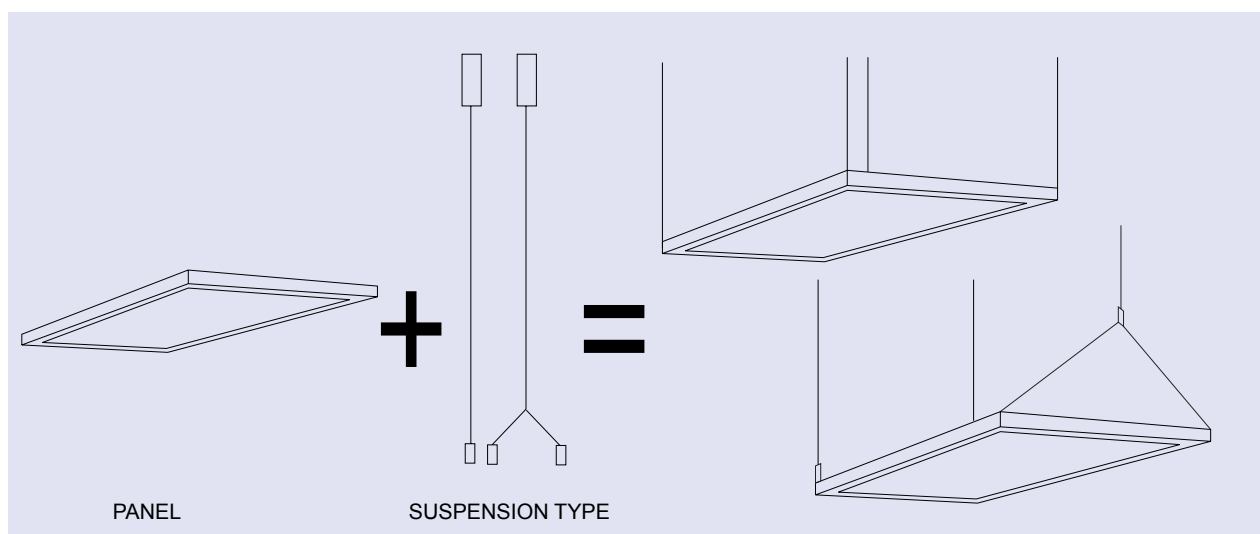

LED PANEL FRAMES

S9714AS LED PANEL WITH AIR SLOT FRAME

CONSTRUCTION

- Pressed steel frame
- Powder coated finish

DIMENSIONS

S306FMA

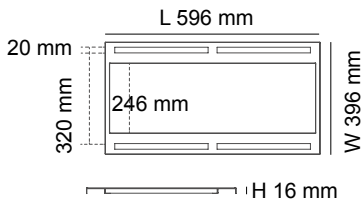

S312FMA

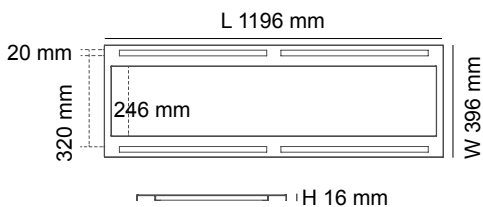

Model No.	Suitable Panels	Fitting Colour
S306FMA	S9714/306	White
S312FMA	S9714/312, S9714HO/312TC, S9714HC/312CW	White

PANEL OPTIONS

- Refer to pages 113 to 116 of this catalogue

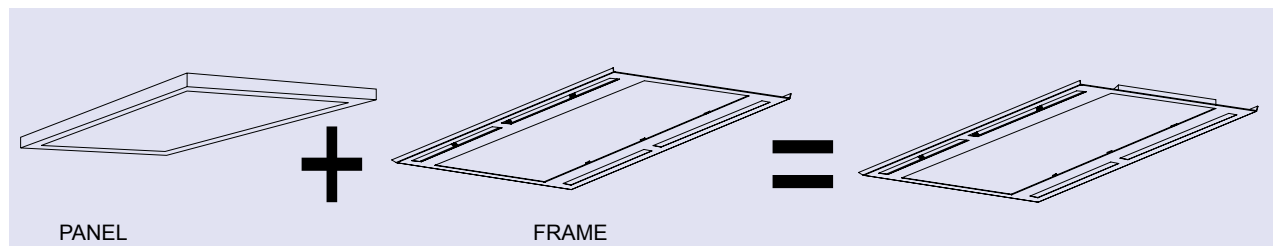

LED PANEL FRAMES

S9714CR LED PANEL WITH CLEAN ROOM FRAME BISMARCK

CONSTRUCTION

- Fully enclosed and sealed plaster troffer frame
- Adjustable flip-out mounting brackets on two sides
- Pressed steel frame
- Powder coated finish
- Purposely sealed shockproof clear polycarbonate lens
- 1.5 m flex & 3 pin plug fitted

IP RATING

- IP54 weatherproof

DIMENSIONS

S606FMCR

L x W: 636 x 636 mm

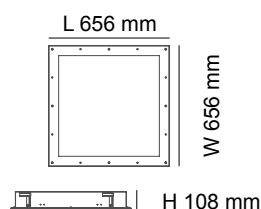

S312FMCR

L x W: 1206 x 336 mm

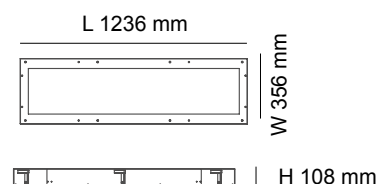

Model No.	Suitable Panels	Fitting Colour
S606FMCR	S9714/606, S9714HO/606TC, S9714HC/606CW	White
S312FMCR	S9714/312, S9714HO/312TC, S9714HC/312CW	White

PANEL OPTIONS

- Refer to pages 113 to 116 of this catalogue

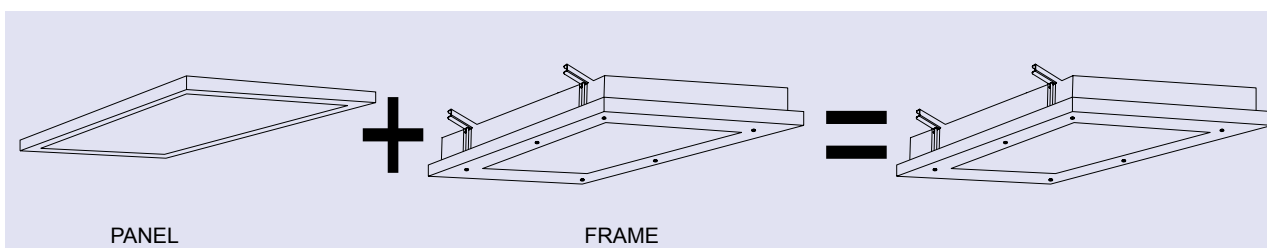



T8 LED LOW BRIGHTNESS LOUVER TROFFER

S9724 L-LINE T8 LED LOUVER TROFFER

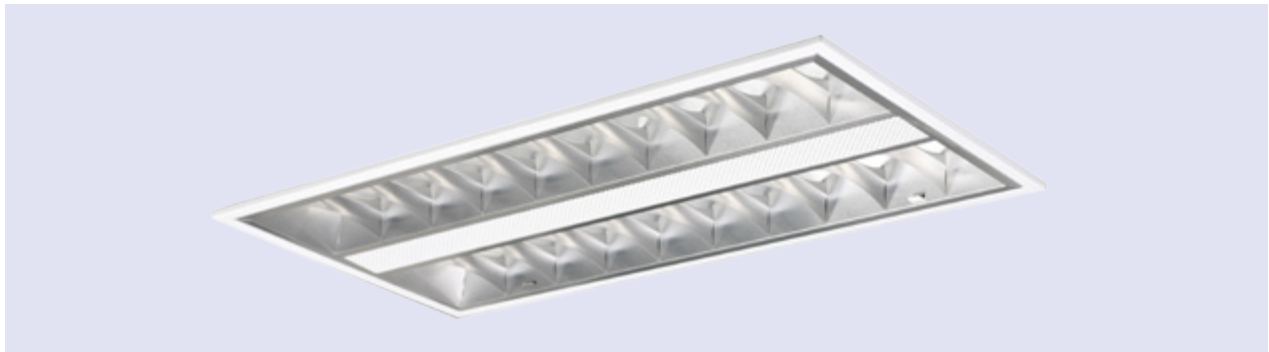

CONSTRUCTION

- Pressed steel body
- Powder coated finish
- Double parabolic matt aluminium louvre
- LED T8 tubes fitted, safety fuse installed
- 1.5 m flex & 3 pin plug

IP RATING

- IP20 suitable for indoor use only

INSTALLATION TYPE

- Standard metric T-Bar ceiling recessed installation
- Plaster ceiling recessed installation (S9704 Plaster ceiling frame required)

DIMENSIONS

S9724/306

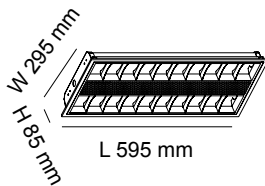

S9724/606

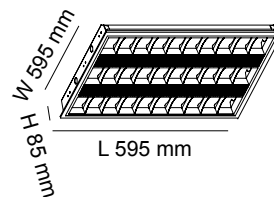

S9724/312

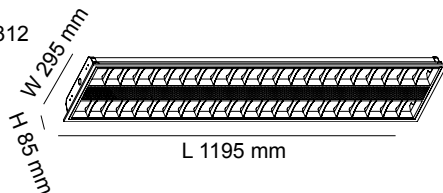

S9724/612

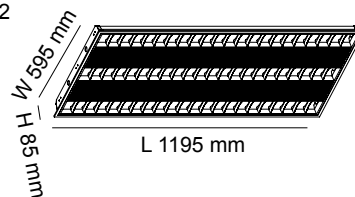

Model No.	Input	Power	Lumen	Beam Angle	CCT	CRI	Fitting Colour	No. of T8 Tubes
S9724/306WW	240V	18W	1100lm	120°	3000K	>80	White	LT8/60 x 2
S9724/306CW	240V	18W	1100lm	120°	4000K	>80	White	LT8/60 x 2
S9724/306DL	240V	18W	1100lm	120°	6000K	>80	White	LT8/60 x 2
S9724/312WW	240V	36W	2200lm	120°	3000K	>80	White	LT8/120 x 2
S9724/312CW	240V	36W	2200lm	120°	4000K	>80	White	LT8/120 x 2
S9724/312DL	240V	36W	2200lm	120°	6000K	>80	White	LT8/120 x 2
S9724/606WW	240V	27W	1800lm	120°	3000K	>80	White	LT8/60 x 3
S9724/606CW	240V	27W	1800lm	120°	4000K	>80	White	LT8/60 x 3
S9724/606DL	240V	27W	1800lm	120°	6000K	>80	White	LT8/60 x 3
S9724/612WW	240V	54W	3300lm	120°	3000K	>80	White	LT8/120 x 3
S9724/612CW	240V	54W	3300lm	120°	4000K	>80	White	LT8/120 x 3
S9724/612DL	240V	54W	3300lm	120°	6000K	>80	White	LT8/120 x 3



LED LOW BRIGHTNESS LOUVER TROFFER

S9734 L-LINE MKII



CONSTRUCTION

- Pressed steel body
- Powder coated finish
- Double parabolic matt aluminium louver
- Built-in high efficiency SMD LED chips
- Opal polycarbonate diffuser
- Constant current LED driver fitted
- 1.5 m flex & 3 pin plug

IP RATING

- IP20 suitable for indoor use only

DIMMING OPTIONS

- Trailing edge dimming (excluding S9734/612L)
- 1-10V dimming
- Digital dimming (DSI, DALI)

INSTALLATION TYPE

- Standard metric T-Bar ceiling recessed installation
- Plaster ceiling recessed installation (S9704 Plaster ceiling frame required)

DIMENSIONS

S9734/306L

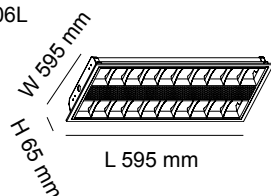

S9734/606L

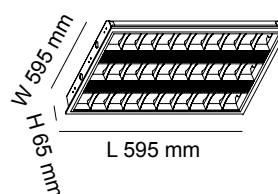

S9734/312L

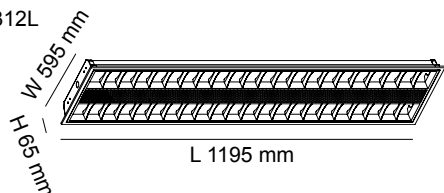

S9734/612L

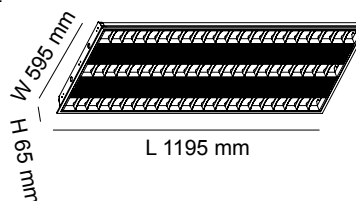

Model No.	Input	Power	Lumen	Beam Angle	CCT	CRI	Fitting Colour
S9734/306L/CW	240V	20W	1800lm	100°	4000K	>80	White
S9734/312L/CW	240V	38W	3500lm	100°	4000K	>80	White
S9734/606L/CW	240V	38W	3500lm	100°	4000K	>80	White
S9734/612L/CW	240V	55W	4800lm	100°	4000K	>80	White

LED TROFFER

S9725 ORION

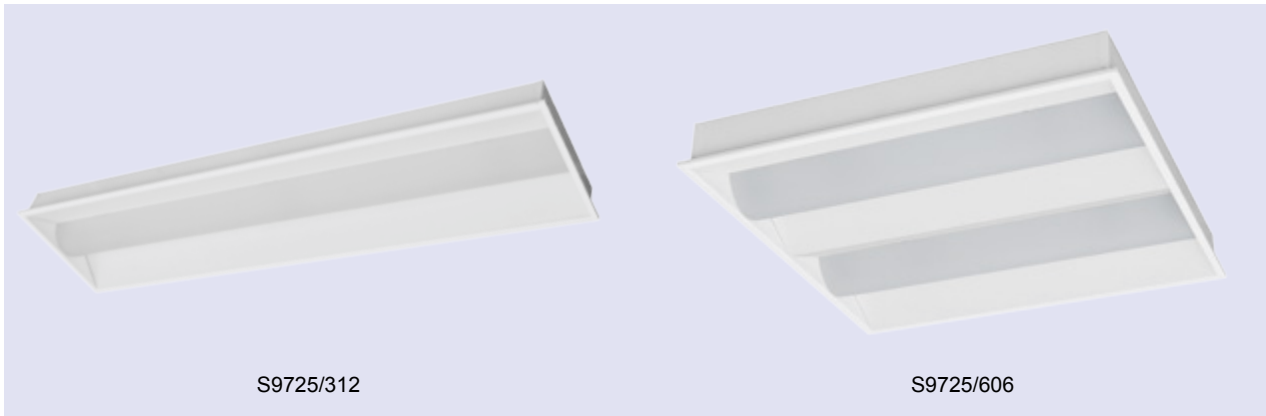

CONSTRUCTION

- Robust steel body
- Matt white powder coated finish
- Opal acrylic diffuser
- Easy access terminal block on rear
- 1.2 m flex & 2 pin plug
- Constant current LED driver fitted

IP RATING

- IP20 suitable for indoor use only

DIMMING OPTIONS

- Trailing edge dimming
- 1-10V dimming
- Digital dimming (DSI, DALI)

INSTALLATION TYPE

- Standard metric T-Bar ceiling recessed installation
- Plaster ceiling recessed installation (S9704 Plaster ceiling frame required)

DIMENSIONS

S9725/312

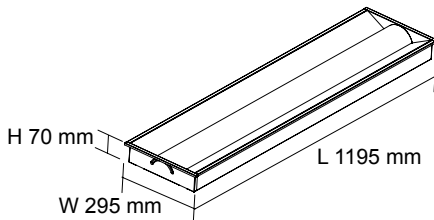

S9725/606

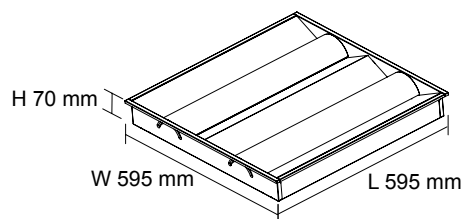

Model No.	Input	Power	Lumen	Beam Angle	CCT	CRI	Fitting Colour
S9725/312CW	240V	38W	3300lm	120°	4000K	>80	Matt White
S9725/606CW	240V	38W	3400lm	120°	4000K	>80	Matt White



LED TRACK LIGHTS



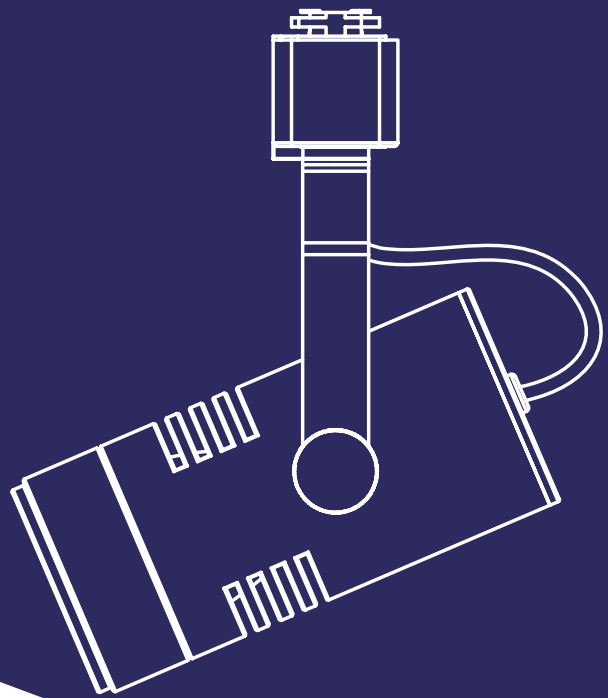

STR4800/1, STR4800/2 UNIVERSAL	125
STR4855L, STR4856L SPOT I	127
STR4863LV WH SPOT III	128
STR4863GU SPOT II	129
STR4861 SPOTTY I	130
STR4866 SPOCK	131
STR4890 UNIVERSAL	133
STR4881 UNIVERSAL I	135
STR4882 UNIVERSAL II	136
STR4883 UNIVERSAL III	137
STR4886 SPOCK	139
STR3/4863GU SPOT IV	140

SINGLE CIRCUIT TRACKS

STR4800/1, STR4800/2 UNIVERSAL

- Extruded aluminium profile
- Powder coated finish
- Length 1 m or 2 m
- Completed with end cap and live end

IP RATING

- IP20 suitable for indoor use only

DIMENSIONS

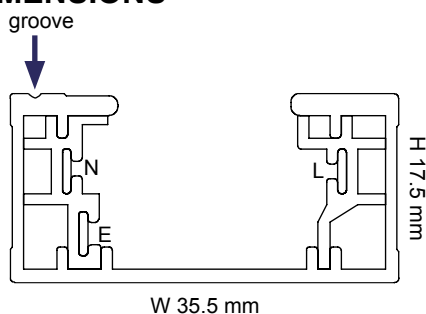

Model No.	Length	Colour
STR4800/1 WH	1m	White
STR4800/1 SL	1m	Silver
STR4800/1 BK	1m	Black

Model No.	Length	Colour
STR4800/2 WH	2m	White
STR4800/2 SL	2m	Silver
STR4800/2 BK	2m	Black

TRACK COMPONENTS

STRAIGHT JOINER

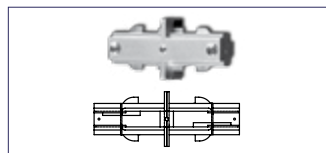

Model No.	Colour
STR4801 WH	White
STR4801 SL	Silver
STR4801 BK	Black

T-SHAPED JOINER

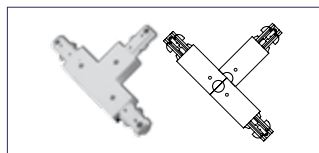

Model No.	Colour
STR4805 WH	White
STR4805 SL	Silver
STR4805 BK	Black

LIVE END

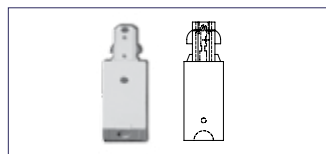

Model No.	Colour
STR4802 WH	White
STR4802 SL	Silver
STR4802 BK	Black

CROSS JOINER

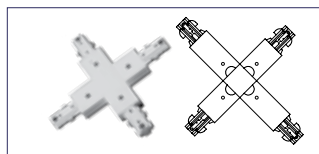

Model No.	Colour
STR4806 WH	White
STR4806 SL	Silver
STR4806 BK	Black

LIVE CENTRE FEED

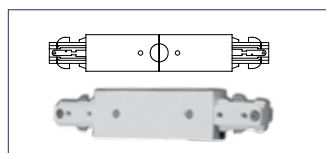

Model No.	Colour
STR4803 WH	White
STR4803 SL	Silver
STR4803 BK	Black

TRACK ADAPTOR

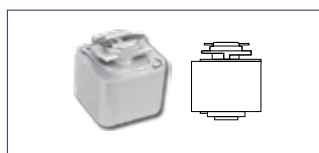

Model No.	Colour
STR4808 WH	White
STR4808 SL	Silver
STR4808 BK	Black

L-SHAPED JOINER

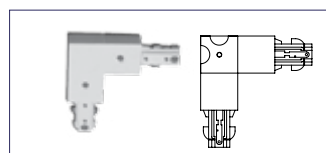

Model No.	Colour
STR4804 WH	White
STR4804 SL	Silver
STR4804 BK	Black



SINGLE CIRCUIT TRACK DIAGRAM

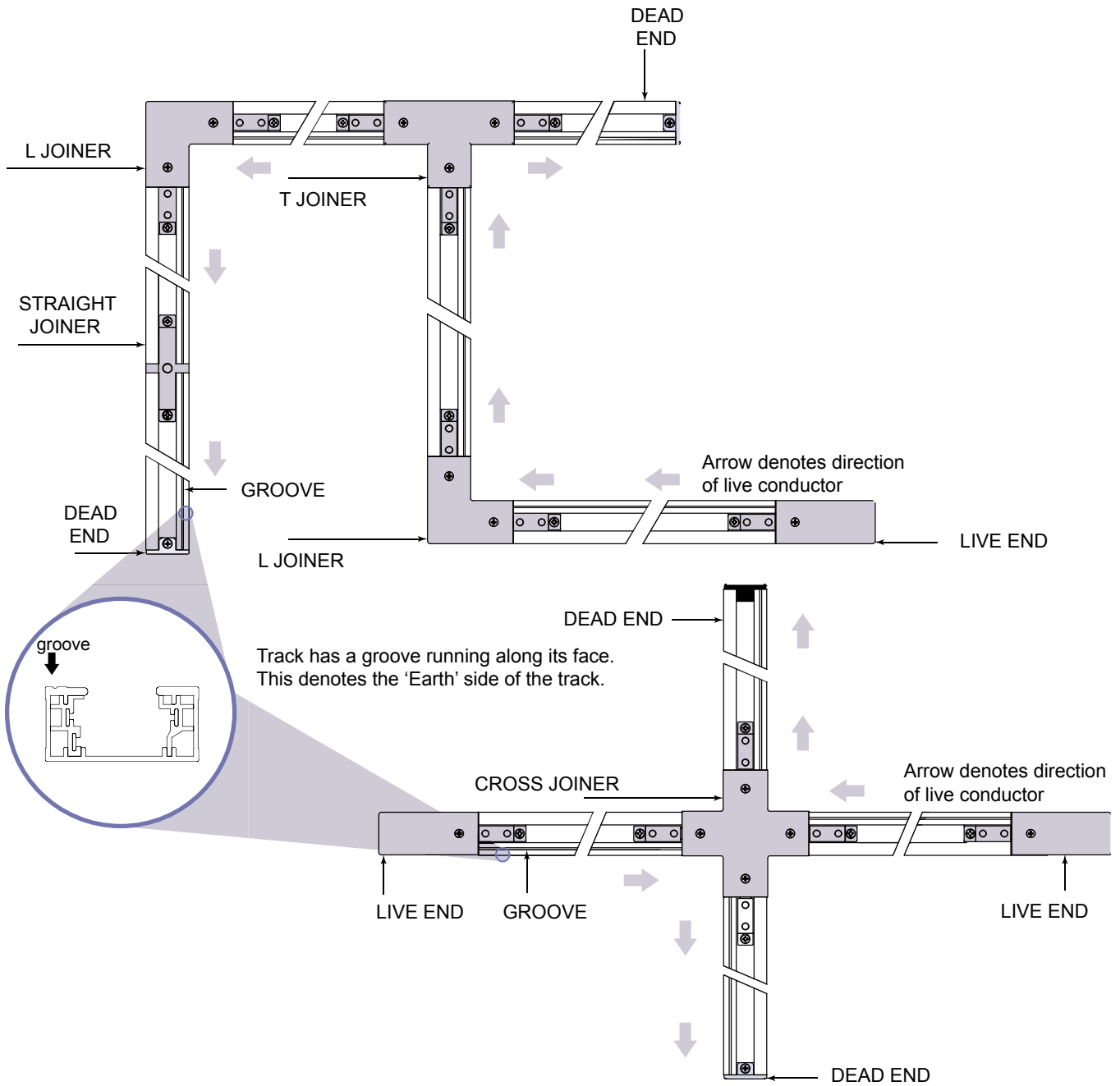

3 WIRE SINGLE CIRCUIT LED TRACK LIGHT

STR4855L, STR4856L SPOT I

CONSTRUCTION

- Die-cast aluminium body
- Powder coated finish
- 12V AC/DC driver fitted
- GU5.3 lamp base
- MR16 5W LED lamp included

IP RATING

- IP20 suitable for indoor use only

LAMP OPTIONS

- MR16/7W
- MR16DIM9W

DIMENSIONS

STR4855L

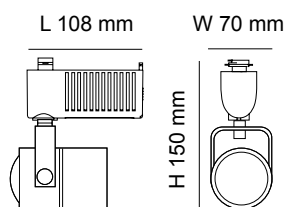

STR4856L

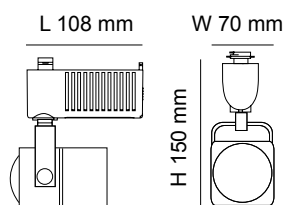

Model No.	Input	Power	Lumen	CCT	CRI	Beam Angle	Fitting Colour
STR4855L WH	240V	5W	350lm	3000K / 6000K	>80	38°	White
STR4855L SL	240V	5W	350lm	3000K / 6000K	>80	38°	Silver
STR4855L BK	240V	5W	350lm	3000K / 6000K	>80	38°	Black

Model No.	Input	Power	Lumen	CCT	CRI	Beam Angle	Fitting Colour
STR4856L WH	240V	5W	350lm	3000K/6000K	>80	38°	White
STR4856L SL	240V	5W	350lm	3000K/6000K	>80	38°	Silver
STR4856L BK	240V	5W	350lm	3000K/6000K	>80	38°	Black

3 WIRE SINGLE CIRCUIT LED TRACK LIGHT

STR4863LV WH SPOT III

CONSTRUCTION

- Die-cast aluminium body
- Powder coated finish
- 12V AC/DC driver fitted
- GU5.3 lamp base
- MR16 5W LED lamp included

IP RATING

- IP20 suitable for indoor use only

LAMP OPTIONS

- MR16/7W
- MR16DIM9W

DIMENSIONS

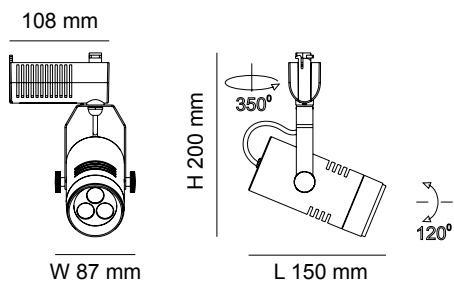

Model No.	Input	Power	Lumen	CCT	CRI	Beam Angle	Fitting Colour
STR4863LV WH	240V	5W	350lm	3000K / 6000K	>80	38°	White

3 WIRE SINGLE CIRCUIT LED TRACK LIGHT

STR4863GU SPOT II

CONSTRUCTION

- Die-cast aluminium body
- Powder coated finish
- GU10 lamp base
- GU10L350 lamp included

IP RATING

- IP20 suitable for indoor use only

LAMP OPTIONS

- GU10L550
- GU10LR750
- GU10LA750

DIMENSIONS

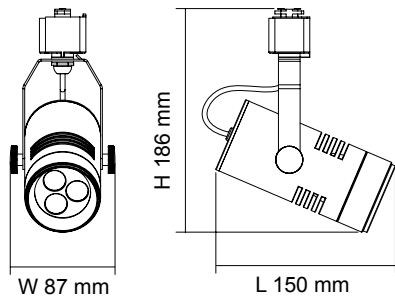

Model No.	Input	Power	Lumen	CCT	CRI	Beam Angle	Fitting Colour
STR4863GU WH	240V	5W	350lm	3000K / 6000K	>80	38°	White
STR4863GU BK	240V	5W	350lm	3000K / 6000K	>80	38°	Black

3 WIRE SINGLE CIRCUIT LED TRACK LIGHT

STR4861 SPOTTY I

CONSTRUCTION

- Die-cast aluminium body
- Powder coated finish
- High efficiency COB LED chip
- Specially designed optical lens
- Standard beam angle 24°
- Built-in LED driver

IP RATING

- IP20 suitable for indoor use only

LENS OPTION

- 36° beam angle lens

DIMENSIONS

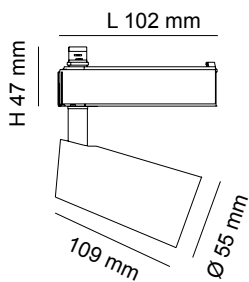

Model No.	Input	Power	Lumen	CCT	CRI	Beam Angle	Fitting Colour
STR4861WW/WH	240V	6W	500lm	3000K	>80	24°	White
STR4861WW/BK	240V	6W	500lm	3000K	>80	24°	Black

PHOTOMETRIC DATA

Unit: cd, B.A. 24°

STR4861WW C0/C180 —
C90/C270 —

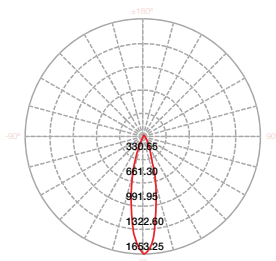

3 WIRE SINGLE CIRCUIT LED TRACK LIGHT

STR4866 SPOCK

CONSTRUCTION

- Premium aluminium body
- Powder coated finish
- Built-in constant current LED driver
- High efficiency COB LED chip
- High performance multi-reflector system
- Standard beam angle 25°

IP RATING

- IP20 suitable for indoor use only

REFLECTOR OPTIONS

- 45° beam angle reflector

DIMENSIONS

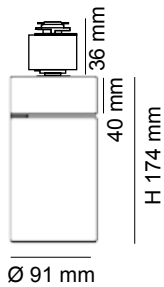

Model No.	Input	Power	Lumen	CCT	CRI	Beam Angle	Fitting Colour
STR4866CW/WH	240V	15W	1600lm	4000K	>80	25°	White
STR4866CW/BK	240V	15W	1600lm	4000K	>80	25°	Black

PHOTOMETRIC DATA

Unit: cd, B.A. 24°

STR4866 C0/C180 —
 C90/C270 —

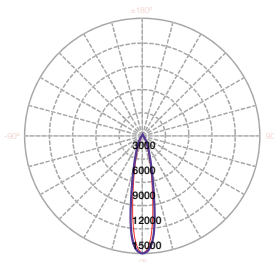



THREE CIRCUIT TRACKS

STR4890 UNIVERSAL

- Extruded aluminium profile
- Powder coated finish
- Length 1 m or 2 m
- Completed with one end cap and live end

IP RATING

- IP20 suitable for indoor use only

DIMENSIONS

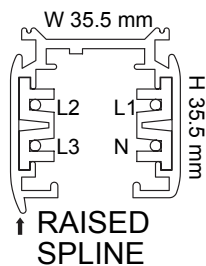

Model No.	Length	Colour
STR4890/1 WH	1m	White
STR4890/1 BK	1m	Black

Model No.	Length	Colour
STR4890/2 WH	2m	White
STR4890/2 BK	2m	Black

TRACK COMPONENTS

MINI JOINER



Model No.	Colour
STR4891 WH	White
STR4891 BK	Black

LIVE END

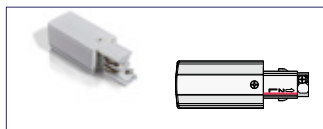

Model No.	Colour
STR4892 WH	White
STR4892 BK	Black

STRAIGHT CONNECTOR

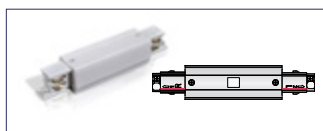

Model No.	Colour
STR4893 WH	White
STR4893 BK	Black

L-SHAPED CONNECTOR



Model No.	Colour
STR4894 WH	White
STR4894 BK	Black

T-SHAPED CONNECTOR



Model No.	Colour
STR4895 WH	White
STR4895 BK	Black

CROSS SHAPED CONNECTOR

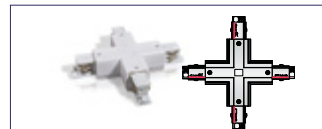

Model No.	Colour
STR4896 WH	White
STR4896 BK	Black

ADJUSTABLE CONNECTOR

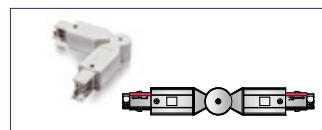

Model No.	Colour
STR4897 WH	White
STR4897 BK	Black

3 CIRCUITS ADAPTOR



Model No.	Colour
STR4898 WH	White
STR4898 BK	Black

T-BAR MOUNTING KIT



Model No.	Colour
STR4899/1 WH	White
STR4899/1 BK	Black

SUSPENSION UNIT FOR ROD (M6 X 1.0 THREADED)



Model No.	Colour
STR4899/2 WH	White
STR4899/2 BK	Black

SUSPENSION UNIT WITH WIRE



Model No.	Colour
STR4899/3 WH	White
STR4899/3 BK	Black

THREE CIRCUIT TRACK DIAGRAM

Track has a raised spline running along one side and track components all have an arrow on one side. To assemble, insert each component into the track so that the arrow is on the same side as the raised spline.

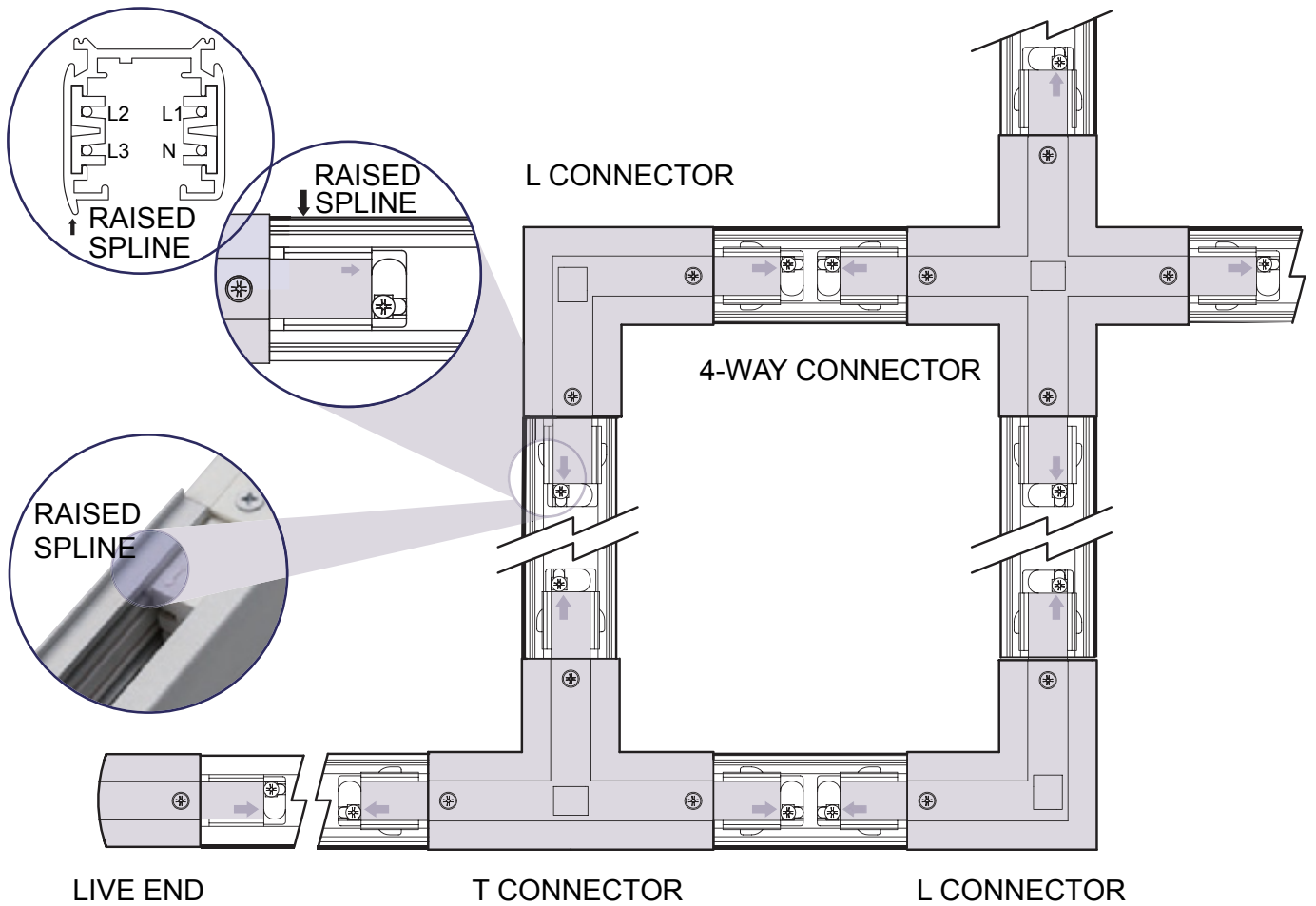

4 WIRE THREE CIRCUIT LED TRACK LIGHT

STR4881 UNIVERSAL I

CONSTRUCTION

- Die-cast aluminium body
- Powder coated finish
- Tempered clear glass cover
- Built-in high efficiency COB LED chip
- Standard beam angle 24°
- Polished aluminium multi-reflector system
- Constant current LED driver fitted

IP RATING

- IP20 suitable for indoor use only

OPTIONS

- Beam angle available in 14°, 18°, 36°



DIMENSIONS

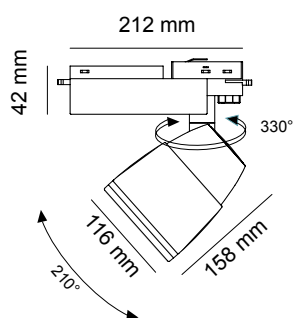

Model No.	Input	Power	Lumen	CCT	GRI	Beam Angle	Fitting Colour
STR4881/30BK WW 24 DG	240V	30W	2600lm	3000K	>80	24°	Black
STR4881/30BK CW 24 DG	240V	30W	2600lm	4000K	>80	24°	Black
STR4881/30WH WW 24 DG	240V	30W	2600lm	3000K	>80	24°	White
STR4881/30WH CW 24 DG	240V	30W	2600lm	4000K	>80	24°	White
STR4881/50BK WW 24 DG	240V	50W	4200lm	3000K	>80	24°	Black
STR4881/50BK CW 24 DG	240V	50W	4200lm	4000K	>80	24°	Black
STR4881/50WH WW 24 DG	240V	50W	4200lm	3000K	>80	24°	White
STR4881/50WH CW 24 DG	240V	50W	4200lm	4000K	>80	24°	White

PHOTOMETRIC DATA

Unit: cd

STR4881/50/WW C0/C180

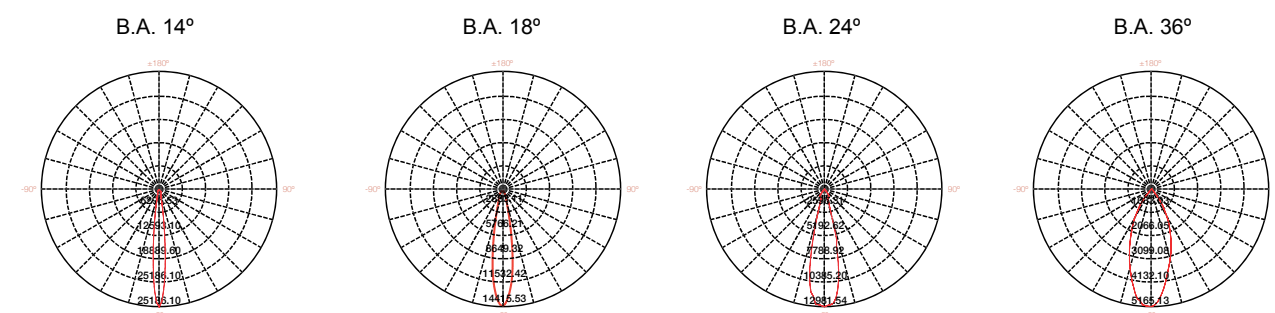

4 WIRE THREE CIRCUIT LED TRACK LIGHT

STR4882 UNIVERSAL II

CONSTRUCTION

- Extruded aluminium body
- Powder coated finish
- Tempered clear glass cover
- Built-in high efficiency COB LED chip
- Polished aluminium multi-reflector system
- Standard beam angle 36°
- Constant current LED driver fitted

IP RATING

- IP20 suitable for indoor use only

OPTIONS

- Beam angle available in 24°

DIMENSIONS

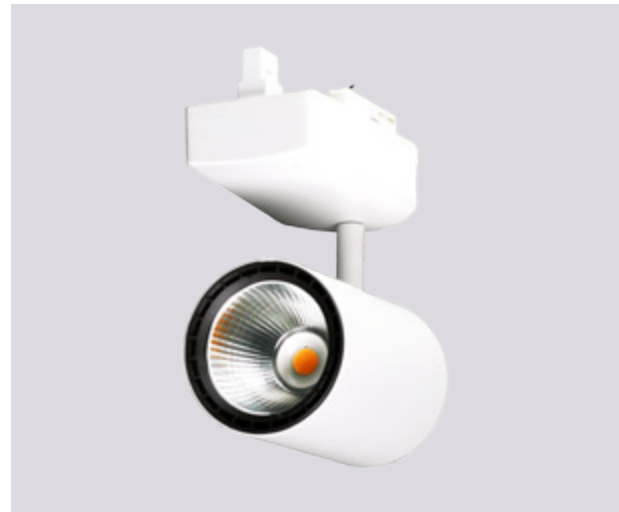
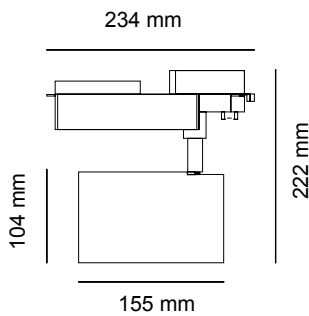

Model No.	Input	Power	Lumen	CCT	CRI	Beam Angle	Fitting Colour
STR4882/36 WH WW	240V	36W	3280lm	3000K	>84	36°	White
STR4882/36 BK WW	240V	36W	3280lm	3000K	>84	36°	Black

PHOTOMETRIC DATA

Unit: cd, C0/C180 ———
C90/C270 ———

B.A. 36° 3000K

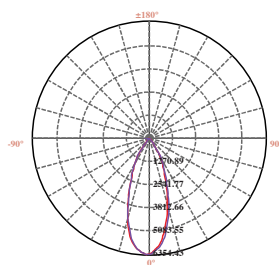

B.A. 36° 4000K

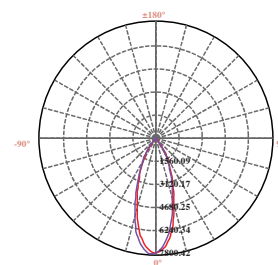

4 WIRE THREE CIRCUIT LED TRACK LIGHT

STR4883 UNIVERSAL III

CONSTRUCTION

- Extruded aluminium body
- Powder coated finish
- Tempered clear glass cover
- Built-in high efficiency COB LED chip
- Polished aluminium multi-reflector system
- Standard beam angle 36°
- Constant current LED driver fitted

IP RATING

- IP20 suitable for indoor use only

OPTIONS

- Beam angle available in 24°



DIMENSIONS

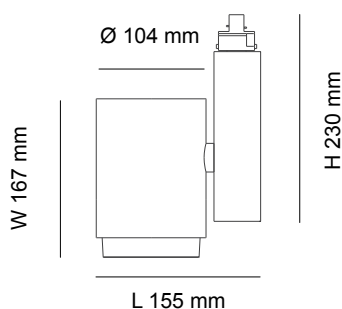

Model No.	Input	Power	Lumen	CCT	CRI	Beam Angle	Fitting Colour
STR4883WW/WH	240V	36W	3280lm	3000K	>80	36°	White
STR4883WW/BK	240V	36W	3280lm	3000K	>80	36°	Black

PHOTOMETRIC DATA

Unit: cd, C0/C180 ————
 C90/C270 ————

B.A. 36° 3000K

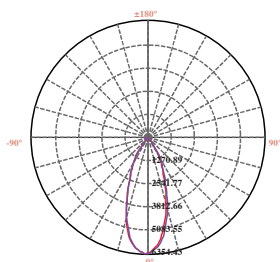

B.A. 36° 4000K

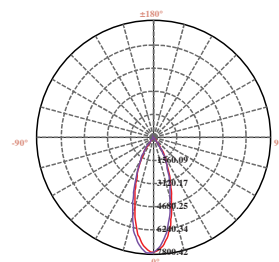



4 WIRE THREE CIRCUIT LED TRACK LIGHT

STR4886 SPOCK

CONSTRUCTION

- Premium aluminium body
- Powder coated finish
- Built-in constant current LED driver
- High efficiency COB LED chip
- High performance multi-reflector system
- Standard beam angle 25°

IP RATING

- IP20 suitable for indoor use only

REFLECTOR OPTIONS

- 45° beam angle reflector

DIMENSIONS

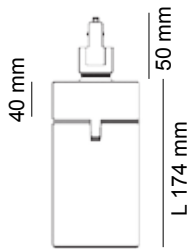

Model No.	Input	Power	Lumen	CCT	CRI	Beam Angle	Fitting Colour
STR4886WW/WH	240V	30W	2600lm	3000K	>80	25°	White
STR4886WW/BK	240V	30W	2600lm	3000K	>80	25°	Black

PHOTOMETRIC DATA

Unit: cd

STR4866 C0/C180 ———
C90/C270 ———

B.A. 25°

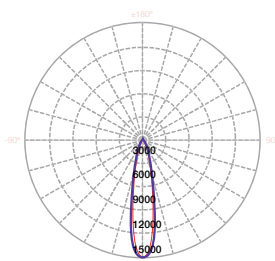

4 WIRE THREE CIRCUIT LED TRACK LIGHT

STR3/4863GU SPOT IV

CONSTRUCTION

- Die-cast aluminium body
- Powder coated finish
- GU10 lamp base
- GU10L350 lamp included

IP RATING

- IP20 suitable for indoor use only

LAMP OPTIONS

- GU10L550
- GU10LR750
- GU10LA750

DIMENSIONS

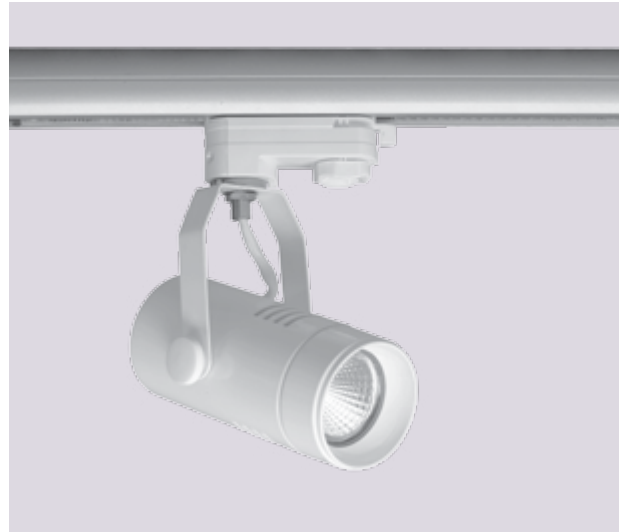
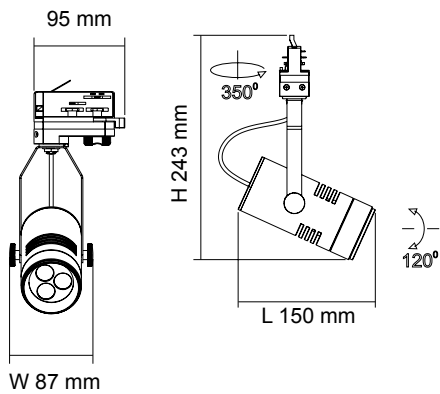

Model No.	Input	Power	Lumen	CCT	CRI	Beam Angle	Fitting Colour
STR3/4863GU WH	240V	5W	350lm	3000K / 6000K	>80	38°	White
STR3/4863GU BK	240V	5W	350lm	3000K / 6000K	>80	38°	Black



LED STRIPS



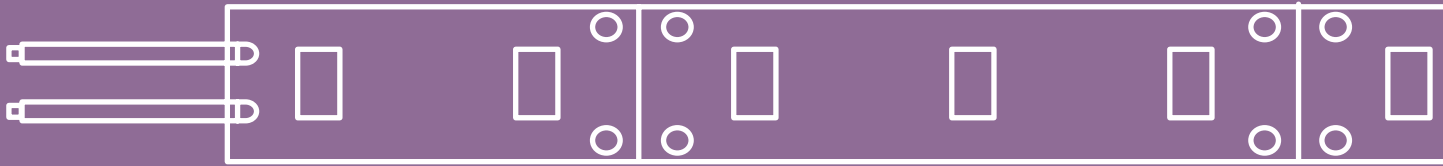

FL1209/S	145
FL1209/SR	145
FL1206 S	146
FL2415RGB/S	147
FLH2420	148
FLP12V2M, FLP12V5M	149
FLP12V5M/RGB	150
SLT1000	151
SLT2000	151
SLT3000	151
SLT4000, SLT4050	152
SLT5000	152
FLC 400 S, FLC 400 RGB	152
LT8903 DIM	153
LT8903 RGB	153
LT8904 DIM/RP	155
LT8904 RGB/RP	155
LT8905 DIM	157
LT8905 RGB	157

LED STRIP RANGE

12V LOW VOLTAGE LED STRIP IP44



FL1209/S

12V LOW VOLTAGE LED STRIP IP67



FL1209/SR

12V LOW VOLTAGE SINGLE COLOUR LED STRIP IP44



FL1206 S



24V LOW VOLTAGE HIGH POWER & CRI LED STRIP IP20



FLH2420

24V LOW VOLTAGE RGB LED STRIP IP44



FL2415RGB/S

12V LED FLEXI STRIP KIT

FLP12V2M, FLP12V5M

12V LED FLEXI RGB STRIP KIT

FLP12V5M/RGB



LED STRIP WITH CONTROLLER WIRING DIAGRAM

SINGLE COLOUR LED STRIP CONNECTION DIAGRAM

TYPE A

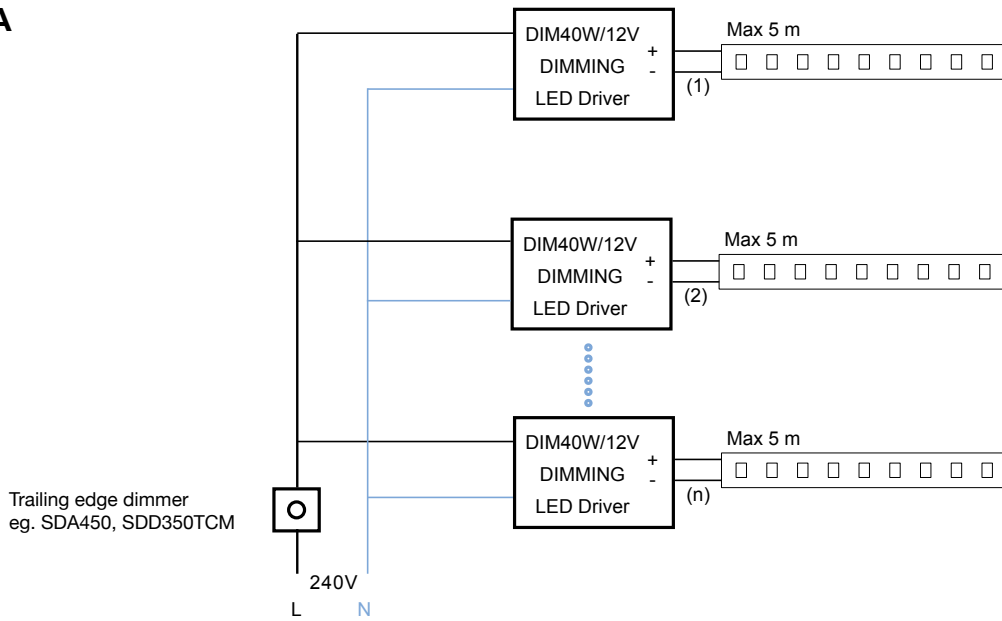

TYPE B

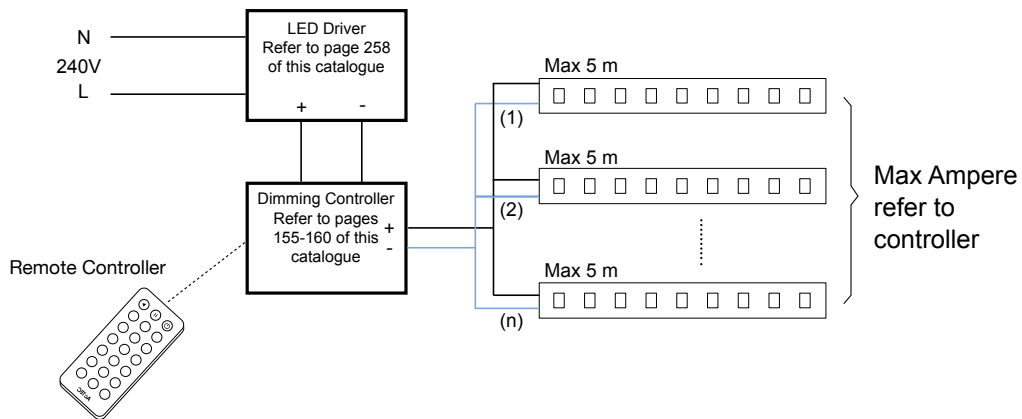

RGB LED STRIP CONNECTION DIAGRAM

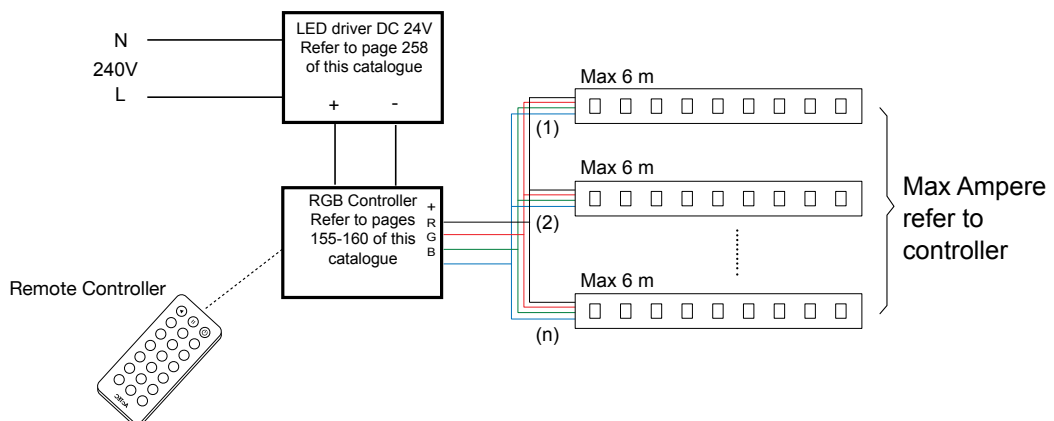

12V LOW VOLTAGE LED STRIP IP44

FL1209/S

12V LOW VOLTAGE LED STRIP IP67

FL1209/SR

CONSTRUCTION

- High efficiency SMD LED chips
- Silicon coated
- Max. roll length 5 m, cuttable every 25 mm at scissors symbol
- Connection length can be extended by certain LED drivers, controllers and repeaters
- Dimmable with compatible controller or dimming LED driver
- Heat sink and 12V LED driver required



SUITABLE LED DRIVER

- PLUTO EGL12V/15W
- PLUTO 30W/12V
- PLUTO 50W/12V
- PLUTO 100W/12V
- PLUTO 200W/12V
- DIM40W/12V

FL1209/SR – SUFFICIENT HEATSINK REQUIRED

DIMMING OPTIONS

TYPE A

- Trailing edge dimmer with DIM40W/12V

TYPE B

- LT8903DIM
- LT8905DIM
- LT8904DIM/RP

FL1209/S – LED CHANNEL REQUIRED

LED Channel options: SLT1000, SLT2000, SLT3000, SLT4000, SLT4050, SLT5000

DIMENSIONS

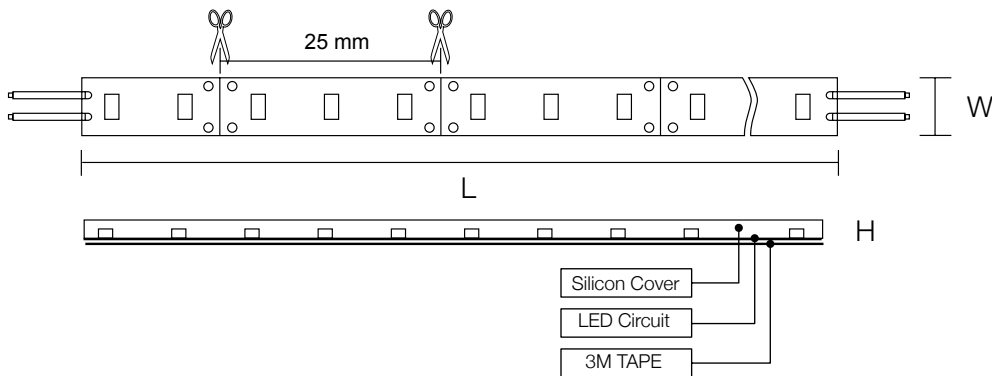

Model No.	Input	Power	Lumen	Beam Angle	Colour Temp	CRI (Ra)	Cuttable Length	Dimensions W x H	IP	LED Quantity
FL1209WW/S	12V/DC	9W/m	500lm/m	115°	3000K	>80	25mm	8 x 2.5 mm	44	120ea/m
FL1209CW/S	12V/DC	9W/m	500lm/m	115°	4000K	>80	25mm	8 x 2.5 mm	44	120ea/m
FL1209DL/S	12V/DC	9W/m	500lm/m	115°	6000K	>80	25mm	8 x 2.5 mm	44	120ea/m
FL1209WW/SR	12V/DC	9W/m	400lm/m	115°	3000K	>80	25mm	10 x 4.5 mm	67	120ea/m
FL1209CW/SR	12V/DC	9W/m	400lm/m	115°	4000K	>80	25mm	10 x 4.5 mm	67	120ea/m
FL1209DL/SR	12V/DC	9W/m	400lm/m	115°	6000K	>80	25mm	10 x 4.5 mm	67	120ea/m



12V LOW VOLTAGE SINGLE COLOUR LED STRIP IP44

FL1206 S

CONSTRUCTION

- High efficiency SMD LED chips
- Silicon coated
- Stable working performance and even light output
- Max. roll length 5 m, cuttable every 50 mm at scissors symbol
- Connection length can be extended by certain LED drivers, controllers and repeaters
- Dimmable with compatible controller
- Heat sink and 12V LED driver required
- LED colours: Red, Green, Blue

SUITABLE LED DRIVER

- PLUTO EGL12V/15W
- PLUTO 30W/12V
- PLUTO 50W/12V
- PLUTO 100W/12V
- PLUTO 200W/12V
- DIM40W/12V

DIMENSIONS

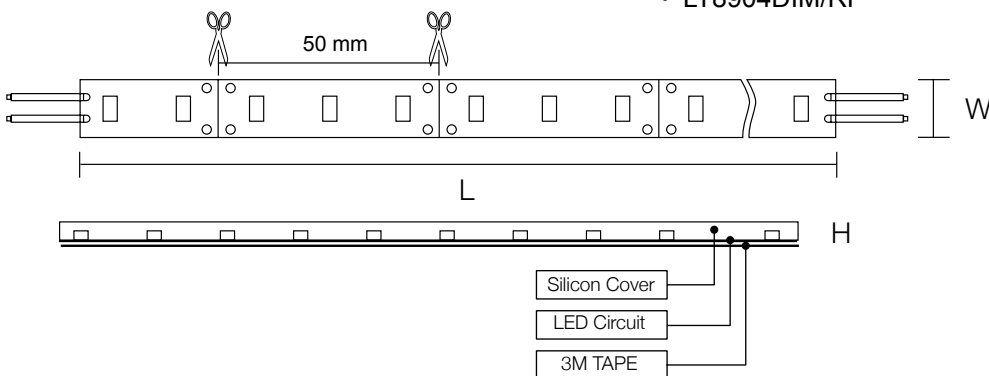

FL1206 S – LED CHANNEL REQUIRED

LED Channel options: SLT1000, SLT2000, SLT3000, SLT4000, SLT4050, SLT5000

DIMMING OPTIONS

TYPE A

- Trailing edge dimmer with DIM40W/12V

TYPE B

- LT8903DIM
- LT8905DIM
- LT8904DIM/RP

Model No.	Input	Power	Lumen	Beam Angle	Colour Temp	CRI (Ra)	Cutttable Length	Dimensions W x H	IP	LED Quantity
FL1206RD/S	12V/DC	6W/m	70lm/m	115°	Red	N/A	50mm	10 x 3.5 mm	44	60ea/m
FL1206GN/S	12V/DC	6W/m	180lm/m	115°	Blue	N/A	50mm	10 x 3.5 mm	44	60ea/m
FL1206BU/S	12V/DC	6W/m	54lm/m	115°	Green	N/A	50mm	10 x 3.5 mm	44	60ea/m

24V LOW VOLTAGE LED RGB STRIP IP44

FL2415RGB/S



CONSTRUCTION

- High efficiency SMD LED chips
- Silicon coated
- Stable working performance and even light output
- Max. roll length 6 m, cuttable every 100 mm at the scissors symbol
- Connection length can be extended by certain LED drivers, controllers and repeaters
- Heat sink and 24V LED driver required
- RGB colour changeable with compatible controller

SUITABLE LED DRIVER

- PLUTO EGL24V/15W
- PLUTO 30W/24V
- PLUTO 50W/24V
- PLUTO 100W/24V
- PLUTO 200W/24V

DIMENSIONS

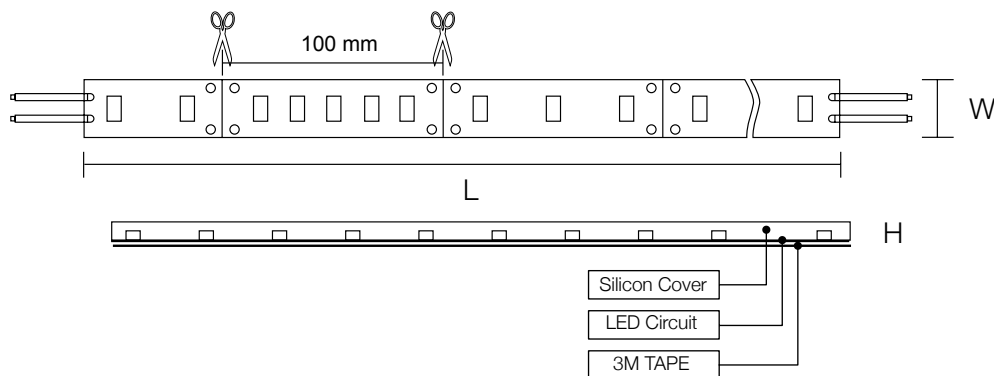

FL2415/RGB/S – LED CHANNEL REQUIRED

LED Channel options: SLT1000, SLT2000, SLT3000, SLT4000, SLT4050, SLT5000

DIMMING OPTIONS - BY CONTROLLERS

- LT8903 RGB
- LT8905 RGB
- LT8904 RGB/RP

Model No.	Input	Power	Lumen	Beam Angle	Colour Temp	CRI (Ra)	Cuttable Length	Dimensions W x H	IP	LED Quantity
FL2415RGB/S	24V/DC	15W/m	100lm/m	115°	RGB	N/A	100 mm	10 x 3.5 mm	44	60ea/m



24V LOW VOLTAGE LED HIGH OUTPUT & CRI STRIP IP20

FLH2420

CONSTRUCTION

- 24V IP20 LED flexible strip with self-adhesive tape on the back
- High efficiency SMD LED chips
- High colour rendering with high output 1500lm/m
- Max. roll length 5 m, cuttable every 62.5 mm at the scissors symbol
- Connection length can be extended by certain LED drivers, controllers and repeaters
- Dimmable with compatible controller
- Heat sink and 24V LED driver required

SUITABLE LED DRIVER

- PLUTO EGL24V/15W
- PLUTO 30W/24V
- PLUTO 50W/24V
- PLUTO 100W/24V
- PLUTO 200W/24V



FLH2420 – LED CHANNEL REQUIRED

LED Channel options: SLT3000, SLT4000

DIMMING OPTIONS BY CONTROLLERS

TYPE B

- LT8903DIM
- LT8905DIM
- LT8904DIM/RP

DIMENSIONS

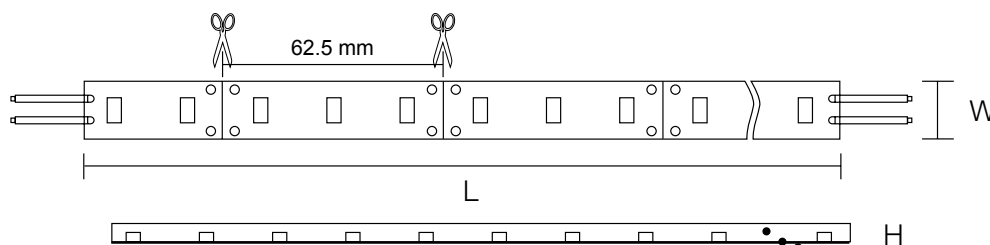

Model No.	Input	Power	Lumen	Beam Angle	Colour Temp	CRI (Ra)	Cuttable Length	Dimensions W x H	IP	LED Quantity
FLH2420 WW	24V/DC	20W/m	1500lm/m	115°	3000K	>82	62.5 mm	8 x 2 mm	20	100ea/m
FLH2420 CW	24V/DC	20W/m	1500lm/m	115°	4000K	>82	62.5 mm	8 x 2 mm	20	100ea/m
FLH2420 DL	24V/DC	20W/m	1500lm/m	115°	6000K	>82	62.5 mm	8 x 2 mm	20	100ea/m



12V SINGLE COLOUR LED FLEXI STRIP KITS

FLP12V2M, FLP12V5M

CONSTRUCTION

- 12V weatherproof LED flexible strip with 3M self-adhesive tapes at back
- Pre-wired strip kit includes LED driver, LED strip & 1.2 m flex & plug
- Plug in & ready to use
- High efficiency SMD LED chips
- Silicon coated
- Stable working performance and even light output
- Cuttable every 50 mm at the scissors symbol
- 2M or 5M package available



IP RATING

- IP44 weatherproof

LED CHANNEL OPTIONS

SLT1000, SLT2000, SLT3000, SLT4000, SLT4050, SLT5000

DIMENSIONS

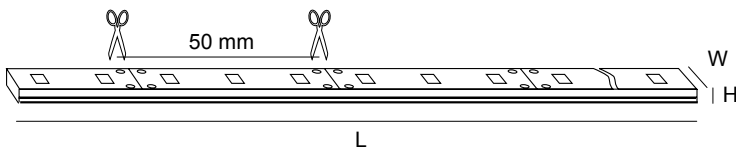

FLP12V5M/WW/S



FLP12V2M/WW/S



FLP12V5M/DL/S



FLP12V2M/DL/S

Model No.	Input	Power	Lumen	Beam Angle	Colour Temp	CRI (Ra)	Cuttable Length	Dimensions L x W x H	LED Quantity
FLP12V2M/WW/S	240V	6W/m	300lm/m	115°	3000K	>80	50 mm	2000 x 10 x 3.5 mm	60ea/m
FLP12V2M/NDL/S	240V	6W/m	300lm/m	115°	5000K	>80	50 mm	2000 x 10 x 3.5 mm	60ea/m
FLP12V5M/WW/S	240V	6W/m	300lm/m	115°	3000K	>80	50 mm	5000 x 10 x 3.5 mm	60ea/m
FLP12V5M/NDL/S	240V	6W/m	300lm/m	115°	5000K	>80	50 mm	5000 x 10 x 3.5 mm	60ea/m



12V RGB LED FLEXI STRIP KIT

FLP12V5M/RGB

CONSTRUCTION

- 12V weatherproof LED flexible strip with 3M self-adhesive tapes at back
- Pre-wired strip kit includes LED driver, LED strip and 1.2 m flex & plug
- Plug in & ready to use
- High efficiency SMD LED chips
- Silicon coated
- Stable working performance and even light output
- Cuttable every 100 mm at the scissors symbol
- Heat sink required
- 5M package available
- Multi-function remote controller included

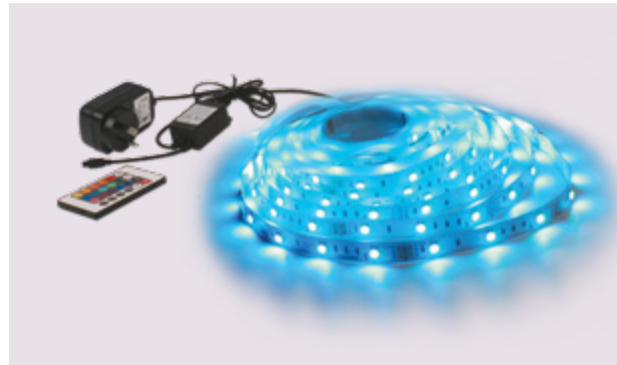

IP RATING

- IP44 weatherproof

LED CHANNEL OPTIONS

SLT1000, SLT2000, SLT3000, SLT4000, SLT4050, SLT5000

DIMENSIONS

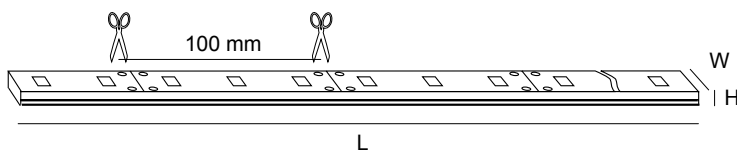

FLP12V5M/RGB

Model No.	Input	Power	Lumen	Beam Angle	Colour Temp	CRI (Ra)	Cuttable Length	Dimensions L x W x H	LED Quantity
FLP12V5M/RGB	240V	5.4W/m	100lm/m	115°	RGB	N/A	100 mm	5000 x 10 x 3.5 mm	30ea/m



LED STRIP CHANNELS

SLT1000

- Extruded aluminium body
- Anodize silver finish
- Clear reeded polycarbonate diffuser
- Come with PVC clips and end cap
- Standard channel length: 1 m or 2 m

DIMENSIONS

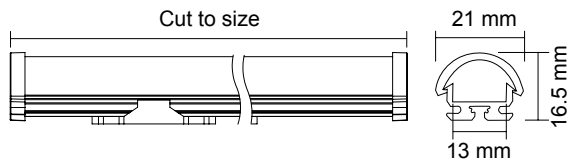

SLT2000

- Extruded aluminium body
- Anodize silver finish
- Clear reeded polycarbonate diffuser
- Come with PVC clips and end cap
- Standard channel length: 1 m or 2 m

DIMENSIONS

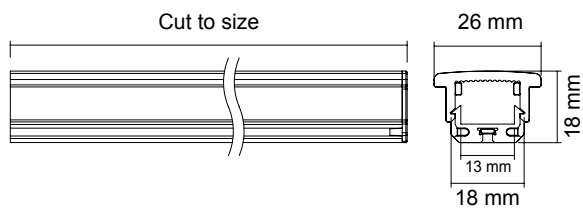

SLT3000

- Extruded aluminium body
- Anodize silver finish
- Opal polycarbonate diffuser
- Comes with end cap
- Standard channel length: 1 m or 2 m

DIMENSIONS

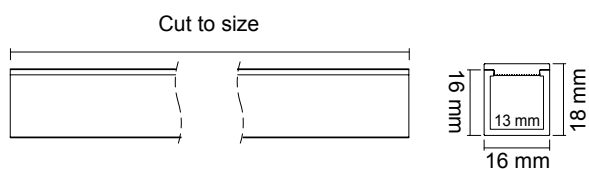

SLT4000, SLT4050

- Extruded aluminium body
- Anodize silver finish
- Opal reeded polycarbonate diffuser
- Comes with end cap
- Standard channel length: 1 m or 2 m

DIMENSIONS

SLT4000

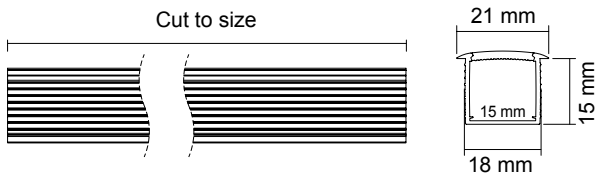

SLT4050

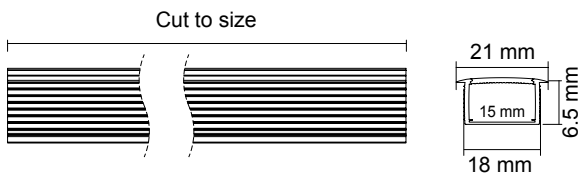

SLT5000

- Extruded aluminium body
- Anodize silver finish
- Opal polycarbonate diffuser
- Come with PVC clips and end cap
- Standard channel length: 1 m or 2 m

DIMENSIONS

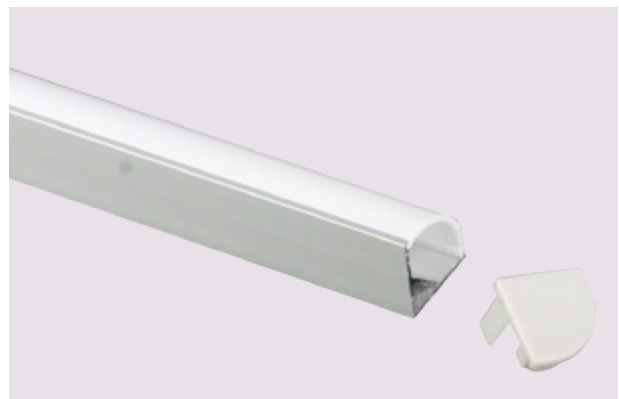
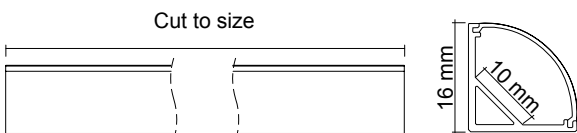

QUICK CONNECT KIT FLC 400 S, FLC 400 RGB

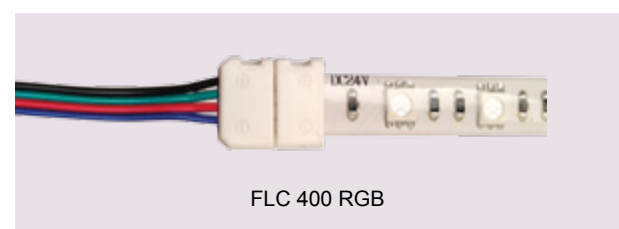
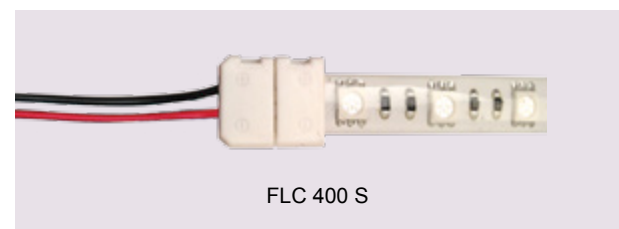
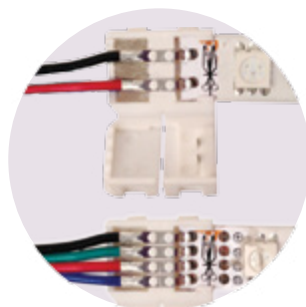

SINGLE COLOUR LED CONTROLLER

LT8903 DIM

- Design for single colour LED brightness control
- Built-in 3 pre-set mode plus adjustable brightness & speed functions
- Adjustable 256 grey scale for fine and smooth change of brightness
- Each controller provides three output channels.
- Each channel has a maximum output current of 3A
- 216 W Max power output at 24V
- Equipped with IR remote controller

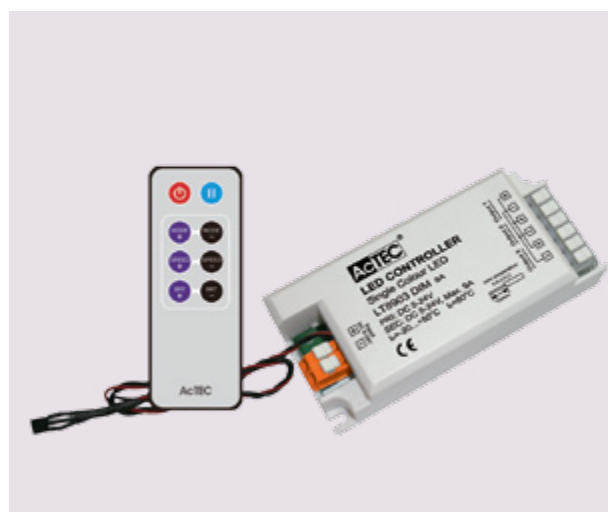

Model No.	Input / Output Voltage	Max Output Current	Max Output Power at 24V	Work Temperature	Dimensions L x W x H	Fixing Centre
LT8903 DIM	5 - 24V	3A x 3 channels	72W x 3 channels	-20° ~ +50°C	105 x 46 x 28 mm	97 mm

RGB LED CONTROLLER

LT8903 RGB

- Design for RGB LED colour brightness control
- Built-in 18 pre-set mode plus adjustable brightness & speed functions
- Adjustable 256 grey scale for fine and smooth change of brightness
- Static brightness and colour control: 16 steps for each RGB channel, i.e. 4096 different colours
- Three RGB independent control channels to create full colour control
- Each channel has a Max output current of 3A
- 216W Max power output at 24V
- Equipped with IR remote controller



Model No.	Input / Output Voltage	Max Output Current	Max Output Power at 24V	Work Temperature	Dimensions L x W x H
LT8903 RGB	6 - 24V	3A x 3 channels	72W x 3 channels	-20° ~ +50°C	105 x 46 x 28 mm

LT8903 DIM MODE FUNCTIONS

No.	Style	Remarks
1	Static	Brightness adjustable
2	Single colour strobe	Brightness and speed adjustable
3	Single colour smooth	Brightness and speed adjustable

DIMENSIONS

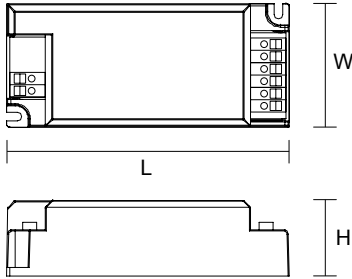

LT8903 RGB MODE FUNCTIONS

No.	Style	Remarks
1	Static red	Brightness adjustable
2	Static green	Brightness adjustable
3	Static blue	Brightness adjustable
4	Static yellow	Brightness adjustable
5	Static purple	Brightness adjustable
6	Static cyan	Brightness adjustable
7	Static white	Brightness adjustable
8	3-colour skipping (RGB)	Brightness & speed adjustable
9	7-colour skipping	Brightness & speed adjustable
10	White colour strobe	Brightness & speed adjustable
11	3-colour smooth (RGB)	Brightness & speed adjustable
12	Full colour smooth	Brightness & speed adjustable
13	RG colour smooth	Brightness & speed adjustable
14	RB colour smooth	Brightness & speed adjustable
15	GB colour smooth	Brightness & speed adjustable
16	White colour fade & change	Brightness & speed adjustable
17	Great cycle	MODE 8-16
18	RGB static dimming	16 levels of brightness per RGB

OPTIONS

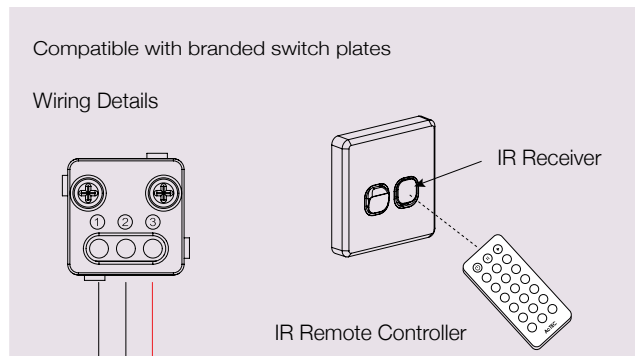
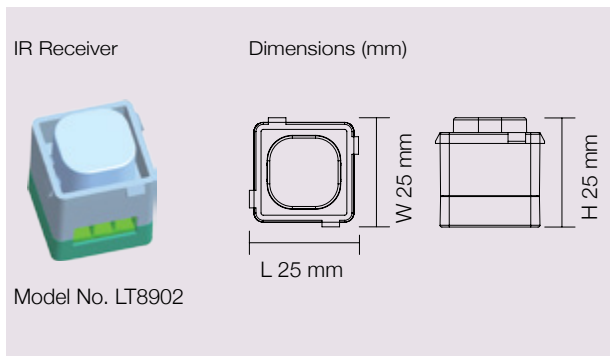

WIRING DIAGRAM

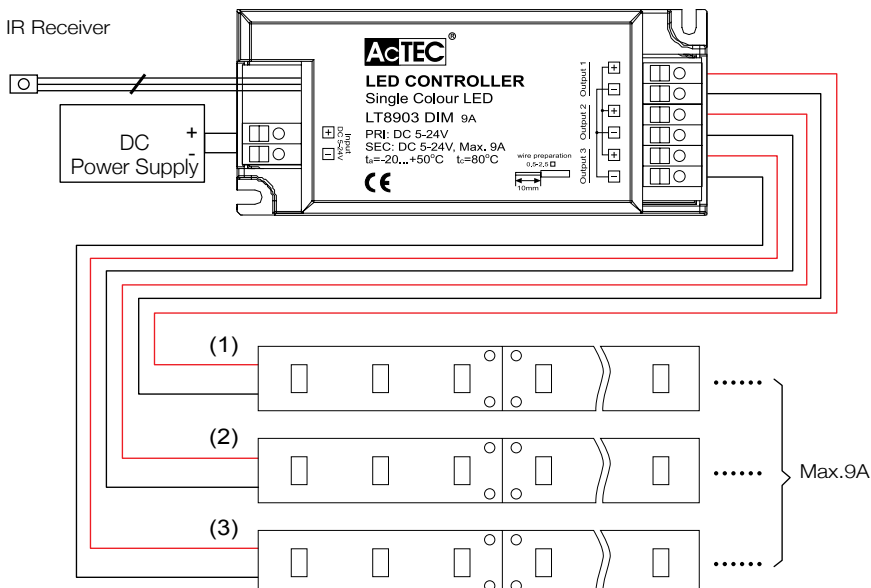

SINGLE COLOUR LED POWER REPEATER

LT8904 DIM/RP

- Design for extending single colour LED strip lights
- With the repeater, one single colour controller controls multiple connections of LED strips
- Each repeater provides two channel output
- Each channel has a Max output current of 4.5A
- 216W Max power output at 24V



Model No.	Input / Output Voltage	Max Output Current	Max Output Power at 24V	Work Temperature	Dimensions L x W x H	Fixing Centre
LT8904 DIM/RP	5 - 24V	4.5A x 2 channels	108W x 2 channels	-20° ~ +50°C	105 x 46 x 28 mm	97 mm

RGB LED POWER REPEATER

LT8904 RGB/RP

- Design for extending RGB LED strip lights
- With repeater, one RGB controller can control multiple connections of LED strips
- Each repeater provides three RGB channels output
- Each channel has a maximum output current of 3A
- 216W Max power output at 24V



Model No.	Input / Output Voltage	Max Output Current	Max Output Power at 24V	Work Temperature	Dimensions L x W x H	Fixing Centre
LT8904 RGB/RP	5 - 24V	3A x 3 channels	72W x 3 channels	-20° ~ +50°C	105 x 46 x 28 mm	97 mm

WIRING DIAGRAM

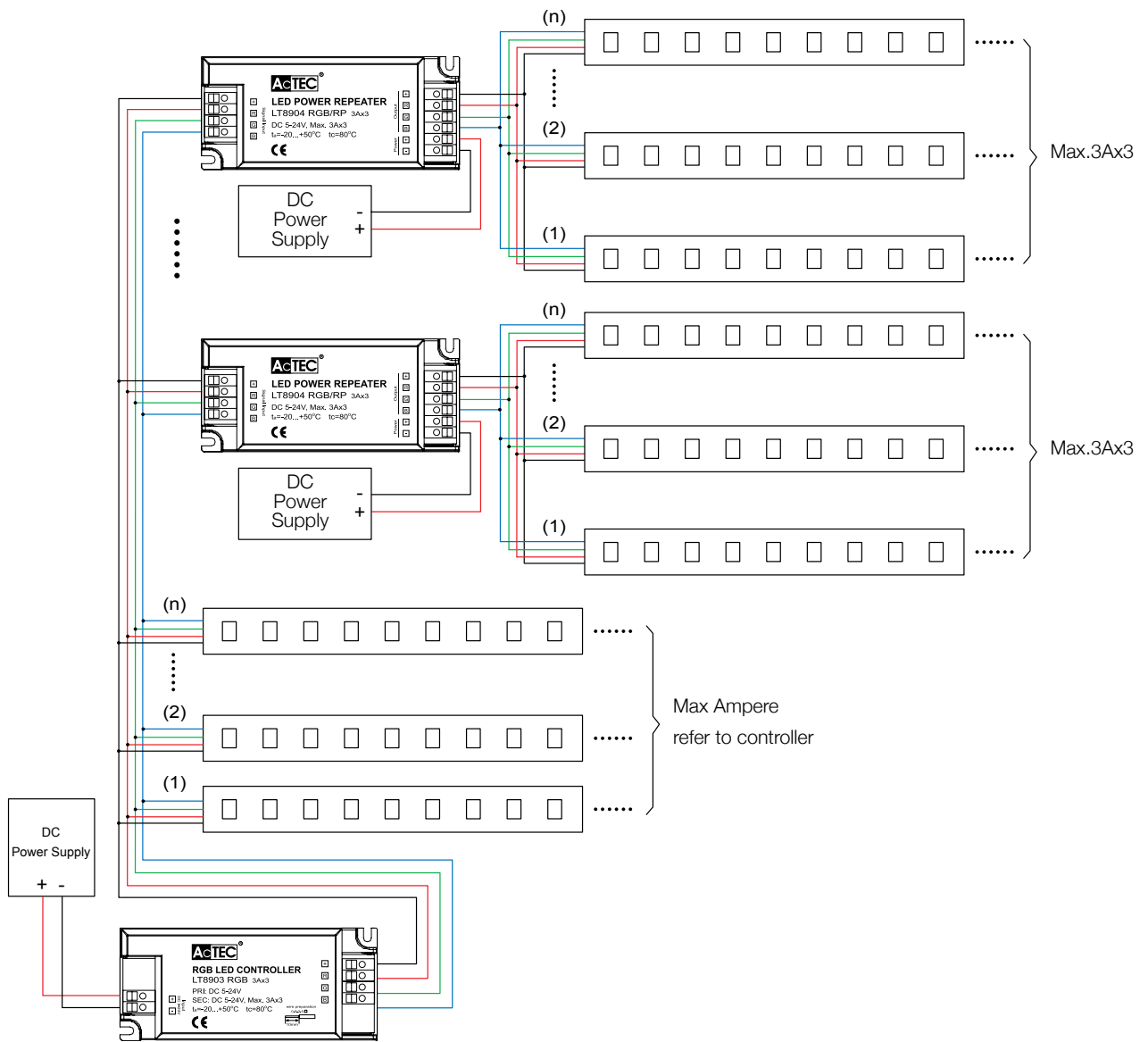

DIMENSIONS

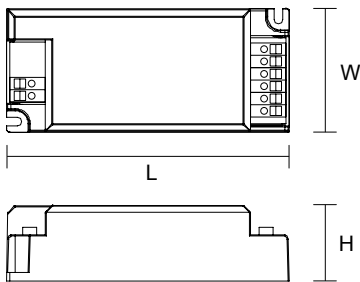

SINGLE COLOUR LED CONTROLLER

LT8905 DIM

- Design for single colour LED brightness control
- Built-in 3 pre-set mode plus adjustable brightness & speed functions
- Each controller provides 2 output channels
- Each channel has a Max output current of 9A
- 432W Max power output at 24V
- Equipped with key panel IR remote controller
- Key panel is compatible with branded 6 gang switch plate



Model No.	Input / Output Voltage	Max Output Current	Max Output Power at 24V	Work Temperature	Dimensions Controller L x W x H	Dimensions Key Board L x W x H
LT8905 DIM	5 - 24V	9A x 2 channels	216W x 2 channels	-20° ~ +50°C	145 x 80 x 30 mm	72 x 46 x 38 mm

RGB LED CONTROLLER

LT8905 RGB

- Design for RGB LED colour brightness control
- Built-in 18 pre-set mode plus adjustable brightness & speed functions
- Adjustable 256 grey scale for fine and smooth change of colours
- Static control of colour and brightness: 16 steps for each RGB channel, i.e. 4096 different colours
- Three RGB independent control channels to create full colour control.
- Each channel has a maximum output current of 6A
- 432W Max power output at 24V
- Equipped with key panel IR remote controller



Model No.	Input / Output Voltage	Max Output Current	Max Output Power at 24V	Work Temperature	Dimensions Controller L x W x H	Dimensions Key Board L x W x H
LT8905 RGB	5 - 24V	6A x 3 channels	144W x 3 channels	-20° ~ +50°C	146 x 80 x 30 mm	72 x 46 x 38 mm

LT8905 DIM MODE FUNCTIONS

No.	Style	Remarks
1	Static	Brightness adjustable
2	Single colour strobe	Brightness and speed adjustable
3	Single colour smooth	Brightness and speed adjustable

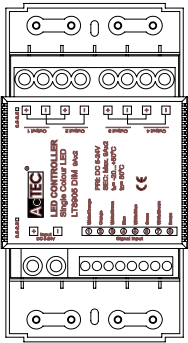

LT8905 DIM/RGB Controller

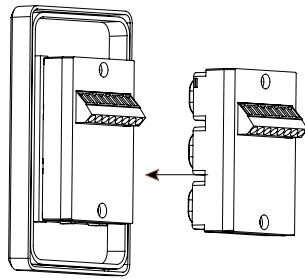

LT8905 DIM/RGB Key Panel Back

LT8905 RGB MODE FUNCTIONS

No.	Style	Remarks
1	Static red	Brightness adjustable
2	Static green	Brightness adjustable
3	Static blue	Brightness adjustable
4	Static yellow	Brightness adjustable
5	Static purple	Brightness adjustable
6	Static cyan	Brightness adjustable
7	Static white	Brightness adjustable
8	3-colour skipping (RGB)	Brightness & speed adjustable
9	7-colour skipping	Brightness & speed adjustable
10	White colour strobe	Brightness & speed adjustable
11	3-colour smooth (RGB)	Brightness & speed adjustable
12	Full colour smooth	Brightness & speed adjustable
13	RG colour smooth	Brightness & speed adjustable
14	RB colour smooth	Brightness & speed adjustable
15	GB colour smooth	Brightness & speed adjustable
16	White colour fade & change	Brightness & speed adjustable
17	Great cycle	MODE 8-16
18	RGB static dimming	16 levels of brightness per RGB

RJ45 Pin Number	CAT.5 Wire Colour
1	White/Orange
2	Orange
3	White/Green
4	Blue
5	White/Blue
6	Green
7	White/Brown
8	Brown

WIRING DIAGRAM

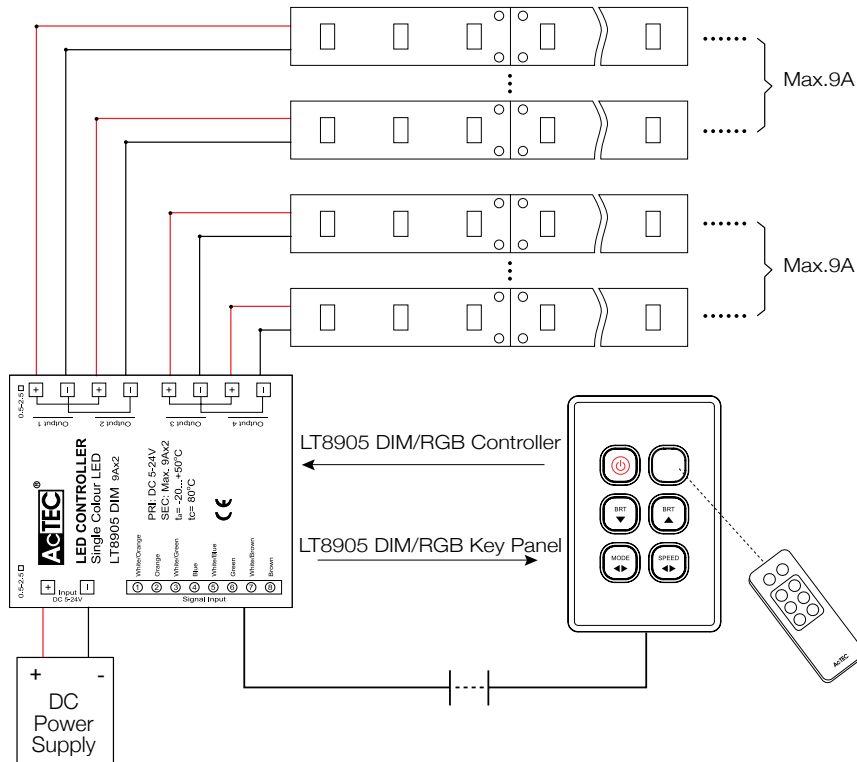



EXTERIOR DOMESTIC LEDS





<u>SE7071 STARPAD</u>	<u>161</u>	<u>SE7133, SE7134 ETON</u>	<u>185</u>
<u>SE7174 NEW STAR</u>	<u>163</u>	<u>SE7121, SE7122, SE7123, SE7128, SE7129, SE7130</u>	
<u>SE7080/1, SE7080/2 STARGEM</u>	<u>165</u>	<u>BONDI</u>	<u>186</u>
<u>SES7080/1, SES7080/2 STARGEM</u>	<u>166</u>	<u>SL7221, SL7222 NEW BONDI</u>	<u>187</u>
<u>SES7090/2 BATWING</u>	<u>167</u>	<u>SE7131, SE7132 NEW FLINDERS WALL</u>	<u>189</u>
<u>SPK1000, SPK2000 STARLIGHT</u>	<u>168</u>	<u>SE7061 NEW FLINDERS POST</u>	<u>190</u>
<u>SPSK1000, SPSK2000 STARLIGHT</u>	<u>169</u>	<u>SE7062 LACHLAN WALL</u>	<u>192</u>
<u>SE7273 LUCIA</u>	<u>170</u>	<u>SE7062 LACHLAN POST</u>	<u>193</u>
<u>SE7013 MOD</u>	<u>170</u>	<u>SE7006, SE7016</u>	
<u>SE7253, SE7254, SE7255 C-SERIES</u>	<u>171</u>	<u>SE7007, SE7017</u>	
<u>SE7250, SE7251, SE7252 M-SERIES</u>	<u>172</u>	<u>SE7008, SE7018</u>	
<u>SL7269, SL7270 BUTTON</u>	<u>173</u>	<u>SE7009, SE7019</u>	
<u>SL7266 MINI SPIKE</u>	<u>174</u>	<u>MURRAY I</u>	<u>195</u>
<u>S9337 BREMER</u>	<u>174</u>	<u>SE7085, SE7086 SWAN</u>	<u>197</u>
<u>SL7261, SL7264 NEWPORT SPIKE</u>	<u>175</u>	<u>SE7051, SE7053 YARRA</u>	<u>198</u>
<u>S9338 GROUND</u>	<u>176</u>		
<u>S9321LV HILLSTONE</u>	<u>177</u>		
<u>S9324 HILLSTONE</u>	<u>177</u>		
<u>S9325, S9326 HILLSTONE</u>	<u>178</u>		
<u>SL7262, SL7267 NEWPORT</u>	<u>179</u>		
<u>SL7263, SL7268 NEWPORT</u>	<u>180</u>		
<u>S9329, S9330 NARRABEEN</u>	<u>181</u>		
<u>SE7258, SE7259, SE7260 SQUARE</u>	<u>182</u>		
<u>S9355 CUBIC</u>	<u>183</u>		
<u>SE7031, SE7033 MAXI</u>	<u>184</u>		

LED FLOOD LIGHT

SE7071 STARPAD



CONSTRUCTION

- Die-cast aluminium body
- Powder coated finish
- Tempered glass front cover
- High efficiency SMD LED chips
- Frost polycarbonate diffuser
- High performance aluminium reflector
- Constant current LED driver fitted
- IP67 nickel plated copper cable gland
- 0.6M rubber flex

IP RATING

- IP65 weatherproof

DIMENSIONS

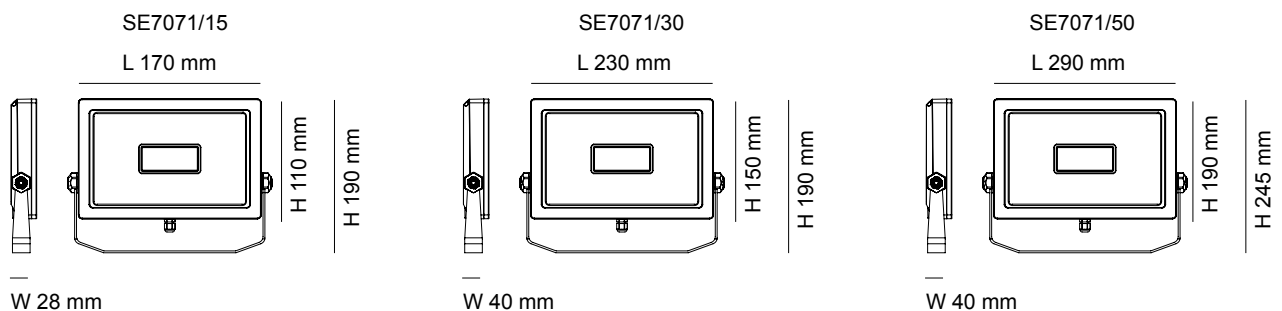

LED FLOOD LIGHT

Model No.	Input	Power	Lumen	CCT	CRI	Beam Angle	Fitting Colour
SE7071/15WW/WH	240V	15W	1100lm	3000K	>80	110°	White
SE7071/15WW/SL	240V	15W	1100lm	3000K	>80	110°	Silver
SE7071/15WW/BK	240V	15W	1100lm	3000K	>80	110°	Black
SE7071/15DL/WH	240V	15W	1200lm	5000K	>80	110°	White
SE7071/15DL/SL	240V	15W	1200lm	5000K	>80	110°	Silver
SE7071/15DL/BK	240V	15W	1200lm	5000K	>80	110°	Black

Model No.	Input	Power	Lumen	CCT	CRI	Beam Angle	Fitting Colour
SE7071/30WW/WH	240V	30W	2300lm	3000K	>80	110°	White
SE7071/30WW/SL	240V	30W	2300lm	3000K	>80	110°	Silver
SE7071/30WW/BK	240V	30W	2300lm	3000K	>80	110°	Black
SE7071/30DL/WH	240V	30W	2500lm	5000K	>80	110°	White
SE7071/30DL/SL	240V	30W	2500lm	5000K	>80	110°	Silver
SE7071/30DL/BK	240V	30W	2500lm	5000K	>80	110°	Black

Model No.	Input	Power	Lumen	CCT	CRI	Beam Angle	Fitting Colour
SE7071/50WW/WH	240V	50W	3700lm	3000K	>80	110°	White
SE7071/50WW/SL	240V	50W	3700lm	3000K	>80	110°	Silver
SE7071/50WW/BK	240V	50W	3700lm	3000K	>80	110°	Black
SE7071/50DL/WH	240V	50W	3900lm	5000K	>80	110°	White
SE7071/50DL/SL	240V	50W	3900lm	5000K	>80	110°	Silver
SE7071/50DL/BK	240V	50W	3900lm	5000K	>80	110°	Black

PHOTOMETRIC DATA

Unit: cd

SE7071/30DL/BK

C0/C180 ———
C90/C270 ———

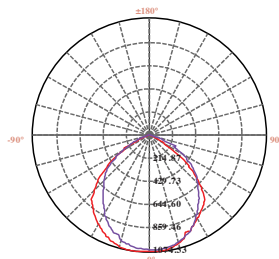

SE7071/50DL/BK

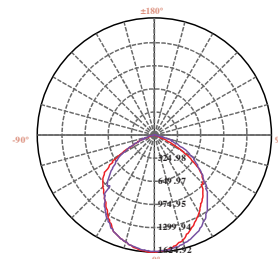

LED FLOOD LIGHT

SE7174 NEW STAR



CONSTRUCTION

- Die-cast aluminium body
- Powder coated finish
- Tempered glass front cover
- High efficiency COB LED chip
- High performance aluminium reflector
- Constant current LED driver fitted
- IP67 nickel plated copper cable gland
- 0.6M rubber flex

IP RATING

- IP65 weatherproof



DIMENSIONS

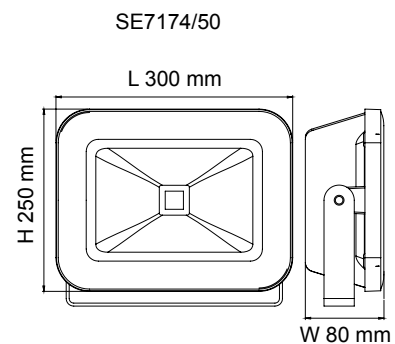
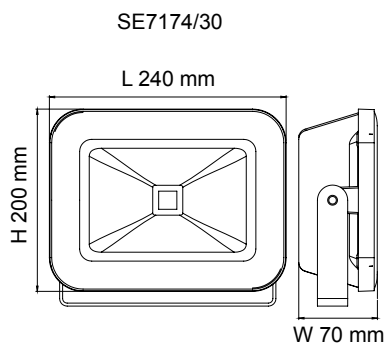
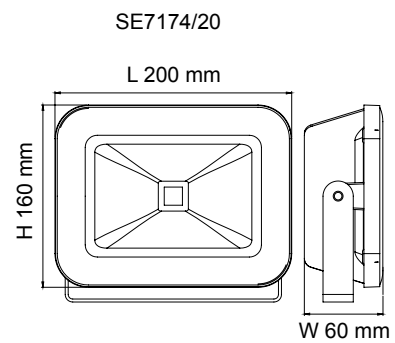
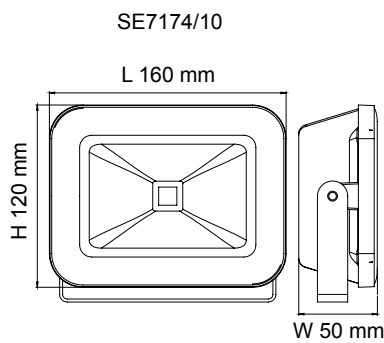

LED FLOOD LIGHT

Model No.	Input	Power	Lumen	CCT	CRI	Beam Angle	Fitting Colour
SE7174/10WW/SL	240V	10W	700lm	3000K	>80	120°	Silver
SE7174/10WW/BK	240V	10W	700lm	3000K	>80	120°	Black
SE7174/10DL/SL	240V	10W	800lm	5700K	>80	120°	Silver
SE7174/10DL/BK	240V	10W	800lm	5700K	>80	120°	Black

Model No.	Input	Power	Lumen	CCT	CRI	Beam Angle	Fitting Colour
SE7174/20WW/SL	240V	20W	1500lm	3000K	>80	120°	Silver
SE7174/20WW/BK	240V	20W	1500lm	3000K	>80	120°	Black
SE7174/20DL/SL	240V	20W	1700lm	5700K	>80	120°	Silver
SE7174/20DL/BK	240V	20W	1700lm	5700K	>80	120°	Black

Model No.	Input	Power	Lumen	CCT	CRI	Beam Angle	Fitting Colour
SE7174/30WW/SL	240V	30W	2300lm	3000K	>80	120°	Silver
SE7174/30WW/BK	240V	30W	2300lm	3000K	>80	120°	Black
SE7174/30DL/SL	240V	30W	2500lm	5700K	>80	120°	Silver
SE7174/30DL/BK	240V	30W	2500lm	5700K	>80	120°	Black

Model No.	Input	Power	Lumen	CCT	CRI	Beam Angle	Fitting Colour
SE7174/50WW/SL	240V	50W	3900lm	3000K	>80	120°	Silver
SE7174/50WW/BK	240V	50W	3900lm	3000K	>80	120°	Black
SE7174/50DL/SL	240V	50W	4200lm	5700K	>80	120°	Silver
SE7174/50DL/BK	240V	50W	4200lm	5700K	>80	120°	Black

LED FLOOD LIGHT

SE7080/1, SE7080/2 STARGEM

CONSTRUCTION

- Adjustable heads with 180° coverage
- Polycarbonate construction base
- Die-cast aluminium heat sink
- Powder coated finish
- Opal polycarbonate diffuser with tempered glass cover
- Built-in high output 2 x 10W LED chips
- High efficiency aluminium reflector
- Constant current LED driver fitted

IP RATING

- IP54 weatherproof



DIMENSIONS

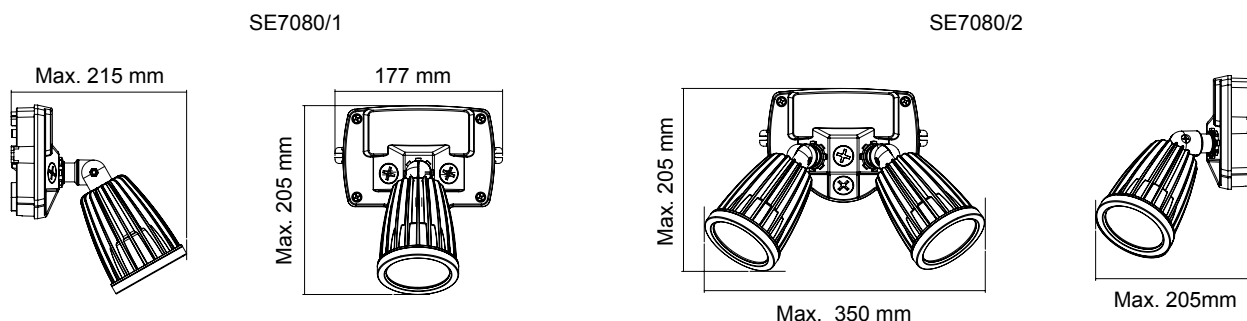

Model No.	Input	Power	Lumen	CCT	CRI	Fitting Colour
SE7080/1 WW BK	240V	10W	600lm	3000K	>80	Black
SE7080/1 DL BK	240V	10W	700lm	6000K	>80	Black

Model No.	Input	Power	Lumen	CCT	CRI	Fitting Colour
SE7080/2 WW SL	240V	2 x 10W	1200lm	3000K	>80	Silver
SE7080/2 WW BK	240V	2 x 10W	1200lm	3000K	>80	Black
SE7080/2 DL SL	240V	2 x 10W	1400lm	6000K	>80	Silver
SE7080/2 DL BK	240V	2 x 10W	1400lm	6000K	>80	Black



LED FLOOD LIGHT

SES7080/1, SES7080/2 STARGEM

CONSTRUCTION

- Adjustable heads with 180° coverage
- Polycarbonate construction base
- Die-cast aluminium heat sink
- Powder coated finish
- Opal polycarbonate diffuser with tempered glass cover
- Built-in high output 2 x 10W LED chips
- High efficiency aluminium reflector
- Constant current LED driver fitted
- Built in infrared motion sensor with override function

IP RATING

- IP54 weatherproof



DIMENSIONS

SES7080/1

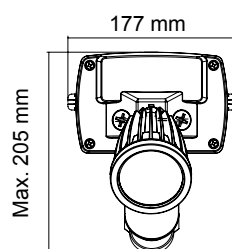
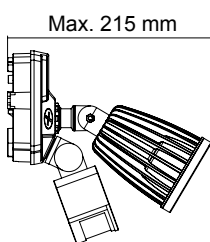

SES7080/2

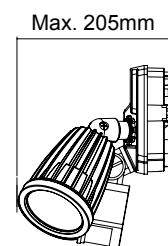
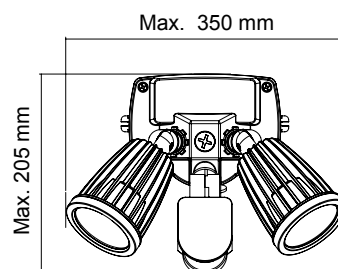

Model No.	Input	Power	Lumen	CCT	CRI	Fitting Colour
SES7080/1 WW BK	240V	10W	600lm	3000K	>80	Black
SES7080/1 DL BK	240V	10W	700lm	6000K	>80	Black

Model No.	Input	Power	Lumen	CCT	CRI	Fitting Colour
SES7080/2 WW BK	240V	2 x 10W	1200lm	3000K	>80	Black
SES7080/2 DL BK	240V	2 x 10W	1400lm	6000K	>80	Black

SENSOR SPECIFICATIONS

Power Source	Detection Distance	Detection Angle	Working Temperature	Working Humidity	Time Setting	Light Control
240V	Max. 11 m	180°	-10°C~+40°C	<93%RH	10sec-4min	<10-2000lux

Power	Detection Motion Speed	Installation Height
0.45W(Static 0.1W)	0.6-1.5 m/s	1.5-3.5 m

LED FLOOD LIGHT

SES7090/2 BATWING

CONSTRUCTION

- Polycarbonate mounting base
- Die-cast aluminium heat sink
- Powder coated finish
- Opal polycarbonate diffuser
- Built-in high output SMD LED chips
- Built-in LED driver on board
- Built in infrared motion sensor with override function

IP RATING

- IP54 weatherproof

DIMENSIONS

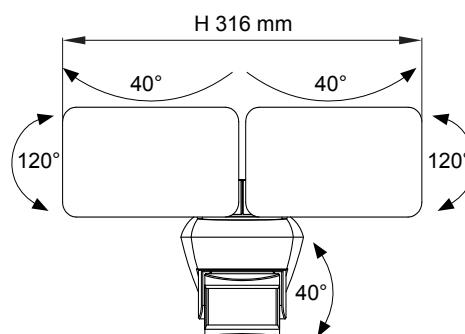
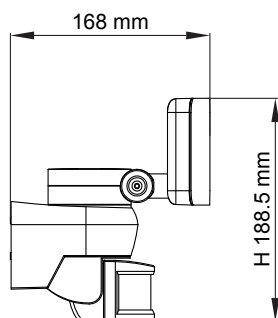

Model No.	Input	Power	Lumen	CCT	CRI	Fitting Colour
SES7090/2WW/BK	240V	2 x 20W	3200lm	3000K	>80	Black
SES7090/2DL/BK	240V	2 x 20W	3500lm	6000K	>75	Black

SENSOR SPECIFICATIONS

Power Source	Detection Distance	Detection Angle	Working Temperature	Working Humidity	Time Setting	Light Control
240V	Max. 10 m	180°	-10°C~+40°C	<93%RH	10sec-12min	<10-2000lux
Power	Detection Motion Speed	Installation Height				
0.45W(Static 0.1W)	0.6-1.5 m/s	1-3 m				

LED FLOOD LIGHT

SPK1000, SPK2000 STARLIGHT

CONSTRUCTION

- Adjustable heads with 180° coverage
- UV stabilized plastic body
- E27 lamp base
- PAR38 LED lamps(s) included

IP RATING

- IP54 weatherproof



DIMENSIONS

SPK1000

SPK2000

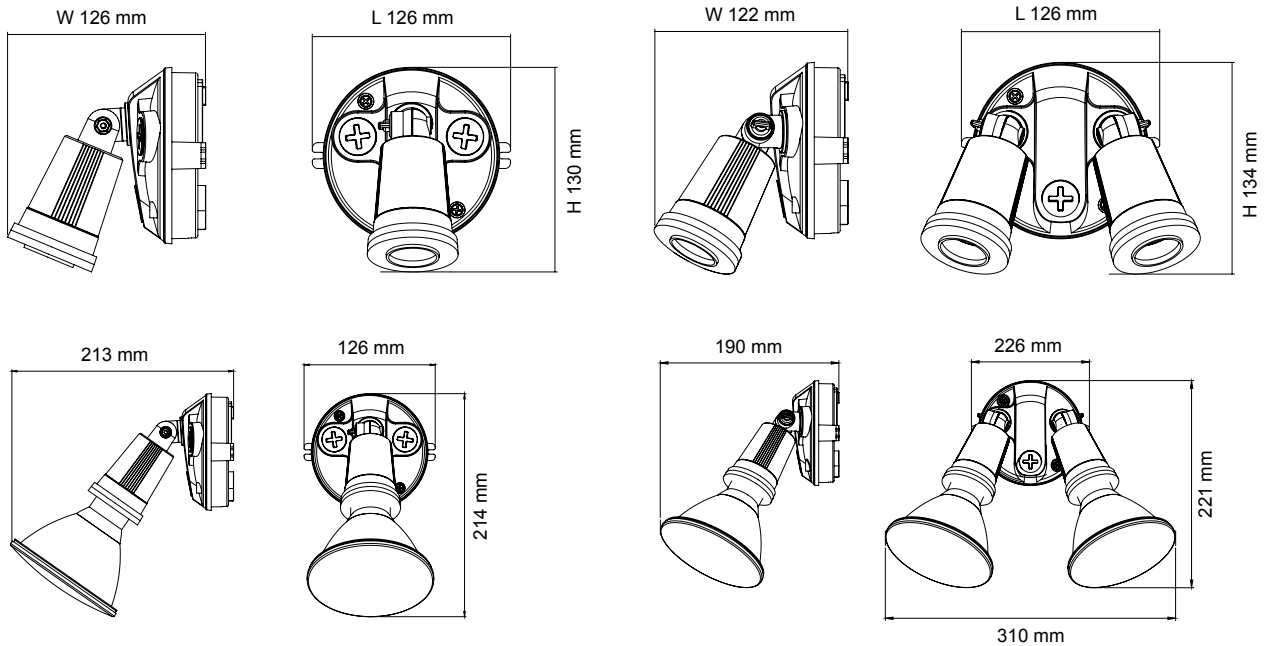

Model No.	Input	Power	Lumen	Beam Angle	CCT	CRI	Fitting Colour
SPK1000 DL BK	240V	12W	1050lm	100°	6000K	>80	Black
SPK2000 DL BK	240V	24W	2100lm	100°	6000K	>80	Black

LED FLOOD LIGHT

SPSK1000, SPSK2000 STARLIGHT



CONSTRUCTION

- Adjustable heads with 180° coverage
- UV stabilized plastic body
- E27 lamp base

- PAR38 LED lamps(s) included
- Built in infrared motion sensor with override function

DIMENSIONS

IP RATING

- IP54 weatherproof

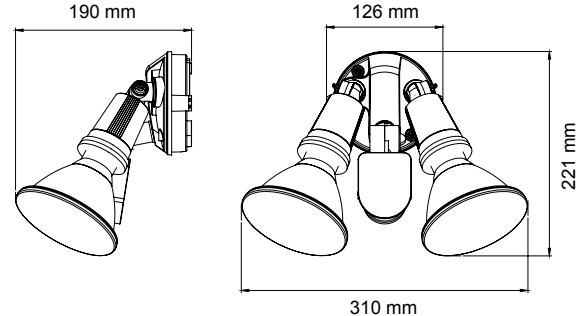
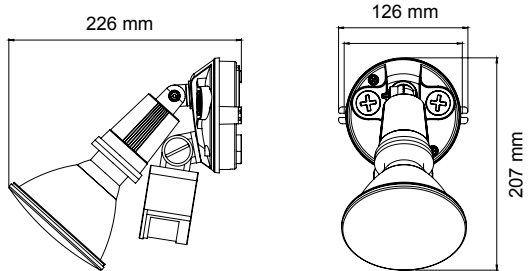
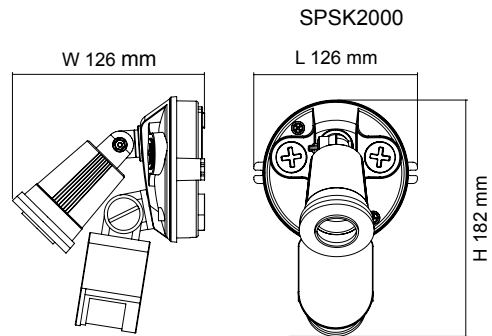
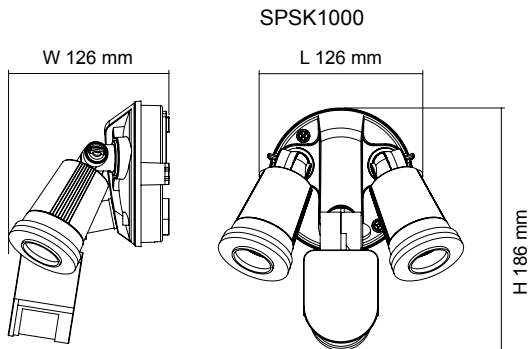

Model No.	Input	Power	Lumen	Beam Angle	CCT	CRI	Fitting Colour
SPSK1000 DL BK	240V	12W	1050lm	100°	6000K	>80	Black
SPSK2000 DL BK	240V	24W	2100lm	100°	6000K	>80	Black

SENSOR SPECIFICATIONS

Power Source	Detection Distance	Detection Angle	Working Temperature	Working Humidity	Time Setting	Light Control
240V	Max. 11 m	180°	-10°C~+40°C	<93%RH	10sec-4min	<10-2000lux

Power	Detection Motion Speed	Installation Height
0.45W(Static 0.1W)	0.6-1.5 m/s	1.5-3.5 m



www.sal.net.au

OYSTER FITTING

SE7273 LUCIA

CONSTRUCTION

- UV stabilized shockproof polycarbonate body
- Opal polycarbonate diffuser
- Double insulation
- E27 lamp base
- Lamp not included

IP RATING

- IP66 weatherproof

LAMP OPTIONS

- LG3 3W, LG5 5W, LG7 7W, LG9 9W
- LGS4, LGS8, LGS10, LGS11D
- LT407, LT409
- LCA35 3W, LFR35 3W

Model No.	Input	Fitting Colour
SE7273 WH	240V	White
SE7273 BK	240V	Black



DIMENSIONS

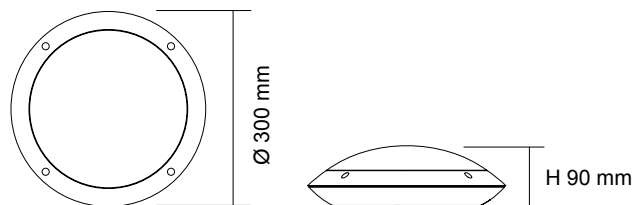

LED WALL LIGHT

SE7013 MOD

CONSTRUCTION

- Stainless steel face panel
- Powder coated finish (Black)
- Opal acrylic diffuser
- E27 lamp base
- Lamp not included

IP RATING

- IP44 weatherproof

LAMP OPTIONS

- LG3 3W, LG5 5W, LG7 7W, LG9 9W
- LGS4, LGS8, LGS10, LGS11D
- LT407, LT409
- LCA35 3W, LFR35 3W

Model No.	Input	Fitting Colour	Lamp Base
SE7013 BK	240V	Black	E27
SE7013 SLS	240V	Stainless Steel	E27

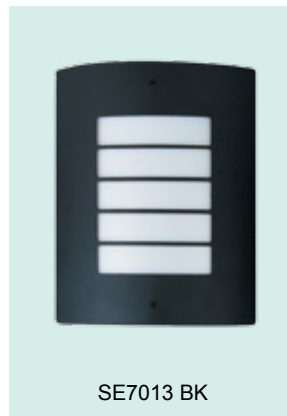

DIMENSIONS

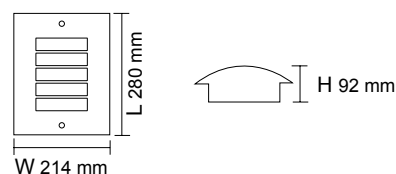

WALL LIGHT FITTING

SE7253, SE7254, SE7255 C-SERIES

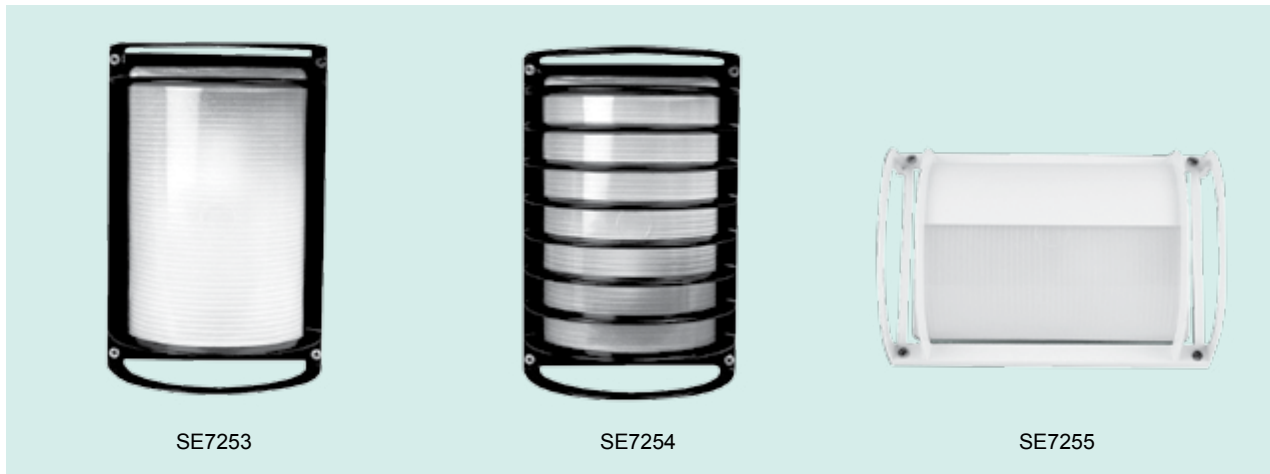

CONSTRUCTION

- Die-cast aluminium body
- Powder coated finish
- Frosted glass diffuser
- E27 lamp base
- Lamp not included

LAMP OPTIONS

- LG3 3W, LG5 5W, LG7 7W, LG9 9W
- LGS4, LGS8, LGS10, LGS11D
- LT407, LT409
- LCA35 3W, LFR35 3W

IP RATING

- IP54 weatherproof

DIMENSIONS

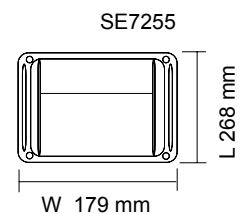
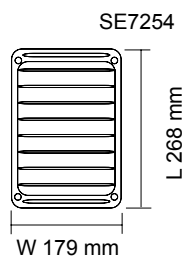
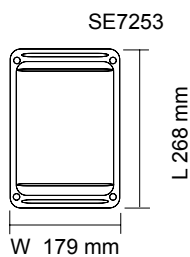

Model No.	Input	Fitting Colour
SE7253 WH	240V	White
SE7253 SL	240V	Silver
SE7253 BK	240V	Black
SE7254 WH	240V	White
SE7254 SL	240V	Silver
SE7254 BK	240V	Black
SE7255 WH	240V	White
SE7255 SL	240V	Silver
SE7255 BK	240V	Black



WALL LIGHT FITTING

SE7250, SE7251, SE7252 M-SERIES



CONSTRUCTION

- Die-cast aluminium body
- Powder coated finish
- Frosted glass diffuser
- E27 lamp base
- Lamp not included

IP RATING

- IP54 weatherproof

LAMP OPTIONS

- LCA35, LFR35
- LT407, LT409

DIMENSIONS

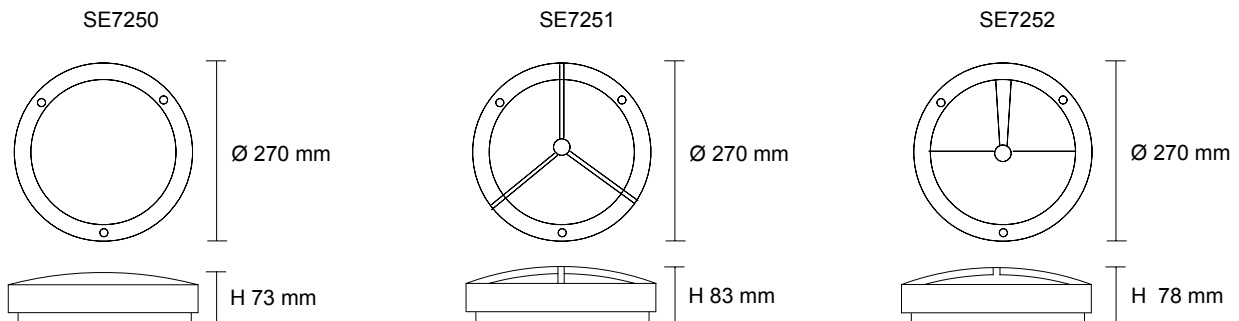

Model No.	Input	Fitting Colour
SE7250 WH	240V	White
SE7250 SL	240V	Silver
SE7250 BK	240V	Black
SE7251 WH	240V	White
SE7251 SL	240V	Silver
SE7251 BK	240V	Black
SE7252 WH	240V	White
SE7252 SL	240V	Silver
SE7252 BK	240V	Black

LED BUNKER LIGHT

SL7269, SL7270 BUTTON

CONSTRUCTION

- Die-cast aluminium body
- Powder coated finish
- Opal polycarbonate diffuser
- High efficiency SMD LED chips
- Built-in LED driver

IP RATING

- IP65 weatherproof

DIMENSIONS

SL7269

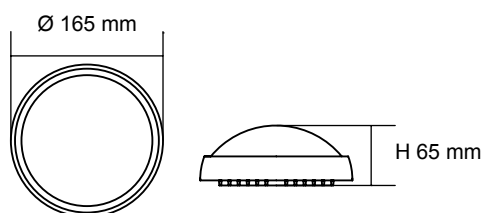

SL7270

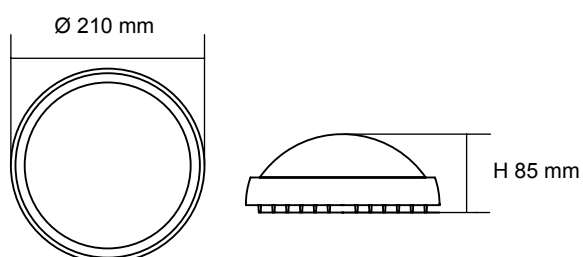

SL7269



SL7270

Model No.	Input	Power	Lumen	CCT	CRI	Fitting Colour
SL7269DL WH	240V	6W	450lm	5000K	>80	White
SL7269DL BK	240V	6W	450lm	5000K	>80	Black

Model No.	Input	Power	Lumen	CCT	CRI	Fitting Colour
SL7270DL WH	240V	12W	800lm	5000K	>80	White
SL7270DL BK	240V	12W	800lm	5000K	>80	Black

LED SPIKE LIGHT

SL7266 MINI SPIKE

CONSTRUCTION

- Die-cast aluminium body
- Powder coated finish
- Built in COB LED chip with aluminium reflector
- 12V AC or DC driver required
- 1.5 m double insulated cable fitted

IP RATING

- IP65 weatherproof

DIMENSIONS

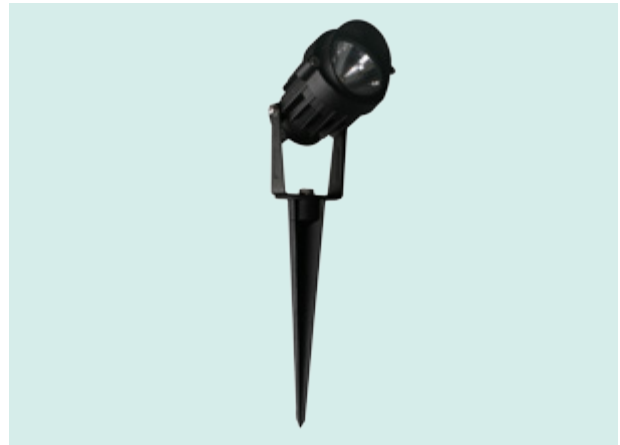
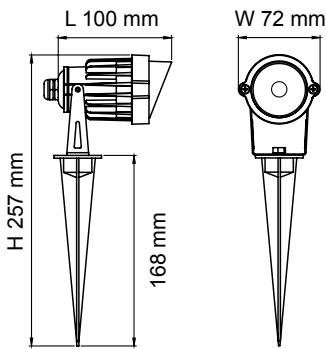

Model No.	Input	Power	Lumen	CCT	CRI	Beam Angle	Fitting Colour
SL7266WW/BK	12V	6W	400lm	2900K	>80	30°	Black

LED WALL LIGHT

S9337 BREMER

CONSTRUCTION

- Die-cast aluminium body
- Stainless steel face panel & screws
- Plastic concrete can included
- High output LED chip
- Built-in constant current LED driver

IP RATING

- IP44 weatherproof

DIMENSIONS

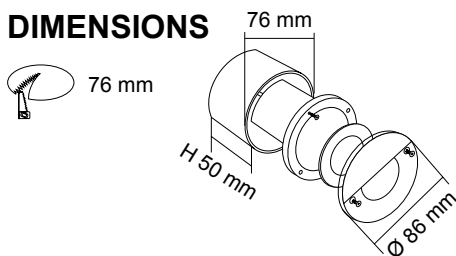

Model No.	Input	Power	Lumen	CCT	CRI	Fitting Colour
S9337	240V	2W	140lm	3000K	>80	Stainless Steel

Specifications above are for reference only and may vary without prior notice

LED SPIKE LIGHT

SL7261, SL7264 NEWPORT SPIKE



CONSTRUCTION

- Machined 316L grade stainless steel body or Aluminium body
- Powder coated finish
- Tempered glass cover
- GU5.3 lamp base
- Lamp (s) not included
- 12V AC or DC driver required

IP RATING

- IP55 weatherproof

LAMP OPTIONS

- MR16 5W
- MR16/7W
- MR16DIM9W

DIMENSIONS

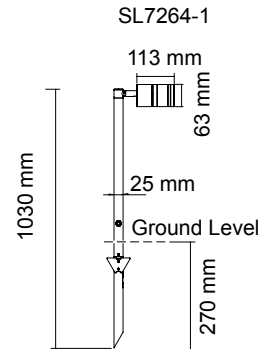
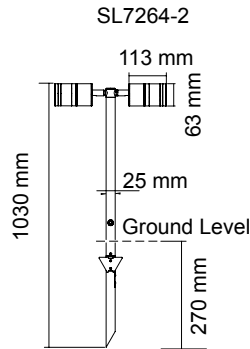
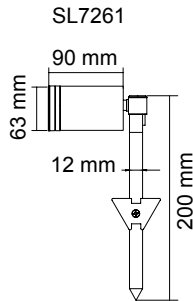

Model No.	Input	Lamp Base	Material	Fitting Colour	Type
SL7261 SLS	12V	GU5.3	Machined 316L grade stainless steel	Stainless steel	Single Head
SL7261 SL	12V	GU5.3	Extruded aluminium	Silver	Single Head
SL7261 BK	12V	GU5.3	Extruded aluminium	Black	Single Head
SL7261 AS	12V	GU5.3	Extruded aluminium	Anodized Silver	Single Head

Model No.	Input	Lamp Base	Material	Fitting Colour	Type
SL7264/40-1 SLS	12V	GU5.3	Machined 316L grade stainless steel	Stainless steel	Single Head
SL7264/40-1 SL	12V	GU5.3	Extruded aluminium	Silver	Single Head
SL7264/40-1 BK	12V	GU5.3	Extruded aluminium	Black	Single Head

Model No.	Input	Lamp Base	Material	Fitting Colour	Type
SL7264/40-2 SLS	12V	GU5.3	Machined 316L grade stainless steel	Stainless steel	Twin Head
SL7264/40-2 SL	12V	GU5.3	Extruded aluminium	Silver	Twin Head
SL7264/40-2 BK	12V	GU5.3	Extruded aluminium	Black	Twin Head



LED INGROUND LIGHT

S9338 GROUND

CONSTRUCTION

- Die-cast aluminium body
- Stainless steel face panel & screws
- Tempered glass diffuser
- Built-in high output 3W LED chip
- 24V AC/DC driver required
- Beam angle 30°
- Lighting direction adjustable from 50°~60°
- PC installation canister included

IP RATING

- IP67 weatherproof

SUITABLE LED DRIVERS

- PLUTO 30W / 24V
- PLUTO 100W / 24V
- PLUTO 200W / 24V

DIMENSIONS

Ø 130 mm



Installation canister Ø 90 mm

Ø 120 mm

H 115 mm



LIGHTING DIRECTION

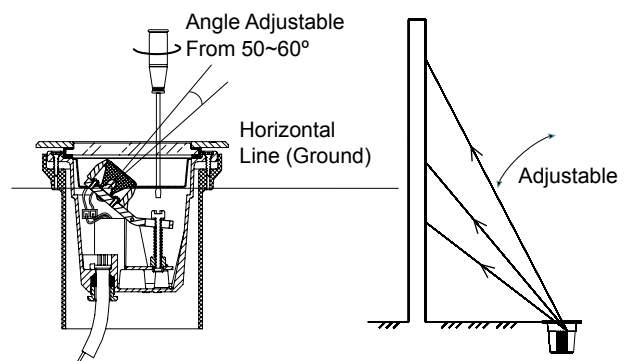

Model No.	Input	Power	Lumen	CCT	CRI	Light Source	Beam Angle	Fitting Colour
S9338/3W/30 WW	24V	3W	150lm	3000K	>70	3W	30°	Stainless Steel
S9338/3W/30 DL	24V	3W	200lm	6000K	>70	3W	30°	Stainless Steel

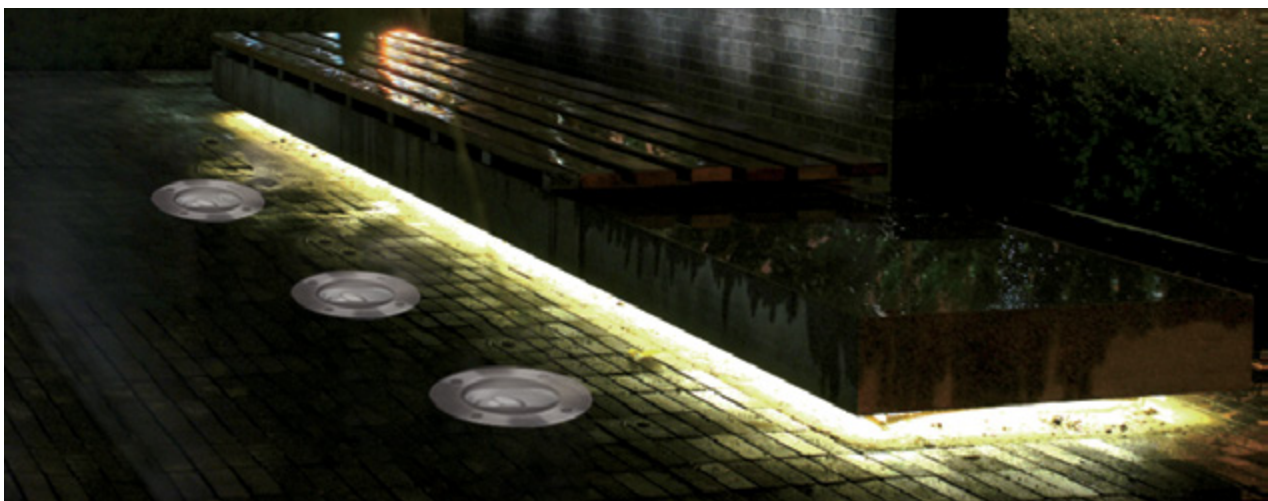

LED WALL LIGHT

S9321LV HILLSTONE

CONSTRUCTION

- Low voltage
- Die-cast aluminium body
- Stainless steel face panel & screws
- Polypropylene installation canister included
- Built in LED chips
- 24V DC driver required

SUITABLE LED DRIVERS

- PLUTO EGL24V/15W
- PLUTO 30W/24V
- PLUTO 100W/24V
- PLUTO 200W/24V



S9321LV BU

IP RATING

- IP65 weatherproof

DIMENSIONS



S9321LV Face Panel

S9321LV Installation canister

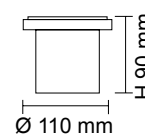

Model No.	Input	Power	Lumen	Beam Angle	Ta	LED Colour
S9321LV BU	24V	2W	24lm	60°	-10~55°C	Blue

LED WALL LIGHT

S9324 HILLSTONE

CONSTRUCTION

- Polycarbonate body
- 304 Stainless steel face panel & screws
- Polypropylene installation canister included
- Built-in LED chips & driver

IP RATING

- IP65 weatherproof

DIMENSIONS

S9324 Face Panel

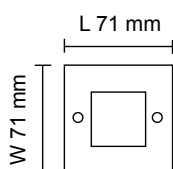

S9324G Face Panel

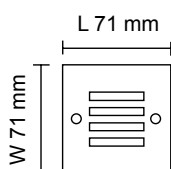

Installation canister

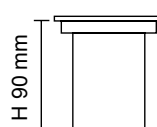

S9324G WH



S9324 BU

Model No.	Input	Power	Lumen	Beam Angle	Ta	LED Colour
S9324 WH	240V	1.5W	30lm	120°	-10~55°C	White
S9324 BU	240V	1.5W	10lm	120°	-10~55°C	Blue
S9324G WH	240V	1.5W	30lm	120°	-10~55°C	White
S9324G BU	240V	1.5W	10lm	120°	-10~55°C	Blue



White



Blue



LED WALL LIGHT

S9325, S9326 HILLSTONE

CONSTRUCTION

- Polycarbonate body
- 304 Stainless steel face panel & screws
- Polypropylene installation canister included
- Built-in LED chips & driver

IP RATING

- IP65 weatherproof

DIMENSIONS

S9325

Face Panel

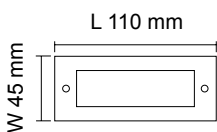

S9326

Face Panel

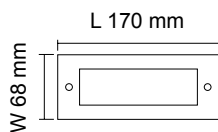

S9325G

Face Panel

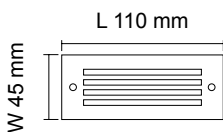

S9326G

Face Panel

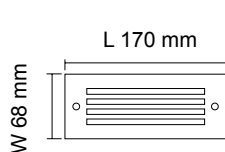

Installation canister

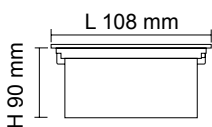

Installation canister

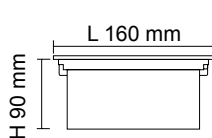

Model No.	Input	Power	Lumen	Beam Angle	Ta	LED Colour
S9325 WH	240V	2.5W	30lm	120°	-10~55°C	White
S9325 BU	240V	2.5W	10lm	120°	-10~55°C	Blue
S9325G WH	240V	2.5W	30lm	120°	-10~55°C	White
S9325G BU	240V	2.5W	10lm	120°	-10~55°C	Blue

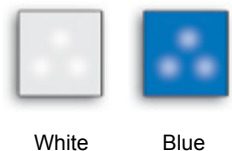

Model No.	Input	Power	Lumen	Beam Angle	Ta	LED Colour
S9326 BU	240V	2.5W	36lm	120°	-10~55°C	Blue
S9326G BU	240V	2.5W	36lm	120°	-10~55°C	Blue

LED WALL LIGHT

SL7262, SL7267 NEWPORT

CONSTRUCTION

- Die-cast aluminium body
- Powder coated finish
- Tempered glass cover
- Installation canister included
- GU5.3 lamp base
- Lamp not included
- 12V AC or DC transformer required

IP RATING

- IP65 weatherproof

DIMENSIONS

SL7262

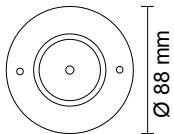

Installation canister

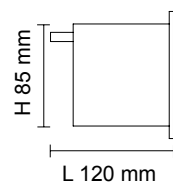

SL7267

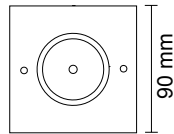

Installation canister

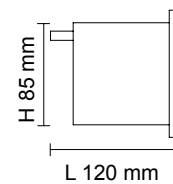

LAMP OPTIONS

- MR16 5W
- MR16/7W
- MR16DIM9W

Model No.	Input	Lamp Base	Fitting Colour
SL7262 BK	12V	GU5.3	Black
SL7262 SL	12V	GU5.3	Silver
SL7262 SA	12V	GU5.3	Stainless Steel Cover
SL7262 SLS	12V	GU5.3	Stainless Steel

Model No.	Input	Lamp Base	Fitting Colour
SL7267 BK	12V	GU5.3	Black
SL7267 SL	12V	GU5.3	Silver
SL7267 SA	12V	GU5.3	Stainless Steel Cover
SL7267 SLS	12V	GU5.3	Stainless Steel



SL7262 SLS

SL7262 BK



SL7267 SLS

SL7267 BK

INSTALLATION CANISTER ATTACHED

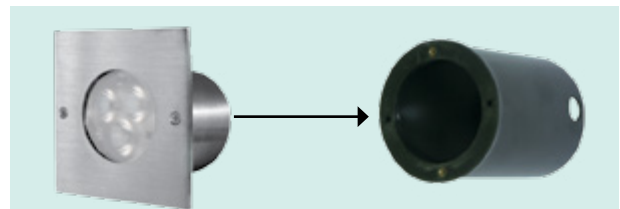

LAMP OPTIONS



MR16 5W

MR16/7W

MR16DIM9W

LED WALL LIGHT

SL7263, SL7268 NEWPORT

CONSTRUCTION

- Die-cast aluminium body
- Powder coated finish
- Tempered glass cover
- Installation canister included
- GU5.3 lamp base
- Lamp not included
- 12V AC or DC transformer required

IP RATING

- IP65 weatherproof

DIMENSIONS

SL7263

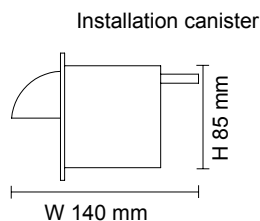
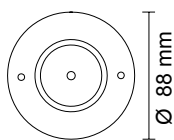

SL7268

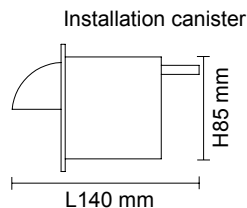
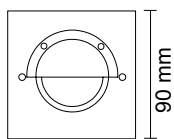

LAMP OPTIONS

- MR16 5W
- MR16/7W
- MR16DIM9W

Model No.	Input	Lamp Base	Fitting Colour
SL7263 BK	12V	GU5.3	Black
SL7263 SL	12V	GU5.3	Silver
SL7263 SA	12V	GU5.3	Stainless Steel Cover
SL7263 SLS	12V	GU5.3	Stainless Steel

Model No.	Input	Lamp Base	Fitting Colour
SL7268 BK	12V	GU5.3	Black
SL7268 SL	12V	GU5.3	Silver
SL7268 SA	12V	GU5.3	Stainless Steel Cover
SL7268 SLS	12V	GU5.3	Stainless Steel



SL7263 SLS

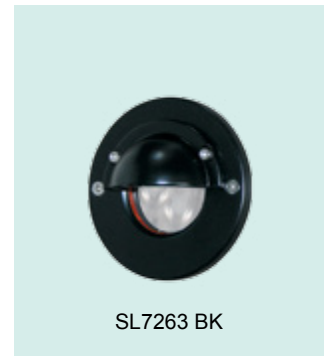

SL7263 BK



SL7268 SLS

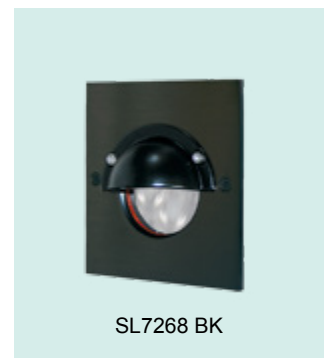

SL7268 BK

INSTALLATION CANISTER ATTACHED

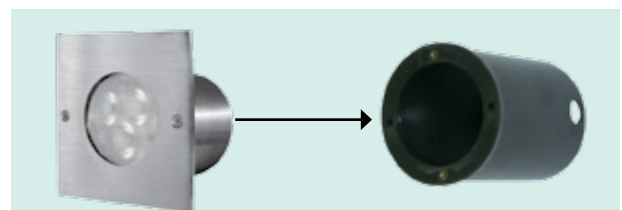

LAMP OPTIONS



MR16 5W



MR16/7W



MR16DIM9W

LED WALL LIGHT

S9329, S9330 NARRABEEN

CONSTRUCTION

- Die-cast aluminium body
- Powder coated finish
- Clear polycarbonate diffuser
- High output LED chips
- 12V AC or DC LED driver required
- 0.5 m rubber flex

SUITABLE LED DRIVERS

- PLUTO EGL12V/6W
- PLUTO EGL12V/15W
- PLUTO 30W/12V
- PLUTO 50W/12V
- PLUTO 100W/12V
- PLUTO 200W/12V

IP RATING

- IP65 weatherproof

DIMENSIONS

S9329

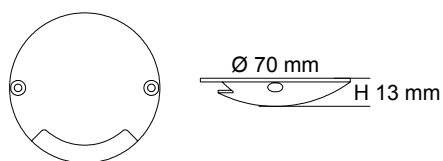

S9330

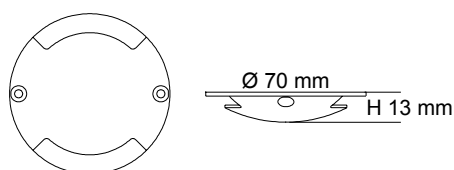

Model No.	Input	Power	Lumen	CCT	CRI	Dimmable	Installation	Fitting Colour
S9329BK	12V	0.5W	20lm	5000K	>80	No	Surface Mounted	Black
S9329SL	12V	0.5W	20lm	5000K	>80	No	Surface Mounted	Silver
S9330BK	12V	1W	40lm	5000K	>80	No	Surface Mounted	Black
S9330SL	12V	1W	40lm	5000K	>80	No	Surface Mounted	Silver

LED WALL LIGHT

SE7258, SE7259, SE7260 SQUARE

CONSTRUCTION

- Die-cast aluminium body
- Powder coated finish
- Tempered glass diffuser
- G4 Bi-Pin lamp base
- Lamp NOT included
- 12V AC or DC transformer required

IP RATING

- IP54 weatherproof

DIMENSIONS

SE7258

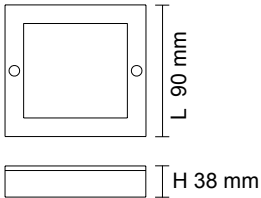

SE7259

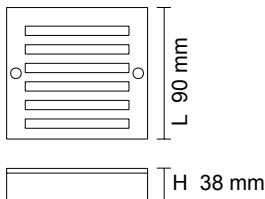

SE7260

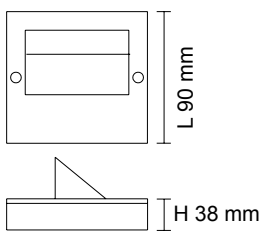

LAMP OPTIONS

Model No.	Input	Lamp Base	Fitting Colour
SE7258 SN	12V	G4	Satin Nickel
SE7259 SL	12V	G4	Silver
SE7259 SN	12V	G4	Satin Nickel
SE7260 SL	12V	G4	Silver



LED WALL LIGHT

S9355 CUBIC

CONSTRUCTION

- Premium grade aluminium body
- Powder coated finish
- Tempered glass diffuser
- High output LED chips
- Up & down beam
- Constant current LED driver fitted

IP RATING

- IP54 weatherproof

DIMENSIONS

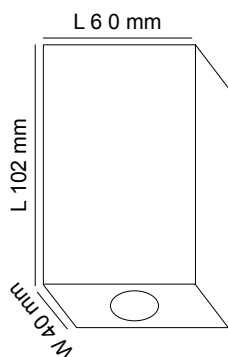

Model No.	Input	Power	Lumen	CCT	CRI	Beam Angle	Dimmable	Installation	Fitting Colour
S9355WW/WH	240V	2 x 1W	50lm	3000K	>80	70° / narrow beam	No	Surface Mounted	White
S9355WW/BK	240V	2 x 1W	50lm	3000K	>80	70° / narrow beam	No	Surface Mounted	Black

LED WALL LIGHT

SE7031, SE7033 MAXI

CONSTRUCTION

- Die-cast aluminium body
- Powder coated finish
- Tempered glass cover
- E27 lamp base
- Lamp not included

IP RATING

- IP54 weatherproof

LAMP OPTIONS

- LG3, LG5
- LGS4, LGS8
- LT407, LT409
- LCA35, LFR35
- LPAR20
- LR63

DIMENSIONS

SE7031

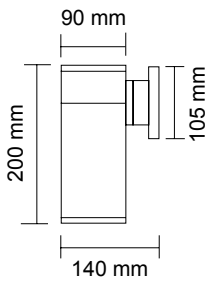

SE7033

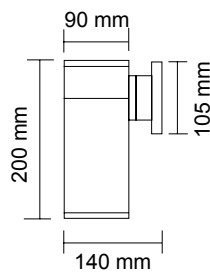

Model No.	Input	Fitting Colour
SE7031 BK	240V	Black
SE7031 SL	240V	Silver
SE7033 BK	240V	Black

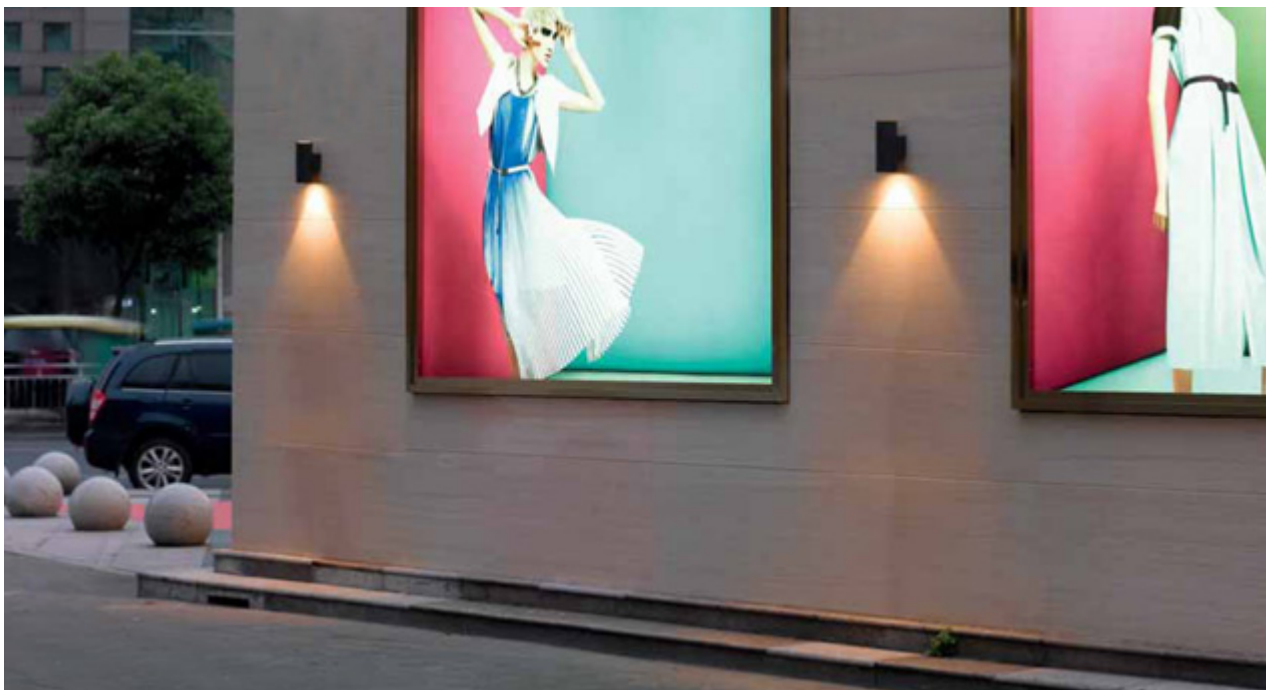

LED WALL LIGHT

SE7133, SE7134 ETON

CONSTRUCTION

- Die-cast aluminium body
- Powder coated finish
- Tempered glass cover
- GU10 lamp base
- Lamp not included

IP RATING

- IP54 weatherproof

LAMP OPTIONS

- GU10L350
- GU10L550
- GU10LR750
- GU10LA750

DIMENSIONS

SE7133

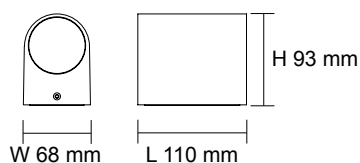

SE7134

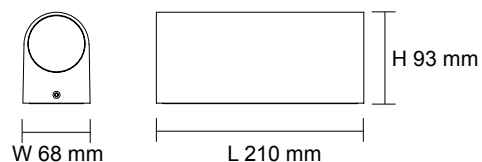

SE7133



SE7134

Model No.	Input	Fitting Colour
SE7133BK GU10	240V	Black
SE7133SL GU10	240V	Silver
SE7134BK GU10	240V	Black
SE7134SL GU10	240V	Silver

LED WALL LIGHT

SE7121, SE7122, SE7123, SE7128, SE7129, SE7130 BONDI

CONSTRUCTION

- Machined 316L grade stainless steel body or 304 grade stainless steel body or die cast aluminium body
- Powder coated finish (Black, Silver)
- Tempered glass cover
- GU10 lamp base
- Lamp not included

IP RATING

- IP65 weatherproof

LAMP OPTIONS

- GU10L350
- GU10L550
- GU10LR750
- GU10LA750

DIMENSIONS

SE7121/GU10
SE7128/GU10

SE7122/GU10
SE7129/GU10

SE7123/GU10
SE7130/GU10

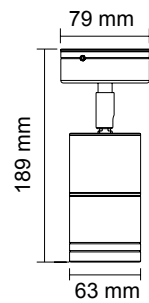
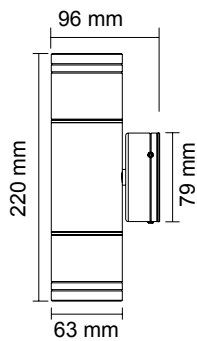
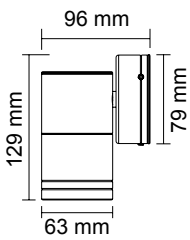

Model No.	Input	Material	Fitting Colour
SE7121SLS GU10	240V	Machined 316L grade stainless steel	Stainless Steel
SE7121BK GU10	240V	Die cast aluminium	Black
SE7121SL GU10	240V	Die cast aluminium	Silver
SE7128GU10	240V	304 grade stainless steel	Stainless Steel
SE7122SLS GU10	240V	Machined 316L grade stainless steel	Stainless Steel
SE7122BK GU10	240V	Die cast aluminium	Black
SE7122SL GU10	240V	Die cast aluminium	Silver
SE7129GU10	240V	304 grade stainless steel	Stainless Steel
SE7123SLS GU10	240V	Machined 316L grade stainless steel	Stainless Steel
SE7123BK GU10	240V	Die cast aluminium	Black
SE7123SL GU10	240V	Die cast aluminium	Silver
SE7130GU10	240V	304 grade stainless steel	Stainless Steel



LED WALL LIGHT

SL7221, SL7222 NEW BONDI

CONSTRUCTION

- Premium aluminium body
- Powder coated finish
- Tempered glass cover
- GU10 lamp base
- Lamp not included

IP RATING

- IP65 weatherproof

LAMP OPTIONS

- GU10L350
- GU10L550
- GU10LR750
- GU10LA750

DIMENSIONS

SL7221GU

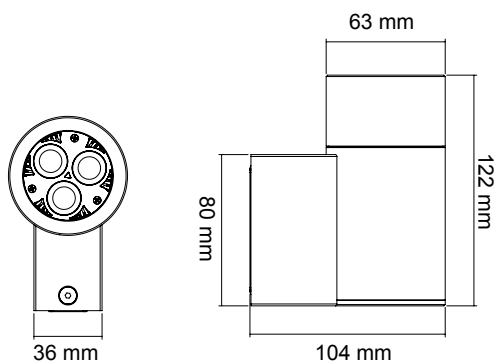

SL7222GU

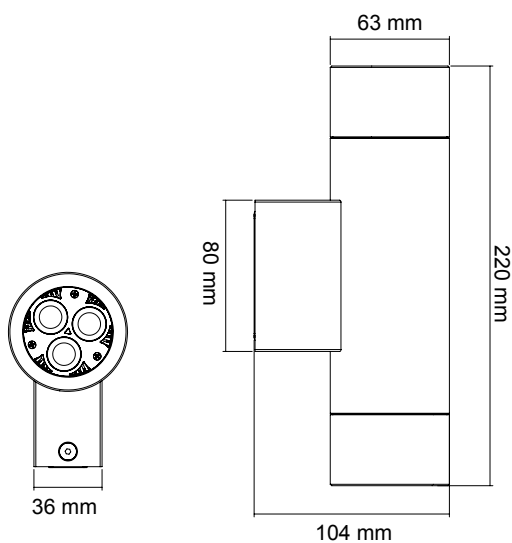

Model No.	Input	Fitting Colour
SL7221GU AS	240V	Anodized Silver
SL7221GU BK	240V	Silver
SL7221GU SL	240V	Black
SL7222GU AS	240V	Anodized Silver
SL7222GU BK	240V	Silver
SL7222GU SL	240V	Black



LED WALL LIGHT

SE7131, SE7132 NEW FLINDERS WALL

CONSTRUCTION

- Premium aluminium body
- Powder coated finish
- Tempered glass cover
- GU10 lamp base
- Lamp not included

IP RATING

- IP54 weatherproof

LAMP OPTIONS

- GU10L350
- GU10L550
- GU10LR750
- GU10LA750

DIMENSIONS

SE7131

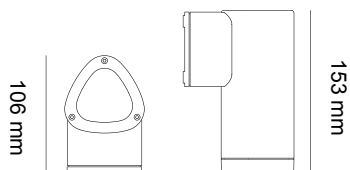

SE7132

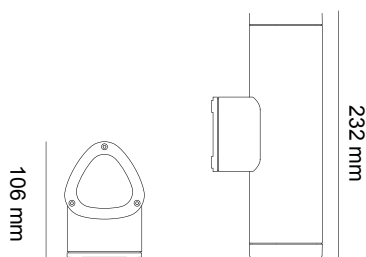

SE7131



SE7132

Model No.	Input	Fitting Colour
SE7131BK GU10	240V	Black
SE7131CB GU10	240V	Charcoal Black
SE7132BK GU10	240V	Black
SE7132CB GU10	240V	Charcoal Black

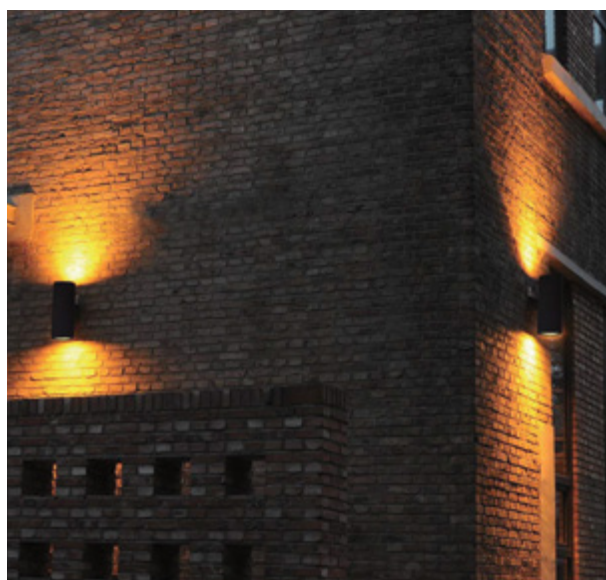

LED POST LIGHT

SE7061 NEW FLINDERS POST

CONSTRUCTION

- Extruded aluminium body
- Powder coated finish
- Opal polycarbonate diffuser
- GX53 LED lamp included or built-in low voltage SMD LED chips (12V AC or DC LED driver required)

IP RATING

- IP54 weatherproof

DIMENSIONS

SE7061/300

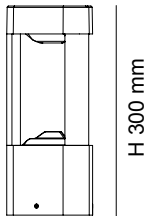

H 300 mm

SE7061800

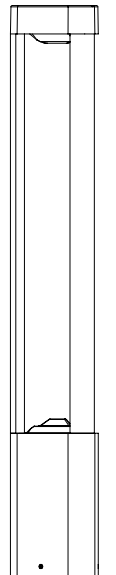

H 800 mm

SE7061/500

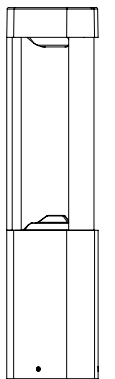

H 500 mm

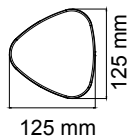

125 mm



SE7061/300

SE7061/500

SE7061/800

Model No.	Input	Power	Lumen	CCT	Lamp Base	Fitting Colour
SE7061/300 BK	240V	3W	250lm	5500K	GX53	Black
SE7061/300 CB	240V	3W	250lm	5500K	GX53	Charcoal Black
SE7061/300 LV BK	12V	6W	500lm	5500K	N/A	Black
SE7061/300 LV CB	12V	6W	500lm	5500K	N/A	Charcoal Black
SE7061/500 BK	240V	3W	250lm	5500K	GX53	Black
SE7061/500 CB	240V	3W	250lm	5500K	GX53	Charcoal Black
SE7061/500 LV BK	12V	6W	500lm	5500K	N/A	Black
SE7061/500 LV CB	12V	6W	500lm	5500K	N/A	Charcoal Black
SE7061/800 BK	240V	3W	250lm	5500K	GX53	Black
SE7061/800 CB	240V	3W	250lm	5500K	GX53	Charcoal Black
SE7061/800 LV BK	12V	6W	500lm	5500K	N/A	Black
SE7061/800 LV CB	12V	6W	500lm	5500K	N/A	Charcoal Black



LED WALL LIGHT

SE7062 LACHLAN WALL

CONSTRUCTION

- Die-cast aluminium body
- Powder coated finish
- Tempered glass diffuser
- Built-in high output LED chip
- Constant current LED driver fitted

IP RATING

- IP54 weatherproof

DIMENSIONS

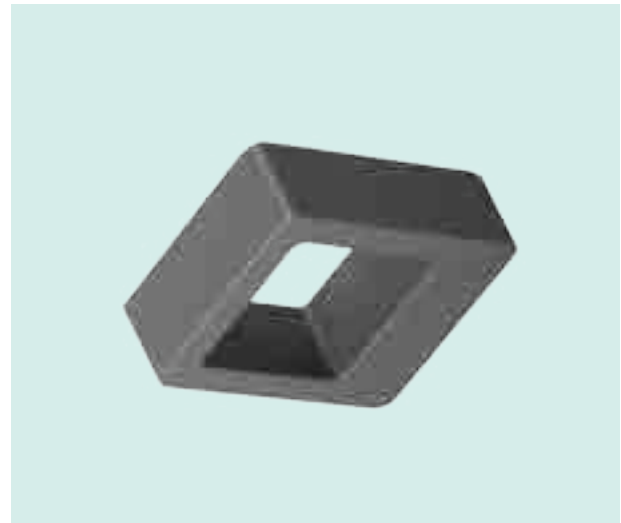
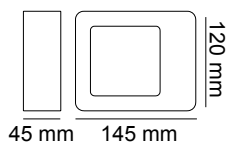

Model No.	Input	Power	Lumen	CCT	CRI	Beam Angle	Fitting Colour
SE7062 BK	240V	3W	230lm	5500K	>80	120° x 2	Black
SE7062 CB	240V	3W	230lm	5500K	>80	120° x 2	Charcoal Black



LED POST LIGHT

SE7062 LACHLAN POST

CONSTRUCTION

- Die-cast aluminium body
- Powder coated finish
- Tempered glass diffuser
- Built-in high output LED chip
- Constant current LED driver fitted

IP RATING

- IP54 weatherproof

DIMENSIONS

SE7062/300

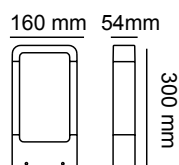

SE7062/300

SE7062/650

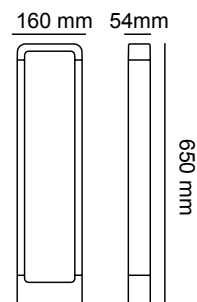

SE7062/650

Model No.	Input	Power	Lumen	CCT	CRI	Fitting Colour
SE7062/300 BK	240V	5W	400lm	5500K	>80	Black
SE7062/300 CB	240V	5W	400lm	5500K	>80	Charcoal Black
SE7062/650 BK	240V	5W	400lm	5500K	>80	Black
SE7062/650 CB	240V	5W	400lm	5500K	>80	Charcoal Black



LED WALL & POST LIGHT

SE7006, SE7016

SE7007, SE7017

SE7008, SE7018

SE7009, SE7019

MURRAY I

CONSTRUCTION

- Stainless steel body
- Powder coated finish (black)
- Opal acrylic diffuser
- E27 lamp base
- Lamp NOT included

IP RATING

- IP44 weatherproof

LAMP OPTIONS

- LG3 3W, LG5 5W, LG7 7W, LG9 9W
- LGS4, LGS8, LGS10, LGS11D
- LT407, LT409
- LCA35 3W, LFR35 3W

DIMENSIONS

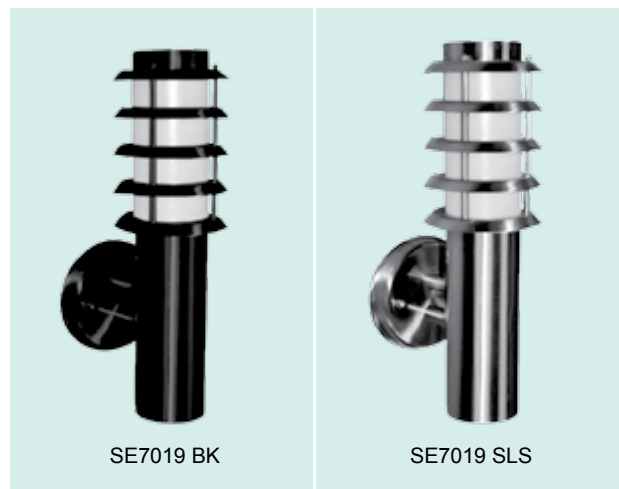
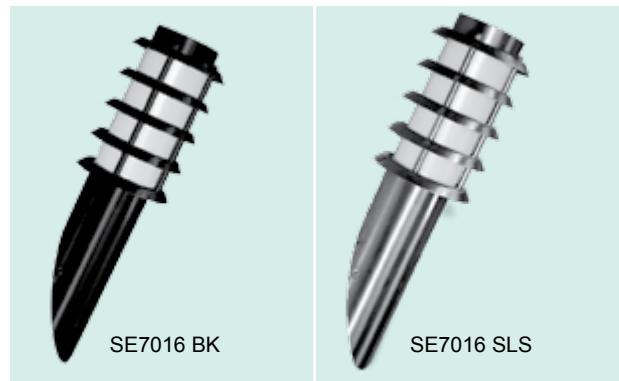
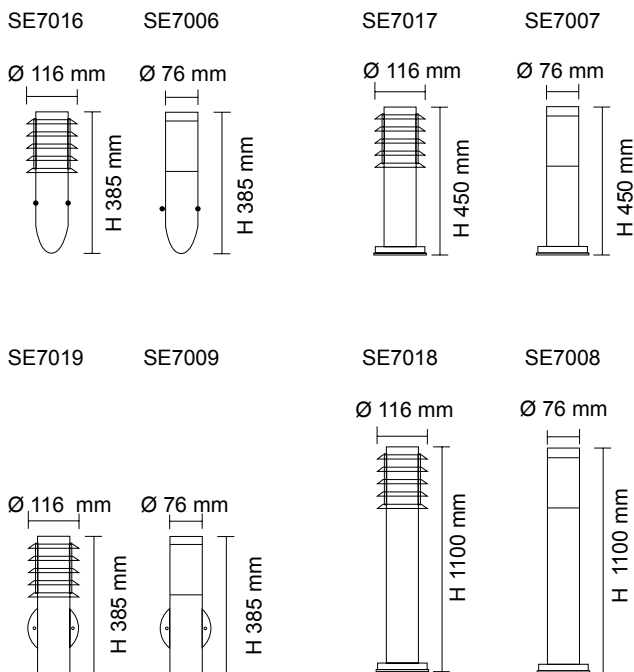

Model No.	Input	Fitting Colour
SE7006 SLS	240V	Stainless Steel
SE7006 BK	240V	Black
SE7016 SLS	240V	Stainless Steel
SE7016 BK	240V	Black
SE7007 SLS	240V	Stainless Steel
SE7007 BK	240V	Black
SE7017 SLS	240V	Stainless Steel
SE7017 BK	240V	Black

Model No.	Input	Fitting Colour
SE7008 SLS	240V	Stainless Steel
SE7008 BK	240V	Black
SE7018 SLS	240V	Stainless Steel
SE7018 BK	240V	Black
SE7009 SLS	240V	Stainless Steel
SE7009 BK	240V	Black
SE7019 SLS	240V	Stainless Steel
SE7019 BK	240V	Black

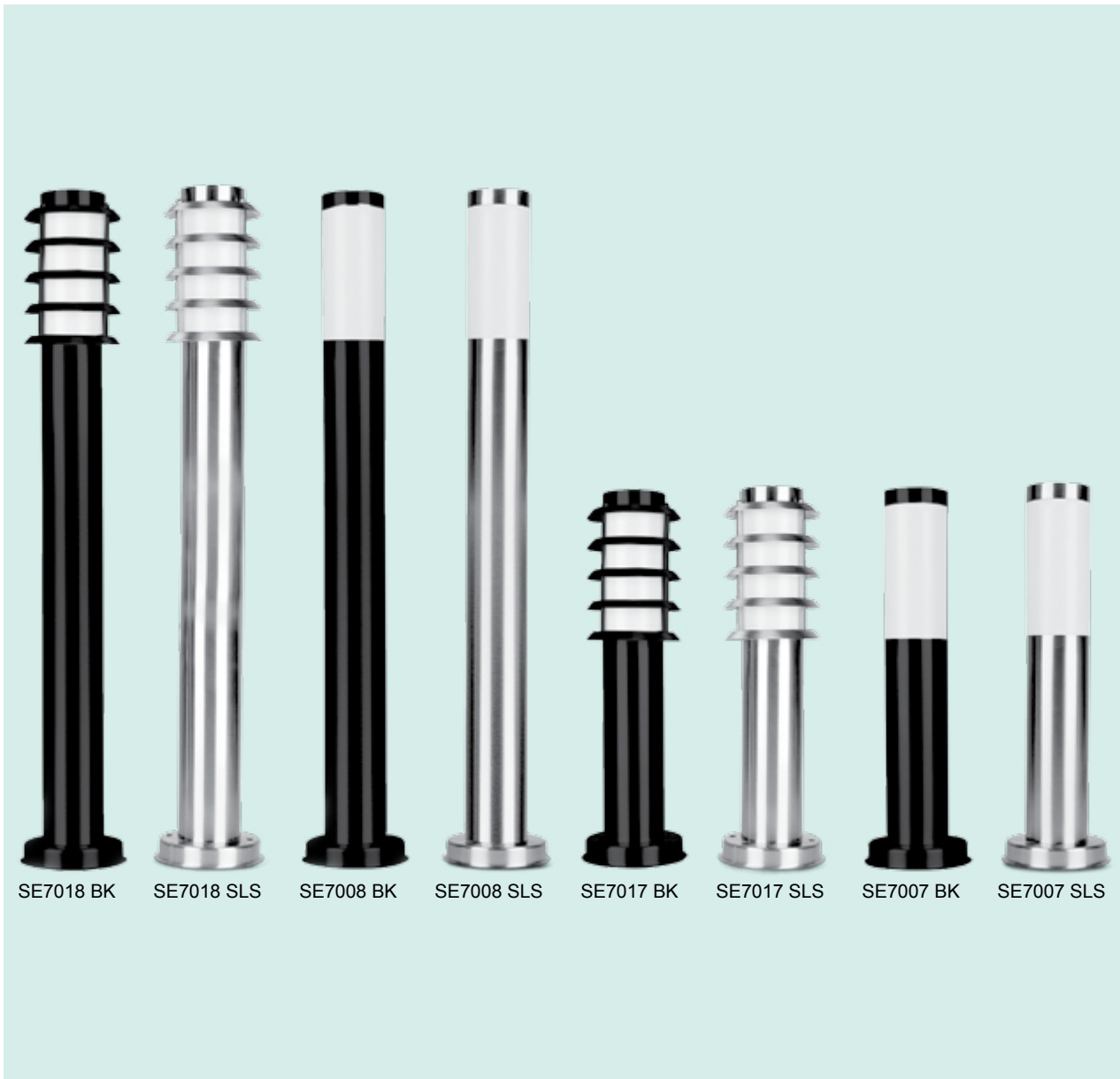

LED WALL & POST LIGHT

SE7085, SE7086 SWAN

CONSTRUCTION

- Stainless steel body
- Clear acrylic diffuser
- E27 lamp base
- Lamp NOT included

IP RATING

- IP44 weatherproof

LAMP OPTIONS

- LG3 3W, LG5 5W, LG7 7W, LG9 9W
- LGS4, LGS8, LGS10, LGS11D
- LT407, LT409
- LCA35 3W, LFR35 3W

Model No.	Input	Fitting Colour
SE7085	240V	Stainless Steel
SE7086/55	240V	Stainless Steel
SE7086/100	240V	Stainless Steel

DIMENSIONS

SE7085

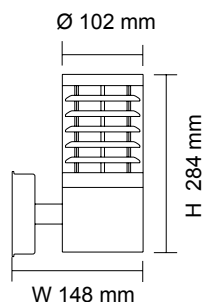

SE7086/55

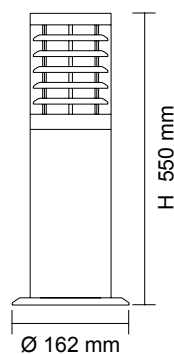

SE7086/100

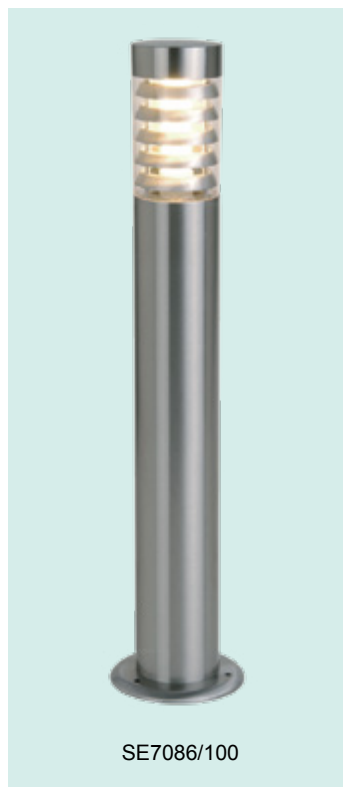
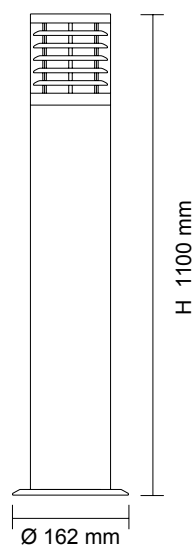

LED POST LIGHT

SE7051, SE7053 YARRA

CONSTRUCTION

- Stainless steel body
- Opal acrylic diffuser
- E27 lamp base
- Lamp NOT included

IP RATING

- IP44 weatherproof

LAMP OPTIONS

- LG3 3W, LG5 5W, LG7 7W, LG9 9W
- LGS4, LGS8, LGS10, LGS11D
- LT407, LT409
- LCA35 3W, LFR35 3W

DIMENSIONS

SE7051/65

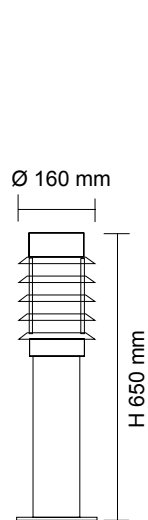

SE7051/100

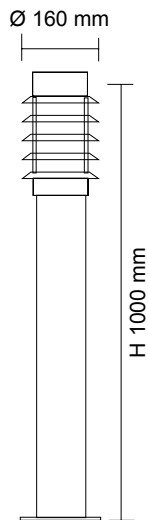

SE7051/65

SE7051/100

Model No.	Input	Fitting Colour
SE7051/65	240V	Stainless Steel
SE7051/100	240V	Stainless Steel
SE7053/65	240V	Stainless Steel
SE7053/100	240V	Stainless Steel



SE7051

SE7053



EXTERIOR COMMERCIAL LEDS



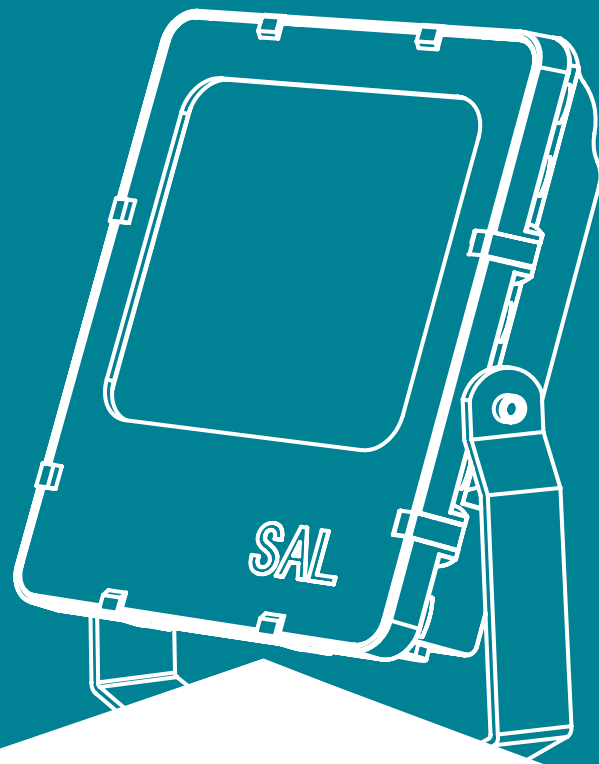

SE7135 MAXI LOUVERED	201	S9341 GROUND MKII	223
SE7136 MAXI SLOT	201	S9342, S9343 GEO	224
SE7137 MAXI EYELID	201	S9344, S9345 GEO	225
SE7138 MAXI GRILLED	201	S9346, S9347 PATHWAY	226
SE7139 MAXI PLAIN	201	S9348, S9349 PATHWAY	227
SE7140 LOUVERED	203	S9351, S9352 PATHWAY	228
SE7141 SLOT	203	S9353, S9354 TORCH	229
SE7142 PLAIN	203	SE7079 DECOSTAR	230
SE7143 RECTANGLE	205	SE7099 MAXISTAR	231
SE7144 SQUARE	205	SHB14/120, SHB14/120MD, SHB14/120PD	
SE7145 SCOOP	206	MINI SATELLITE	233
SE7146 QUARTER	207	SHB14/200, SHB14/200 MD,	
SE7147 MINI STEIN	208	SHB14/300, SHB14/300 MD MAXI SATELLITE	234
SE7148 STEIN	209	SHB22/140, SHB22/240 EAGLE	235
SE7088 ANGLE	210	SHP100/60, SHP100/90, SHP100/120 SPARK	236
SE7089 BRONX	211	SE7103, SE7104, SE7105, SE7106 BOLLARD	237
SL9712 VENICE	212	SLA7102, SE7102/LGLS BOLLARD	238
SL9712/40 VENICE	213		
SL9717 DAYTONA	214		
SL9718 PORTLAND	215		
SL9719SQ MEMPHIS SQUARE	216		
SL9719RD MEMPHIS ROUND	216		
SE7087L REC-BUNKER	217		
SE7081L, SE7082L COOPER	218		
SE7083L, SE7084L COOPER	219		
SL9721 KEW LED	221		

LED BRICK WALL LIGHT

SE7135 MAXI LOUVERED

SE7136 MAXI SLOT

SE7137 MAXI EYELID

SE7138 MAXI GRILLED

SE7139 MAXI PLAIN

CONSTRUCTION

- Die-cast aluminium body and powder coated face cover (SE7135, SE3136, SE3137)
- Die-cast aluminium body and stainless steel face cover (SE7138, SE3139)
- Opal polycarbonate diffuser
- High efficiency SMD LED chips
- Built in LED driver
- Moulding shaped silicone gasket
- IP68 PG9 PVC cable gland
- Stainless steel allen screws
- ABS installation canister included

APPLICATIONS

- Walkways
- Stairwells

IP RATING

- IP65 weatherproof

DIMENSIONS

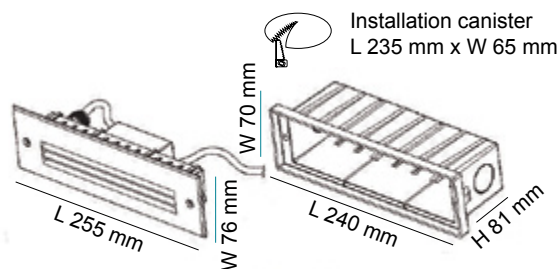

PHOTOMETRIC DATA

Unit: cd SE7135 C0/C180 ———
C90/C270 ———

SE7136

SE7137

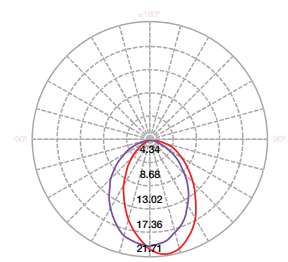
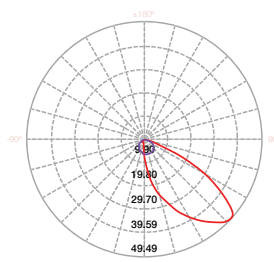
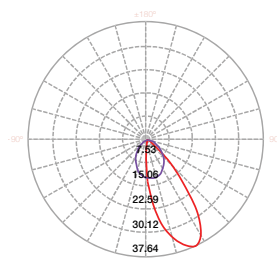

INSTALLATION CANISTER INSTRUCTIONS

- Picture-“A” is the support plate used during the construction installation process to prevent deformation of the installation canister
- Load as per A1, A2
- Please remove the support plate (A1 & A2) from the installation canister before final installation

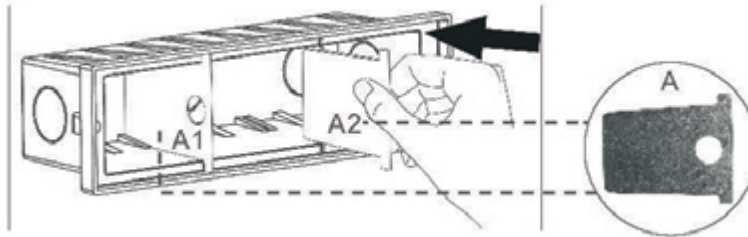

Model No.	Input	Power	Lumen	CCT	CRI	Fitting Colour	IK Rating
SE7135WW/BK	240V	7W	80lm	3000K	>80	Black	09
SE7135WW/SL	240V	7W	80lm	3000K	>80	Silver	09
SE7135CW/BK	240V	7W	80lm	4000K	>80	Black	09
SE7135CW/SL	240V	7W	80lm	4000K	>80	Silver	09

Model No.	Input	Power	Lumen	CCT	CRI	Fitting Colour	IK Rating
SE7136WW/BK	240V	7W	60lm	3000K	>80	Black	10
SE7136WW/SL	240V	7W	60lm	3000K	>80	Silver	10
SE7136CW/BK	240V	7W	60lm	4000K	>80	Black	10
SE7136CW/SL	240V	7W	60lm	4000K	>80	Silver	10

Model No.	Input	Power	Lumen	CCT	CRI	Fitting Colour	IK Rating
SE7137WW/BK	240V	7W	50lm	3000K	>80	Black	09
SE7137WW/SL	240V	7W	50lm	3000K	>80	Silver	09
SE7137CW/BK	240V	7W	50lm	4000K	>80	Black	09
SE7137CW/SL	240V	7W	50lm	4000K	>80	Silver	09

Model No.	Input	Power	Lumen	CCT	CRI	Fitting Colour	IK Rating
SE7138WW	240V	7W	80lm	3000K	>80	Stainless Steel	09
SE7138CW	240V	7W	80lm	4000K	>80	Stainless Steel	09

Model No.	Input	Power	Lumen	CCT	CRI	Fitting Colour	IK Rating
SE7139WW	240V	7W	140lm	3000K	>80	Stainless Steel	10
SE7139CW	240V	7W	140lm	4000K	>80	Stainless Steel	10

SE7138

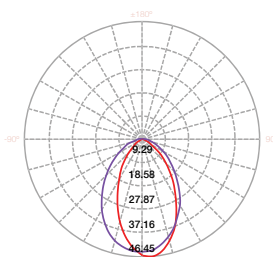

SE7139

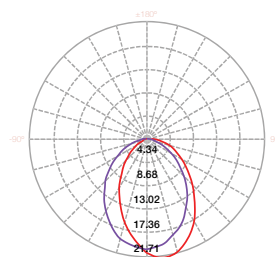

LED WALL LIGHT

SE7140 LOUVERED

SE7141 SLOT

SE7142 PLAIN

CONSTRUCTION

- Die-cast aluminium body and face cover
- Powder coated finish
- Opal polycarbonate diffuser
- High efficiency SMD LED chips
- Built in LED driver
- Moulding shaped silicone gasket
- IP67 nickel coated copper cable gland
- Stainless steel allen screws
- PVC installation canister included

APPLICATIONS

- Walkways
- Stairwells

IP RATING

- IP65 weatherproof

DIMENSIONS

SE7140 & SE7141

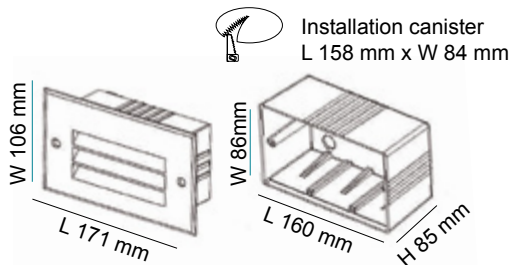

SE7142

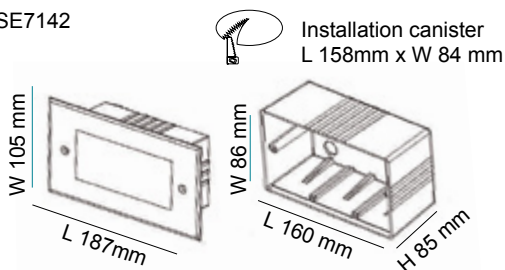

SE7140



SE7141



SE7142

INSTALLATION CANISTER INSTRUCTIONS

- Picture-“A” is the support plate used during the construction installation process to prevent deformation of the installation canister
- Load as per A1, A2
- Please remove the support plate (A1 & A2) from the installation canister before final installation

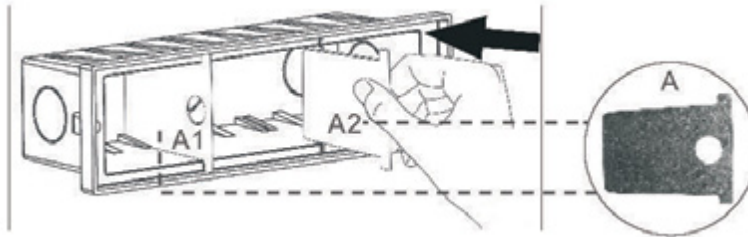

Model No.	Input	Power	Lumen	CCT	CRI	Fitting Colour	IK Rating
SE7140WW/BK	240V	3W	50lm	3000K	>80	Black	10
SE7140WW/SL	240V	3W	50lm	3000K	>80	Silver	10
SE7140CW/BK	240V	3W	50lm	4000K	>80	Black	10
SE7140CW/SL	240V	3W	50lm	4000K	>80	Silver	10

Model No.	Input	Power	Lumen	CCT	CRI	Fitting Colour	IK Rating
SE7141WW/BK	240V	3W	60lm	3000K	>80	Black	10
SE7141WW/SL	240V	3W	60lm	3000K	>80	Silver	10
SE7141CW/BK	240V	3W	60lm	4000K	>80	Black	10
SE7141CW/SL	240V	3W	60lm	4000K	>80	Silver	10

Model No.	Input	Power	Lumen	CCT	CRI	Fitting Colour	IK Rating
SE7142WW/BK	240V	3W	80lm	3000K	>80	Black	10
SE7142WW/SL	240V	3W	80lm	3000K	>80	Silver	10
SE7142CW/BK	240V	3W	80lm	4000K	>80	Black	10
SE7142CW/SL	240V	3W	80lm	4000K	>80	Silver	10

PHOTOMETRIC DATA

Unit: cd SE7140 C0/C180 —
C90/C270 —

SE7141

SE7142

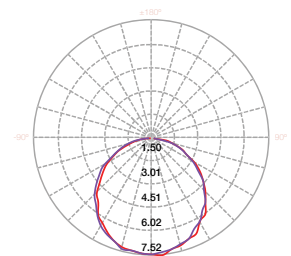
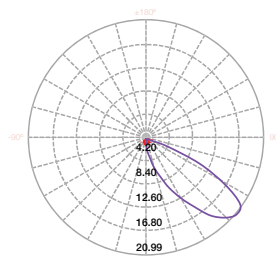
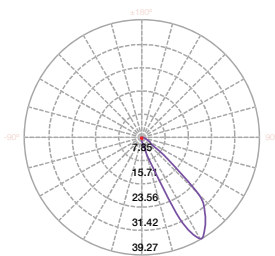

LED WALL LIGHTS

SE7143 RECTANGLE

SE7144 SQUARE

CONSTRUCTION

- Die-cast aluminium body and face cover
- Powder coated finish
- Opal polycarbonate diffuser
- High efficiency SMD LED chips
- Built in LED driver
- Moulding shaped silicone gasket
- IP67 nickel coated copper cable gland
- Stainless steel allen screws
- PVC installation canister included

APPLICATIONS

- Walkways
- Stairwells

IP RATING

- IP65 weatherproof



DIMENSIONS

SE7143 Installation canister L 96 mm x W 158 mm

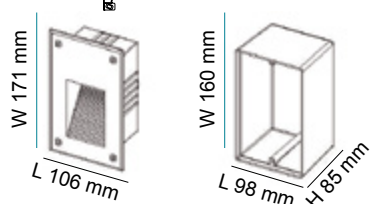

SE7144 Installation canister L 150 mm x W 150 mm

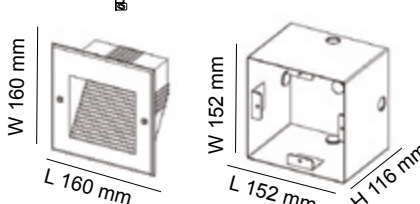

Model No.	Input	Power	Lumen	CCT	CRI	Light Source	Fitting Colour	IK Rating
SE7143WW/BK	240V	3W	70lm	3000K	>80	20 x SMD3528	Black	10
SE7143WW/SL	240V	3W	70lm	3000K	>80	20 x SMD3528	Silver	10
SE7143CW/BK	240V	3W	70lm	4000K	>80	20 x SMD3528	Black	10
SE7143CW/SL	240V	3W	70lm	4000K	>80	20 x SMD3528	Silver	10

Model No.	Input	Power	Lumen	CCT	CRI	Light Source	Fitting Colour	IK Rating
SE7144WW/BK	240V	2W	60lm	3000K	>80	18 x SMD3020	Black	10
SE7144WW/SL	240V	2W	60lm	3000K	>80	18 x SMD3020	Silver	10
SE7144CW/BK	240V	2W	60lm	4000K	>80	18 x SMD3020	Black	10
SE7144CW/SL	240V	2W	60lm	4000K	>80	18 x SMD3020	Silver	10

PHOTOMETRIC DATA

Unit: cd SE7143 C0/C180 C90/C270

SE7144

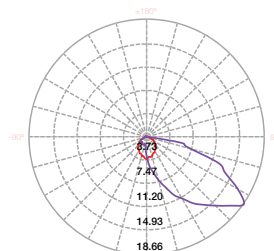
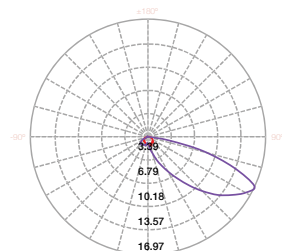

LED WALL LIGHT

SE7145 SCOOP

CONSTRUCTION

- Die-cast aluminium body
- Powder coated finish
- Tempered glass cover
- High efficiency COB LED chip
- High performance multi-reflector system
- Stainless steel allen screws
- Constant current LED driver fitted

APPLICATIONS

- Walkways
- Stairwells
- Hallways

IP RATING

- IP65 weatherproof

DIMENSIONS

SE7145

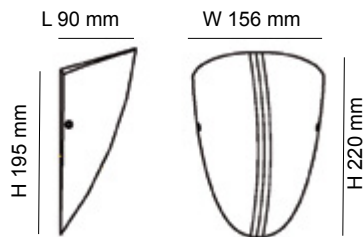

Model No.	Input	Power	Lumen	CCT	CRI	Beam Angle	Fitting Colour
SE7145WW/BK	240V	15W	800lm	3000K	>80	30°	Black
SE7145WW/SL	240V	15W	800lm	3000K	>80	30°	Silver
SE7145CW/BK	240V	15W	900lm	4000K	>80	30°	Black
SE7145CW/SL	240V	15W	900lm	4000K	>80	30°	Silver

PHOTOMETRIC DATA

Unit: cd C0/C180 —
C90/C270 —

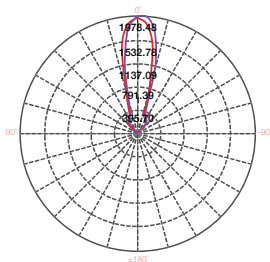

LED WALL LIGHT SE7146 QUARTER

CONSTRUCTION

- Die-cast aluminium body
- Powder coated finish
- Tempered glass cover
- High efficiency COB LED chip
- High performance multi-reflector system
- Stainless steel allen screws
- Constant current LED driver fitted

APPLICATIONS

- Walkways
- Stairwells
- Hallways

IP RATING

- IP65 weatherproof

DIMENSIONS

SE7146

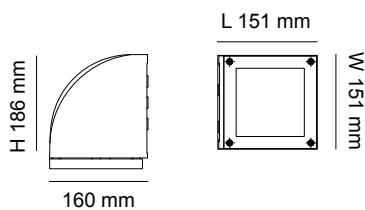

Model No.	Input	Power	Lumen	CCT	CRI	Beam Angle	Fitting Colour
SE7146WW/BK	240V	16W	1150lm	3000K	>80	25°	Black
SE7146WW/CB	240V	16W	1150lm	3000K	>80	25°	Charcoal Black
SE7146CW/BK	240V	16W	1200lm	4000K	>80	25°	Black
SE7146CW/CB	240V	16W	1200lm	4000K	>80	25°	Charcoal Black

PHOTOMETRIC DATA

Unit: cd C0/C180 ———
C90/C270 ———

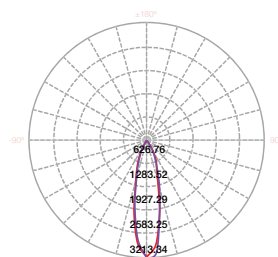

www.sal.net.au

LED WALL LIGHT

SE7147 MINI STEIN

CONSTRUCTION

- Die-cast aluminium body
- Powder coated finish
- Tempered glass cover
- High efficiency COB LED chip
- High performance multi-reflector system
- Constant current LED driver fitted
- Stainless steel allen screws

APPLICATIONS

- Walkways
- Stairwells
- Hallways

IP RATING

- IP65 weatherproof

DIMENSIONS

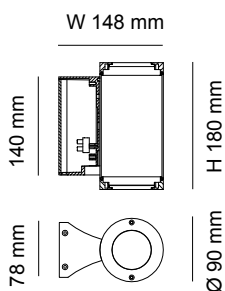

Model No.	Input	Power	Lumen	CCT	CRI	Beam Angle	Fitting Colour
SE7147WW/BK	240V	16W	800lm	3000K	>80	25°	Black
SE7147WW/CB	240V	16W	800lm	3000K	>80	25°	Charcoal Black
SE7147CW/BK	240V	16W	800lm	4000K	>80	25°	Black
SE7147CW/CB	240V	16W	800lm	4000K	>80	25°	Charcoal Black

PHOTOMETRIC DATA

Unit: cd C0/C180 ———
C90/C270 ———

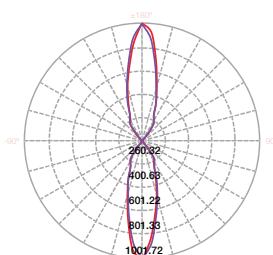

LED WALL LIGHT

SE7148 STEIN

CONSTRUCTION

- Die-cast aluminium body
- Powder coated finish
- Tempered glass cover
- High efficiency COB LED chip
- High performance multi-reflector system
- Constant current LED driver fitted
- Stainless steel allen screws

APPLICATIONS

- Walkways
- Stairwells
- Hallways

IP RATING

- IP65 weatherproof

DIMENSIONS

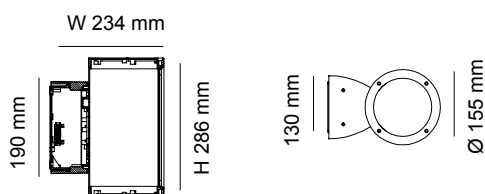

Model No.	Input	Power	Lumen	CCT	CRI	Beam Angle	Fitting Colour
SE7148WW/BK	240V	32W	1600lm	3000K	>80	25°	Black
SE7148WW/CB	240V	32W	1600lm	3000K	>80	25°	Charcoal Black
SE7148CW/BK	240V	32W	1600lm	4000K	>80	25°	Black
SE7148CW/CB	240V	32W	1600lm	4000K	>80	25°	Charcoal Black

Model No.	Input	Power	Lumen	CCT	CRI	Beam Angle	Fitting Colour
SE7148NB/WW BK	240V	32W	1300lm	3000K	>80	25°/Narrow Beam	Black
SE7148NB/WW CB	240V	32W	1300lm	3000K	>80	25°/Narrow Beam	Charcoal Black
SE7148NB/CW BK	240V	32W	1300lm	4000K	>80	25°/Narrow Beam	Black
SE7148NB/CW CB	240V	32W	1300lm	4000K	>80	25°/Narrow Beam	Charcoal Black

PHOTOMETRIC DATA

Unit: cd C0/C180 ———
 C90/C270 ———

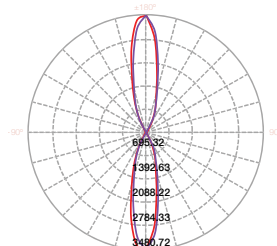

www.sal.net.au

LED WALL/CEILING LIGHT

SE7088 ANGLE

CONSTRUCTION

- Die-cast aluminium body
- Powder coated finish
- Adjustable head 0~90°
- Moulding shaped silicone gasket
- Tempered glass face cover
- High efficiency COB LED chip
- High performance multi-reflector system
- Constant current LED driver fitted

APPLICATIONS

- Walkways
- Hallways
- Porches

IP RATING

- IP65 weatherproof

DIMENSIONS

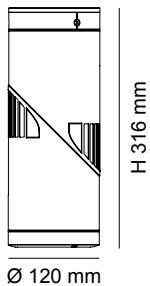

Model No.	Input	Power	Lumen	CCT	CRI	Beam Angle	Fitting Colour
SE7088 BK	240V	18W	1500lm	3000K	>80	40°	Black
SE7088 CB	240V	18W	1500lm	3000K	>80	40°	Charcoal Black

PHOTOMETRIC DATA

Unit: cd C0/C180 —
C90/C270 —

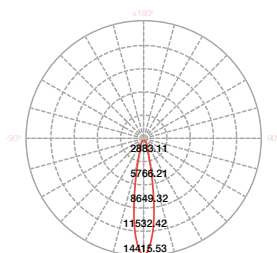

LED WALL LIGHT

SE7089 BRONX

CONSTRUCTION

- Die-cast aluminium body
- Powder coated finish
- Opal polycarbonate diffuser
- High efficiency COB LED chip
- Polished aluminium reflector
- Constant current LED driver fitted
- IP66 PVC cable gland
- Stainless steel allen screws

APPLICATIONS

- Walkways
- Hallways
- Warehouses

SENSOR OPTIONS

- Microwave motion sensor (SMS800)

IP RATING

- IP65 weatherproof

DIMENSIONS

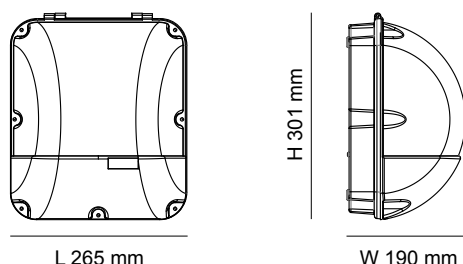

Model No.	Input	Power	Lumen	CCT	CRI	Fitting Colour	IK Rating
SE7089BK	240V	55W	4500lm	5000K	>70	Black	10

PHOTOMETRIC DATA

Unit: cd
 C0/C180 ———
 C90/C270 ———

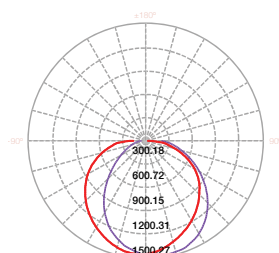

LED OYSTER LIGHT

SL9712 VENICE

CONSTRUCTION

- Polycarbonate base and ring
- Double insulation
- Opal polycarbonate diffuser
- High efficiency SMD LED chips
- Constant current LED driver fitted

IP RATING

- IP64 weatherproof

DIMMING OPTIONS

- Analogue dimming (Trailing edge, 1-10V dimming)
- Digital dimming (DSI, DALI)

DIMENSIONS

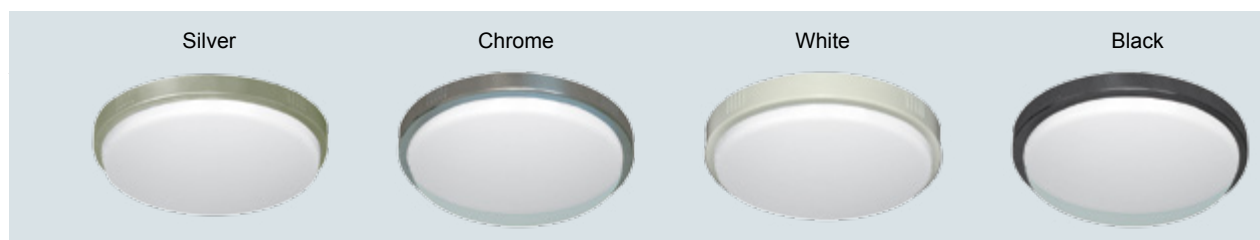
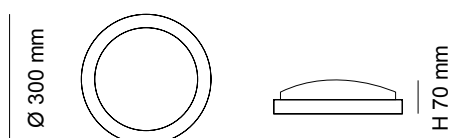

Model No.	Input	Power	Lumen	CCT	CRI	Fitting Colour
SL9712 WH	240V	13W	900lm	4000K	>85	White
SL9712 CH	240V	13W	900lm	4000K	>85	Chrome
SL9712 SL	240V	13W	900lm	4000K	>85	Silver
SL9712 BL	240V	13W	900lm	4000K	>85	Black

PHOTOMETRIC DATA

Unit: cd, C0/C180 ———
C90/C270 ———

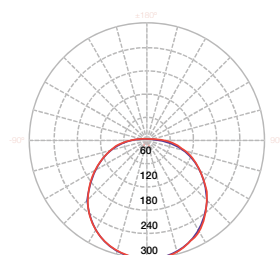

LED OYSTER LIGHT

SL9712/40 VENICE

CONSTRUCTION

- Polycarbonate base and ring
- Double insulation
- Opal polycarbonate diffuser
- High efficiency SMD LED chips
- Constant current LED driver fitted

IP RATING

- IP64 weatherproof

DIMMING OPTIONS

- Analogue dimming (Trailing edge, 1-10V dimming)
- Digital dimming (DSI, DALI)

SENSOR OPTIONS

- Microwave motion sensor (SMS800)



DIMENSIONS

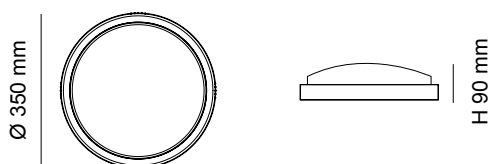

AVAILABLE RING COLOURS

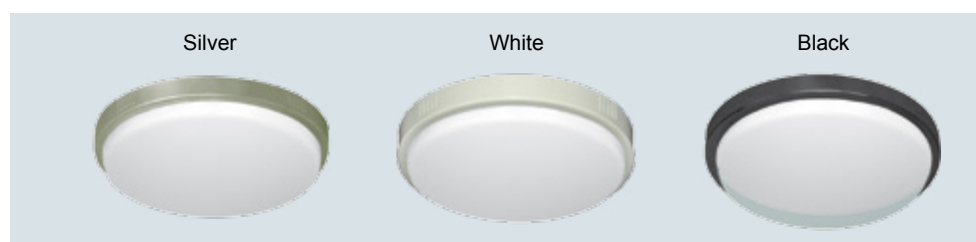

Model No.	Input	Power	Lumen	CCT	CRI	Fitting Colour
SL9712/40 SL	240V	24W	1800lm	4000K	>80	Silver
SL9712/40 WH	240V	24W	1800lm	4000K	>80	White
SL9712/40 BK	240V	24W	1800lm	4000K	>80	Black

LED OYSTER LIGHT

SL9717 DAYTONA

CONSTRUCTION

- Polycarbonate base and ring
- Double insulation
- Opal polycarbonate diffuser
- High efficiency SMD LED chips
- Constant current LED driver fitted

IP RATING

- IP65 weatherproof

DIMMING OPTIONS

- Analogue dimming (Trailing edge)

EMERGENCY OPTIONS

- Compliant to AS2293

SENSOR OPTIONS

- Microwave motion sensor (SMS800)



DIMENSIONS

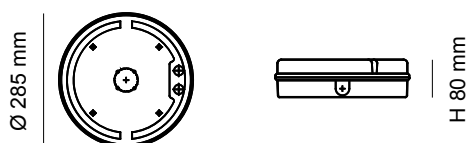

Model No.	Input	Power	Lumen	CCT	CRI	Fitting Colour	IK Rating
SL9717WH	240V	20W	1800lm	5000K	>80	White	IK10

PHOTOMETRIC DATA

Unit: cd

C0/C180 ———

C90/C270 ———

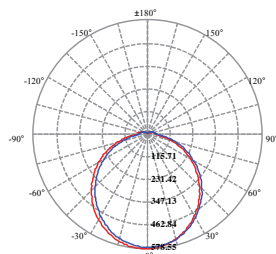

LED OYSTER LIGHT SL9718 PORTLAND

CONSTRUCTION

- Polycarbonate base and ring
- Double insulation
- Opal polycarbonate diffuser
- High efficiency SMD LED chips
- Constant current LED driver fitted

IP RATING

- IP54 weatherproof

DIMMING OPTIONS

- Analogue dimming (Trailing edge)

SENSOR OPTIONS

- Microwave motion sensor (SMS800)



DIMENSIONS

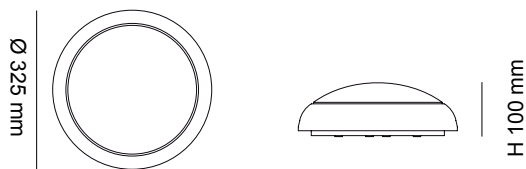

Model No.	Input	Power	Lumen	CCT	CRI	Fitting Colour
SL9718WH	240V	20W	1800lm	5000K	>80	White

PHOTOMETRIC DATA

Unit: cd

C0/C180 ————
C90/C270 ————

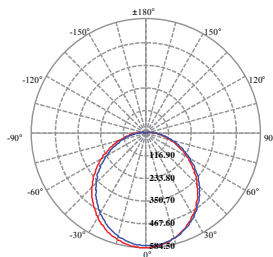

LED OYSTER LIGHT

SL9719SQ MEMPHIS SQUARE

SL9719RD MEMPHIS ROUND

CONSTRUCTION

- Die-cast aluminium body
- Frosted prismatic polycarbonate diffuser
- Stainless steel allen screws
- Moulding shaped silicone gasket
- High efficiency SMD LED chips
- Constant current LED driver fitted

APPLICATIONS

- Walkways
- Stairwells
- Car Parks
- Stations

EMERGENCY OPTIONS

- Compliant to AS2293

SENSOR OPTIONS

- Microwave motion sensor (SMS800)

IP RATING

- IP65 weatherproof

DIMENSIONS

SL9719SQ

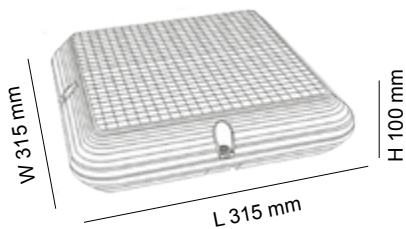

SL9719SQ



SL9719RD

SL9719RD

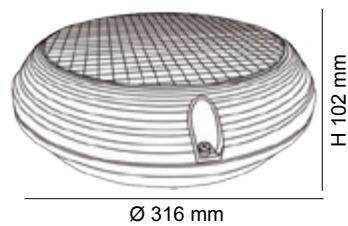

Model No.	Input	Power	Lumen	CCT	CRI	Fitting Colour
SL9719SQ	240V	22W	1700lm	4000K	>80	White

Model No.	Input	Power	Lumen	CCT	CRI	Fitting Colour
SL9719RD	240V	22W	1700lm	4000K	>80	White

LED BUNKER LIGHT

SE7087L REC-BUNKER

CONSTRUCTION

- Die-cast aluminium body
- Powder coated finish
- Opal polycarbonate diffuser
- Stainless steel screws
- Moulding shaped silicon gasket
- Built-in high efficiency SMD LED chips
- Constant current LED driver fitted

APPLICATIONS

- Walkways
- Stairwells
- Car parks
- Stations

IP RATING

- IP54 weatherproof



DIMENSION



Model No.	Input	Power	Lumen	CCT	CRI	Beam Angle	Fitting Colour	IK Rating
SE7087L	240V	18W	1450lm	4000K	>80	90°	White	10

PHOTOMETRIC DATA

Unit: cd C0/C180 —
 C90/C270 —

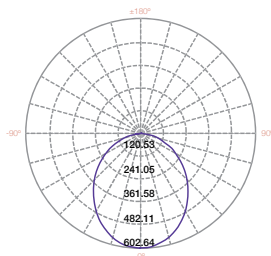

LED BUNKER LIGHTS

SE7081L, SE7082L COOPER

CONSTRUCTION

- Die-cast aluminium body
- Powder coated finish
- Opal polycarbonate diffuser
- Stainless steel allen screws
- Moulding shaped silicon gasket
- High efficiency SMD LED chips
- Constant current LED driver fitted

APPLICATIONS

- Walkways
- Hallways
- Balconies

DIMMING OPTIONS

- Analogue dimming
(Trailing edge, 1-10V dimming)
- Digital dimming (DSI, DALI)

SENSOR OPTIONS

- Microwave motion sensor (SMS800)

IP RATING

- IP65 weatherproof

DIMENSIONS

SE7081L

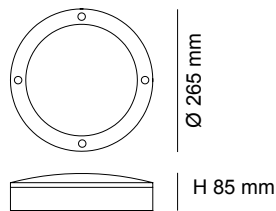

SE7081L

SE7082L

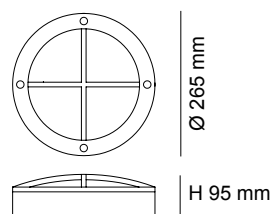

SE7082L

Model No.	Input	Power	Lumen	CCT	CRI	Fitting Colour	IK Rating
SE7081L SL WW	240V	16W	1100lm	3000K	>80	Silver	10
SE7081L SL DL	240V	16W	1100lm	6000K	>80	Silver	10
SE7081L BK WW	240V	16W	1100lm	3000K	>80	Black	10
SE7081L BK DL	240V	16W	1100lm	6000K	>80	Black	10

Model No.	Input	Power	Lumen	CCT	CRI	Fitting Colour	IK Rating
SE7082L SL WW	240V	16W	1000lm	3000K	>80	Silver	10
SE7082L SL DL	240V	16W	1000lm	6000K	>80	Silver	10
SE7082L BK WW	240V	16W	1000lm	3000K	>80	Black	10
SE7082L BK DL	240V	16W	1000lm	6000K	>80	Black	10

PHOTOMETRIC DATA

Unit: cd

SE7081L WW

C0/C180
C90/C270

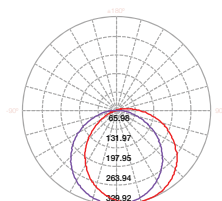

SE7081L DL

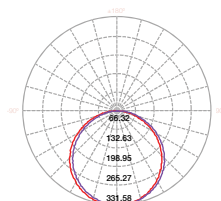

SE7082L WW

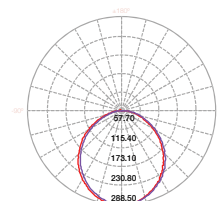

SE7082L DL

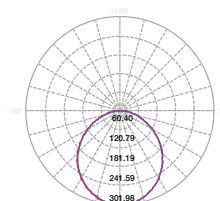

LED BUNKER LIGHTS

SE7083L, SE7084L COOPER

CONSTRUCTION

- Die-cast aluminium body
- Powder coated finish
- Opal polycarbonate diffuser
- Stainless steel allen screws
- Moulding shaped silicon gasket
- High efficiency SMD LED chips
- Constant current LED driver fitted

APPLICATIONS

- Walkways
- Hallways
- Balconies

DIMMING OPTIONS

- Analogue dimming
(Trailing edge, 1-10V dimming)
- Digital dimming (DSI, DALI)

SENSOR OPTIONS

- Microwave motion sensor (SMS800)

IP RATING

- IP65 weatherproof

EMERGENCY OPTIONS

- Compliant to AS2293
- Emergency classification: D32 (SE7083L)
- Emergency classification: D25 (SE7084L)

DIMENSIONS

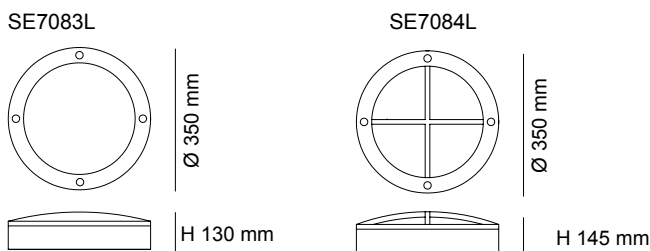

PHOTOMETRIC DATA

Unit: cd SE7083L WW C0/C180 ———
C90/C270 ———

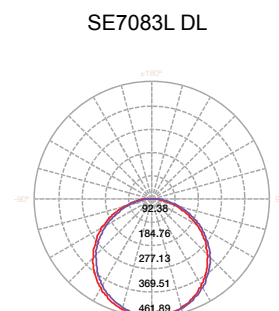
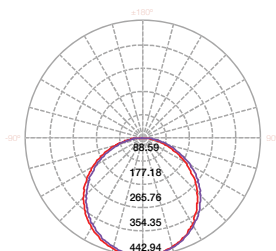

LED BUNKER LIGHTS

Model No.	Input	Power	Lumen	CCT	CRI	Fitting Colour	IK Rating
SE7083L SL WW	240V	23W	1400lm	3000K	>80	Silver	10
SE7083L SL DL	240V	23W	1500lm	6000K	>80	Silver	10
SE7083L BK WW	240V	23W	1400lm	3000K	>80	Black	10
SE7083L BK DL	240V	23W	1500lm	6000K	>80	Black	10

EMERGENCY SPECIFICATION: D32

Model No.	Input	Power	Lumen	CCT	CRI	Fitting Colour	IK Rating
SE7083L/EM/WW/SL	240V	23W/3W	1400lm/250lm	3000K	>80	Silver	10
SE7083L/EM/DL/SL	240V	23W/3W	1500lm/250lm	6000K	>80	Silver	10
SE7083L/EM/WW/BK	240V	23W/3W	1400lm/250lm	3000K	>80	Black	10
SE7083L/EM/DL/BK	240V	23W/3W	1500lm/250lm	6000K	>80	Black	10

Model No.	Input	Power	Lumen	CCT	CRI	Fitting Colour	IK Rating
SE7084L SL WW	240V	23W	1300lm	3000K	>80	Silver	10
SE7084L SL DL	240V	23W	1400lm	6000K	>80	Silver	10
SE7084L BK WW	240V	23W	1300lm	3000K	>80	Black	10
SE7084L BK DL	240V	23W	1400lm	6000K	>80	Black	10

EMERGENCY SPECIFICATION: D25

Model No.	Input	Power	Lumen	CCT	CRI	Fitting Colour	IK Rating
SE7084L/EM/WW/SL	240V	23W/3W	1300lm/230lm	3000K	>80	Silver	10
SE7084L/EM/DL/SL	240V	23W/3W	1400lm/230lm	6000K	>80	Silver	10
SE7084L/EM/WW/BK	240V	23W/3W	1300lm/230lm	3000K	>80	Black	10
SE7084L/EM/DL/BK	240V	23W/3W	1400lm/230lm	6000K	>80	Black	10

PHOTOMETRIC DATA

Unit: cd SE7084L WW

C0/C180 ———
C90/C270 ———

SE7084L DL

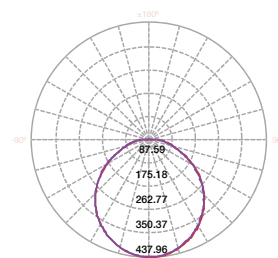
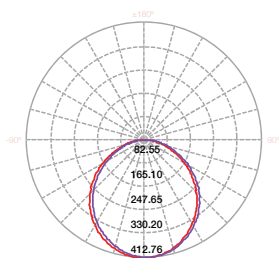

IP65 LED WEATHERPROOF BATTEN

SL9721 KEW LED

CONSTRUCTION

- Rounded shape design vandal proof
- Polycarbonate body & diffuser
- Stainless steel clips & screws
- Built-in high efficiency SMD LED chips
- Constant current LED driver fitted
- Variable wattage switch between 10/20W, 18/35W

IP RATING

- IP65 weatherproof

ACCESSORIES INCLUDED

- Allen key & screws
- PVC cable glands
- Suspension brackets

OPTIONS

- Analogue dimming (trailing edge, 1-10V)
- Digital dimming (DSI, DALI)
- Emergency, compliant to AS2293

SENSOR OPTIONS

- Microwave motion sensor (SMS810)

INSTALLATION TYPE

- Surface mounted
- Suspended (Suspension unit is required)

DIMENSIONS

SL9721/20W



SL9721/35W

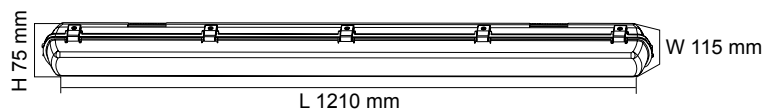

Model No.	Input	Power	Lumen	CCT	CRI	Beam Angle
SL9721/20W WW	240V	10/20W	800/1500lm	3000K	>80	100°
SL9721/20W DL	240V	10/20W	800/1500lm	5000K	>80	100°
SL9721/35W WW	240V	18/35W	1500/3000lm	3000K	>80	100°
SL9721/35W DL	240V	18/35W	1500/3000lm	5000K	>80	100°



LED INGROUND LIGHT

S9341 GROUND MKII

CONSTRUCTION

- Die-cast aluminium body
- Tempered glass diffuser
- 316L stainless steel face cover
- High efficiency LED chips with optical lens
- Constant current LED driver fitted
- Moulding shaped silicone gasket
- IP68 PG9 PVC cable gland
- Stainless steel allen screws
- PVC installation canister included

APPLICATIONS

- Walkways
- Stairwells
- Plazas



GLASS PRESSURE CAPACITY

- >2000KGS

IP RATING

- IP67 weatherproof

DIMENSIONS

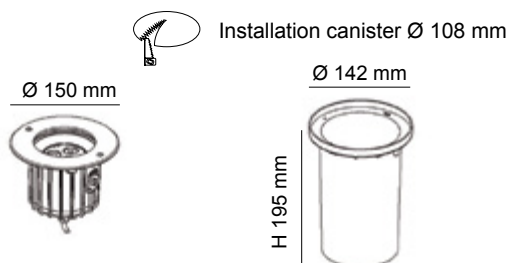

Model No.	Input	Power	Lumen	CCT	CRI	Light Source	Beam Angle	Fitting Colour	IK Rating
S9341WW	240V	8W	350lm	3000K	>80	3 x 2W	30°	Stainless Steel	09
S9341CW	240V	8W	400lm	4000K	>80	3 x 2W	30°	Stainless Steel	09

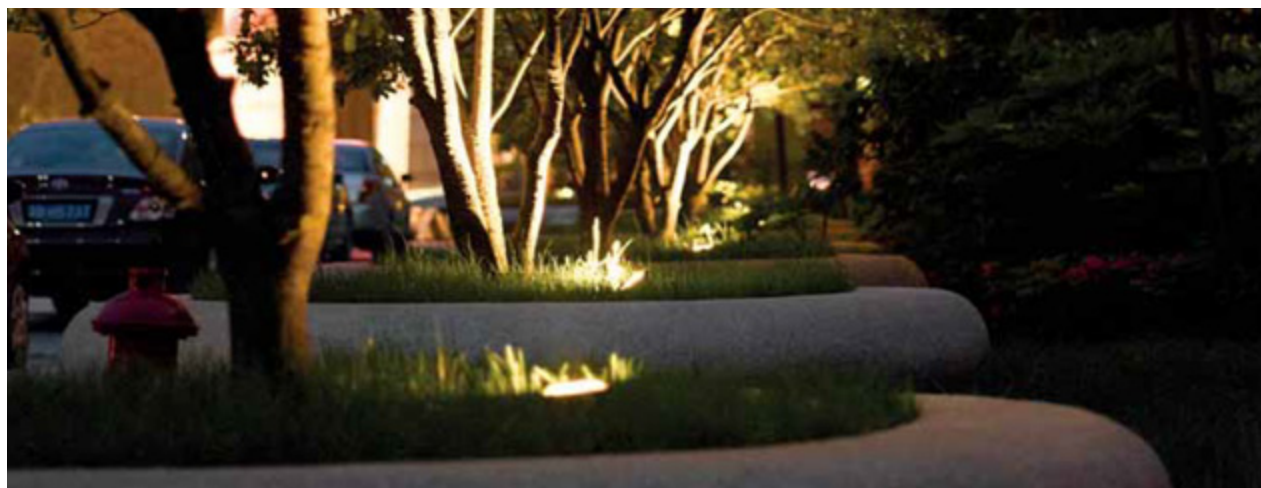

LED FOUR WAY INGROUND LIGHT

S9346, S9347 PATHWAY

CONSTRUCTION

- Die-cast aluminium body
- 316 stainless steel face cover
- Opal polycarbonate diffuser
- High efficiency SMD LED chips
- Constant current LED driver fitted
- Moulding shaped silicone gasket
- IP68 PG9 PVC cable gland
- Stainless steel allen screws
- Installation PVC canister included

APPLICATIONS

- Walkways
- Stairwells
- Plazas

LOADING PRESSURE CAPACITY

- >2000KGS

IP RATING

- IP67 weatherproof

DIMENSIONS

S9346

Ø 116 mm



Ø 74 mm

Ø 102 mm



H 150 mm



S9346

S9347

Ø 173 mm



Ø 119 mm

Ø 157 mm



H 150 mm



S9347

Model No.	Input	Power	Lumen	CCT	CRI	Fitting Colour	IK Rating
S9346WW	240V	4W	160lm	3000K	>80	Stainless Steel	10
S9346CW	240V	4W	160lm	4000K	>80	Stainless Steel	10

Model No.	Input	Power	Lumen	CCT	CRI	Fitting Colour	IK Rating
S9347WW	240V	4W	160lm	3000K	>80	Stainless Steel	10
S9347CW	240V	4W	160lm	4000K	>80	Stainless Steel	10

LED TWO WAY INGROUND LIGHT

S9348, S9349 PATHWAY

CONSTRUCTION

- Die-cast aluminium body
- 316 stainless steel face cover
- Opal polycarbonate diffuser
- High efficiency SMD LED chips
- Constant current LED driver fitted
- Moulding shaped silicone gasket
- IP68 PG9 PVC cable gland
- Stainless steel allen screws
- Installation PVC canister included

APPLICATIONS

- Walkways
- Stairwells
- Plazas

LOADING PRESSURE CAPACITY

- >2000KGS

IP RATING

- IP67 weatherproof

DIMENSIONS

S9348
Ø 116 mm



Ø 74 mm

Ø 102 mm

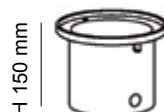

H 150 mm



S9348

S9349

Ø 173 mm



Ø 119 mm

Ø 157 mm



H 150 mm



S9349

Model No.	Input	Power	Lumen	CCT	CRI	Fitting Colour	IK Rating
S9348WW	240V	4W	80lm	3000K	>80	Stainless Steel	10
S9348CW	240V	4W	80lm	4000K	>80	Stainless Steel	10

Model No.	Input	Power	Lumen	CCT	CRI	Fitting Colour	IK Rating
S9349WW	240V	4W	80lm	3000K	>80	Stainless Steel	10
S9349CW	240V	4W	80lm	4000K	>80	Stainless Steel	10

LED ONE WAY INGROUND LIGHT

S9351, S9352 PATHWAY

CONSTRUCTION

- Die-cast aluminium body
- 316 stainless steel face cover
- Opal polycarbonate diffuser
- High efficiency SMD LED chips
- Constant current LED driver fitted
- Moulding shaped silicone gasket
- IP68 PG9 PVC cable gland
- Stainless steel allen screws
- Installation PVC canister included

APPLICATIONS

- Walkways
- Stairwells
- Plazas

LOADING PRESSURE CAPACITY

- >2000KGS

IP RATING

- IP67 weatherproof

DIMENSIONS

S9351

Ø 116 mm



Ø 74 mm
Ø 102 mm

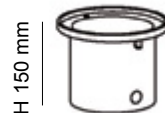

S9352

Ø 173 mm



Ø 119 mm
Ø 157 mm



S9351



S9352

Model No.	Input	Power	Lumen	CCT	CRI	Fitting Colour	IK Rating
S9351WW	240V	4W	40lm	3000K	>80	Stainless Steel	10
S9351CW	240V	4W	40lm	4000K	>80	Stainless Steel	10

Model No.	Input	Power	Lumen	CCT	CRI	Fitting Colour	IK Rating
S9352WW	240V	4W	40lm	3000K	>80	Stainless Steel	10
S9352CW	240V	4W	40lm	4000K	>80	Stainless Steel	10

LED SPOT LIGHT

S9353, S9354 TORCH

CONSTRUCTION

- Die-cast aluminium body
- Powder coated finish
- Tempered glass diffuser
- High efficiency COB LED chip
- High performance multi-reflector system
- Constant current LED driver fitted
- IP66 PVC cable gland
- Stainless steel allen screws

APPLICATIONS

- Parks
- Gardens

IP RATING

- IP65 weatherproof

DIMENSIONS

S9353

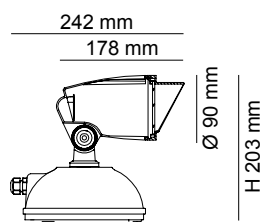

L x W 170 x 115 mm

S9354

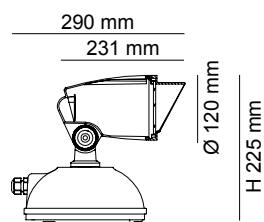

L x W 170 x 115 mm



S9353



S9354

Model No.	Input	Power	Lumen	CCT	CRI	Beam Angle	Fitting Colour
S9353WW/BK	240V	16W	1200lm	3000K	>80	25°	Black
S9353CW/BK	240V	16W	1200lm	4000K	>80	25°	Black
S9353WW/CB	240V	16W	1200lm	3000K	>80	25°	Charcoal Black
S9353CW/CB	240V	16W	1200lm	4000K	>80	25°	Charcoal Black

Model No.	Input	Power	Lumen	CCT	CRI	Beam Angle	Fitting Colour
S9354WW/BK	240V	22W	1500lm	3000K	>80	25°	Black
S9354CW/BK	240V	22W	1500lm	4000K	>80	25°	Black
S9354WW/CB	240V	22W	1500lm	3000K	>80	25°	Charcoal Black
S9354CW/CB	240V	22W	1500lm	4000K	>80	25°	Charcoal Black



LED FLOOD LIGHTS

SE7079 DECOSTAR

CONSTRUCTION

- Die-cast aluminium body
- Powder coated finish
- Moulding shaped silicon gasket
- Tempered glass diffuser
- High efficiency COB LED chip
- Constant current LED driver fitted
- IP65 nickel plated copper cable gland

APPLICATIONS

- Shops
- Warehouses
- Parks
- Car Parks

IP RATING

- IP65 weatherproof



DIMENSIONS

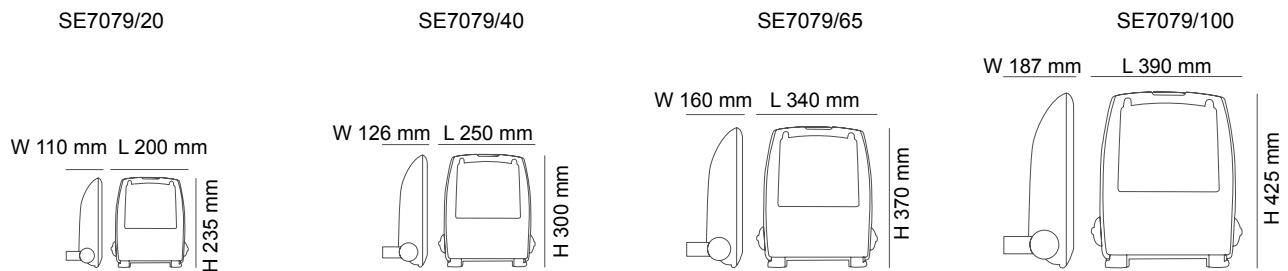

Model No.	Input	Power	Lumen	CCT	CRI	Beam Angle	Fitting Colour
SE7079/20 BK DL	240V	20W	1200lm	5500K	>80	90°	Black
SE7079/40 BK WW	240V	40W	2100lm	3000K	>80	90°	Black
SE7079/40 BK DL	240V	40W	2400lm	5500K	>80	90°	Black
SE7079/65 BK WW	240V	65W	3400lm	3000K	>80	90°	Black
SE7079/65 BK DL	240V	65W	3800lm	5500K	>80	90°	Black
SE7079/100 BK WW	240V	105W	6000lm	3000K	>80	90°	Black
SE7079/100 BK DL	240V	105W	6500lm	5500K	>80	90°	Black

PHOTOMETRIC DATA

Unit: cd SE7079/20 DL
C0/C180 — C90/C270

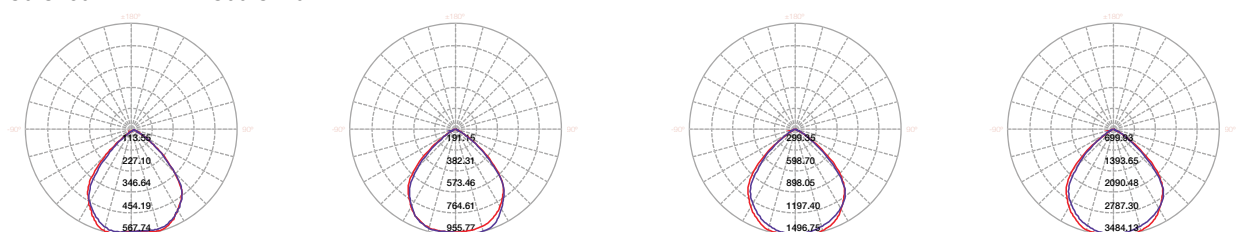

LED FLOOD LIGHTS

SE7099 MAXISTAR



CONSTRUCTION

- Premium grade aluminium body
- Powder coated finish
- Frosted glass diffuser
- High efficiency SMD LED chips
- Constant current LED driver fitted
- 1.5m rubber flex

APPLICATIONS

- Shops
- Warehouses
- Parks
- Car Parks

IP RATING

- IP66 weatherproof

DIMENSIONS

SE7099/50

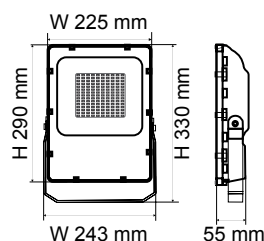

SE7099/75

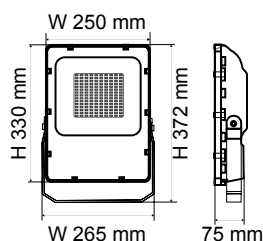

SE7099/150

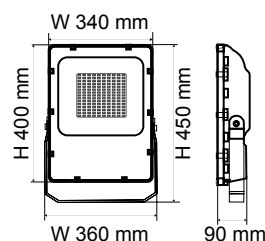

SE7099/200

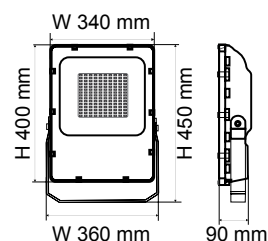

Model No.	Input	Power	Lumen	CCT	CRI	Dimmable	Beam Angle	Fitting Colour
SE7099/50WW/BK	240V	50W	4500lm	3000K	>80	No	120°	Black
SE7099/50WW/SL	240V	50W	4500lm	3000K	>80	No	120°	Silver
SE7099/50DL/BK	240V	50W	5000lm	5700K	>80	No	120°	Black
SE7099/50DL/SL	240V	50W	5000lm	5700K	>80	No	120°	Silver

Model No.	Input	Power	Lumen	CCT	CRI	Dimmable	Beam Angle	Fitting Colour
SE7099/75WW/BK	240V	75W	6500lm	3000K	>80	No	120°	Black
SE7099/75WW/SL	240V	75W	6500lm	3000K	>80	No	120°	Silver
SE7099/75DL/BK	240V	75W	7500lm	5700K	>80	No	120°	Black
SE7099/75DL/SL	240V	75W	7500lm	5700K	>80	No	120°	Silver



LED FLOOD LIGHTS

Model No.	Input	Power	Lumen	CCT	CRI	Dimmable	Beam Angle	Fitting Colour
SE7099/150WW/BK	240V	150W	13000lm	3000K	>80	No	120°	Black
SE7099/150WW/SL	240V	150W	13000lm	3000K	>80	No	120°	Silver
SE7099/150DL/BK	240V	150W	15000lm	5700K	>80	No	120°	Black
SE7099/150DL/SL	240V	150W	15000lm	5700K	>80	No	120°	Silver

Model No.	Input	Power	Lumen	CCT	CRI	Dimmable	Beam Angle	Fitting Colour
SE7099/200WW/BK	240V	200W	20000lm	3000K	>80	No	120°	Black
SE7099/200WW/SL	240V	200W	20000lm	3000K	>80	No	120°	Silver
SE7099/200DL/BK	240V	200W	22000lm	5700K	>80	No	120°	Black
SE7099/200DL/SL	240V	200W	22000lm	5700K	>80	No	120°	Silver

PHOTOMETRIC DATA

Unit: cd C0/C180 — C90/C270

SE7099/50DL

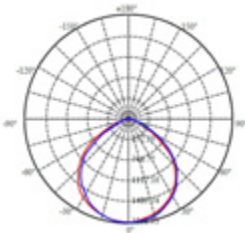

SE7099/50WW

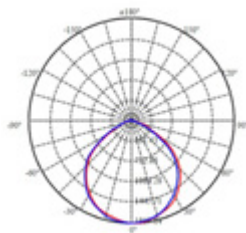

SE7099/75DL

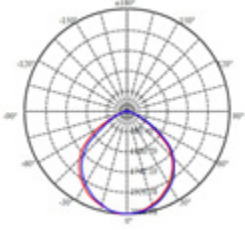

SE7099/75WW

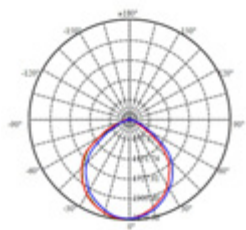

SE7099/150DL

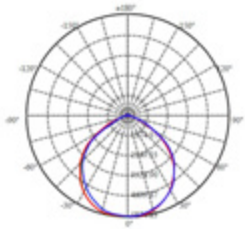

SE7099/150WW

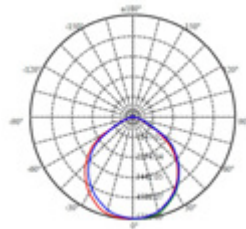

SE7099/200DL

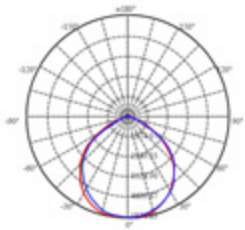

SE7099/200WW

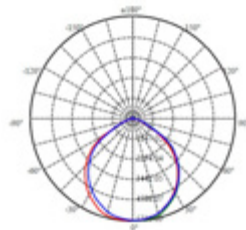

ACCESSORY OPTIONS

SPIKE
SE7099SPK/BK

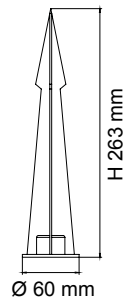

POLE MOUNTING BRACKET (for SE7099/50 & SE7099/75 only)
SE7099PMB/BK

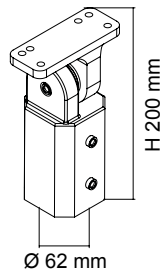

ARM MOUNTING BRACKET
SE7099AMB/BK5 L 500 mm
SE7099AMB/BK8 L 800 mm
SE7099AMB/BK10 L 1000 mm

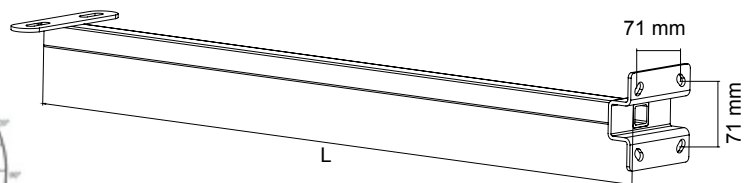

LED HIGH BAY

SHB14/120, SHB14/120MD, SHB14/120PD MINI SATELLITE



CONSTRUCTION

- Die-cast aluminium body
- Powder coated finish
- Compact design, light weight
- High efficiency SMD LED chips module
- Standard beam angle 110°
- Constant current LED driver fitted
- IP67 PVC cable gland
- 1.5 m flex & 3 pin plug fitted

APPLICATIONS

- Workshops
- Warehouse
- Industrial

DIMMING OPTIONS

- 1-10V dimming on order

BEAM ANGLE OPTIONS

- 70° beam angle (aluminium reflector)

IP RATING

- IP65 weatherproof

DIMENSIONS

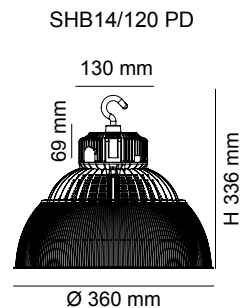
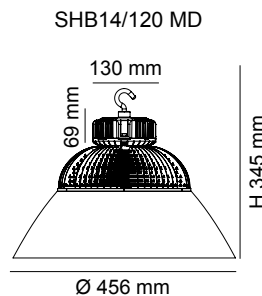
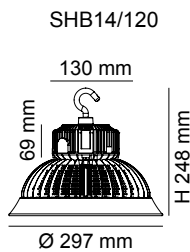

Model No.	Input	Power	Lumen	CCT	CRI	Beam Angle	Temperature	Weight	Fitting Colour	Reflector
SHB14/120	240V	110W	12000lm	6000K	>75	110°	-30~+50°C	2.6kg	Black	-
SHB14/120 MD	240V	110W	12000lm	6000K	>75	110°	-30~+50°C	3.6kg	Black	Aluminium
SHB14/120 PD	240V	110W	12000lm	6000K	>75	110°	-30~+50°C	3.6kg	Black	Polycarbonate

PHOTOMETRIC DATA

Unit: cd C0/C180 ———— C90/C270 ————

SHB14/120

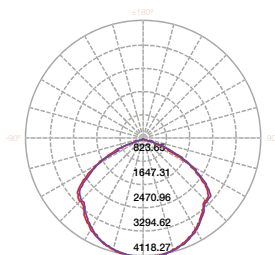

www.sal.net.au

LED HIGH BAY

SHB14/200, SHB14/200 MD, SHB14/300, SHB14/300 MD MAXI SATELLITE

CONSTRUCTION

- Die-cast aluminium body
- Powder coated finish
- Compact design, light weight
- High efficiency SMD LED chips module
- Standard beam angle 110°
- Constant current LED driver
- IP66 PVC cable gland
- 1.5 m flex & 3 pin plug fitted

APPLICATIONS

- Workshops
- Warehouse
- Industrial

DIMMING OPTIONS

- 1-10V dimmable on order

BEAM ANGLE OPTIONS

- 70° beam angle (aluminium reflector)

IP RATING

- IP65 weatherproof



SHB14/200, SHB14/300



SHB14/200 MD, SHB14/300 MD

DIMENSIONS

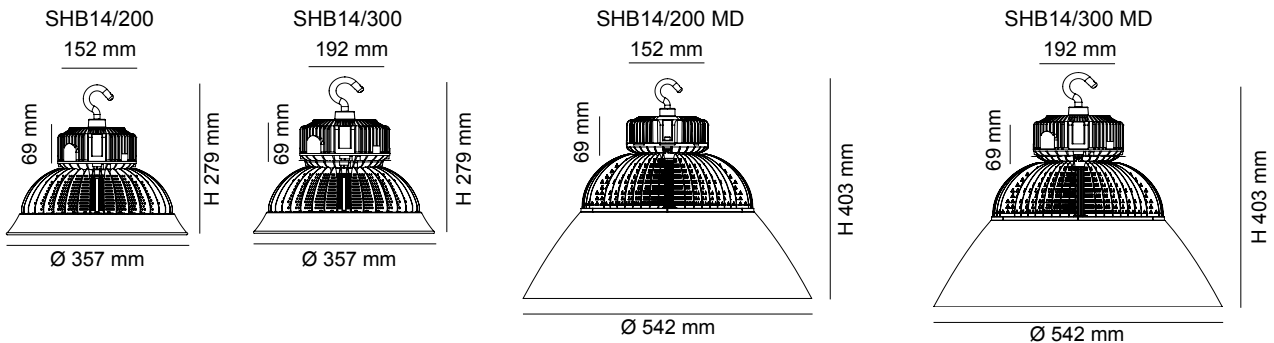

Model No.	Input	Power	Lumen	CCT	CRI	Beam Angle	Temperature	Weight	Fitting Colour	Reflector
SHB14/200	240V	180W	22000lm	6000K	>75	110°	-30~+50°C	5.2kg	Black	-
SHB14/200 MD	240V	180W	22000lm	6000K	>75	110°	-30~+50°C	6.2kg	Black	Aluminium
SHB14/300	240V	240W	28000lm	6000K	>75	110°	-30~+50°C	6.2kg	Black	-
SHB14/300 MD	240V	240W	28000lm	6000K	>75	110°	-30~+50°C	7.2kg	Black	Aluminium

PHOTOMETRIC DATA

Unit: cd C0/C180 — C90/C270 —

SHB14/200

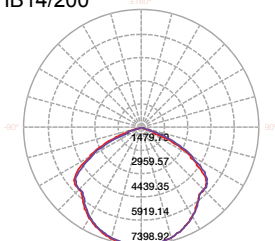

LED HIGH BAY

SHB22/140, SHB22/240 EAGLE

CONSTRUCTION

- Die-cast aluminium body
- Powder coated finish
- High efficiency SMD LED chips
- Standard beam angle 80°
- Constant current LED driver
- IP66 PVC cable gland
- 1.0 m flex & 3 pin plug fitted

DIMMING OPTIONS

- 1-10V dimming on order

IP RATING

- IP65 weatherproof

DIMENSIONS

SHB22/140

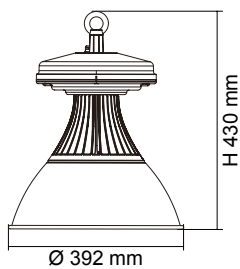

SHB22/240

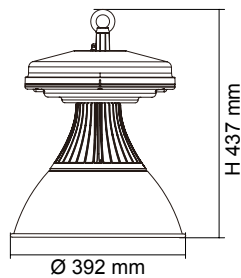

Model No.	Input	Power	Lumen	CCT	CRI	Beam Angle	Weight	Colour	Temperature
SHB22/140	240V	140W	14000lm	5000K	>75	80°	5.8kg	Black	-20~50°C

Model No.	Input	Power	Lumen	CCT	CRI	Beam Angle	Weight	Colour	Temperature
SHB22/240	240V	240W	26000lm	5000K	>75	80°	6.6kg	Black	-20~50°C

PHOTOMETRIC DATA

Unit: cd SHB22/140DL C0/C180 —
 C90/C270 —

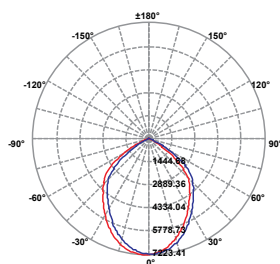

SHB22/240DL

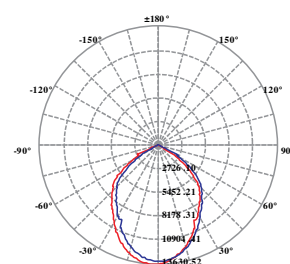

LED AREA LIGHTS

SHP100/60, SHP100/90, SHP100/120 SPARK

CONSTRUCTION

- Die-cast aluminium body
- Powder coated finish
- IP66 30W high output LED module
- IP67 high power factor LED driver fitted
- IP66 quick connector system
- Pole mounting angle adjustable from 0° to 90°

APPLICATIONS

- Streets
- Parks
- Car Parks
- Driveways
- Pathways

IP RATING

- IP66 weatherproof

DIMENSIONS

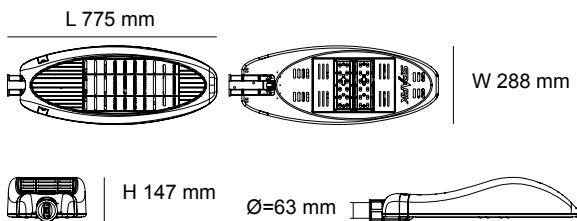

Model No.	Input	Power	Lumen	CCT	CRI	Fitting Colour	Temperature
SHP100/60 BK	240V	60W	5100lm	6000K	>75	Black	-30~+50°C
SHP100/60 CB	240V	60W	5100lm	6000K	>75	Charcoal Black	-30~+50°C

Model No.	Input	Power	Lumen	CCT	CRI	Fitting Colour	Temperature
SHP100/90 BK	240V	90W	7650lm	6000K	>75	Black	-30~+50°C
SHP100/90 CB	240V	90W	7650lm	6000K	>75	Charcoal Black	-30~+50°C

Model No.	Input	Power	Lumen	CCT	CRI	Fitting Colour	Temperature
SHP100/120 BK	240V	120W	10200lm	6000K	>75	Black	-30~+50°C
SHP100/120 CB	240V	120W	10200lm	6000K	>75	Charcoal Black	-30~+50°C

PHOTOMETRIC DATA

Unit: cd

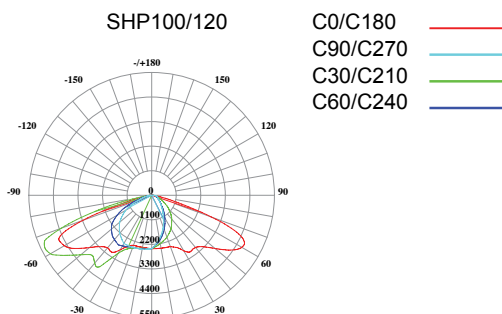

Specifications above are for reference only and may vary without prior notice

LED POST LIGHT

SE7103, SE7104, SE7105, SE7106 BOLLARD

CONSTRUCTION

- Die-cast aluminium body
- Powder coated finish
- E27 lamp base
- LED lamp not included

APPLICATIONS

- Parks
- Walkways

IP RATING

- IP54 weatherproof

DIMENSIONS

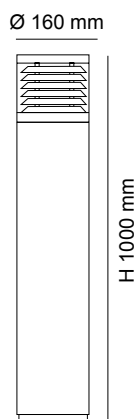

- Opal acrylic diffuser

Model No.	Input	Power	Lumen	CCT	CRI	Beam Angle	Light Source	Colour
SE7103BK/LGLS	240V						Refer to the Lamp, Drivers & Accessories Section of this catalogue	Black
SE7104BK/LGLS	240V					Black		

- Clear acrylic diffuser
- Matt aluminium reflector

Model No.	Input	Power	Lumen	CCT	CRI	Beam Angle	Light Source	Colour
SE7105BK/LGLS	240V						Refer to the Lamp, Drivers & Accessories Section of this catalogue	Black
SE7106BK/LGLS	240V					Black		

LED POST LIGHT

SLA7102, SE7102/LGLS BOLLARD

CONSTRUCTION

- Die-cast aluminium body
- Powder coated finish
- Clear polycarbonate diffuser

SLA7102 BOLLARD

- Matt aluminium reflector
- High efficiency SMD LED chips
- Constant current LED driver fitted

SE7102/LGLS BOLLARD

- Stainless steel reflector
- E27 lamp base
- LED lamp NOT included

APPLICATIONS

- Parks
- Walkways

IP RATING

- IP54 weatherproof

DIMENSIONS

SLA7102

SE7102/LGLS

Ø 203 mm

Ø 203 mm

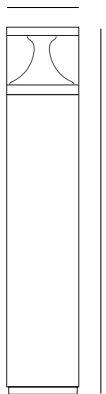

H 1000 mm

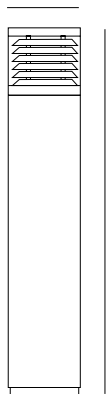

H 1000 mm

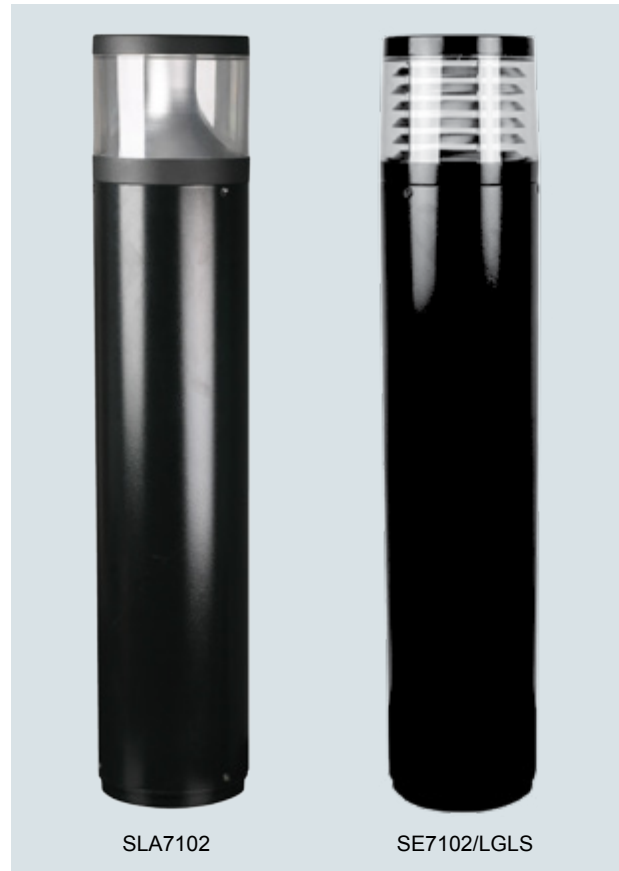

SLA7102

SE7102/LGLS

PHOTOMETRIC DATA

Unit: cd

SLA7102

C0/C180

C90/C270

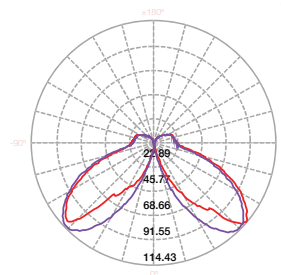

Model No.	Input	Power	Lumen	CCT	CRI	Colour
SLA7102BK	240V	18W	1200lm	6000K	>75	Black
SLA7102SL	240V	18W	1200lm	6000K	>75	Silver

Model No.	Input	Power	Lumen	CCT	CRI	Beam Angle	Colour
SE7102 BK/LGLS	Refer to the Lamp, Drivers & Accessories Section of this catalogue						Black
SE7102 SL/LGLS	Refer to the Lamp, Drivers & Accessories Section of this catalogue						Silver



LAMPS, DRIVERS & ACCESSORIES



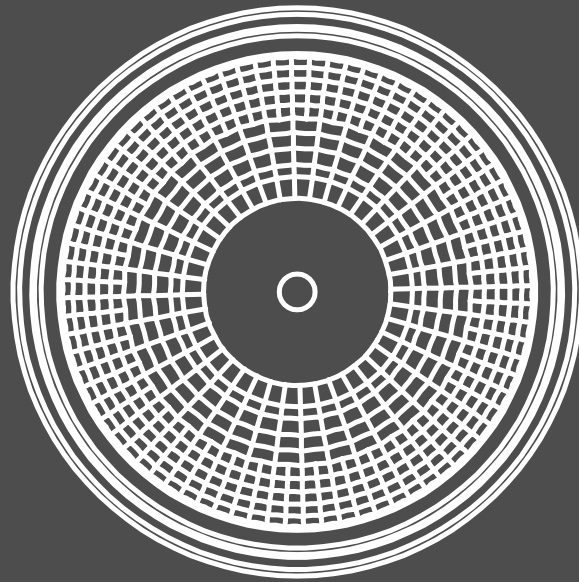

MR16 LED LAMP	241	PLUTO, DIM DIMMABLE CONSTANT CURRENT LED DRIVERS	264
GU10 LED LAMP	242	MINI ELECTRONIC TRANSFORMERS	265
G4L LED LAMP	243	ST105, ST150, ST200, ST300, ST400	266
G9 LED LAMP	243	SELK2500/SM TRIANGLE LED EMERGENCY KIT	266
GX53 LED LAMP	244	SELK1500/SF S-FIRE	267
LT407, LT409 TUBULAR LAMPS	245	SDD350TCM, SDD350TCS TRAILING EDGE DIMMER	268
LR50, LR63, LR80, LR95 LED R LAMPS	246	SDA450	268
LPAR20, LPAR30, LPAR38 LED PAR LAMPS	247	SDF30	268
LG95, LG125 LED SPHERICAL LAMPS	248	ESS101 QUICK CONNECT SURFACE SOCKET	269
LG3, LG5, LG7, LG9 GLS LED LAMPS	249	ESS102 SURFACE SOCKET	269
LGS4, LGS8, LGS10 ECO SERIES	250	2S9000	270
LGS11D ECO SERIES DIMMABLE LAMP	251	3S9000	270
LCA35 CANDLE LED LAMP	252	SGU9000LH	270
LFR35 FANCY ROUND LED LAMP	253	CONVERTER M/LV	270
LT25 FILAMENT TUBULAR LED LAMP	254	SLH100	270
LCAF FILAMENT CANDLE LED LAMP	255	S9901, S9903	270
LGF6 DIMMABLE FILAMENT GLS LED LAMP	256	S9922	270
LG125F FILAMENT SPHERICAL LED LAMP	257	SSI1512, SSY1512	271
LST21FD, LG125FD FILAMENT DECO LED LAMPS	258	S9913	271
LT8/60, LT8/120 T8 LED TUBE	259	SMS800 SENSOR	272
AR111 LED LAMP	260	SMS810 SENSOR	273
AR111 LED MODULES	260	SMS801WF SENSOR	274
SLC21, SLC30 CONVERSION KITS	261	SMS802WR SENSOR	275
PLUTO, PLUTO EGL CONSTANT VOLTAGE LED DRIVER	262	SMS803CD SENSOR	276
DIM40W/12V DIMMABLE CONSTANT VOLTAGE DRIVER	263	SMS804CR SENSOR	277
		SMS805CS SENSOR	278

12V GU5.3 LED LAMP

MR16 LED LAMP

CONSTRUCTION

- Poly covered aluminium housing
- Shockproof frosted polycarbonate lens
- High efficiency LED chips
- Directly replace MR16 halogen lamp
- 12V AC or DC driver required
- AcTEC & leading brand electronic transformer compatible
- Suits most halogen MR16 fittings

COLOUR TEMPERATURE

- 3000K WARM WHITE
- 6000K DAYLIGHT

DIMENSIONS

MR16 5W

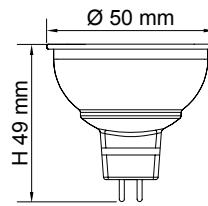

MR16/7W

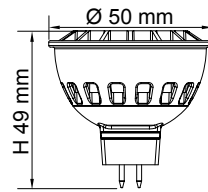

MR16DIM9W

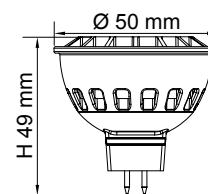

Model No.	Input	Power	Lumen	Beam Angle	CCT	CRI	Dimmable	Lamp Base
MR16 5W WW	12V AC or DC	5W	330lm	38°	3000K	>80	No	GU5.3
MR16 5W DL	12V AC or DC	5W	350lm	38°	6000K	>80	No	GU5.3

Model No.	Input	Power	Lumen	Beam Angle	CCT	CRI	Dimmable	Lamp Base
MR16/7W/WW	12V AC or DC	7W	500lm	60°	3000K	>80	No	GU5.3
MR16/7W/DL	12V AC or DC	7W	550lm	60°	6000K	>80	No	GU5.3

Model No.	Input	Power	Lumen	Beam Angle	CCT	CRI	Dimmable	Lamp Base
MR16DIM9W/WW	12V AC or DC	9W	500lm	60°	3000K	>80	Yes	GU5.3
MR16DIM9W/DL	12V AC or DC	9W	550lm	60°	6000K	>80	Yes	GU5.3



240V GU10 LED LAMP

GU10 LED LAMP

CONSTRUCTION

- Poly covered aluminium housing
- Shockproof frosted polycarbonate lens
- High efficiency LED chips
- Built-in LED driver
- Suits most halogen GU10 fittings

COLOUR TEMPERATURE

- 3000K WARM WHITE
- 6000K DAYLIGHT

DIMENSIONS

GU10L350, GU10L550

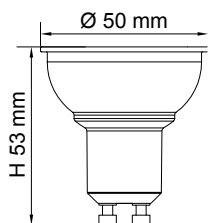

GU10LR750, GU10LA750

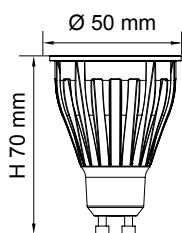

Model No.	Input	Power	Lumen	Beam Angle	CCT	CRI	Dimmable	Lamp Base
GU10L350WW	240V	4W	300lm	38°	3000K	>80	No	GU10
GU10L350DL	240V	4W	350lm	38°	6000K	>80	No	GU10

Model No.	Input	Power	Lumen	Beam Angle	CCT	CRI	Dimmable	Lamp Base
GU10L550WW	240V	6W	500lm	50°	3000K	>80	No	GU10
GU10L550DL	240V	6W	550lm	50°	6000K	>80	No	GU10

Model No.	Input	Power	Lumen	Beam Angle	CCT	CRI	Dimmable	Lamp Base
GU10LR750WW	240V	9W	700lm	60°	3000K	>80	No	GU10
GU10LR750DL	240V	9W	750lm	60°	6000K	>80	No	GU10

Model No.	Input	Power	Lumen	Beam Angle	CCT	CRI	Dimmable	Lamp Base
GU10LA750WW	240V	9W	700lm	60°	3000K	>80	Yes	GU10
GU10LA750DL	240V	9W	750lm	60°	6000K	>80	Yes	GU10

12V G4 LED LAMPS

G4L LED LAMP

CONSTRUCTION

- Transparent silicone body
- High efficiency LED chips
- Wide beam angle 270°
- 12V AC or DC driver required
- Compatible with leading brand electronic transformers
- Suits most G4 lamp fittings

COLOUR TEMPERATURE

- 3000K WARM WHITE
- 6000K DAYLIGHT

LAMP BASE

- G4

DIMENSIONS

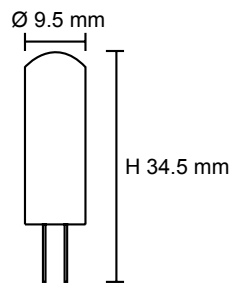

G4L15

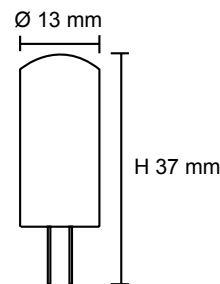

G4L25

Model No.	Input	Power	Lumen	Beam Angle	CCT	CRI	Dimmable	Lamp Base
G4L15WW	12V AC or DC	1.5W	90lm	270°	3000K	>80	No	G4
G4L15DL	12V AC or DC	1.5W	100lm	270°	6000K	>80	No	G4

Model No.	Input	Power	Lumen	Beam Angle	CCT	CRI	Dimmable	Lamp Base
G4L25WW	12V AC or DC	2.5W	160lm	270°	3000K	>80	No	G4
G4L25DL	12V AC or DC	2.5W	180lm	270°	6000K	>80	No	G4

240V G9 LED LAMP

G9 LED LAMP

CONSTRUCTION

- Opal polycarbonate body
- High efficiency SMD LED chips
- Wide beam angle 360°
- Built-in trailing edge dimmable LED driver
- Suits most G9 lamp fittings

COLOUR TEMPERATURE

- 3000K WARM WHITE
- 6000K DAYLIGHT

LAMP BASE

- G9

DIMENSIONS

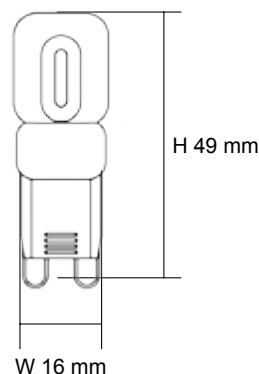

Model No.	Input	Power	Lumen	Beam Angle	CCT	CRI	Dimmable	Lamp Base
G9L3D/ WW	240V	2.5W	200lm	360°	3000K	>80	Yes*	G9
G9L3D/ DL	240V	2.5W	220lm	360°	6000K	>80	Yes*	G9

*Trailing edge analogue dimming

240V GX53 LED LAMP

GX53 LED LAMP

CONSTRUCTION

- Plastic body
- Frosted glass diffuser
- High efficiency SMD LED chips
- Built-in LED driver
- Suits most GX53 lamp fittings

COLOUR TEMPERATURE

- 3000K WARM WHITE
- 4000K COOL WHITE
- 6000K DAYLIGHT

LAMP BASE

- GX53

DIMENSIONS

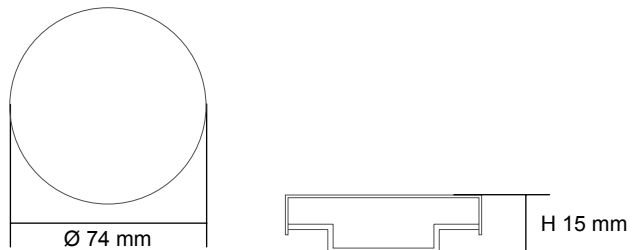

Model No.	Input	Power	Lumen	Beam Angle	CCT	CRI	Dimmable	Lamp Base
GX53/450 WW	240V	5W	420lm	120°	3000K	>80	No	GX53
GX53/450 CW	240V	5W	430lm	120°	4000K	>80	No	GX53
GX53/450 DL	240V	5W	450lm	120°	6000K	>80	No	GX53

240V LED TUBULAR LAMP

LT407, LT409 TUBULAR LAMPS

CONSTRUCTION

- Poly covered aluminium body
- Opal polycarbonate diffuser
- High efficiency SMD LED chips
- 270° wide beam angle
- Built-in LED driver
- Suits most CFL lamp fittings
- Non-dimmable

COLOUR TEMPERATURE

- 3000K WARM WHITE
- 4000K COOL WHITE
- 6000K DAYLIGHT

LAMP BASE

- E27, B22

DIMENSIONS

LT407/E27

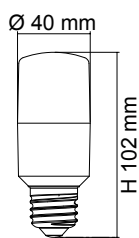

LT409/E27

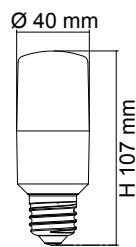

LT407/B22

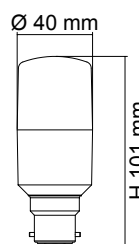

LT409/B22

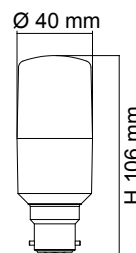

LT407/E27

LT409/E27



LT407/B22

LT409/B22

Model No.	Input	Power	Lumen	CCT	CRI	Dimmable	Beam Angle	Lamp Base
LT407/27E27	240V	7W	650lm	3000K	>80	No	270°	E27
LT407/40E27	240V	7W	700lm	4000K	>80	No	270°	E27
LT407/65E27	240V	7W	750lm	6000K	>80	No	270°	E27
LT407/27B22	240V	7W	650lm	3000K	>80	No	270°	B22
LT407/40B22	240V	7W	700lm	4000K	>80	No	270°	B22
LT407/65B22	240V	7W	750lm	6000K	>80	No	270°	B22

Model No.	Input	Power	Lumen	CCT	CRI	Dimmable	Beam Angle	Lamp Base
LT409/27E27	240V	9W	850lm	3000K	>80	No	270°	E27
LT409/40E27	240V	9W	900lm	4000K	>80	No	270°	E27
LT409/65E27	240V	9W	950lm	6000K	>80	No	270°	E27
LT409/27B22	240V	9W	850lm	3000K	>80	No	270°	B22
LT409/40B22	240V	9W	900lm	4000K	>80	No	270°	B22
LT409/65B22	240V	9W	950lm	6000K	>80	No	270°	B22



240V LED R LAMP

LR50, LR63, LR80, LR95 LED R LAMPS



CONSTRUCTION

- 1:1 size to traditional R lamp
- Poly covered aluminium body
- Opal polycarbonate diffuser
- High efficiency SMD LED chips
- Built-in LED driver
- Suits most R lamp fittings

COLOUR TEMPERATURE

- 3000K WARM WHITE
- 6000K DAYLIGHT

LAMP BASE

- E27
- E14

DIMENSIONS

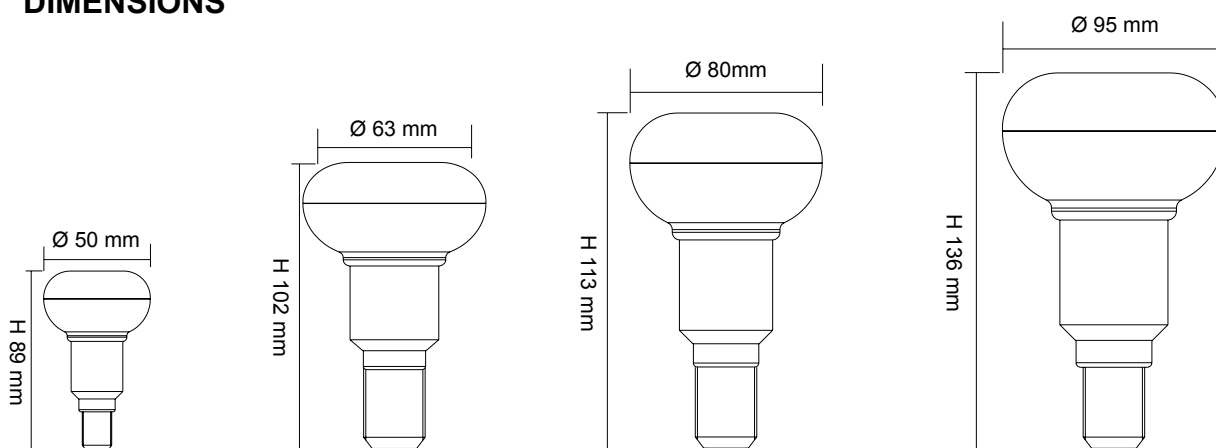

Model No.	Input	Power	Lumen	Beam Angle	CCT	CRI	Dimmable	Lamp Base
LR50WW	240V	7W	650lm	120°	3000K	>80	No	E14
LR50DL	240V	7W	650lm	120°	6000K	>80	No	E14
Model No.	Input	Power	Lumen	Beam Angle	CCT	CRI	Dimmable	Lamp Base
LR63WW	240V	7W	650lm	120°	3000K	>80	No	E27
LR63DL	240V	7W	650lm	120°	6000K	>80	No	E27
Model No.	Input	Power	Lumen	Beam Angle	CCT	CRI	Dimmable	Lamp Base
LR80WW	240V	9W	850lm	120°	3000K	>80	No	E27
LR80DL	240V	9W	850lm	120°	6000K	>80	No	E27
Model No.	Input	Power	Lumen	Beam Angle	CCT	CRI	Dimmable	Lamp Base
LR95WW	240V	9W	850lm	120°	3000K	>80	No	E27
LR95DL	240V	9W	850lm	120°	6000K	>80	No	E27

240V LED PAR LAMP

LPAR20, LPAR30, LPAR38 LED PAR LAMPS



CONSTRUCTION

- 1:1 size to traditional PAR lamp
- Poly covered aluminium body
- Opal polycarbonate diffuser
- High efficiency SMD LED chips
- Built-in LED driver
- Suits most PAR lamp fittings

COLOUR TEMPERATURE

- 3000K WARM WHITE
- 6000K DAYLIGHT

LAMP BASE

- E27

DIMENSIONS

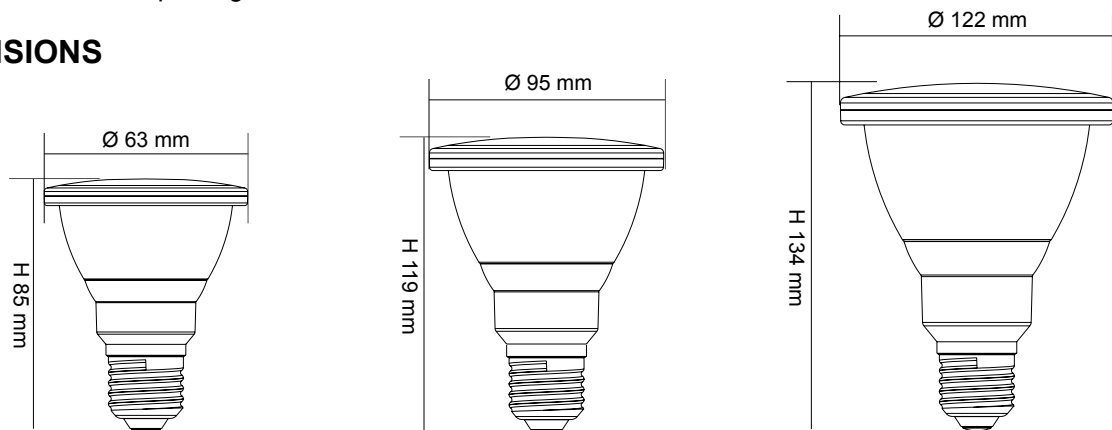

Model No.	Input	Power	Lumen	Beam Angle	CCT	CRI	Dimmable	Lamp Base
LPAR20WW	240V	7W	600lm	100°	3000K	>80	No	E27
LPAR20DL	240V	7W	600lm	100°	6000K	>80	No	E27

Model No.	Input	Power	Lumen	Beam Angle	CCT	CRI	Dimmable	Lamp Base
LPAR30WW	240V	9W	800lm	100°	3000K	>80	No	E27
LPAR30DL	240V	9W	800lm	100°	6000K	>80	No	E27

Model No.	Input	Power	Lumen	Beam Angle	CCT	CRI	Dimmable	Lamp Base
LPAR38WW	240V	12W	1050lm	100°	3000K	>80	No	E27
LPAR38DL	240V	12W	1050lm	100°	6000K	>80	No	E27

240V G95 & G125 LED LAMP

LG95, LG125 LED SPHERICAL LAMPS



CONSTRUCTION

- 1:1 size to traditional spherical lamp
- Safe plastic shell
- Opal polycarbonate diffuser
- High efficiency SMD LED chips
- Built-in dimmable LED driver
- Dimmable with trailing edge dimmer
- Suits most spherical lamp fittings

COLOUR TEMPERATURE

- 3000K WARM WHITE
- 6000K DAYLIGHT

LAMP BASE

- E27
- B22

DIMENSIONS

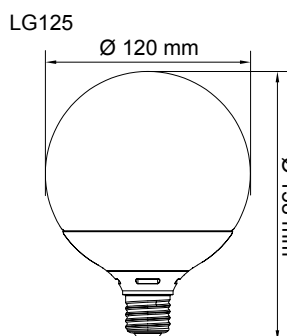
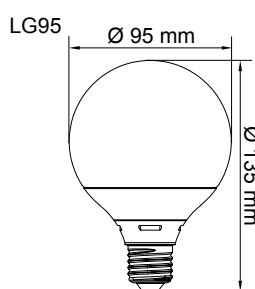

Model No.	Input	Power	Lumen	Beam Angle	CCT	CRI	Dimmable	Lamp Base
LG95/830B22	240V	10W	900lm	270°	3000K	>80	Yes	B22
LG95/860B22	240V	10W	950lm	270°	6000K	>80	Yes	B22
LG95/830E27	240V	10W	900lm	270°	3000K	>80	Yes	E27
LG95/860E27	240V	10W	950lm	270°	6000K	>80	Yes	E27

Model No.	Input	Power	Lumen	Beam Angle	CCT	CRI	Dimmable	Lamp Base
LG125/830B22	240V	13W	1100lm	270°	3000K	>80	Yes	B22
LG125/860B22	240V	13W	1200lm	270°	6000K	>80	Yes	B22
LG125/830E27	240V	13W	1100lm	270°	3000K	>80	Yes	E27
LG125/860E27	240V	13W	1200lm	270°	6000K	>80	Yes	E27

240V GLS LED LAMP

LG3, LG5, LG7, LG9 GLS LED LAMPS

CONSTRUCTION

- 1:1 size to traditional GLS lamp
- Ceramic body
- Opal glass diffuser
- High efficiency SMD LED chips
- Wide beam angle
- Built-in LED driver
- Double insulation
- Suits most GLS lamp fittings

COLOUR TEMPERATURE

- 3000K WARM WHITE
- 6000K DAYLIGHT

DIMENSIONS

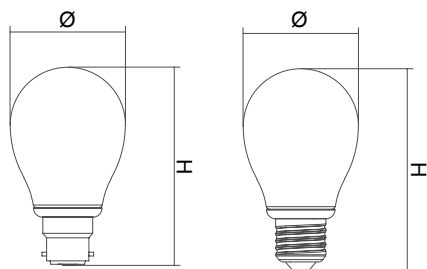

LAMP BASES

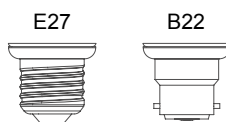

Model No.	Input	Power	Lumen	Beam Angle	CCT	CRI	Dimmable	Dimensions Ø x H	Lamp Base
LG3/830B22	240V	3W	250lm	330°	3000K	>80	No	60 x 103 mm	B22
LG3/860B22	240V	3W	300lm	330°	6000K	>80	No	60 x 103 mm	B22
LG3/830E27	240V	3W	250lm	330°	3000K	>80	No	60 x 105 mm	E27
LG3/860E27	240V	3W	300lm	330°	6000K	>80	No	60 x 105 mm	E27

Model No.	Input	Power	Lumen	Beam Angle	CCT	CRI	Dimmable	Dimensions Ø x H	Lamp Base
LG5/830B22	240V	5W	400lm	330°	3000K	>80	No	60 x 103 mm	B22
LG5/860B22	240V	5W	450lm	330°	6000K	>80	No	60 x 103 mm	B22
LG5/830E27	240V	5W	400lm	330°	3000K	>80	No	60 x 105 mm	E27
LG5/860E27	240V	5W	450lm	330°	6000K	>80	No	60 x 105 mm	E27

Model No.	Input	Power	Lumen	Beam Angle	CCT	CRI	Dimmable	Dimensions Ø x H	Lamp Base
LG7/830B22	240V	7W	600lm	330°	3000K	>80	No	60 x 112 mm	B22
LG7/860B22	240V	7W	650lm	330°	6000K	>80	No	60 x 112 mm	B22
LG7/830E27	240V	7W	600lm	330°	3000K	>80	No	60 x 112 mm	E27
LG7/860E27	240V	7W	650lm	330°	6000K	>80	No	60 x 112 mm	E27

Model No.	Input	Power	Lumen	Beam Angle	CCT	CRI	Dimmable	Dimensions Ø x H	Lamp Base
LG9/830B22	240V	9W	750lm	330°	3000K	>80	No	60 x 117 mm	B22
LG9/860B22	240V	9W	800lm	330°	6000K	>80	No	60 x 117 mm	B22
LG9/830E27	240V	9W	750lm	330°	3000K	>80	No	60 x 117 mm	E27
LG9/860E27	240V	9W	800lm	330°	6000K	>80	No	60 x 117 mm	E27



240V GLS LED LAMP

LGS4, LGS8, LGS10 ECO SERIES

CONSTRUCTION

- 1:1 size to traditional GLS lamp
- Poly covered aluminium body
- Opal glass diffuser
- High efficiency SMD LED chips
- Wide beam angle
- Built-in LED driver
- Suits most GLS lamp fittings

COLOUR TEMPERATURE

- 2700K WARM WHITE
- 4000K COOL WHITE
- 6500K DAYLIGHT

DIMENSIONS

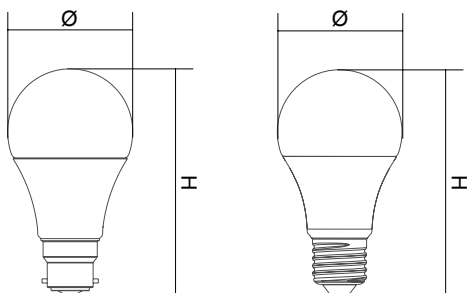

LAMP BASES

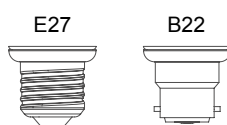

Model No.	Input	Power	Lumen	Beam Angle	CCT	CRI	Dimmable	Dimensions Ø x H	Lamp Base
LGS4/830B22	240V	4W	350lm	270°	2700K	>80	No	55 x 103 mm	B22
LGS4/840B22	240V	4W	400lm	270°	4000K	>80	No	55 x 103 mm	B22
LGS4/860B22	240V	4W	480lm	270°	6500K	>80	No	55 x 103 mm	B22
LGS4/830E27	240V	4W	350lm	270°	2700K	>80	No	55 x 103 mm	E27
LGS4/840E27	240V	4W	400lm	270°	4000K	>80	No	55 x 103 mm	E27
LGS4/860E27	240V	4W	480lm	270°	6500K	>80	No	55 x 103 mm	E27

Model No.	Input	Power	Lumen	Beam Angle	CCT	CRI	Dimmable	Dimensions Ø x H	Lamp Base
LGS8/830B22	240V	8W	700lm	270°	2700K	>80	No	55 x 103 mm	B22
LGS8/840B22	240V	8W	750lm	270°	4000K	>80	No	55 x 103 mm	B22
LGS8/860B22	240V	8W	800lm	270°	6500K	>80	No	55 x 103 mm	B22
LGS8/830E27	240V	8W	700lm	270°	2700K	>80	No	55 x 103 mm	E27
LGS8/840E27	240V	8W	750lm	270°	4000K	>80	No	55 x 103 mm	E27
LGS8/860E27	240V	8W	800lm	270°	6500K	>80	No	55 x 103 mm	E27

Model No.	Input	Power	Lumen	Beam Angle	CCT	CRI	Dimmable	Dimensions Ø x H	Lamp Base
LGS10/830B22	240V	10W	950lm	270°	2700K	>80	No	60 x 108 mm	B22
LGS10/840B22	240V	10W	1000lm	270°	4000K	>80	No	60 x 108 mm	B22
LGS10/860B22	240V	10W	1050lm	270°	6500K	>80	No	60 x 108 mm	B22
LGS10/830E27	240V	10W	950lm	270°	2700K	>80	No	60 x 108 mm	E27
LGS10/840E27	240V	10W	1000lm	270°	4000K	>80	No	60 x 108 mm	E27
LGS10/860E27	240V	10W	1050lm	270°	6500K	>80	No	60 x 108 mm	E27

240V DIMMABLE GLS LED LAMP

LGS11D ECO SERIES DIMMABLE LAMP

CONSTRUCTION

- Similar size to incandescent GLS lamp
- Poly covered aluminium body
- Opal glass diffuser
- High efficiency SMD LED chips
- Wide beam angle
- Built-in LED driver
- Dimmable with trailing edge dimmer
- Suits most GLS lamp fittings

COLOUR TEMPERATURE

- 2700K WARM WHITE
- 6500K DAYLIGHT

LAMP BASE

- E27
- B22

DIMENSIONS

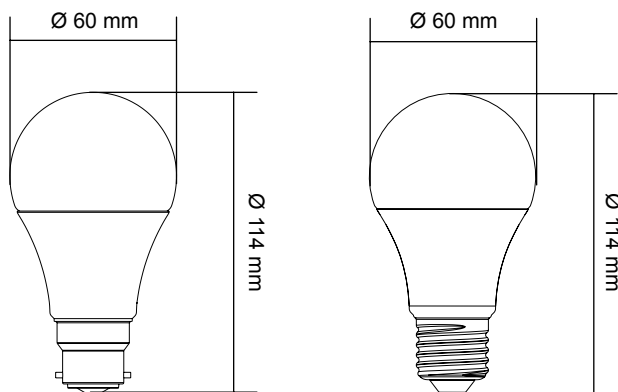

Model No.	Input	Power	Lumen	Beam Angle	CCT	CRI	Dimmable	Lamp Base
LGS11D/830B22	240V	11W	950lm	270°	2700K	>80	Yes	B22
LGS11D/860B22	240V	11W	1050lm	270°	6500K	>80	Yes	B22
LGS11D/830E27	240V	11W	950lm	270°	2700K	>80	Yes	E27
LGS11D/860E27	240V	11W	1050lm	270°	6500K	>80	Yes	E27

240V CANDLE LED LAMP

LCA35 CANDLE LED LAMP

CONSTRUCTION

- 1:1 size to traditional candle lamp
- Ceramic body
- Opal glass diffuser with silicon cover
- High efficiency LED chips
- High colour rendering
- Built-in LED driver
- Double insulation
- Suits most candle lamp fittings

COLOUR TEMPERATURE

- 3000K WARM WHITE
- 6000K DAYLIGHT

LAMP BASE

- E14
- E27
- B15
- B22

DIMENSIONS

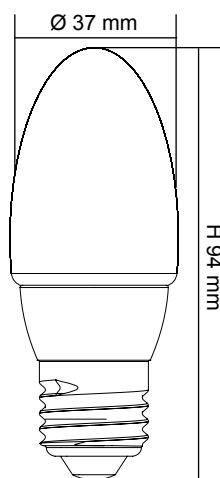

Model No.	Input	Power	Lumen	Beam Angle	CCT	CRI	Dimmable	Lamp Base
LCA35/930B15	240V	3W	300lm	160°	3000K	>90	No	B15
LCA35/960B15	240V	3W	300lm	160°	6000K	>90	No	B15
LCA35/930B22	240V	3W	300lm	160°	3000K	>90	No	B22
LCA35/960B22	240V	3W	300lm	160°	6000K	>90	No	B22
LCA35/930E14	240V	3W	300lm	160°	3000K	>90	No	E14
LCA35/960E14	240V	3W	300lm	160°	6000K	>90	No	E14
LCA35/930E27	240V	3W	300lm	160°	3000K	>90	No	E27
LCA35/960E27	240V	3W	300lm	160°	6000K	>90	No	E27

FANCY ROUND LED LAMP

LFR35 FANCY ROUND LED LAMP

CONSTRUCTION

- 1:1 size to traditional candle lamp
- Ceramic body
- Opal glass diffuser with silicon cover
- High efficiency LED chips
- High colour rendering
- Built-in LED driver
- Double insulation
- Suits most candle lamp fittings

COLOUR TEMPERATURE

- 3000K WARM WHITE
- 6000K DAYLIGHT

LAMP BASE

- E14
- E27
- B15
- B22

DIMENSIONS

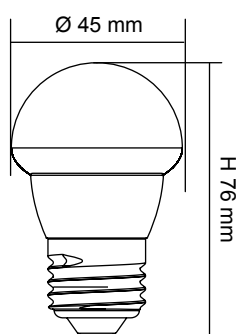

Model No.	Input	Power	Lumen	Beam Angle	CCT	CRI	Dimmable	Lamp Base
LFR35/930B15	240V	3W	300lm	120°	3000K	>90	No	B15
LFR35/960B15	240V	3W	300lm	120°	6000K	>90	No	B15
LFR35/930B22	240V	3W	300lm	120°	3000K	>90	No	B22
LFR35/960B22	240V	3W	300lm	120°	6000K	>90	No	B22
LFR35/930E14	240V	3W	300lm	120°	3000K	>90	No	E14
LFR35/960E14	240V	3W	300lm	120°	6000K	>90	No	E14
LFR35/930E27	240V	3W	300lm	120°	3000K	>90	No	E27
LFR35/960E27	240V	3W	300lm	120°	6000K	>90	No	E27

LED FILAMENT LAMP

LT25 FILAMENT TUBULAR LED LAMP

CONSTRUCTION

- Clear glass diffuser
- High efficiency LED filament
- High colour rendering
- 360° wide beam angle
- Built-in LED driver
- Suits most T25 lamp fittings
- Non-dimmable

COLOUR TEMPERATURE

- 3000K WARM WHITE

DIMENSIONS

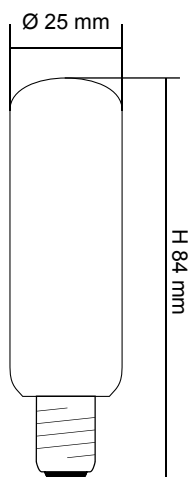

Model No.	Input	Power	Lumen	Beam Angle	CCT	CRI	Dimmable	Lamp Base
LT25F830E14	240V	2W	200lm	360°	3000K	>80	No	E14

LED FILAMENT LAMP

LCAF FILAMENT CANDLE LED LAMP



CONSTRUCTION

- Decorative glass diffuser
- High efficiency LED filament
- High colour rendering
- 360° wide beam angle
- Built-in LED driver
- Suits most candle shape lamp fittings

COLOUR TEMPERATURE

- 3000K WARM WHITE

LAMP BASE

- E27
- B22
- E14
- B15

DIMENSIONS

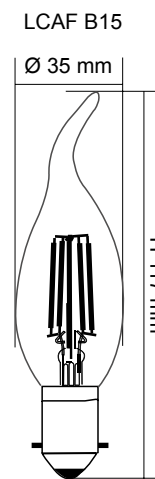
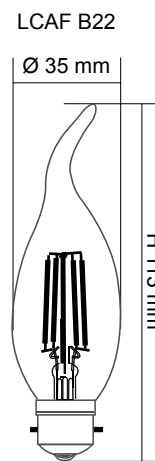
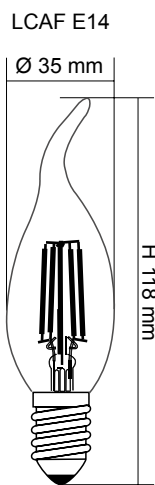
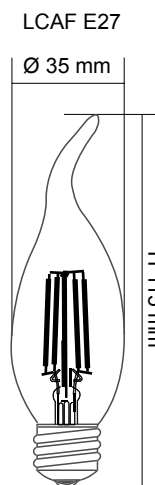

Model No.	Input	Power	Lumen	Beam Angle	CCT	CRI	Dimmable	Lamp Base
LCAF830E27	240V	4W	400lm	360°	3000K	>80	No	E27
LCAF830E14	240V	4W	400lm	360°	3000K	>80	No	E14
LCAF830B22	240V	4W	400lm	360°	3000K	>80	No	B22
LCAF830B15	240V	4W	400lm	360°	3000K	>80	No	B15

LED FILAMENT LAMP

LGF6 DIMMABLE FILAMENT GLS LED LAMP

CONSTRUCTION

- 1:1 size to traditional GLS lamp
- Clear glass diffuser
- High efficiency LED filament
- High colour rendering
- 300° wide beam angle
- Built-in dimmable LED driver
- Dimmable with trailing edge dimmer
- Suits most GLS lamp fittings

COLOUR TEMPERATURE

- 3000K WARM WHITE

LAMP BASE

- E27

DIMENSIONS

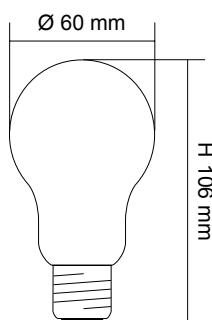

Model No.	Input	Power	Lumen	Beam Angle	CCT	CRI	Dimmable	Lamp Base
LGF6/830E27	240V~50Hz	6W	600lm	300°	3000K	>80	Yes	E27

LED FILAMENT LAMP

LG125F FILAMENT SPHERICAL LED LAMP

CONSTRUCTION

- 1:1 size to traditional spherical lamp
- Clear glass diffuser with LED filament
- High colour rendering
- 360° wide beam angle
- Built-in LED driver
- Suits most spherical lamp fittings

COLOUR TEMPERATURE

- 3000K WARM WHITE

LAMP BASE

- E27

DIMENSIONS

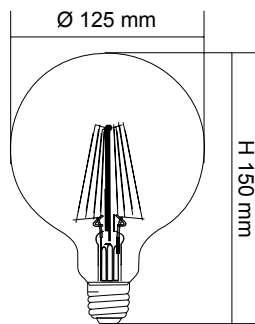

Model No.	Input	Power	Lumen	Beam Angle	CCT	CRI	Dimmable	Lamp Base
LG125F822E27	240V	8W	1000lm	360°	3000K	>80	No	E27

LED FILAMENT LAMP

LST21FD, LG125FD FILAMENT DECO LED LAMPS

CONSTRUCTION

- Glass diffuser with LED filament for decorative purposes
- High colour rendering
- 360° wide beam angle
- Built-in LED driver
- Champagne coloured glass for soft glow effect

COLOUR TEMPERATURE

- 2200K WARM WHITE

LAMP BASE

- E27

DIMENSIONS

LST21FD

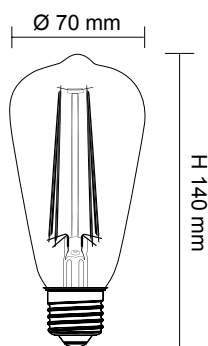

LG125FD

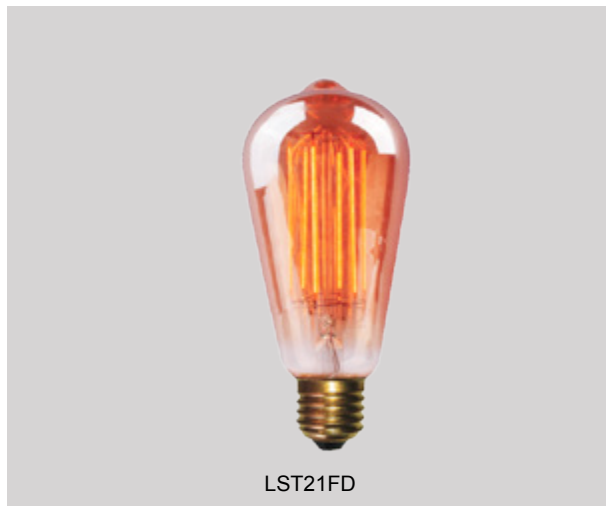
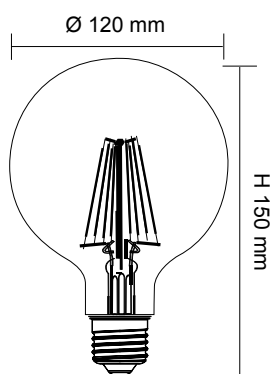

Model No.	Input	Power	Lumen	Beam Angle	CCT	CRI	Dimmable	Lamp Base
LST21FD822E27	240V	1W	100lm	360°	2200K	>80	No	E27

Model No.	Input	Power	Lumen	Beam Angle	CCT	CRI	Dimmable	Lamp Base
LG125FD822E27	240V	1W	100lm	360°	2200K	>80	No	E27

240V T8 LED TUBE

LT8/60, LT8/120 T8 LED TUBE

CONSTRUCTION

- Fit new T8 LED light or retrofit T8 fluorescent light (Magnetic Ballast)
- 320° beam angle
- Full glass body with shatter proof poly coating
- Built-in LED driver
- No flicker, instant start
- Safety LED fuse included

COLOUR TEMPERATURE

- 3000K WARM WHITE
- 4000K COOL WHITE
- 6000K DAYLIGHT

LAMP BASE

- G13



DIMENSIONS

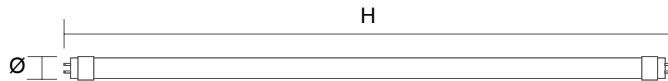

WIRING DIAGRAM

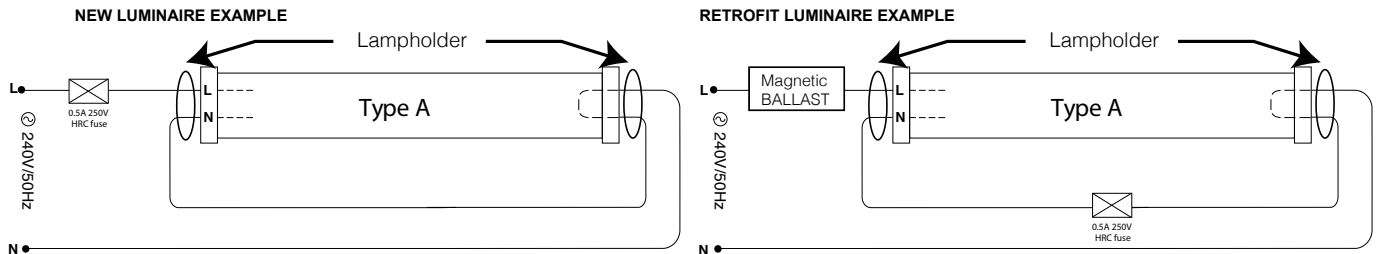

Model No.	Input	Power	Lumen	Beam Angle	CCT	CRI	Dimmable	Dimensions Ø x H	Lamp Base
LT8/60 WW	240V	9W	900lm	320°	3000K	>80	No	600 x 26 mm	G13
LT8/60 CW	240V	9W	950lm	320°	4000K	>80	No	600 x 26 mm	G13
LT8/60 DL	240V	9W	1000lm	320°	6000K	>80	No	600 x 26 mm	G13

Model No.	Input	Power	Lumen	Beam Angle	CCT	CRI	Dimmable	Dimensions Ø x H	Lamp Base
LT8/120 WW	240V	18W	1800lm	320°	3000K	>80	No	1200 x 26 mm	G13
LT8/120 CW	240V	18W	1900lm	320°	4000K	>80	No	1200 x 26 mm	G13
LT8/120 DL	240V	18W	2000lm	320°	6000K	>80	No	1200 x 26 mm	G13



12V AR111 LED LAMP

AR111 LED LAMP

CONSTRUCTION

- Poly covered aluminium body
- High efficiency COB LED chip
- Specially designed optical lens
- Standard beam angle 24°
- 12V AC or DC driver required
- Compatible with leading brand electronic transformer
- Suits most halogen AR111 lamp fittings

COLOUR TEMPERATURE

- 3000K WARM WHITE

BEAM ANGLE OPTION

- 40° optical lens



AR111/700

LAMP BASE

- G53

DIMENSIONS

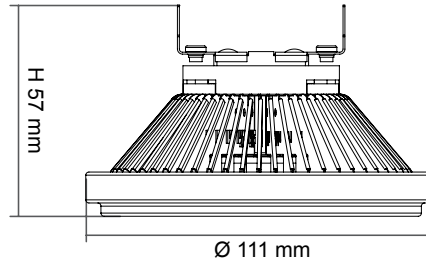

Model No.	Input	Power	Lumen	Beam Angle	CCT	CRI	Dimmable
AR111/700	12V AC or DC	12W	750lm	24°	3000K	>80	Yes

CONSTANT CURRENT AR111 LED MODULE

AR111 LED MODULES

CONSTRUCTION

- Die-cast aluminium body
- High efficiency COB LED chip
- Specially designed optical lens
- Standard beam angle 24°
- Changeable reflector for different beam angle
- Constant current LED driver required

COLOUR TEMPERATURE

- 3000K WARM WHITE
- 4000K COOL WHITE

BEAM ANGLE OPTIONS

- 40° reflector (AR111//1700)
- 20° & 60° reflector (AR111/3500)

DIMENSIONS

AR111/1700

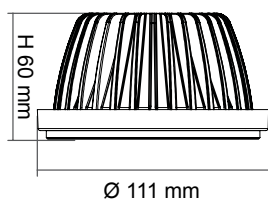

AR111/3500

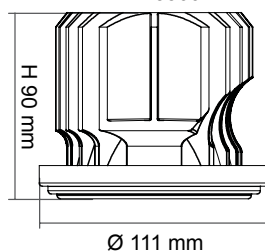

AR111/1700



AR111/3500

Model No.	Input	Power	Lumen	Beam Angle	CCT	CRI
AR111/1700	500mA	20W	1700lm	24°	3000K/4000K	>80
AR111/3500	500mA	35W	3300lm	40°	3000K/4000K	>80

Specifications above are for reference only and may vary without prior notice

LED CONVERSION KITS

SLC21, SLC30 CONVERSION KITS

CONSTRUCTION

- 240V LED conversion kit
- Aluminium heat sink mounted base
- High efficiency SMD LED chips
- High colour rendering
- Constant current LED driver included
- IP20 suitable for indoor use only
- Suits most ceiling oyster fittings

OPTION

- Trailing edge dimming

DIMENSIONS

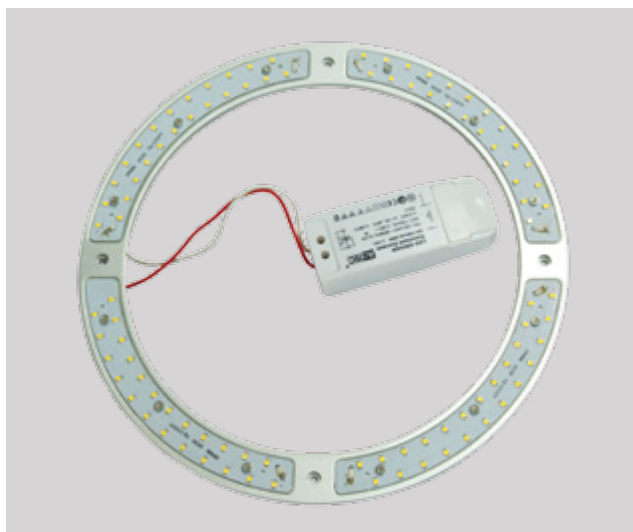
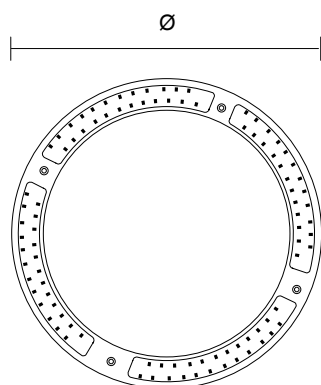

Model No.	Input	Power	Lumen	CCT	CRI	Dimmable	Dimensions Ø
SLC21/WW	240V	12W	1200lm	3000K	>80	No	210 mm
SLC21/CW	240V	12W	1200lm	4000K	>80	No	210 mm
SLC21/DL	240V	12W	1200lm	6000K	>80	No	210 mm
SLC30/WW	240V	20W	1800lm	3000K	>80	No	300 mm
SLC30/CW	240V	20W	1800lm	4000K	>80	No	300 mm
SLC30/DL	240V	20W	1800lm	6000K	>80	No	300 mm

CONSTANT VOLTAGE LED DRIVER

PLUTO, PLUTO EGL CONSTANT VOLTAGE LED DRIVER

- Independent compact design
- Easy press cable lock
- Captured terminal screws
- Safe no load operation
- Overload protection
- Short circuit protection
- Overheating protection
- SELV equivalent
- EMC compliant

WIRING DIAGRAM

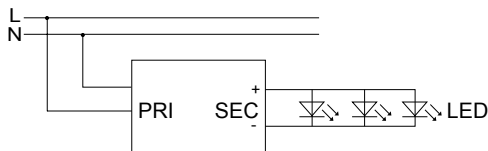

DIMENSIONS

PLUTO EGL 12V(24V)/6W(15W)

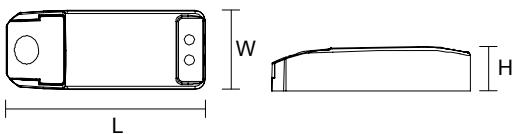

PLUTO 50W/12V(24V)

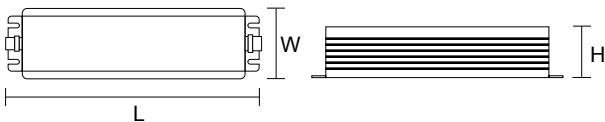

PLUTO 30/(100/200)W/12V(24V)

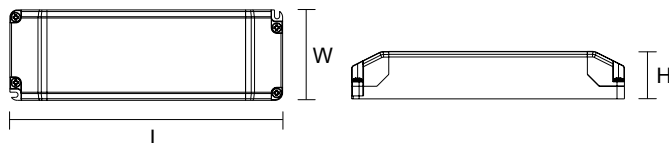

PLUTO EGL 12V(24V)/6W(15W)



PLUTO 50W/12V(24V)



PLUTO 30/(100/200)W/12V(24V)

Model No.	Input	Power	Output	Power Factor	Dimensions L x W x H	IP Rating
PLUTO EGL 12V/6W	240V	6W	12V	0.6	98 x 40 x 22 mm	20
PLUTO EGL 12V/15W	240V	15W	12V	0.8	113 x 44 x 28 mm	20
PLUTO EGL 24V/15W	240V	15W	24V	0.8	113 x 44 x 28 mm	20
PLUTO 50W/12V	240V	50W	12V	0.95	184 x 61 x 32 mm	20
PLUTO 50W/24V	240V	50W	24V	0.95	184 x 61 x 32 mm	20
PLUTO 30W/12V	240V	30W	12V	0.95	185 x 55 x 30 mm	67
PLUTO 30W/24V	240V	30W	24V	0.95	185 x 55 x 30 mm	67
PLUTO 100W/12V	240V	100W	12V	0.95	192 x 70 x 42 mm	67
PLUTO 100W/24V	240V	100W	24V	0.95	192 x 70 x 42 mm	67
PLUTO 200W/12V	240V	200W	12V	0.95	234 x 126 x 57 mm	67
PLUTO 200W/24V	240V	200W	24V	0.95	234 x 126 x 57 mm	67

DIMMABLE CONSTANT VOLTAGE DRIVER

DIM40W/12V DIMMABLE CONSTANT VOLTAGE DRIVER

- Independent compact design
- Trailing edge dimming
- Safe no load operation
- Overload protection
- Short circuit protection
- Overheating protection
- SELV equivalent
- EMC compliant
- Output wire leads
- Double insulation
- 1.2 m flex & 2 pin plug fitted

RECOMMENDED DIMMERS

- SDA450
- SDD350TCM

IP RATING

- IP65 weatherproof

DIMENSIONS

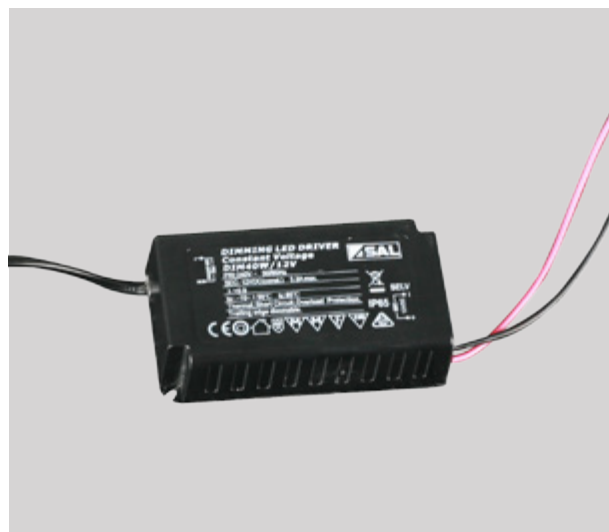
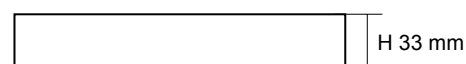
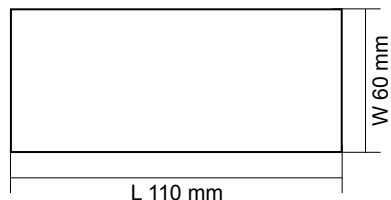

Model No.	Input	Output Power	Output	Power Factor
DIM40W/12V	240V~50Hz	40W	12V DC	>0.90

DIMMABLE CONSTANT CURRENT LED DRIVERS

PLUTO, DIM DIMMABLE CONSTANT CURRENT LED DRIVERS

- Independent compact design
- Easy press cable lock
- Captured terminal screws
- Safe no load operation
- Overload protection
- Short circuit protection
- Overheating protection
- SELV equivalent
- EMC compliant
- Dimmable with trailing edge dimmer
- Dimming range 10%~100%

IP RATING

- IP20

RECOMMENDED DIMMERS

- SDA450
- SDD350TCM

WIRING DIAGRAM

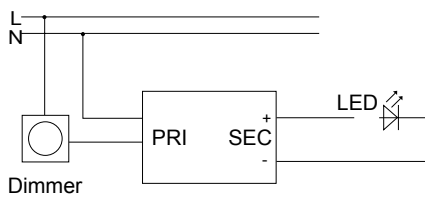

DIMENSIONS

DIM700mA/36W

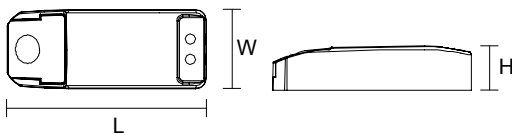

DIM1400mA/36W

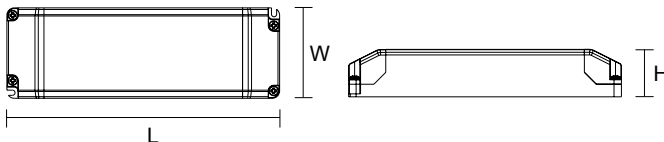

Model No.	Input	Max. Output Power	Output	Output Current	Power Factor	Dimensions L x W x H
PLUTO DIM350mA/12W	240V	12W	12~35V	350mA	0.90	113 x 44 x 28 mm
PLUTO DIM350mA/18W	240V	18W	15~52V	350mA	0.90	113 x 44 x 28 mm
PLUTO DIM500mA/18W	240V	18W	9~36V	500mA	0.90	113 x 44 x 28 mm
PLUTO DIM700mA/18W	240V	18W	6~26V	700mA	0.90	113 x 44 x 28 mm
DIM700mA/36W	240V	36W	24~52V	700mA	0.90	166 x 52 x 24 mm
DIM1400mA/36W	240V	36W	9~26V	1400mA	0.90	166 x 52 x 24 mm

ELECTRONIC TRANSFORMERS

MINI ELECTRONIC TRANSFORMERS

- Independent compact design
- Captured terminal screws
- High efficiency (95%)
- Safe no load operation
- Overload protection
- Short circuit protection
- Overheating protection
- SELV equivalent
- EMC compliant
- Dimmable with trailing edge dimmer
- Dimming range 10%~100%

IP RATING

- IP20 suitable for indoor use only

RECOMMENDED DIMMERS

- SDA450
- SDD350TCM

DIMENSIONS

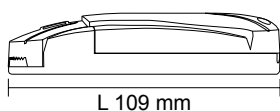
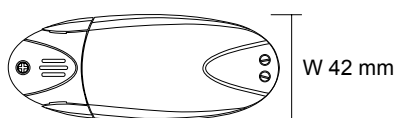

Model No.	Input	Power	Output	Input Current	Power Factor	1.2 m Flex & PlugFitted
MINI60	240V	20-60W	11.5V	0.26mA	0.99	No
MINI/P60	240V	20-60W	11.5V	0.26mA	0.99	Yes

MAGNETIC WEATHERPROOF AC-AC TRANSFORMER

ST105, ST150, ST200, ST300, ST400

- Magnetic weatherproof AC-AC transformer
- Safe no load operation
- Overload protection
- Short circuit protection
- Overheating protection
- SELV equivalent
- EMC compliant
- 1.2 m flex & plug fitted

IP RATING

- IP66

DIMENSIONS

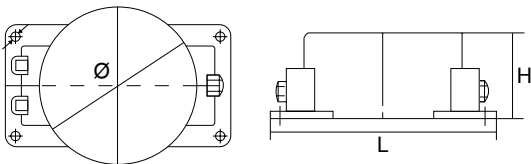

Model No.	Input	Power	Output	Max. Current	Dimensions Ø x L x H
ST105	240V	105W	12V	8.75A	124 x 195 x 80 mm
ST150	240V	150W	12V	12.50A	124 x 195 x 80 mm
ST200	240V	200W	12V	16.67A	138 x 210 x 80 mm
ST300	240V	300W	12V	25.00A	138 x 210 x 80 mm
ST400	240V	400W	12V	33.33A	152 x 225 x 80 mm

LED EMERGENCY KIT

SELK2500/SM TRIANGLE LED EMERGENCY KIT

- Compliant to AS2293
- Emergency classification: D32
- LED charge status indicator
- Test switch with self-test function
- 3 hours emergency operation
- Intelligent automatic recharging function
- 16 hours charge time
- Deep discharge protection
- SELV classified

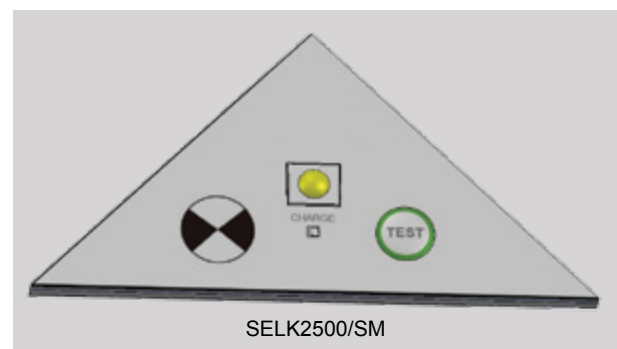

Model No.	Input	Power	Lumen	CCT	CRI	Beam Angle	Battery	Battery Voltage
SELK2500/SM	240V	3W	200lm	6000K	>80	120°	2500mAh	4.8V

LED EMERGENCY KIT

SELK1500/SF S-FIRE

- Die-cast aluminium body
- Powder coated finish
- Constant current mode
- 3 hours emergency operation
- Intelligent automatic recharging function
- LED charge status display
- 16 hours charge time
- Deep discharge protection
- Test switch with self-test function
- SELV classified (outputs LED, battery, status LED, test switch)
- Emergency controller and battery included
- 1.2 m flex & plug fitted
- Comply with AS2293
- Emergency classification: D25



IP RATING

- IP20 suitable for indoor use only

DIMENSIONS

EMERGENCY LED DISK

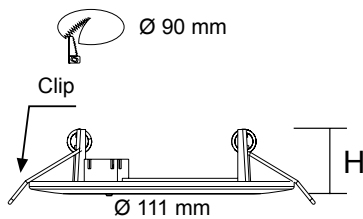

OPTION: SURFACE MOUNTED CANISTER

DIMENSIONS

S9063 SM WH-CASE



WIRING DIAGRAM

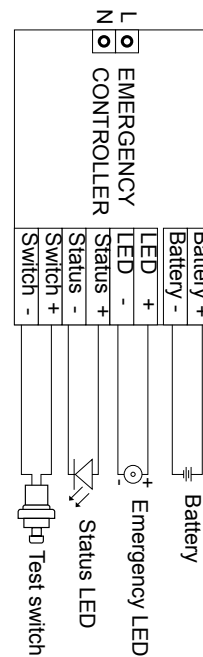

Model No.	Input	Input Current	System Power	Charge Current	Recharge Hours	EM LED Current LED	EM LED Power LED	Battery Type	Emergency Classification
SELK1500/SF	240V	30mA	2W	160mA	16h	600mA	1.8W	Ni-Cd 4.8V 1.5Ah	D25

DIGITAL DIMMER

350W TRAILING EDGE MASTER & SECONDARY

SDD350TCM, SDD350TCS TRAILING EDGE DIMMER

- Multiple-location dimming by connecting SDD350TCM with any number of secondary dimmers SDD350TCS as shown in “Wiring Diagram”
- Fit most branded switch plates
- Additional button cover included
- Overheating protection
- Over current protection
- Full short circuit protection
- Colour temperature changeable with S9841 LED downlight
- Complies with Australian Standard AS/NZS60669.2.1
- Dual function
 - 1.Change colour temperatures between 3000K, 4000K & 5700K with suitable downlight (double click)
 - 2.Dimming up or down light output (long press)



DIMENSIONS

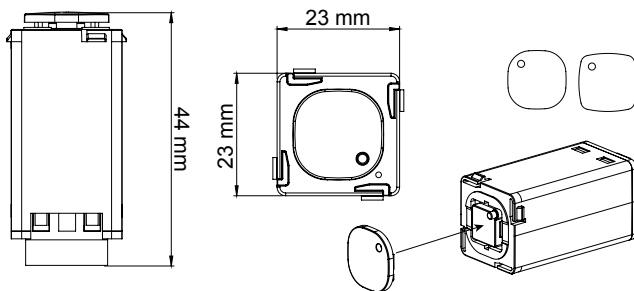

SAL offers push buttons to suit HPM & Clipsal style wall plates.

WIRING DIAGRAM

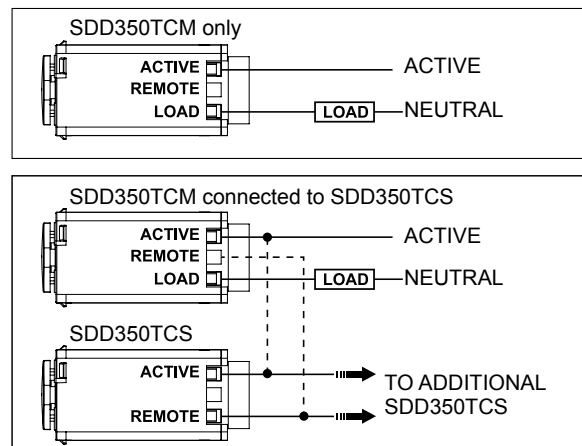

Note: An unlimited number of SDD350TCS can be connected to a SDD350TCM. However the total length of the remote wire (>0.5 mm²) used to interconnect all of the SDD350TCS should not exceed 50 metres.

Model No.	Input	Frequency	Max. Load	Min. Load	Dimming Technique
SDD350TCM	240V	50Hz/60Hz	350W	2W*	Trailing edge phase control

*Dimming performance will be affected when the load is less than 2W. (AT 25°C)

DIMMERS

SDA450

- Trailing edge analogue dimmer
- 240V 450W
- Dimensions: 23 x 23 x 53 mm

SDF30

- Analogue 1-10V dimming switch
- Dimensions: 25 x 25 x 32 mm



QUICK CONNECT SURFACE SOCKET

ESS101 QUICK CONNECT SURFACE SOCKET

- Standard surface socket with mounting plate
- 240V 10A surface socket

INSTALLATION INSTRUCTIONS

1. Remove a slight piece of outer sheathing ONLY to check wire colours for polarity identification.

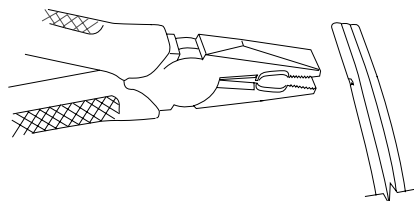

2. Rotate the rear cover to take off the locking ring. Note: When connecting 2.5 mm² cable, the 1.5mm² cable size insert needs to be taken off.

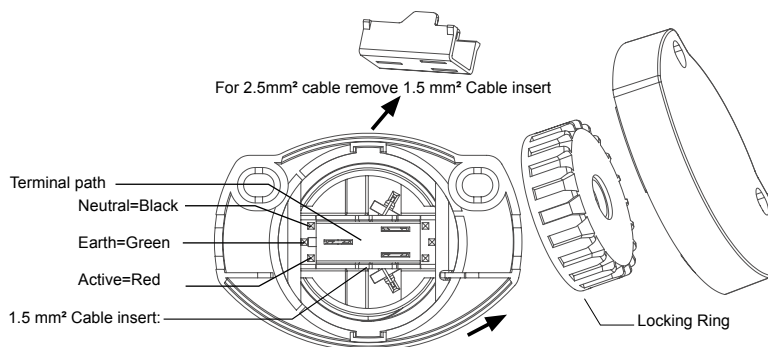

3. Place cable into terminal path. Ensure correct polarity by following colour coding on the terminal path.

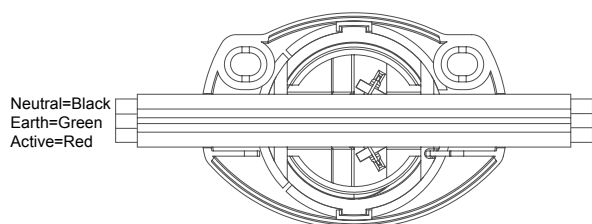

4. Align rectangle ribs with terminal path, push the locking ring and rear cover back down & twist clockwise until it is firmly tightened with the body.

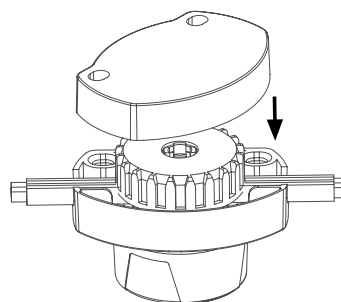

SURFACE SOCKET

ESS102 SURFACE SOCKET

- Standard surface socket with mounting plate
- 240V 10A surface socket



2 PIN FLEX & PLUG 2S9000

- 2 x 0.75 mm²



3 PIN FLEX & PLUG 3S9000

- 3 x 0.75 mm²



GU10 LAMPHOLDER 250V MAX 2A SGU9000LH

ES TO BI-PIN LAMPHOLDER CONVERTER M/LV

E27 LAMPHOLDER 250V MAX 100W SLH100



ADAPTOR PLATES S9901, S9903

- Pressed steel plate
- Powder coated finish
- Available colours:
White, Black, Chrome, Gold, Satin Nickel

S9901

- Adaptor plate to suit S9001, S9040, S9045

S9903

- Adaptor plate to suit S9003, S9041, S9046, S9048

DIMENSIONS

S9901

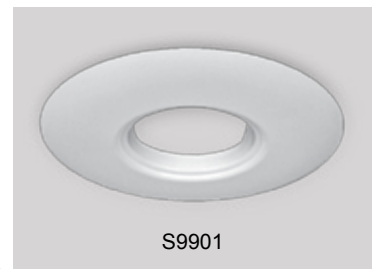
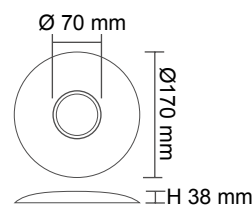

S9903

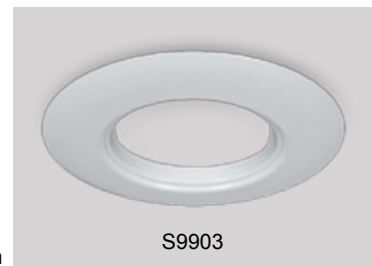
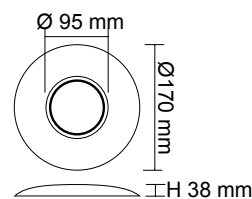

REDUCE RING S9922

- Adaptor plate to suit S9522
- Available colours: White

DIMENSIONS

S9922

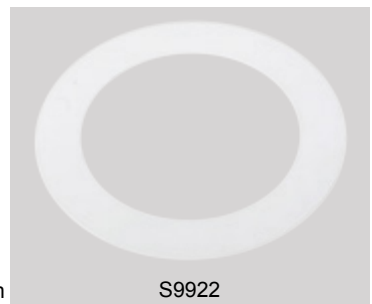
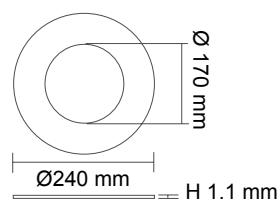

SUSPENSION UNITS

SSI1512, SSY1512

- M10 size ceiling attachment
- 1.2 mm stainless steel cable carrying weight up to 45 kg
- M10 size griplock system

DIMENSIONS

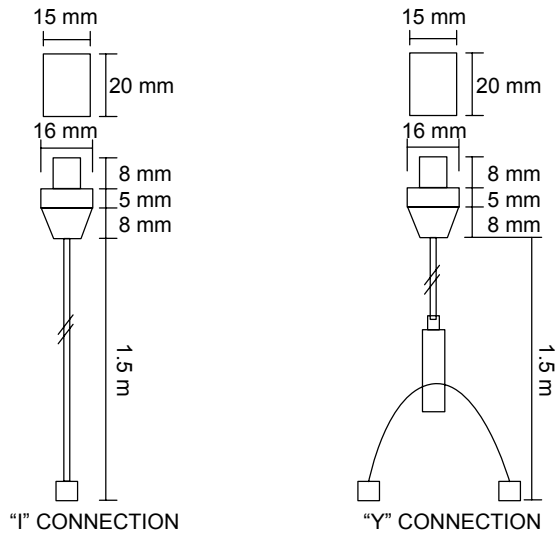

ALUMINIUM CONCRETE CAN

S9913

- Suitable fittings: S9003, S9041, S9141, S9046, S9065, S9071, S9048

DIMENSIONS

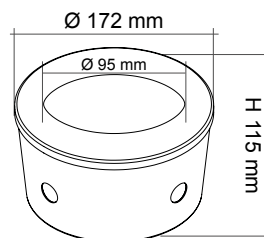

MICROWAVE MOTION SENSORS

SMS800 SENSOR

Operating voltage	240V
Switched power	1000W incandescent, 300W Fluorescent, 200W LED
Standby power	<1W
Detection distance	Max. 12 m in diameter
Detection range	10 / 25 / 50 / 75 / 100% adjustable
Detection angle	150°
Duration Time	5sec / 30sec / 1min / 5min / 15min / 30min adjustable
Lux threshold	Disable / 2lux / 5lux / 10lux / 30lux / 50lux adjustable
Sensor principle	Microwave motion detector
Material	PC
Microwave power	<1mw
Mounting Method	Surface mounted
Mounting height	Max. 6 m
Operating temperature	-30° ~ +70°C
IP rating	IP20



DIMENSIONS

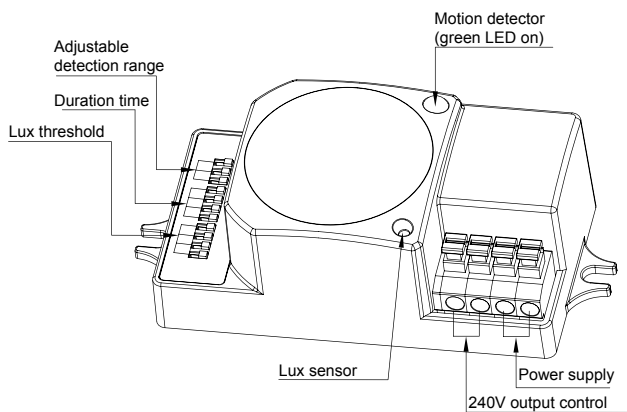
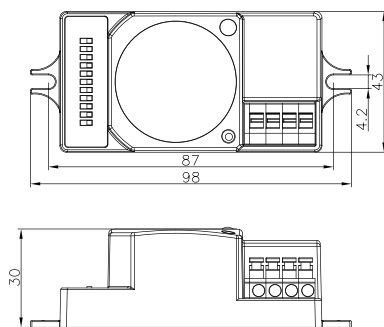

WIRING DIAGRAM

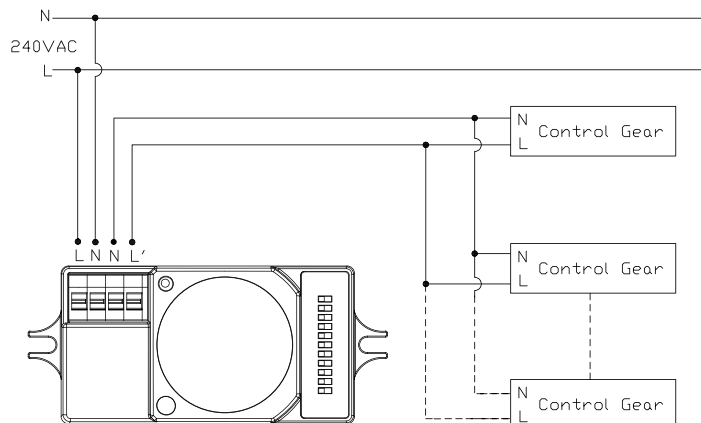

DETECTION RANGE

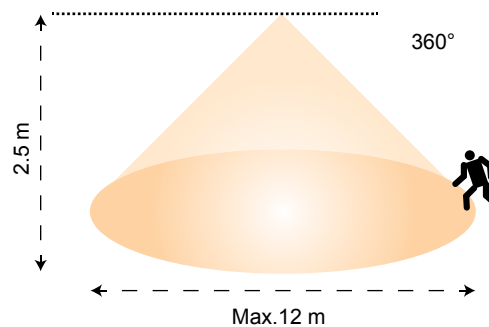

MICROWAVE MOTION SENSORS

SMS810 SENSOR

Operating voltage	240V
Switched power	1000W incandescent, 300W Fluorescent, 200W LED
Standby power	<1W
Detection distance	Max. 16 m in diameter
Detection range	0 ~ 100% adjustable
Detection angle	360°
Duration Time	10 sec to 10 mins adjustable
Lux threshold	Dawn to dusk adjustable
Sensor principle	Microwave motion detector
Material	PC
Microwave power	<1mw
Mounting Method	Surface mounted
Mounting height	Max. 8 m
Operating temperature	-15° ~ +70°C
IP rating	IP20



DIMENSIONS

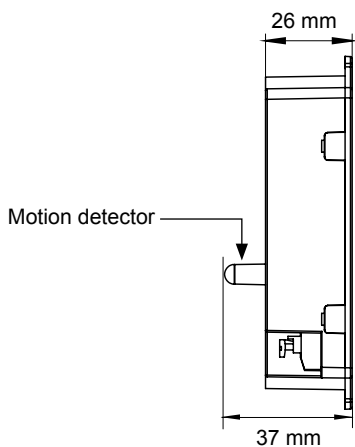
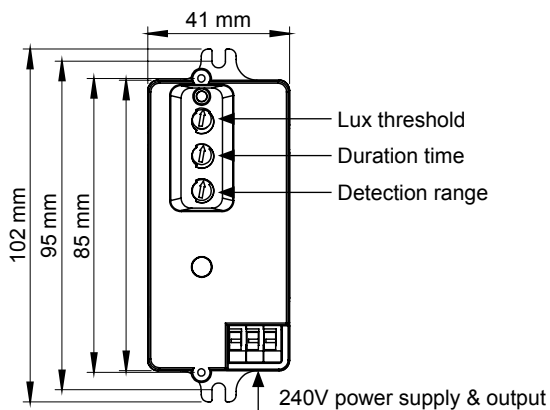

WIRING DIAGRAM

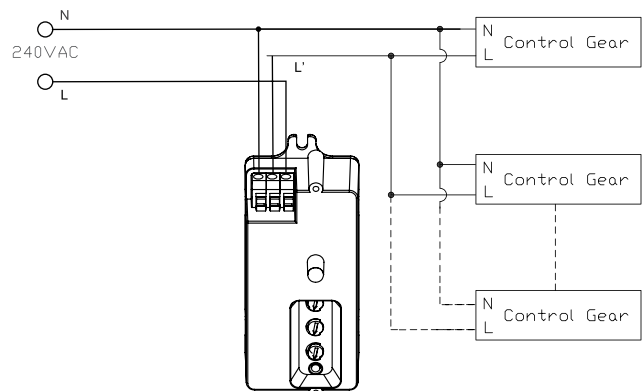

DETECTION RANGE

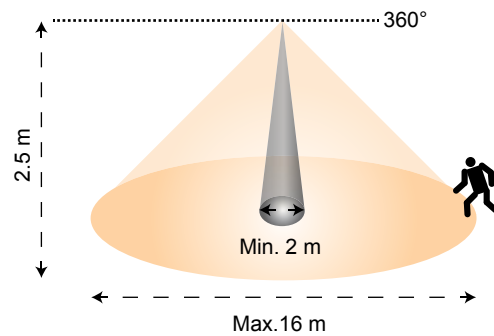

DETECTION ANGLE

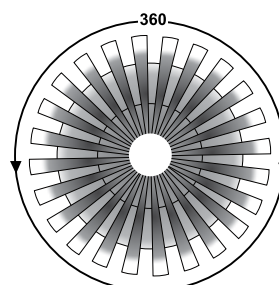

INFRARED SENSORS – SURFACE MOUNTED

SMS801WF SENSOR

Operating voltage	240V
Switched power	1000W incandescent, 300W Fluorescent, 150W LED
Standby power	<1W
Detection distance	Max. 12 m
Detection angle	Approx. 180° horizontal, 60° vertical
Duration Time	10 sec to 4 mins adjustable
Lux threshold	Dawn to dusk adjustable
Sensor principle	Infrared sensor
Material	PC
Mounting Method	Surface mounted
Mounting height	Max. 6 m
Operating temperature	-10° ~ +40°C
IP rating	IP44



DIMENSIONS

SMS801WF

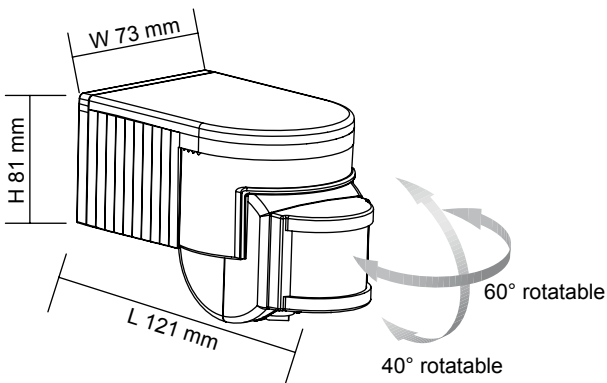

WIRING DIAGRAM

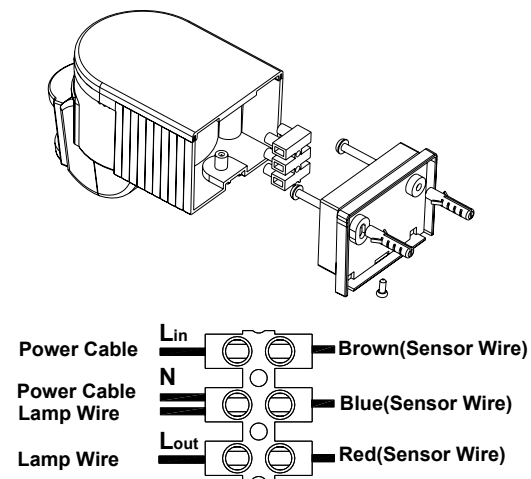

MANUAL OVERRIDE MODE

- When the lamp(s) is switched on, turn the lamp(s) on/off twice within 3 seconds, the sensor will go to an 8 hour override mode, during which the lamp(s) will stay on. The sensor will then return to normal detection mode
- During override mode, turn the lamp(s) on/off twice within 3 seconds or turn off the lamp(s) for over 10 seconds, the sensor will return to normal detection mode

DETECTION RANGE

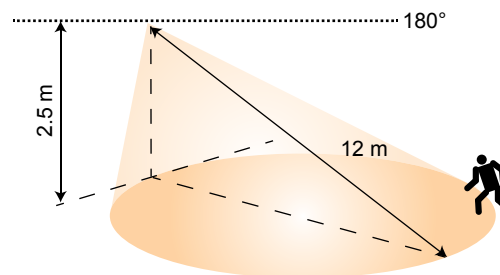

INFRARED SENSORS – SURFACE MOUNTED

SMS802WR SENSOR

Operating voltage	240V
Switched power	1000W incandescent, 300W Fluorescent, 150W LED
Standby power	<1W
Detection distance	Max. 10 m
Detection angle	Approx. 180° horizontal, 60° vertical
Duration Time	10 sec to 4 mins adjustable
Lux threshold	Dawn to dusk adjustable
Sensor principle	Infrared sensor
Material	ABS
Mounting Method	Surface mounted
Mounting height	Max. 5 m
Operating temperature	-10° ~ +40°C
IP rating	IP44



DIMENSIONS

SMS802WR

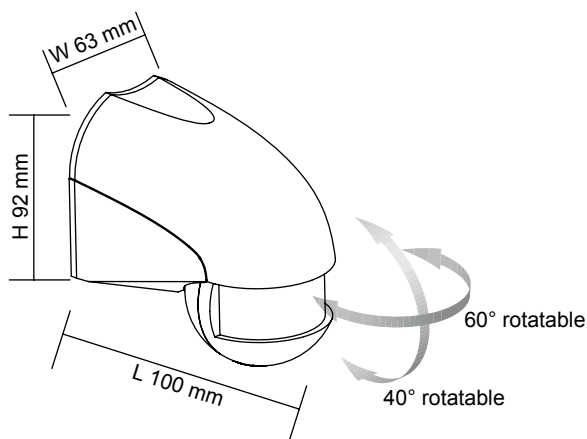

WIRING DIAGRAM

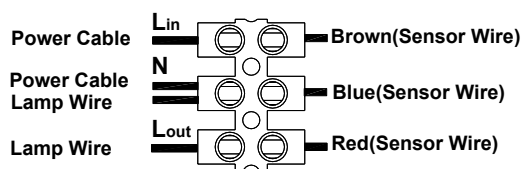
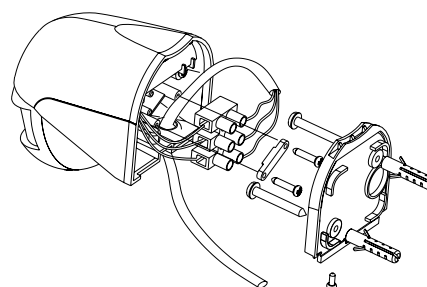

MANUAL OVERRIDE MODE

- When the lamp(s) is switched on, turn the lamp(s) on/off twice within 3 seconds, the sensor will go to an 8 hour override mode, during which the lamp(s) will stay on. The sensor will then return to normal detection mode
- During override mode, turn the lamp(s) on/off twice within 3 seconds or turn off the lamp(s) for over 10 seconds, the sensor will return to normal detection mode

DETECTION RANGE

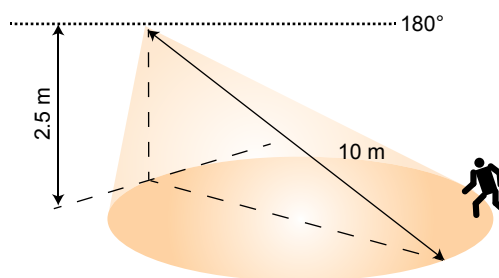

INFRARED SENSORS – SURFACE / RECESSED OCCUPANCY

SMS803CD SENSOR

Operating voltage	240V
Switched power	2000W incandescent, 600W Fluorescent, 300W LED
Standby power	<1W
Detection distance	Max. 18 m in diameter for normal detection Max. 6 m in diameter for occupancy detection
Detection angle	360°
Duration Time	10 sec to 40 mins adjustable
Lux threshold	Dawn to dusk adjustable
Sensor principle	3 x Infrared sensor
Material	PC
Mounting Method	Surface mounted or recessed
Mounting height	Max. 9 m
Operating temperature	-10° ~ +40°C
IP rating	IP20



DIMENSIONS

SMS803CD – surface mounted

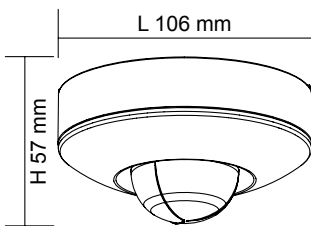

SMS803CD – recessed

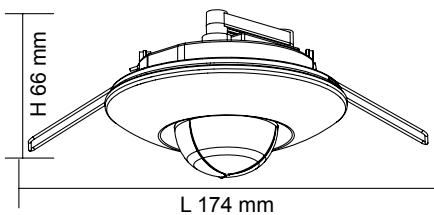

WIRING DIAGRAM

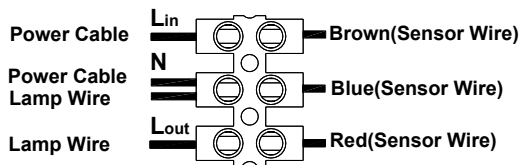
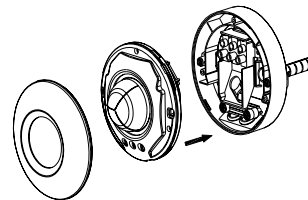

MANUAL OVERRIDE MODE

- When the lamp(s) is switched on, turn the lamp(s) on/off twice within 3 seconds, the sensor will go to an 8 hour override mode, during which the lamp(s) will stay on. The sensor will then return to normal detection mode
- During override mode, turn the lamp(s) on/off twice within 3 seconds or turn off the lamp(s) for over 10 seconds, the sensor will return to normal detection mode

DETECTION RANGE

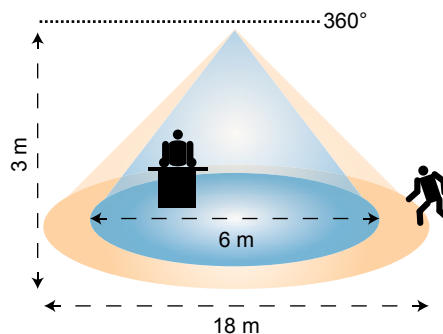

INFRARED SENSORS – RECESSED

SMS804CR SENSOR

Operating voltage	240V
Switched power	2000W incandescent, 500W Fluorescent, 300W LED
Standby power	<1W
Detection distance	Max. 9 m in diameter
Detection angle	360°
Duration Time	10 sec to 4 mins adjustable
Lux threshold	Dawn to dusk adjustable
Sensor principle	Infrared sensor
Material	PC
Microwave power	<1mw
Mounting Method	Recessed
Mounting height	Max. 4.5 m
Operating temperature	-10° ~ +40°C
IP rating	IP20



DIMENSIONS

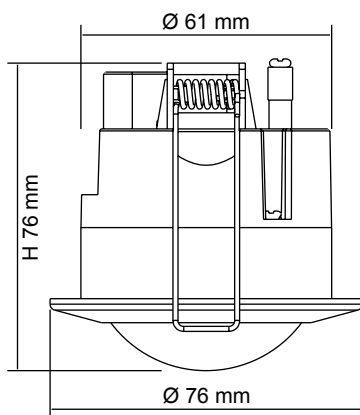

WIRING DIAGRAM

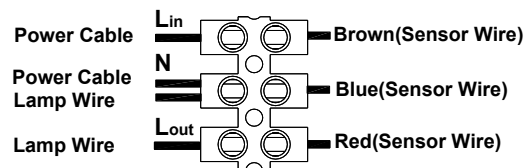

MANUAL OVERRIDE MODE

- When the lamp(s) is switched on, turn the lamp(s) on/off twice within 3 seconds, the sensor will go to an 8 hour override mode, during which the lamp(s) will stay on. The sensor will then return to normal detection mode
- During override mode, turn the lamp(s) on/off twice within 3 seconds or turn off the lamp(s) for over 10 seconds, the sensor will return to normal detection mode

DETECTION RANGE

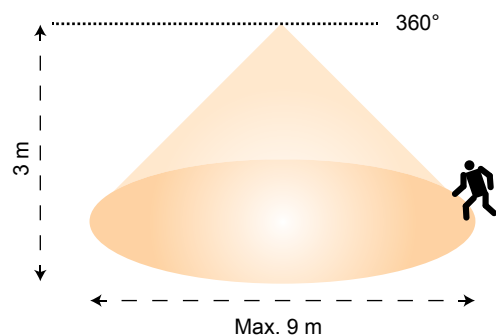

INFRARED SENSORS – SURFACE MOUNTED

SMS805CS SENSOR

Operating voltage	240V
Switched power	1600W incandescent, 500W Fluorescent, 200W LED
Standby power	<1W
Detection distance	Max. 12 m in diameter
Detection angle	360°
Duration Time	10 sec to 4 mins adjustable
Lux threshold	Dawn to dusk adjustable
Sensor principle	Infrared sensor
Material	PC
Microwave power	<1mw
Mounting Method	Surface mounted
Mounting height	Max. 6 m
Operating temperature	-10° ~ +40°C
IP rating	IP20



DIMENSIONS

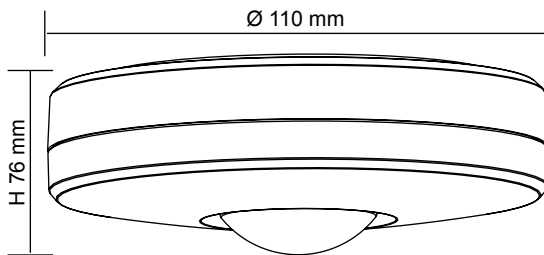

WIRING DIAGRAM

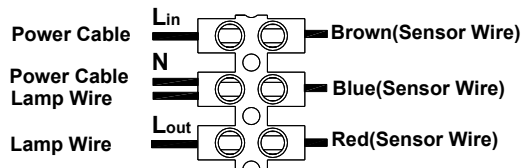

MANUAL OVERRIDE MODE

- When the lamp(s) is switched on, turn the lamp(s) on/off twice within 3 seconds, the sensor will go to an 8 hour override mode, during which the lamp(s) will stay on. The sensor will then return to normal detection mode
- During override mode, turn the lamp(s) on/off twice within 3 seconds or turn off the lamp(s) for over 10 seconds, the sensor will return to normal detection mode

DETECTION RANGE

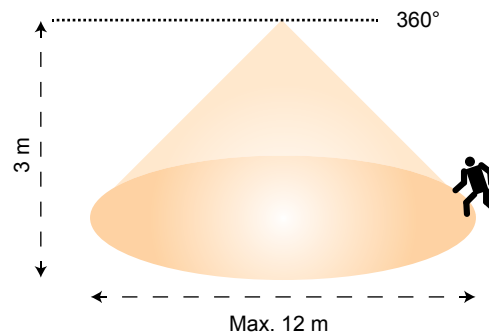

INDEX

2S9000	270	GU10LA750DL	48
3S9000	270	GU10LA750DL	242
AR111/700	260	GU10LA750WW	48
AR111/1700	260	GU10LA750WW	242
AR111/3500	260	GU10LR750DL	48
CONVERTER M/LV	270	GU10LR750DL	242
DIM40W/12V	263	GU10LR750WW	48
DIM700MA/36W	264	GU10LR750WW	242
DIM1400MA/36W	264	GX53/450 CW	244
ESS101	269	GX53/450 DL	244
ESS102	269	GX53/450 WW	244
FL1206BU/S	146	L21011 WW WH	39
FL1206GN/S	146	L21012 WW WH	39
FL1206RD/S	146	L21021 WW WH	39
FL1209CW/S	145	L21022 WW WH	39
FL1209CW/SR	145	LCA35/930B15	252
FL1209DL/S	145	LCA35/930B22	252
FL1209DL/SR	145	LCA35/930E14	252
FL1209WW/S	145	LCA35/930E27	252
FL1209WW/SR	145	LCA35/960B15	252
FL2415RGB/S	147	LCA35/960B22	252
FLC 400 RGB	152	LCA35/960E14	252
FLC 400 S	152	LCA35/960E27	252
FLH2420 CW	148	LCAF830B15	255
FLH2420 DL	148	LCAF830B22	255
FLH2420 WW	148	LCAF830E14	255
FLP12V2M/NDL/S	149	LCAF830E27	255
FLP12V2M/WW/S	149	LFR35/930B15	253
FLP12V5M/NDL/S	149	LFR35/930B22	253
FLP12V5M/RGB	150	LFR35/930E14	253
FLP12V5M/WW/S	149	LFR35/930E27	253
G4L15DL	243	LFR35/960B15	253
G4L15WW	243	LFR35/960B22	253
G4L25DL	243	LFR35/960E14	253
G4L25WW	243	LFR35/960E27	253
G9L3D/ DL	243	LG3/830B22	249
G9L3D/ WW	243	LG3/830E27	249
GU10L350DL	48	LG3/860B22	249
GU10L350DL	242	LG3/860E27	249
GU10L350WW	48	LG5/830B22	249
GU10L350WW	242	LG5/830E27	249
GU10L550DL	48	LG5/860B22	249
GU10L550DL	242	LG5/860E27	249
GU10L550WW	48	LG7/830B22	249
GU10L550WW	242	LG7/830E27	249

INDEX

LG7/860B22	249	LR50DL	246
LG7/860E27	249	LR50WW	246
LG9/830B22	249	LR63DL	246
LG9/830E27	249	LR63WW	246
LG9/860B22	249	LR80DL	246
LG9/860E27	249	LR80WW	246
LG95/830B22	248	LR95DL	246
LG95/830E27	248	LR95WW	246
LG95/860B22	248	LST21FD822E27	258
LG95/860E27	248	LT8/60 CW	259
LG125/830B22	248	LT8/60 DL	259
LG125/830E27	248	LT8/60 WW	259
LG125/860B22	248	LT8/120 CW	259
LG125/860E27	248	LT8/120 DL	259
LG125F822E27	257	LT8/120 WW	259
LG125FD822E27	258	LT25F830E14	254
LGF6/830E27	256	LT407/27B22	245
LGS4/830B22	250	LT407/27E27	245
LGS4/830E27	250	LT407/40B22	245
LGS4/840B22	250	LT407/40E27	245
LGS4/840E27	250	LT407/65B22	245
LGS4/860B22	250	LT407/65E27	245
LGS4/860E27	250	LT409/27B22	245
LGS8/830B22	250	LT409/27E27	245
LGS8/830E27	250	LT409/40B22	245
LGS8/840B22	250	LT409/40E27	245
LGS8/840E27	250	LT409/65B22	245
LGS8/860B22	250	LT409/65E27	245
LGS8/860E27	250	LT8903 DIM	153
LGS10/830B22	250	LT8903 RGB	153
LGS10/830E27	250	LT8904 DIM/RP	155
LGS10/840B22	250	LT8904 RGB/RP	155
LGS10/840E27	250	LT8905 DIM	157
LGS10/860B22	250	LT8905 RGB	157
LGS10/860E27	250	MINI60	49
LGS11D/830B22	251	MINI60	50
LGS11D/830E27	251	MINI60	265
LGS11D/860B22	251	MINI/P60	49
LGS11D/860E27	251	MINI/P60	50
LPAR20DL	247	MINI/P60	265
LPAR20WW	247	MR16 5W DL	49
LPAR30DL	247	MR16 5W DL	50
LPAR30WW	247	MR16 5W DL	241
LPAR38DL	247	MR16 5W WW	49
LPAR38WW	247	MR16 5W WW	50

INDEX

MR16 5W WW	241	S9002WH	49
MR16/7W/DL	49	S9003CH	49
MR16/7W/DL	50	S9003GL	49
MR16/7W/DL	241	S9003SC	49
MR16/7W/WW	49	S9003SN	49
MR16/7W/WW	50	S9003WH	49
MR16/7W/WW	241	S9004CH	49
MR16DIM9W/DL	49	S9004SC	49
MR16DIM9W/DL	50	S9004SN	49
MR16DIM9W/DL	241	S9004WH	49
MR16DIM9W/WW	49	S9006DL	45
MR16DIM9W/WW	50	S9006WW	45
MR16DIM9W/WW	241	S9007DL	45
PLUTO 30W/12V	262	S9007WW	45
PLUTO 30W/24V	262	S9008DL	45
PLUTO 50W/12V	262	S9008WW	45
PLUTO 50W/24V	262	S9009DL	45
PLUTO 100W/12V	262	S9009WW	45
PLUTO 100W/24V	262	S9040 CW SN	3
PLUTO 200W/12V	262	S9040 CW WH	3
PLUTO 200W/24V	262	S9040 DL SN	3
PLUTO DIM350MA/12W	264	S9040 DL WH	3
PLUTO DIM350MA/18W	264	S9040SM/C CW WH	4
PLUTO DIM500MA/18W	264	S9040SM/C DL WH	4
PLUTO DIM700MA/18W	264	S9040SM/C WW WH	4
PLUTO EGL 12V/6W	262	S9040 WW SN	3
PLUTO EGL 12V/15W	262	S9040 WW WH	3
PLUTO EGL 24V/15W	262	S9041 CW BK	5
S306FM	113	S9041 CW SN	5
S306FMA	116	S9041 CW WH	5
S312FM	113	S9041 DL BK	5
S312FMA	116	S9041 DL SL	5
S312FMCR	117	S9041 DL SN	5
S606FM	113	S9041 DL WH	5
S606FMCR	117	S9041 S CW SN	6
S612FM	113	S9041 S CW WH	6
S9001CH	49	S9041 S DL SN	6
S9001GL	49	S9041 S DL WH	6
S9001SC	49	S9041SM/C CW WH	7
S9001SN	49	S9041SM/C DL WH	7
S9001WH	49	S9041SM/C WW WH	7
S9002CH	49	S9041 S WW SN	6
S9002GL	49	S9041 S WW WH	6
S9002SC	49	S9041 WW BK	5
S9002SN	49	S9041 WW SL	5

INDEX

S9041 WW SN	5	S9072DP WH	26
S9041 WW WH	5	S9072WP SL	26
S9045 DL SN	20	S9072WP WH	26
S9045 DL WH	20	S9073 CP WH	26
S9045SM/C DL WH	23	S9073 DP SL	26
S9045SM/C WW WH	23	S9073 DP WH	26
S9045 WW SN	20	S9073 WP SL	26
S9045 WW WH	20	S9073 WP WH	26
S9046 DL SN	21	S9074CP WH	28
S9046 DL WH	21	S9074DP WH	28
S9046SM/C DL WH	24	S9074WP WH	28
S9046SM/C WW WH	24	S9075CP WH	28
S9046 WW SN	21	S9075DP WH	28
S9046 WW WH	21	S9075WP WH	28
S9048 DL SN	22	S9076CP WH	28
S9048 DL WH	22	S9076DP WH	28
S9048SM/C DL WH	24	S9076WP WH	28
S9048SM/C WW WH	24	S9081 DP SLS	19
S9048 WW SN	22	S9083 DP SLS	19
S9048 WW WH	22	S9105DL/SN	77
S9049 DL WH	12	S9105DL SR/SN	77
S9049 WW WH	12	S9105DL SR/WH	77
S9053 DP	41	S9105DL ST/SN	77
S9053 DP	49	S9105DL ST/WH	77
S9053 DP	50	S9105DL/WH	77
S9053 WP	41	S9105WW/SN	77
S9053 WP	49	S9105WW SR/SN	77
S9053 WP	50	S9105WW SR/WH	77
S9064CW WH	13	S9105WW ST/SN	77
S9064DL WH	13	S9105WW ST/WH	77
S9064WW WH	13	S9105WW/WH	77
S9065CW WH	14	S9113SL	78
S9065DL WH	14	S9113WH	78
S9065WW WH	14	S9114SL	78
S9066CW WH	15	S9115SL	78
S9066DL WH	15	S9115WH	78
S9066WW WH	15	S9141CW/WH	8
S9071CP SL	26	S9141DL/WH	8
S9071CP WH	26	S9141SM/C CW WH	9
S9071DP SL	26	S9141SM/C DL WH	9
S9071DP WH	26	S9141SM/C WW WH	9
S9071WP SL	26	S9141WW/WH	8
S9071WP WH	26	S9145WW/WH	44
S9072CP WH	26	S9146WW/WH	44
S9072DP SL	26	S9311 SN	83

INDEX

S9311 WH	83	S9349WW	227
S9316 ALU	81	S9351CW	228
S9316 WH	81	S9351WW	228
S9317 ALU	81	S9352CW	228
S9317 WH	81	S9352WW	228
S9318 AS	82	S9353CW/BK	229
S9318 MW	82	S9353CW/CB	229
S9320	85	S9353WW/BK	229
S9321LV BU	177	S9353WW/CB	229
S9324 BU	177	S9354CW/BK	229
S9324G BU	177	S9354CW/CB	229
S9324G WH	177	S9354WW/BK	229
S9324 WH	177	S9354WW/CB	229
S9325 BU	178	S9355WW/BK	183
S9325G BU	178	S9355WW/WH	183
S9325G WH	178	S9356/160WW/WH	86
S9325 WH	178	S9356/610WW/WH	86
S9326 BU	178	S9401CH	50
S9326G BU	178	S9401GL	50
S9327	84	S9401SC	50
S9328	84	S9401SN	50
S9329BK	181	S9404SL	50
S9329SL	181	S9404SN	50
S9330BK	181	S9404WH	50
S9330SL	181	S9408SL	50
S9337	174	S9413BK	50
S9338/3W/30 DL	176	S9413CH	50
S9338/3W/30 WW	176	S9413GL	50
S9341CW	223	S9413SC	50
S9341WW	223	S9413WH	50
S9342CW	224	S9511/LED/SL	79
S9342WW	224	S9511/LED/WH	79
S9343CW	224	S9512/LED/SL	79
S9343WW	224	S9512/LED/WH	79
S9344CW	225	S9514 DL SL	29
S9344WW	225	S9514 DL WH	29
S9345CW	225	S9514 WW SL	29
S9345WW	225	S9514 WW WH	29
S9346CW	226	S9515 LED SN	80
S9346WW	226	S9515 LED WH	80
S9347CW	226	S9520/2X700 SL	38
S9347WW	226	S9520/2X700 WH	38
S9348CW	227	S9520/2X1700 SL	38
S9348WW	227	S9520/2X1700 WH	38
S9349CW	227	S9520/3X700 SL	38

INDEX

S9520/3X700 WH	38	S9656CW WH	36
S9520/3X1700 SL	38	S9656CW WH RG	36
S9520/3X1700 WH	38	S9656CW WH SQ	36
S9520/700 SL	38	S9656CW WH SQG	36
S9520/700 WH	38	S9656WW BK	36
S9520/1700 SL	38	S9656WW BK SQ	36
S9520/1700 WH	38	S9656WW WH	36
S9522 DL SL	30	S9656WW WH RG	36
S9522 DL WH	30	S9656WW WH SQ	36
S9522 WW SL	30	S9656WW WH SQG	36
S9522 WW WH	30	S9658CW BK	36
S9523 DL SL	31	S9658CW BK SQ	36
S9523 DL WH	31	S9658CW WH	36
S9523SM/C DL WH	32	S9658CW WH RG	36
S9523SM/C WW WH	32	S9658CW WH SQ	36
S9523 WW SL	31	S9658CW WH SQG	36
S9523 WW WH	31	S9658WW BK	36
S9530/2X1700 SL	38	S9658WW BK SQ	36
S9530/2X1700 WH	38	S9658WW WH	36
S9530/2X3500 SL	38	S9658WW WH RG	36
S9530/2X3500 WH	38	S9658WW WH SQ	36
S9530/3X1700 SL	38	S9658WW WH SQG	36
S9530/3X1700 WH	38	S9704/214 FRAME	114
S9530/3X3500 SL	38	S9704/228 FRAME	114
S9530/3X3500 WH	38	S9704/328 FRAME	114
S9530/1700 SL	38	S9704/414 FRAME	114
S9530/1700 WH	38	S9714/306 CW	110
S9530/3500 SL	38	S9714/306 DL	110
S9530/3500 WH	38	S9714/306EM	110
S9535 CW WH	33	S9714/306 WW	110
S9535 DL WH	33	S9714/312 CW	110
S9535 WW WH	33	S9714/312 DL	110
S9545CW/WH	34	S9714/312EM	110
S9545DL/WH	34	S9714/312 WW	110
S9545WW/WH	34	S9714/606 CW	110
S9653C/P SN	47	S9714/606 DL	110
S9653C/P WH	47	S9714/606EM	110
S9653C SN	47	S9714/606 WW	110
S9653C WH	47	S9714/612 CW	110
S9653P SN	47	S9714/612 DL	110
S9653P WH	47	S9714/612EM	110
S9653 SN	47	S9714/612 WW	110
S9653 WH	47	S9714HC/312CW	112
S9656CW BK	36	S9714HC/606CW	112
S9656CW BK SQ	36	S9714HC/612CW	112

INDEX

S9714HO/312TC	111	SE7009 BK	196
S9714HO/606TC	111	SE7009 SLS	196
S9714SP	115	SE7013 BK	170
S9724/306CW	119	SE7013 SLS	170
S9724/306DL	119	SE7016 BK	196
S9724/306WW	119	SE7016 SLS	196
S9724/312CW	119	SE7017 BK	196
S9724/312DL	119	SE7017 SLS	196
S9724/312WW	119	SE7018 BK	196
S9724/606CW	119	SE7018 SLS	196
S9724/606DL	119	SE7019 BK	196
S9724/606WW	119	SE7019 SLS	196
S9724/612CW	119	SE7031 BK	184
S9724/612DL	119	SE7031 SL	184
S9724/612WW	119	SE7033 BK	184
S9725/312CW	122	SE7051/65	198
S9725/606CW	122	SE7051/100	198
S9733/212CW	97	SE7053/65	198
S9733/212DL	97	SE7053/100	198
S9733L/212CW	99	SE7061/300 BK	190
S9733L/212DL	99	SE7061/300 CB	190
S9734/306L/CW	121	SE7061/300 LV BK	190
S9734/312L/CW	121	SE7061/300 LV CB	190
S9734/606L/CW	121	SE7061/500 BK	190
S9734/612L/CW	121	SE7061/500 CB	190
S9775CW	103	SE7061/500 LV BK	190
S9841SM	11	SE7061/500 LV CB	190
S9841WH	10	SE7061/800 BK	190
S9865WH	18	SE7061/800 CB	190
S9901	270	SE7061/800 LV BK	190
S9902F/120-S9053 DP	43	SE7061/800 LV CB	190
S9902F/120-S9053 WP	43	SE7062	192
S9903	270	SE7062/300 BK	193
S9913	271	SE7062/300 CB	193
S9922	270	SE7062/650 BK	193
SDA450	268	SE7062/650 CB	193
SDD350TCM	268	SE7071/15DL/BK	162
SDD350TCS	268	SE7071/15DL/SL	162
SDF30	268	SE7071/15DL/WH	162
SE7006 BK	196	SE7071/15WW/BK	162
SE7006 SLS	196	SE7071/15WW/SL	162
SE7007 BK	196	SE7071/15WW/WH	162
SE7007 SLS	196	SE7071/30DL/BK	162
SE7008 BK	196	SE7071/30DL/SL	162
SE7008 SLS	196	SE7071/30DL/WH	162

INDEX

SE7071/30WW/BK	162	SE7084L SL WW	220
SE7071/30WW/SL	162	SE7085	197
SE7071/30WW/WH	162	SE7086/55	197
SE7071/50DL/BK	162	SE7086/100	197
SE7071/50DL/SL	162	SE7087L	217
SE7071/50DL/WH	162	SE7088 BK	210
SE7071/50WW/BK	162	SE7088 CB	210
SE7071/50WW/SL	162	SE7089BK	211
SE7071/50WW/WH	162	SE7099/50DL/BK	231
SE7079/20 BK DL	230	SE7099/50DL/SL	231
SE7079/40 BK DL	230	SE7099/50WW/BK	231
SE7079/40 BK WW	230	SE7099/50WW/SL	231
SE7079/65 BK DL	230	SE7099/75DL/BK	231
SE7079/65 BK WW	230	SE7099/75DL/SL	231
SE7079/100 BK DL	230	SE7099/75WW/BK	231
SE7079/100 BK WW	230	SE7099/75WW/SL	231
SE7080/1 DL BK	165	SE7099/150DL/BK	232
SE7080/1 WW BK	165	SE7099/150DL/SL	232
SE7080/2 DL BK	165	SE7099/150WW/BK	232
SE7080/2 DL SL	165	SE7099/150WW/SL	232
SE7080/2 WW BK	165	SE7099/200DL/BK	232
SE7080/2 WW SL	165	SE7099/200DL/SL	232
SE7081L BK DL	218	SE7099/200WW/BK	232
SE7081L BK WW	218	SE7099/200WW/SL	232
SE7081L SL DL	218	SE7102 BK/LGLS	238
SE7081L SL WW	218	SE7102 SL/LGLS	238
SE7082L BK DL	218	SE7103BK/LGLS	237
SE7082L BK WW	218	SE7104BK/LGLS	237
SE7082L SL DL	218	SE7105BK/LGLS	237
SE7082L SL WW	218	SE7106BK/LGLS	237
SE7083L BK DL	220	SE7121BK GU10	186
SE7083L BK WW	220	SE7121SL GU10	186
SE7083L/EM/DL/BK	220	SE7121SLS GU10	186
SE7083L/EM/DL/SL	220	SE7122BK GU10	186
SE7083L/EM/WW/BK	220	SE7122SL GU10	186
SE7083L/EM/WW/SL	220	SE7122SLS GU10	186
SE7083L SL DL	220	SE7123BK GU10	186
SE7083L SL WW	220	SE7123SL GU10	186
SE7084L BK DL	220	SE7123SLS GU10	186
SE7084L BK WW	220	SE7128GU10	186
SE7084L/EM/DL/BK	220	SE7129GU10	186
SE7084L/EM/DL/SL	220	SE7130GU10	186
SE7084L/EM/WW/BK	220	SE7131BK GU10	189
SE7084L/EM/WW/SL	220	SE7131CB GU10	189
SE7084L SL DL	220	SE7132BK GU10	189

INDEX

SE7132CB GU10	189	SE7146CW/BK	207
SE7133BK GU10	185	SE7146CW/CB	207
SE7133SL GU10	185	SE7146WW/BK	207
SE7134BK GU10	185	SE7146WW/CB	207
SE7134SL GU10	185	SE7147CW/BK	208
SE7135CW/BK	202	SE7147CW/CB	208
SE7135CW/SL	202	SE7147WW/BK	208
SE7135WW/BK	202	SE7147WW/CB	208
SE7135WW/SL	202	SE7148CW/BK	209
SE7136CW/BK	202	SE7148CW/CB	209
SE7136CW/SL	202	SE7148NB/CW BK	209
SE7136WW/BK	202	SE7148NB/CW CB	209
SE7136WW/SL	202	SE7148NB/WW BK	209
SE7137CW/BK	202	SE7148NB/WW CB	209
SE7137CW/SL	202	SE7148WW/BK	209
SE7137WW/BK	202	SE7148WW/CB	209
SE7137WW/SL	202	SE7174/10DL/BK	164
SE7138CW	202	SE7174/10DL/SL	164
SE7138WW	202	SE7174/10WW/BK	164
SE7139CW	202	SE7174/10WW/SL	164
SE7139WW	202	SE7174/20DL/BK	164
SE7140CW/BK	204	SE7174/20DL/SL	164
SE7140CW/SL	204	SE7174/20WW/BK	164
SE7140WW/BK	204	SE7174/20WW/SL	164
SE7140WW/SL	204	SE7174/30DL/BK	164
SE7141CW/BK	204	SE7174/30DL/SL	164
SE7141CW/SL	204	SE7174/30WW/BK	164
SE7141WW/BK	204	SE7174/30WW/SL	164
SE7141WW/SL	204	SE7174/50DL/BK	164
SE7142CW/BK	204	SE7174/50DL/SL	164
SE7142CW/SL	204	SE7174/50WW/BK	164
SE7142WW/BK	204	SE7174/50WW/SL	164
SE7142WW/SL	204	SE7250 BK	172
SE7143CW/BK	205	SE7250 SL	172
SE7143CW/SL	205	SE7250 WH	172
SE7143WW/BK	205	SE7251 BK	172
SE7143WW/SL	205	SE7251 SL	172
SE7144CW/BK	205	SE7251 WH	172
SE7144CW/SL	205	SE7252 BK	172
SE7144WW/BK	205	SE7252 SL	172
SE7144WW/SL	205	SE7252 WH	172
SE7145CW/BK	206	SE7253 BK	171
SE7145CW/SL	206	SE7253 SL	171
SE7145WW/BK	206	SE7253 WH	171
SE7145WW/SL	206	SE7254 BK	171

INDEX

SE7254 SL	171	SL2109/40CW	58
SE7254 WH	171	SL2109/40DL	58
SE7255 BK	171	SL2109/40WW	58
SE7255 SL	171	SL3147/28CW	64
SE7255 WH	171	SL3147/35CW	64
SE7258 SN	182	SL3147/306 CW	100
SE7259 SL	182	SL3147/312 CW	100
SE7259 SN	182	SL7221GU AS	187
SE7260 SL	182	SL7221GU BK	187
SE7273 BK	170	SL7221GU SL	187
SE7273 WH	170	SL7222GU AS	187
SELK1500/SF	267	SL7222GU BK	187
SELK2500/SM	266	SL7222GU SL	187
SES7080/1 DL BK	166	SL7261 AS	175
SES7080/1 WW BK	166	SL7261 BK	175
SES7080/2 DL BK	166	SL7261 SL	175
SES7080/2 WW BK	166	SL7261 SLS	175
SES7090/2DL/BK	167	SL7262 BK	179
SES7090/2WW/BK	167	SL7262 SA	179
SGU9000LH	270	SL7262 SL	179
SHB14/120	233	SL7262 SLS	179
SHB14/120 MD	233	SL7263 BK	180
SHB14/120 PD	233	SL7263 SA	180
SHB14/200	234	SL7263 SL	180
SHB14/200 MD	234	SL7263 SLS	180
SHB14/300	234	SL7264/40-1 BK	175
SHB14/300 MD	234	SL7264/40-1 SL	175
SHB22/140	235	SL7264/40-1 SLS	175
SHB22/240	235	SL7264/40-2 BK	175
SHP100/60 BK	236	SL7264/40-2 SL	175
SHP100/60 CB	236	SL7264/40-2 SLS	175
SHP100/90 BK	236	SL7266WW/BK	174
SHP100/90 CB	236	SL7267 BK	179
SHP100/120 BK	236	SL7267 SA	179
SHP100/120 CB	236	SL7267 SL	179
SL2105/20DL	56	SL7267 SLS	179
SL2105/20WW	56	SL7268 BK	180
SL2105/30DL	56	SL7268 SA	180
SL2105/30WW	56	SL7268 SL	180
SL2105/40DL	56	SL7268 SLS	180
SL2105/40WW	56	SL7269DL BK	173
SL2107/30DL	59	SL7269DL WH	173
SL2107/30WW	59	SL7270DL BK	173
SL2108DL	58	SL7270DL WH	173
SL2108WW	58	SL9706/280CW/FP	102

INDEX

SL9706/280DL/FP	102	SLC21/WW	261
SL9706/280WW/FP	102	SLC30/CW	261
SL9706/540CW/FP	102	SLC30/DL	261
SL9706/540DL/FP	102	SLC30/WW	261
SL9706/540WW/FP	102	SLD2000CW	95
SL9706/840CW/FP	102	SLD4000CW	95
SL9706/840DL/FP	102	SLH100	270
SL9706/840WW/FP	102	SLT1000	151
SL9706/1140CW/FP	102	SLT2000	151
SL9706/1140DL/FP	102	SLT3000	151
SL9706/1140WW/FP	102	SLT4000	152
SL9706/1440CW/FP	102	SLT4050	152
SL9706/1440DL/FP	102	SLT5000	152
SL9706/1440WW/FP	102	SMS800	272
SL9707/60CW	105	SMS801WF	274
SL9707/60DL	105	SMS802WR	275
SL9707/60WW	105	SMS803CD	276
SL9707/120CW	105	SMS804CR	277
SL9707/120DL	105	SMS805CS	278
SL9707/120WW	105	SMS810	273
SL9709/60CW	106	SO2101/30 AB	60
SL9709/60DL	106	SO2101/30 CH	60
SL9709/60WW	106	SO2101/30 GD	60
SL9709/120CW	106	SO2101/30 LED	60
SL9709/120DL	106	SO2101/30 SC	60
SL9709/120WW	106	SO2101/30 WH	60
SL9712/40 BK	213	SO2101/40 AB	60
SL9712/40 SL	213	SO2101/40 CH	60
SL9712/40 WH	213	SO2101/40 GD	60
SL9712 BL	212	SO2101/40 LED	60
SL9712 CH	212	SO2101/40 SC	60
SL9712 SL	212	SO2101/40 WH	60
SL9712 WH	212	SO2107	59
SL9717WH	214	SO3103/30 CH	61
SL9718WH	215	SO3103/30 GD	61
SL9719RD	216	SO3103/30 LED	61
SL9719SQ	216	SO3103/30 SC	61
SL9721/20W DL	221	SO3103/40 CH	61
SL9721/20W WW	221	SO3103/40 GD	61
SL9721/35W DL	221	SO3103/40 LED	61
SL9721/35W WW	221	SO3103/40 SC	61
SLA7102BK	238	SO3109/30	62
SLA7102SL	238	SO3109/30 LED	62
SLC21/CW	261	SO3109/40	62
SLC21/DL	261	SO3109/40 LED	62

INDEX

SO3160/30	63	STB/106 WW	90
SO3160/45	63	STB/112 CW	90
SO3700/30L CW	53	STB/112 DL	90
SO3700/30L DL	53	STB/112 WW	90
SO3700/30L WW	53	STB/206 CW	90
SO3700/40L CW	53	STB/206 DL	90
SO3700/40L DL	53	STB/206EM2500	90
SO3700/40L WW	53	STB/206 WW	90
SO3701/30L CW	55	STB/212 CW	90
SO3701/30L DL	55	STB/212 DL	90
SO3701/30L WW	55	STB/212EM2500	90
SO3701/40L CW	55	STB/212 WW	90
SO3701/40L DL	55	STD/106 CW	92
SO3701/40L WW	55	STD/106 DL	92
SO3800/40 CW	57	STD/106 WW	92
SO3800/40 DL	57	STD/112 CW	92
SO3800/40 WW	57	STD/112 DL	92
SO3800EM CW	57	STD/112 WW	92
SO3800EM DL	57	STD/206 CW	92
SO3800EM WW	57	STD/206 DL	92
SPK1000 DL BK	168	STD/206EM2500	92
SPK2000 DL BK	168	STD/206 WW	92
SPL015	65	STD/212 CW	92
SPL016	66	STD/212 DL	92
SPL017	67	STD/212EM2500	92
SPL018	68	STD/212 WW	92
SPL019	69	STG/106 CW	94
SPL3100/64	71	STG/106 DL	94
SPL3100/84	71	STG/106 WW	94
SPL3200/2R	73	STG/112 CW	94
SPL3200/3R	73	STG/112 DL	94
SPL3200/46	73	STG/112 WW	94
SPL3200/60	73	STG/206 CW	94
SPL3200/81	73	STG/206 DL	94
SPSK1000 DL BK	169	STG/206EM2500	94
SPSK2000 DL BK	169	STG/206 WW	94
SSI1512	271	STG/212 CW	94
SSY1512	271	STG/212 DL	94
ST105	266	STG/212EM2500	94
ST150	266	STG/212 WW	94
ST200	266	STR3/4863GU BK	140
ST300	266	STR3/4863GU WH	140
ST400	266	STR4800/1 BK	125
STB/106 CW	90	STR4800/1 SL	125
STB/106 DL	90	STR4800/1 WH	125

INDEX

STR4800/2 BK	125	STR4882/36 BK WW	136
STR4800/2 SL	125	STR4882/36 WH WW	136
STR4800/2 WH	125	STR4883WW/BK	137
STR4801 BK	125	STR4883WW/WH	137
STR4801 SL	125	STR4886WW/BK	139
STR4801 WH	125	STR4886WW/WH	139
STR4802 BK	125	STR4890/1 BK	133
STR4802 SL	125	STR4890/1 WH	133
STR4802 WH	125	STR4890/2 BK	133
STR4803 BK	125	STR4890/2 WH	133
STR4803 SL	125	STR4891 BK	133
STR4803 WH	125	STR4891 WH	133
STR4804 BK	125	STR4892 BK	133
STR4804 SL	125	STR4892 WH	133
STR4804 WH	125	STR4893 BK	133
STR4805 BK	125	STR4893 WH	133
STR4805 SL	125	STR4894 BK	133
STR4805 WH	125	STR4894 WH	133
STR4806 BK	125	STR4895 BK	133
STR4806 SL	125	STR4895 WH	133
STR4806 WH	125	STR4896 BK	133
STR4808 BK	125	STR4896 WH	133
STR4808 SL	125	STR4897 BK	133
STR4808 WH	125	STR4897 WH	133
STR4855L BK	127	STR4898 BK	133
STR4855L SL	127	STR4898 WH	133
STR4855L WH	127	STR4899/1 BK	133
STR4856L BK	127	STR4899/1 WH	133
STR4856L SL	127	STR4899/2 BK	133
STR4856L WH	127	STR4899/2 WH	133
STR4861WW/BK	130	STR4899/3 BK	133
STR4861WW/WH	130	STR4899/3 WH	133
STR4863GU BK	129	SW2101 AB	60
STR4863GU WH	129	SW2101 CH	60
STR4863LV WH	128	SW2101 GD	60
STR4866CW/BK	131	SW2101 SC	60
STR4866CW/WH	131	SW2101 WH	60
STR4881/30BK CW 24 DG	135	SW3103 CH	61
STR4881/30BK WW 24 DG	135	SW3103 GD	61
STR4881/30WH CW 24 DG	135	SW3103 SC	61
STR4881/30WH WW 24 DG	135	SW3109	62
STR4881/50BK CW 24 DG	135		
STR4881/50BK WW 24 DG	135		
STR4881/50WH CW 24 DG	135		
STR4881/50WH WW 24 DG	135		



www.sal.net.au

NSW

HEAD OFFICE

40 Biloela Street
Villawood NSW 2163
P: (02) 9723 3099
F: (02) 9724 1899

VIC

46-48 Keys Road
Moorabbin VIC 3189
P: (03) 9532 3168
F: (03) 9532 1838

QLD

13/258 Musgrave Road
Coopers Plains QLD 4108
P: (07) 3276 8897
F: (07) 3277 8817

WA

20 Trade Road
Malaga WA 6090
P: (08) 9248 7458
F: (08) 9249 8848

