

Lighting Inspirations

By - Lode International - Circa 1965 -

2014 - 2015 Catalogue

*" Be Inspired And
Discover The Difference "*

- Styles -

Retro - Gothic - Rococo - Modern

Art Deco Nouveaux - Arts & Crafts - Grand American

Italian Neo Classics - American Hampton Style

French Provincial - Contemporary Classics - Tuscan

Crystal Chandeliers - Industrial



Lighting Inspirations

By - Lode International - Circa 1965 -



Globe Required

Stockton Industry Range

B-15 B-22 E-14 E-27

STOCKTON WALL SCNCE 1/LT CHROME

FRAME SIZE
H - 21cm W - 31cm

STOCKTON CHAIN LARGE 1/LT CHROME

FRAME SIZE WITH OUT CHAIN
H - 33cm W - 43cm

** ALL * CHAIN PENDANTS ARE SUPPLIED WITH 1 METER CHAIN*

STOCKTON CHAIN MEDIUM 1/LT CHROME

FRAME SIZE WITH OUT CHAIN
H - 26cm W - 31cm

STOCKTON CHAIN SMALL 1/LT CHROME

FRAME SIZE WITH OUT CHAIN
H - 21cm W - 26cm

STOCKTON SEMI FLUSH 2/LT CHROME

FRAME SIZE
H - 33cm W - 32cm

NEW PRODUCT

STOCKTON OYSTER 2/LT CHROME

FRAME SIZE
H - 23cm W - 35cm

STOCKTON C.T.C MEDIUM 1/LT CHROME

FRAME SIZE
H - 28cm W - 31cm

NEW PRODUCT

STOCKTON C.T.C SMALL 1/LT CHROME

FRAME SIZE
H - 23cm W - 26cm

STOCKTON MEDIUM STANDARD 1/2" ROD PND CHROME

FRAME SIZE
H - 72cm W - 31cm

NOTE - ROD PENDANTS SUPPLIED WITH 1/2 METER ROD DROP. 1/2 METER EXTENSIONS AVAILABLE

STOCKTON LARGE STANDARD 3/4" ROD PND CHROME

FRAME SIZE
H - 79cm W - 43cm

STOCKTON SMALL STANDARD 1/2" ROD PND CHROME

FRAME SIZE
H - 68cm W - 26cm

Lighting Inspirations

By - Lode International - Circa 1965 -



Globe Required

B-15 B-22 E-14 E-27

Willhelm Industry Range



WILLHELM
SINGLE PND
1/LT
CHROME

FRAME SIZE
WITH OUT CHAIN
H - 38cm
W - 32cm

E-27

FEATURING
THICK
HALOPHANE
GLASSWARE

NEW
PRODUCT



WILLHELM
OYSTER
2/LT
CHROME

FRAME SIZE
H - 22cm
W - 32cm

E-27

FEATURING
THICK
HALOPHANE
GLASSWARE



WILLHELM
OYSTER
2/LT
BRONZE

FRAME SIZE
H - 22cm
W - 32cm

E-27

NEW
PRODUCT

* ALL *
CHAIN
PENDANTS
ARE
SUPPLIED
WITH
1
METER
CHAIN



WILLHELM
SINGLE PND
1/LT
BRONZE

FRAME SIZE
WITH OUT CHAIN
H - 38cm
W - 32cm

E-27



Lighting Inspirations

By - *Lode International* - Circa 1965 -



Globe Required

(B-15) (B-22) (E-14) (E-27)

Maine & Delaware Range

MAINE
1/LT C.T.C
CHROME

FRAME SIZE
H - 54cm
W - 31cm

(E27)



DELAWARE
1/LT C.T.C
CHROME

FRAME SIZE
H - 46cm
W - 38cm

(E27)

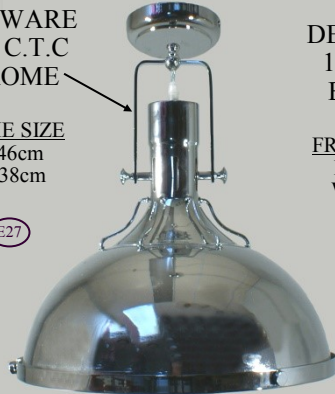

DELAWARE
1/LT C.T.C
BRONZE

FRAME SIZE
H - 46cm
W - 38cm

(E27)



MAINE
1/LT C.T.C
BRONZE

FRAME SIZE
H - 54cm
W - 31cm

(E27)



**BOTTOM VIEW OF
FROST GLASS DIFFUSER**

MAINE
1/LT PND
CHROME

150mm
305mm
305mm
305mm
305mm

1165mm

(E27)

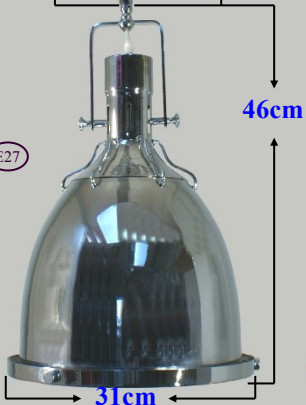

DELAWARE
1/LT PND
CHROME

150mm
305mm
305mm
305mm
305mm

1165mm

(E27)

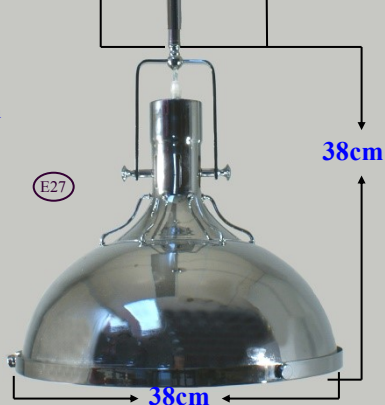

**THE
LATEST
INDUSTRIAL
LOOK**

DELAWARE
1/LT PND
BRONZE

(E27)

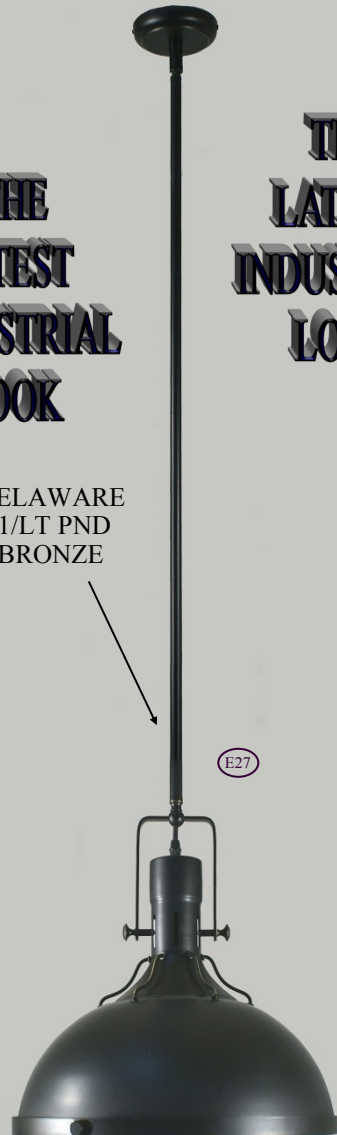

**THE
LATEST
INDUSTRIAL
LOOK**

MAINE
1/LT PND
BRONZE

(E27)

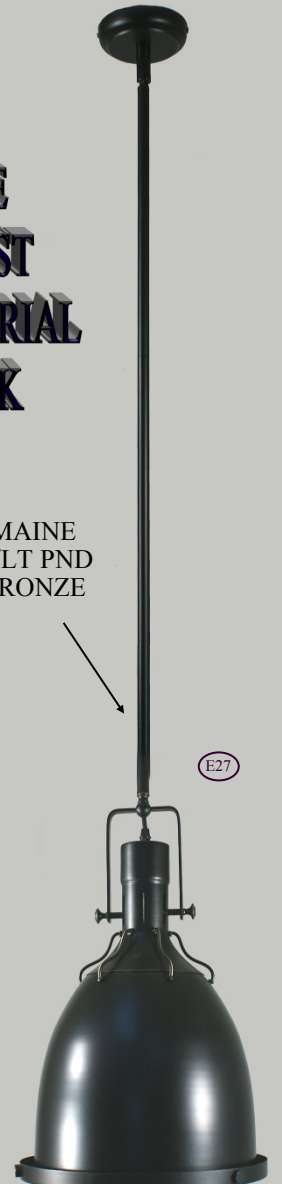

Lighting Inspirations

By - Lode International - Circa 1965 -



Globe Required

B-15 B-22 E-14 E-27

Washington Range

**NEW
PRODUCT**

WASHINGTON
SMALL
1/LT PND
CHROME

WASHINGTON
LARGE
1/LT PND
CHROME

**BOTTOM VIEW OF
FROST GLASS DIFFUSER**



**NEW
PRODUCT**

WASHINGTON
SMALL
1/LT PND
BRONZE

WASHINGTON
LARGE
1/LT PND
BRONZE

**THE
LATEST
INDUSTRIAL
LOOK**

Lighting Inspirations

By - *Lode International* - Circa 1965 -



Globe Required

B-15 B-22 E-14 E-27

Paramount Range

PARAMOUNT
1/LT PND
4 1/4" FITTER
BRONZE
WITH-
SPHERE
12" CLEAR

FRAME SIZE
WITH OUT CHAIN
H - 51cm
W - 30cm



PARAMOUNT
1/LT PND
4 1/4" FITTER
BRONZE
WITH-
ST KILDA 8" CLEAR

FRAME SIZE
WITH OUT CHAIN
H - 41cm
W - 21cm



SPHERE 12" - 10" - 8" OPAL MATT & GLOSS

*** SUGGESTED
GLASSWARE**

PARAMOUNT
1/LT PND
4 1/4" FITTER
CHROME
WITH-
SWINDON
LARGE

FRAME SIZE
WITH OUT CHAIN
H - 51cm
W - 28cm



PARAMOUNT
1/LT PND
4 1/4" FITTER
CHROME
WITH-
SPHERE
8" CLEAR

FRAME SIZE
WITH OUT CHAIN
H - 41cm
W - 20cm



DOMEC CLEAR



SPHERE 10" CLEAR



DOMEC OPAL GLOSS



CHICAGO



VICTORIAN SCHOOLHOUSE 12"

Lighting Inspirations

By - Lode International - Circa 1965 -



Globe Required

Bastia & Eiffel Range

B-15 B-22 E-14 E-27



BASTIA
SMALL PND
OLD NICKEL
FRAME SIZE
WITH OUT FLEX
H - 21cm
W - 30cm

**NEW
PRODUCT**

E-27



BASTIA
SMALL PND
BRONZE
FRAME SIZE
WITH OUT FLEX
H - 21cm
W - 30cm

E-27



BASTIA
SMALL PND
OLD BRASS
FRAME SIZE
WITH OUT FLEX
H - 21cm
W - 30cm

E-27

**CLASSIC
INDUSTRIAL
METAL
SHADES**



BASTIA
LARGE PND
OLD NICKEL
FRAME SIZE
WITH OUT FLEX
H - 27cm
W - 41cm

**NEW
PRODUCT**

E-27



BASTIA
LARGE PND
BRONZE
FRAME SIZE
WITH OUT FLEX
H - 27cm
W - 41cm

E-27

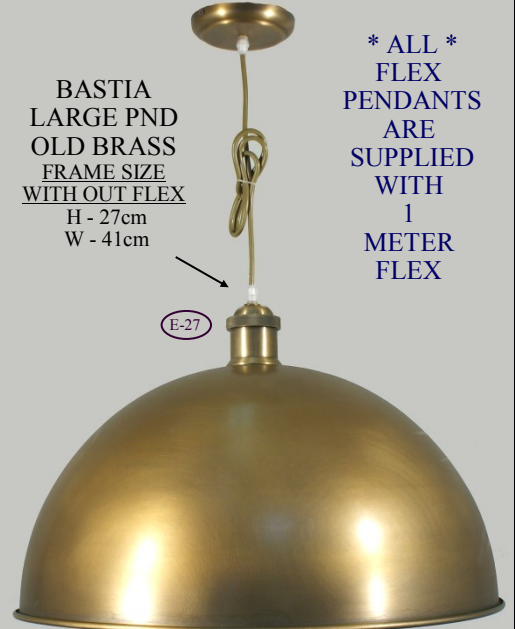

BASTIA
LARGE PND
OLD BRASS
FRAME SIZE
WITH OUT FLEX
H - 27cm
W - 41cm

E-27

*** ALL *
FLEX
PENDANTS
ARE
SUPPLIED
WITH
1
METER
FLEX**

**CLASSIC
INDUSTRIAL
METAL
SHADES**



EIFFEL
PENDANT
OLD NICKEL
FRAME SIZE
WITH OUT FLEX
H - 12cm
W - 34cm

E-27



EIFFEL
PENDANT
BRONZE
FRAME SIZE
WITH OUT FLEX
H - 12cm
W - 34cm

E-27

**NEW
PRODUCT**



EIFFEL
PENDANT
OLD BRASS
FRAME SIZE
WITH OUT FLEX
H - 12cm
W - 34cm

E-27

*** ALL *
FLEX
PENDANTS
ARE
SUPPLIED
WITH
1
METER
FLEX**

Lighting Inspirations

By - Lode International - Circa 1965 -



Globe Required

Studio Metal Shade Range

(B-15) (B-22) (E-14) (E-27)

NOTE - ALL CHAIN & CLOTH CORD SUSP SETS SUPPLIED AS A 1MT DROP.

STUDIO SMALL SHADE BLACK GLOSS WITH CAGE ON INDUSTRIAL GAS BLACK CLOTH CORD SUSP CHROME

STUDIO LARGE SHADE BLACK MATT WITH CAGE ON INDUSTRIAL GAS BLACK CLOTH CORD SUSP CHROME

STUDIO LARGE SHADE RED GLOSS WITH CAGE ON SLIDING CANOPY RED CLOTH CORD SUSP CHROME

STUDIO SMALL SHADE RED GLOSS WITH CAGE ON SLIDING CANOPY RED CLOTH CORD SUSP CHROME

STUDIO LARGE SHADE RED GLOSS ON SLIDING CANOPY RED CLOTH CORD SUSP CHROME

STUDIO SMALL SHADE RED GLOSS ON SLIDING CANOPY RED CLOTH CORD SUSP CHROME

STUDIO LARGE SHADE BLACK GLOSS ON SLIDING CANOPY BLACK CLOTH CORD SUSP CHROME

STUDIO SMALL SHADE BLACK GLOSS ON SLIDING CANOPY BLACK CLOTH CORD SUSP CHROME

7 CLOTH CORD COLORS AVAILABLE

- BLACK
- BLK/WHT
- RED
- YELLOW
- PURPLE
- WHITE
- BROWN

NOTE - ALL CHAIN & CLOTH CORD SUSP SETS SUPPLIED AS A 1MT DROP.

STUDIO LARGE & SMALL SHADE SILVER WITH CAGE ON SLIDING CANOPY BLK/WHT CLOTH CORD SUSP CHROME

STUDIO LARGE & SMALL SHADE SILVER ON SLIDING CANOPY BLK/WHT CLOTH CORD SUSP CHROME

STUDIO LARGE & SMALL SHADE BLACK MATT WITH CAGE ON SLIDING CANOPY BLACK CLOTH CORD SUSP CHROME

STUDIO LARGE & SMALL SHADE WHITE GLOSS WITH CAGE ON SLIDING CANOPY WHITE CLOTH CORD SUSP CHROME

STUDIO LARGE & SMALL SHADE BLACK GLOSS ON SLIDING CANOPY BLACK CLOTH CORD SUSP CHROME

THE LATEST INDUSTRIAL LOOK

B-22 LAMP HOLDER FITTED ON REQUEST

STUDIO LARGE SHADE RED GLOSS WITH CAGE ON SLIDING CANOPY RED CLOTH CORD SUSP CHROME

STUDIO SMALL SHADE RED GLOSS WITH CAGE ON SLIDING CANOPY RED CLOTH CORD SUSP CHROME

STUDIO LARGE SHADE RED GLOSS ON SLIDING CANOPY RED CLOTH CORD SUSP CHROME

STUDIO SMALL SHADE RED GLOSS ON SLIDING CANOPY RED CLOTH CORD SUSP CHROME

NOTE - ALL CHAIN & CLOTH CORD SUSP SETS SUPPLIED AS A 1MT DROP.

STUDIO LARGE & SMALL SHADE WHITE GLOSS WITH CAGE ON SLIDING CANOPY WHITE CLOTH CORD SUSP CHROME

STUDIO LARGE & SMALL SHADE WHITE GLOSS ON SLIDING CANOPY WHITE CLOTH CORD SUSP CHROME

STUDIO LARGE & SMALL SHADE BLACK GLOSS ON SLIDING CANOPY BLACK CLOTH CORD SUSP CHROME

STUDIO LARGE & SMALL SHADE BLACK GLOSS ON SLIDING CANOPY BLACK CLOTH CORD SUSP CHROME

STUDIO LARGE & SMALL SHADE BLACK GLOSS ON SLIDING CANOPY BLACK CLOTH CORD SUSP CHROME

STUDIO LARGE SHADE RED GLOSS WITH CAGE ON SLIDING CANOPY RED CLOTH CORD SUSP CHROME

STUDIO SMALL SHADE RED GLOSS WITH CAGE ON SLIDING CANOPY RED CLOTH CORD SUSP CHROME

STUDIO LARGE SHADE RED GLOSS ON SLIDING CANOPY RED CLOTH CORD SUSP CHROME

STUDIO SMALL SHADE RED GLOSS ON SLIDING CANOPY RED CLOTH CORD SUSP CHROME

STUDIO LARGE & SMALL SHADE BLACK GLOSS ON SLIDING CANOPY BLACK CLOTH CORD SUSP CHROME

STUDIO LARGE & SMALL SHADE BLACK GLOSS ON SLIDING CANOPY BLACK CLOTH CORD SUSP CHROME

STUDIO LARGE & SMALL SHADE BLACK GLOSS ON SLIDING CANOPY BLACK CLOTH CORD SUSP CHROME

STUDIO LARGE & SMALL SHADE BLACK GLOSS ON SLIDING CANOPY BLACK CLOTH CORD SUSP CHROME

STUDIO LARGE SHADE RED GLOSS WITH CAGE ON SLIDING CANOPY RED CLOTH CORD SUSP CHROME

STUDIO SMALL SHADE RED GLOSS WITH CAGE ON SLIDING CANOPY RED CLOTH CORD SUSP CHROME

STUDIO LARGE SHADE RED GLOSS ON SLIDING CANOPY RED CLOTH CORD SUSP CHROME

STUDIO SMALL SHADE RED GLOSS ON SLIDING CANOPY RED CLOTH CORD SUSP CHROME

STUDIO LARGE & SMALL SHADE BLACK GLOSS ON SLIDING CANOPY BLACK CLOTH CORD SUSP CHROME

STUDIO LARGE & SMALL SHADE BLACK GLOSS ON SLIDING CANOPY BLACK CLOTH CORD SUSP CHROME

STUDIO LARGE & SMALL SHADE BLACK GLOSS ON SLIDING CANOPY BLACK CLOTH CORD SUSP CHROME

STUDIO LARGE & SMALL SHADE BLACK GLOSS ON SLIDING CANOPY BLACK CLOTH CORD SUSP CHROME

THE LATEST INDUSTRIAL LOOK

STUDIO LARGE SHADE RED GLOSS WITH CAGE ON SLIDING CANOPY RED CLOTH CORD SUSP CHROME
SHADE SIZE
W - 425mm
H - 360mm

STUDIO SMALL SHADE RED GLOSS WITH CAGE ON SLIDING CANOPY RED CLOTH CORD SUSP CHROME
SHADE SIZE
W - 320mm
H - 290mm

STUDIO LARGE SHADE RED GLOSS ON SLIDING CANOPY RED CLOTH CORD SUSP CHROME
SHADE SIZE
W - 410mm
H - 295mm

STUDIO SMALL SHADE RED GLOSS ON SLIDING CANOPY RED CLOTH CORD SUSP CHROME
SHADE SIZE
W - 305mm
H - 230mm

NOTE - ALL CHAIN & CLOTH CORD SUSP SETS SUPPLIED AS A 1MT DROP.

STUDIO LARGE & SMALL SHADE WHITE GLOSS WITH CAGE ON SLIDING CANOPY WHITE CLOTH CORD SUSP CHROME

STUDIO LARGE & SMALL SHADE WHITE GLOSS ON SLIDING CANOPY WHITE CLOTH CORD SUSP CHROME

STUDIO LARGE & SMALL SHADE BLACK GLOSS ON SLIDING CANOPY BLACK CLOTH CORD SUSP CHROME

STUDIO LARGE & SMALL SHADE BLACK GLOSS ON SLIDING CANOPY BLACK CLOTH CORD SUSP CHROME

Lighting Inspirations

By - Lode International - Circa 1965 -



Globe Required

Storeroom Metal Shade Range

B-15 B-22 E-14 E-27

STOREROOM
SMALL
SHADE
BLACK
GLOSS
WITH CAGE
ON
INDUSTRIAL
GAS
BLACK CLOTH
CORD SUSP
CHROME

NOTE -
ALL
CHAIN
&
CLOTH
CORD
SUSP
SETS
SUPPLIED
AS
A
1MT
DROP.

7
CLOTH
CORD
COLORS
AVAILABLE

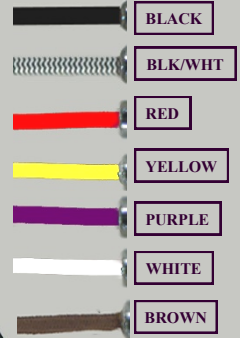

STOREROOM
LARGE
SHADE
BLACK
MATT
WITH CAGE
ON
INDUSTRIAL
GAS
BLACK CLOTH
CORD SUSP
CHROME

NOTE -
ALL
CHAIN
&
CLOTH
CORD
SUSP
SETS
SUPPLIED
AS
A
1MT
DROP.

STOREROOM
LARGE
&
SMALL SHADE
SILVER
WITH CAGE
ON
SLIDING
CANOPY
BLK/WHT
CLOTH
CORD SUSP
CHROME

STOREROOM
LARGE
&
SMALL SHADE
SILVER
ON
SLIDING
CANOPY
BLK/WHT
CLOTH
CORD SUSP
CHROME

THE LATEST INDUSTRIAL LOOK

STOREROOM
LARGE
&
SMALL SHADE
BLACK MATT
ON
SLIDING
CANOPY
BLACK CLOTH
CORD SUSP
CHROME

STOREROOM
LARGE
&
SMALL SHADE
BLACK MATT
WITH CAGE
ON
SLIDING
CANOPY
BLACK CLOTH
CORD SUSP
CHROME

B-22
LAMP HOLDER
FITTED ON
REQUEST

NOTE -
ALL
CHAIN
&
CLOTH
CORD
SUSP
SETS
SUPPLIED
AS
A
1MT
DROP.

STOREROOM
LARGE
&
SMALL SHADE
WHITE GLOSS
WITH CAGE
ON
SLIDING
CANOPY
WHITE CLOTH
CORD SUSP
CHROME

STOREROOM
LARGE
&
SMALL SHADE
WHITE GLOSS
ON
SLIDING
CANOPY
WHITE CLOTH
CORD SUSP
CHROME

STOREROOM
LARGE
SHADE
RED GLOSS
WITH CAGE
ON
SLIDING
CANOPY
RED CLOTH
CORD SUSP
CHROME
SHADE SIZE
W - 425mm
H - 235mm

STOREROOM
SMALL
SHADE
RED GLOSS
WITH CAGE
ON
SLIDING
CANOPY
RED CLOTH
CORD SUSP
CHROME
SHADE SIZE
W - 320mm
H - 215mm

STOREROOM
LARGE
SHADE
RED GLOSS
ON
SLIDING
CANOPY
RED CLOTH
CORD SUSP
CHROME
SHADE SIZE
W - 405mm
H - 180mm

STOREROOM
SMALL
SHADE
RED GLOSS
ON
SLIDING
CANOPY
RED CLOTH
CORD SUSP
CHROME
SHADE SIZE
W - 305mm
H - 160mm

STOREROOM
LARGE
&
SMALL SHADE
BLACK GLOSS
ON
SLIDING
CANOPY
BLACK CLOTH
CORD SUSP
CHROME

STOREROOM
LARGE
&
SMALL SHADE
BLACK GLOSS
WITH CAGE
ON
SLIDING
CANOPY
BLACK CLOTH
CORD SUSP
CHROME



Lighting Inspirations

By - *Lode International* - Circa 1965 -



Globe Required

Warehouse Metal Shade Range

(B-15) (B-22) (E-14) (E-27)

WAREHOUSE METAL COLOR CHART



BATTEN FIX
WAREHOUSE 300mm- 7 COLORS

CLOTH BLACK CORD SUSP CHROME W- WAREHOUSE 300mm BLACK

CLOTH BLACK CORD SUSP CHROME W- WAREHOUSE 420mm BLACK

NOTE - ALL CLOTH CORD SETS SUPPLIED AS A 1MT DROP.

CLOTH WHT/BLK CORD SUSP CHROME W- WAREHOUSE 300mm BLACK

CLOTH WHT/BLK CORD SUSP CHROME W- WAREHOUSE 420mm BLACK

CLOTH RED CORD SUSP CHROME W- WAREHOUSE 300mm BLACK

CLOTH RED CORD SUSP CHROME W- WAREHOUSE 420mm BLACK

CLOTH YELLOW CORD SUSP CHROME W- WAREHOUSE 300mm BLACK

CLOTH YELLOW CORD SUSP CHROME W- WAREHOUSE 420mm BLACK



NOTE - ALL CLOTH CORD SETS SUPPLIED AS A 1MT DROP.

CLOTH BROWN CORD SUSP CHROME W- WAREHOUSE 300mm BLACK

CLOTH BROWN CORD SUSP CHROME W- WAREHOUSE 420mm BLACK

CLOTH PURPLE CORD SUSP CHROME W- WAREHOUSE 300mm BLACK

CLOTH PURPLE CORD SUSP CHROME W- WAREHOUSE 420mm BLACK

CLOTH WHITE CORD SUSP CHROME W- WAREHOUSE 300mm BLACK

CLOTH WHITE CORD SUSP CHROME W- WAREHOUSE 420mm BLACK

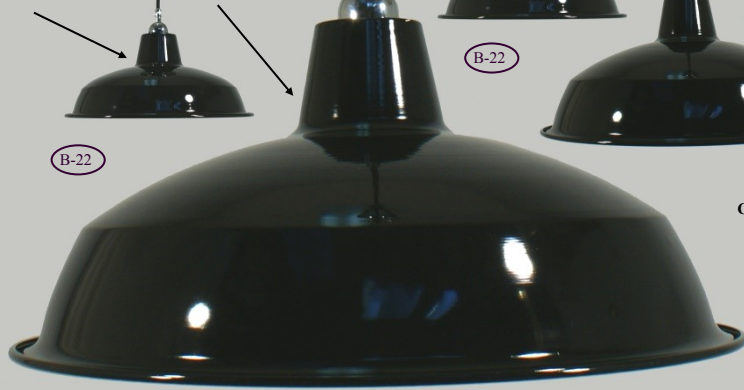

NOTE - CLOTH - FLEX & CHAIN SUSPENSION SUPPLIED AS A 1MT DROP.

7 CLOTH CORD COLORS AVAILABLE

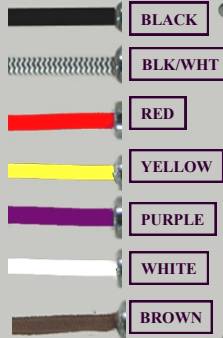

CHAIN BROWN CLOTH SUSP CHR W- WAREHOUSE 420mm SILVER

H-125cm W-42cm



INDUSTRIAL GAS CHAIN CORD BLACK CLOTH SUSP CHROME W- WAREHOUSE 420mm BLACK

H-125cm W-42cm



E-27 LAMP HOLDER FITTED ON REQUEST

TUSCANY CORD BROWN CLOTH SUSP CHROME W- WAREHOUSE 420mm BLACK

H-125cm W-42cm



SPECIAL TUSCANY KNOT

FLEX WHITE SUSP CHROME W- WAREHOUSE 420mm WHITE

H-125cm W-42cm



4 FLEX COLORS AVAILABLE



CHAIN SAW TOOTH BROWN CLOTH SUSP CHR W- WAREHOUSE 420mm BLUE

H-125cm W-42cm



NOTE - FLEX & CHAIN SUSPENSION SUPPLIED AS A 1MT DROP.

THE LATEST INDUSTRIAL LOOK

Lighting Inspirations

By - *Lode International* - Circa 1965 -



Globe Required

Industrial Metal Shade Range

B-15 B-22 E-14 E-27

STOREROOM LARGE WHITE SHADE WITH CAGE ON SLIDING CANOPY BUSTER WHITE CLOTH SUSP CHROME (B-22)

STOREROOM SMALL & LARGE SHADE WITH CAGE IN BLACK GLOSS
 - SILVER
 - RED
 - WHITE
 - BLACK MATT

STOREROOM SMALL BLACK MATT SHADE WITH CAGE ON SLIDING CANOPY BUSTER BLACK CLOTH SUSP CHROME (B-22)

STOREROOM LARGE SILVER SHADE ON SLIDING CANOPY BUSTER BLACK WHITE CLOTH SUSP CHROME (B-22)

STOREROOM SMALL & LARGE SHADE IN BLACK GLOSS
 - SILVER
 - RED
 - WHITE
 - BLACK MATT

STOREROOM SMALL RED SHADE ON SLIDING CANOPY BUSTER RED CLOTH SUSP CHROME (B-22)

STUDIO LARGE BLACK GLOSS SHADE ON BUSTER SLIDING CANOPY BLACK CLOTH CORD SUSP CHROME (B-22)

STUDIO SMALL WHITE SHADE ON BUSTER SLIDING CANOPY WHITE CLOTH CORD SUSP CHROME (B-22)

STUDIO LARGE RED SHADE WITH CAGE ON BUSTER SLIDING CANOPY RED CLOTH CORD SUSP CHROME (B-22)

STUDIO SMALL SILVER SHADE WITH CAGE ON BUSTER SLIDING CANOPY BLACK WHITE CLOTH CORD SUSP CHROME (B-22)

NEW PRODUCT

NEW PRODUCT

WAREHOUSE LARGE BLACK SHADE ON BUSTER STANDARD BLACK CLOTH CORD SUSP CHROME (B-22)

WAREHOUSE LRG & SML SHADE IN - BURGUNDY - SILVER

WAREHOUSE LRG & SML SHADE IN - GREEN - MAGNOLIA

WAREHOUSE LRG & SML SHADE IN - BLUE - WHITE (B-22)

WAREHOUSE SMALL BLACK SHADE ON BUSTER STANDARD BLACK WHITE CLOTH CORD SUSP CHROME (B-22)

EDWARDIAN 390mm SILVER SHADE ON BUSTER SLIDING CANOPY BLACK CLOTH CORD SUSP CHROME (B-22)

EDWARDIAN SHADE SIZE AVAILABLE IN - 390mm & 320mm & 250mm

EDWARDIAN COLORS AVAILABLE IN - BURGUNDY & BLACK & WHITE & MAGNOLIA & GREEN & SILVER & BLUE (B-22)

EDWARDIAN 320mm BLUE SHADE ON BUSTER SLIDING CANOPY BLACK CLOTH CORD SUSP CHROME (B-22)

- CLOTH CORD COLORS IN - BLACK-BLK/WHT-PURPLE-WHITE-RED-YELLOW-BROWN

Lighting Inspirations

By - *Lode International* - Circa 1965 -



Globe Required

Buster Industrial Suspension Range

B-15 B-22 E-14 E-27

NEW PRODUCT

CLOTH CORD OPTIONS

B-22

BUSTER STANDARD RECESSED LAMP HOLDER CORD BLACK CLOTH SUSPENSION CHROME

DISPLAYED WITH ROUND CARBON FILAMENT GLOBE

B-22

BUSTER STANDARD RECESSED LAMP HOLDER CORD BLACK & WHITE CLOTH SUSPENSION PATINA BLACK

DISPLAYED WITH CARBON FILAMENT GLOBE

B-22

BUSTER STANDARD RECESSED LAMP HOLDER CORD BLACK CLOTH SUSPENSION CHROME

* ALSO AVAILABLE IN BRONZE

B-22

BUSTER STANDARD EXTENDED LAMP HOLDER CORD BLACK CLOTH SUSPENSION CHROME

* ALSO AVAILABLE IN BRONZE

B-22

BUSTER SLIDING CANOPY EXTENDED LAMP HOLDER CORD BLACK CLOTH SUSPENSION CHROME

* ALSO AVAILABLE IN BRONZE

B-22

BUSTER DIY CORD BLACK CLOTH CHROME

THE LATEST INDUSTRIAL LOOK

NEW PRODUCT

B-22

BUSTER RETRO 1/2" x 1/2MT ROD SET CHROME

B-22

BUSTER RETRO 3/4" x 1/2MT ROD SET CHROME

B-22

BUSTER STANDARD 1/2" x 1/2MT ROD SET CHROME

* ALSO AVAILABLE IN BRONZE

B-22

BUSTER STANDARD 3/4" x 1/2MT ROD SET CHROME

* ALSO AVAILABLE IN BRONZE

NEW PRODUCT

B-22

BUSTER SAW TOOTH CHAIN CORD CLOTH 7 COLOURS SUSPENSION CHROME

* ALSO AVAILABLE IN BRONZE

B-22

BUSTER OLD WORD HOOK CHAIN CORD CLOTH 7 COLOURS SUSPENSION CHROME

* ALSO AVAILABLE IN BRONZE

B-22

BUSTER RECESSED WB CHROME FRAME SIZE -
H - 12cm
W - 9cm
P - 7cm

Lighting Inspirations

By - *Lode International* - Circa 1965 -



Globe Required

B-15 B-22 E-14 E-27

Industrial Metal Cage Range

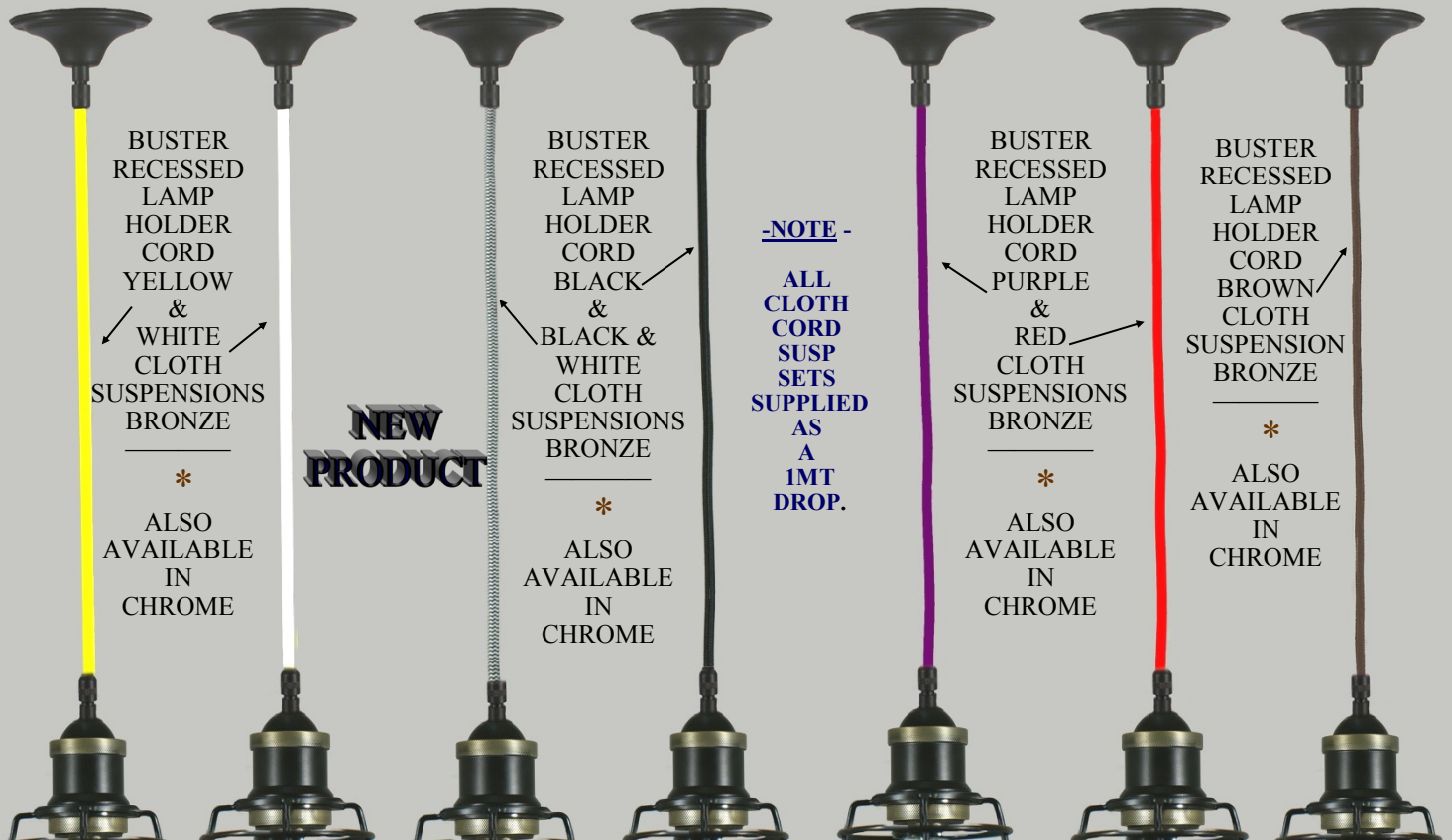

BUSTER RECESSED LAMP HOLDER CORD YELLOW & WHITE CLOTH SUSPENSIONS BRONZE

* ALSO AVAILABLE IN CHROME

NEW PRODUCT

BUSTER RECESSED LAMP HOLDER CORD BLACK & WHITE CLOTH SUSPENSIONS BRONZE

* ALSO AVAILABLE IN CHROME

-NOTE -
ALL CLOTH CORD SUSP SETS SUPPLIED AS A 1MT DROP.

BUSTER RECESSED LAMP HOLDER CORD PURPLE & RED CLOTH SUSPENSIONS BRONZE

* ALSO AVAILABLE IN CHROME

BUSTER RECESSED LAMP HOLDER CORD BROWN CLOTH SUSPENSION BRONZE

* ALSO AVAILABLE IN CHROME



ALCATRAZ BRONZE CAGE SIZE ONLY - H - 22cm W - 16cm



SAN QUENTIN BRONZE CAGE SIZE ONLY - H - 18cm W - 15cm



PENTRIDGE BRONZE CAGE SIZE ONLY - H - 18cm W - 17cm



WASCO BRONZE CAGE SIZE ONLY - H - 20cm W - 20cm

NEW PRODUCT



ALCATRAZ CHROME CAGE SIZE ONLY - H - 22cm W - 16cm



SAN QUENTIN CHROME CAGE SIZE ONLY - H - 18cm W - 15cm



SHAWSHANK BRONZE CAGE SIZE ONLY - H - 20cm W - 12cm



FOUR MILE BRONZE CAGE SIZE ONLY - H - 17cm W - 16cm

NEW PRODUCT

Lighting Inspirations

By - *Lode International* - Circa 1965 -



Globe Required

B-15 B-22 E-14 E-27

Alcatraz & San Quentin Aston & Buster Chrome Range

Top Row (Pendant):

- E-27** SAN QUENTIN CHROME ON ASTON CORD BLACK CLOTH SUSP
- E-27** SAN QUENTIN CHROME ON ASTON CORD WHITE CLOTH SUSP
- E-27** SAN QUENTIN CHROME ON ASTON CORD YELLOW CLOTH SUSP
- E-27** SAN QUENTIN CHROME ON ASTON CORD RED CLOTH SUSP
- E-27** ALCATRAZ CHROME ON ASTON CORD BROWN CLOTH SUSP
- E-27** ALCATRAZ CHROME ON ASTON CORD BLACK CLOTH SUSP
- E-27** ALCATRAZ CHROME ON ASTON CORD PURPLE CLOTH SUSP
- E-27** ALCATRAZ CHROME ON ASTON CORD BLACK & WHITE CLOTH SUSP

Second Row (Wall):

- E-27** SAN QUENTIN ASTON U-ARM WB CHR H-35cm W-17cm P-24cm
- E-27** SAN QUENTIN ASTON STRAIGHT WB CHR H-35cm W-17cm P-24cm
- E-27** ALCATRAZ ASTON U-ARM WB CHR H-35cm W-17cm P-24cm
- E-27** ALCATRAZ BUSTER STRAIGHT WB CHR H-31cm W-16cm P-24cm

Third Row (Pendant):

- B-22** SAN QUENTIN CHROME ON BUSTER CORD BLACK CLOTH SUSP
- B-22** SAN QUENTIN CHROME ON BUSTER CORD WHITE CLOTH SUSP
- B-22** SAN QUENTIN CHROME ON BUSTER CORD YELLOW CLOTH SUSP
- B-22** SAN QUENTIN CHROME ON BUSTER CORD RED CLOTH SUSP
- B-22** ALCATRAZ CHROME ON BUSTER CORD BROWN CLOTH SUSP
- B-22** ALCATRAZ CHROME ON BUSTER CORD BLACK CLOTH SUSP
- B-22** ALCATRAZ CHROME ON BUSTER CORD PURPLE CLOTH SUSP
- B-22** ALCATRAZ CHROME ON BUSTER CORD BLACK & WHITE CLOTH SUSP

Fourth Row (Rod Sets):

- E-27** SAN QUENTIN BRZ ASTON ROD SET
- E-27** SAN QUENTIN BRZ BUSTER ROD SET
- E-27** ALCATRAZ BRZ ASTON ROD SET
- E-27** ALCATRAZ BRZ BUSTER ROD SET

Fifth Row (Flush Sets):

- E-27** SAN QUENTIN BRZ ASTON FLUSH SET
- E-27** SAN QUENTIN BRZ BUSTER FLUSH SET
- E-27** ALCATRAZ BRZ ASTON FLUSH SET
- E-27** ALCATRAZ BRZ BUSTER FLUSH SET

Frame Sizes:

- FRAME SIZE H - 100+cm ADJ W - 16cm
- FRAME SIZE H - 75cm ADJ W - 16cm
- FRAME SIZE H - 25cm W - 16cm
- FRAME SIZE H - 28cm W - 16cm

Other Labels:

- ALSO IN BRZ** (for wall and rod sets)
- ALSO IN D.I.Y** (for B-22 pendant)

Lighting Inspirations



By - *Lode International* - Circa 1965 -

Globe Required

(B-15) (B-22) (E-14) (E-27)

Alcatraz & San Quentin Aston & Buster Bronze Range

*** ALL *
CLOTH CORD
SUSPENSIONS ARE
SUPPLIED
IN A 1 MT LENGTH**

**NOTE -
ROD PENDANTS
SUPPLIED
WITH
1/2 METER ROD DROP.
1/2 METER EXTENSIONS
AVAILABLE**

**NEW
PRODUCT**

**FRAME SIZE
H - 100+cm
ADJUSTABLE
W - 16cm**

**FRAME SIZE
H - 100+cm
ADJUSTABLE
W - 16cm**

**FRAME SIZE
H - 75cm ADJ
W - 16cm**

**FRAME SIZE
H - 75cm ADJ
W - 16cm**

**FRAME SIZE
H - 25cm W - 16cm**

**FRAME SIZE
H - 28cm W - 16cm**

San Quentin Bronze on Aston Cord Brown Cloth Susp

San Quentin Bronze on Aston Cord White Cloth Susp

San Quentin Bronze on Aston Cord Yellow Cloth Susp

San Quentin Bronze on Aston Cord Red Cloth Susp

Alcatraz Bronze on Aston Cord Black White Cloth Susp

Alcatraz Bronze on Aston Cord Black Cloth Susp

Alcatraz Bronze on Aston Cord Purple Cloth Susp

Alcatraz Bronze on Aston Cord Brown Cloth Susp

San Quentin Bronze on Buster Cord Brown Cloth Susp

San Quentin Bronze on Buster Cord White Cloth Susp

San Quentin Bronze on Buster Cord Yellow Cloth Susp

San Quentin Bronze on Buster Cord Red Cloth Susp

Alcatraz Bronze on Buster Cord Black White Cloth Susp

Alcatraz Bronze on Buster Cord Black Cloth Susp

Alcatraz Bronze on Buster Cord Purple Cloth Susp

Alcatraz Bronze on Buster Cord Brown Cloth Susp

San Quentin Brz Aston Rod Set

Alcatraz Brz Aston Rod Set

San Quentin Brz Buster Rod Set

Alcatraz Brz Buster Rod Set

San Quentin Brz Aston Flush Set

San Quentin Brz Buster Flush Set

Alcatraz Brz Aston Flush Set

Alcatraz Brz Buster Flush Set

Lighting Inspirations

By - *Lode International - Circa 1965 -*



Globe Required

B-15 B-22 E-14 E-27

Industrial Range

THE LATEST INDUSTRIAL LOOK

INDUSTRIAL 1/LT CLEAR FLEX PND SATIN NICKEL

FRAME SIZE
H - 200cm
MAX
W - 32cm

E-27

INDUSTRIAL STANDARD 2/LT BENCH PND BRONZE

FRAME SIZE
MINIMUM H - 115cm
EXPANDABLE TO
MAXIMUM H - 165
W - 90cm
WITH
TELESCOPIC ROD

E-27

THE LATEST INDUSTRIAL LOOK

INDUSTRIAL 1/LT BLACK FLEX PND BRONZE

FRAME SIZE
H - 200cm
MAX
W - 32cm

E-27

INDUSTRIAL STANDARD 1/LT ROD PND SATIN NICKEL

FRAME SIZE
MINIMUM H - 82cm
EXPANDABLE TO
MAXIMUM
H - 131cm W - 32cm
WITH
TELESCOPIC ROD

E-27

INDUSTRIAL STANDARD 2/LT BENCH PND SATIN NICKEL

FRAME SIZE
MINIMUM H - 115cm
EXPANDABLE TO
MAXIMUM H - 165
W - 90cm
WITH
TELESCOPIC ROD

E-27

INDUSTRIAL STANDARD 1/LT ROD PND BRONZE

FRAME SIZE
MINIMUM H - 82cm
EXPANDABLE TO
MAXIMUM
H - 131cm W - 32cm
WITH
TELESCOPIC ROD

E-27

QUALITY INDUSTRIAL PRODUCT

INDUSTRIAL STANDARD 3/LT BENCH PND SATIN NICKEL

E-27

INDUSTRIAL INBUILT EXPANDABLE TELESCOPIC ROD

FRAME SIZE
MINIMUM H - 125cm
EXPANDABLE TO
MAXIMUM H - 175 W - 135cm
WITH
TELESCOPIC ROD

INDUSTRIAL STANDARD 3/LT BENCH PND BRONZE

E-27

Lighting Inspirations



By - *Lode International* - Circa 1965 -

Globe Required

B-15 B-22 E-14 E-27

Industrial Range "Optional Fixed Heights"

INDUSTRIAL 3/LT
OPTION - A -
12" FIXED ROD
BENCH PND
SATIN NICKEL

THE LATEST INDUSTRIAL LOOK

FRAME SIZE
H - 92cm W - 135cm

INDUSTRIAL 2/LT
OPTION - A -
12" FIXED ROD
BENCH PND
SATIN NICKEL

FRAME SIZE
H - 84cm W - 90cm

INDUSTRIAL 1/LT
OPTION - A -
12" FIXED ROD
SINGLE PND
SATIN NICKEL

FRAME SIZE
H - 49.5cm W - 32cm

INDUSTRIAL 3/LT
OPTION - B -
8" FIXED ROD
BENCH PND
SATIN NICKEL

FRAME SIZE
H - 82m W - 135cm

INDUSTRIAL 2/LT
OPTION - B -
8" FIXED ROD
BENCH PND
SATIN NICKEL

FRAME SIZE
H - 74cm W - 90cm

INDUSTRIAL 1/LT
OPTION - B -
8" FIXED ROD
SINGLE PND
SATIN NICKEL

FRAME SIZE
H - 39.5cm W - 32cm

INDUSTRIAL 3/LT
OPTION - C -
4" FIXED ROD
BENCH PND
SATIN NICKEL

QUALITY INDUSTRIAL PRODUCT

FRAME SIZE
H - 72cm W - 135cm

INDUSTRIAL 2/LT
OPTION - C -
4" FIXED ROD
BENCH PND
SATIN NICKEL

FRAME SIZE
H - 64cm W - 90cm

INDUSTRIAL 1/LT
OPTION - C -
4" FIXED ROD
SINGLE PND
SATIN NICKEL

FRAME SIZE
H - 29.5cm W - 32cm

INDUSTRIAL 3/LT
OPTION - D -
FLUSH
BENCH PND
SATIN NICKEL

FRAME SIZE
H - 62cm W - 135cm

INDUSTRIAL 2/LT
OPTION - D -
FLUSH
BENCH PND
SATIN NICKEL

FRAME SIZE
H - 54cm W - 90cm

**- ALSO -
AVAILABLE**

**INDUSTRIAL
RANGE
IN
BRONZE
WITH SAME
OPTIONS**

Lighting Inspirations

By - Lode International - Circa 1965 -



Globe Required

B-15 B-22 E-14 E-27

Gatsby Range

**QUALITY
CLEAR
GLASSWARE**

**NEW
PRODUCT**

*** ALL *
CHAIN
PENDANTS
ARE
SUPPLIED
WITH
1
METER
CHAIN**

GATSBY
SMALL
BRONZE
FRAME SIZE -
H - 40cm
W - 27cm

E-27

GATSBY
SMALL
CHROME
FRAME SIZE -
H - 40cm
W - 27cm

E-27

*** ALL *
CHAIN
PENDANTS
ARE
SUPPLIED
WITH
1
METER
CHAIN**

GATSBY
LARGE
BRONZE
FRAME SIZE -
H - 53cm
W - 44cm

E-27

GATSBY
LARGE
CHROME
FRAME SIZE -
H - 53cm
W - 44cm

E-27

**CLASSIC
INDUSTRIAL
STYLE
GLASSWARE
PENDANT**

**NEW
PRODUCT**

Lighting Inspirations

By - *Lode International* - Circa 1965 -



Globe Required

Clear Glassware Range

B-15 B-22 E-14 E-27

**THE
LATEST
NEW YORK
STUDIO
CLEAR
GLASSWARE
TREND**

* ALL *
CHAIN
PENDANTS
ARE
SUPPLIED
WITH
1
METER
CHAIN

LORIENT
LARGE 4/LT
PND CHROME
FRAME SIZE
WITH OUT CHAIN
H - 48cm
W - 35cm



E-14

LORIENT
MEDIUM 1/LT
PND CHROME
FRAME SIZE
WITH OUT CHAIN
H - 37cm
W - 25cm



E-27

**NEW
PRODUCT**

**NEW
PRODUCT**

KRAMER
PND 1/LT
CHROME
FRAME SIZE
WITH OUT FLEX
H - 50cm
W - 29cm



E-27

* ALL *
FLEX
PENDANTS
ARE
SUPPLIED
WITH
1
METER
FLEX

**NEW
PRODUCT**

GLOBO
1LT PND
CHROME
FRAME SIZE
WITH OUT FLEX
H - 33cm
W - 19cm

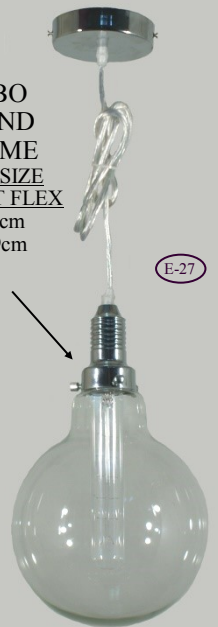

E-27

* ALL *
CHAIN
PENDANTS
ARE
SUPPLIED
WITH
1
METER
CHAIN

LORIENT
SMALL 1/LT
PND CHROME
FRAME SIZE
WITH OUT CHAIN
H - 30cm
W - 17cm



E-27

**NEW
PRODUCT**

BOURGES
4/LT PND
CHROME
FRAME SIZE
WITH OUT CHAIN
H - 73cm
W - 37cm



E-27

Lighting Inspirations

By - *Lode International* - Circa 1965 -



Globe Required

Clear Glassware Range

B-15 B-22 E-14 E-27

SPHERE 8"
CLEAR
BISTRO RETRO
SLIDING
CANOPY CLOTH
CORD SUSP CHR
H-100+cm (ADJUSTABLE)
W-20cm



B-22

**L-I
EXCLUSIVE
CLEAR
GLASSWARE**

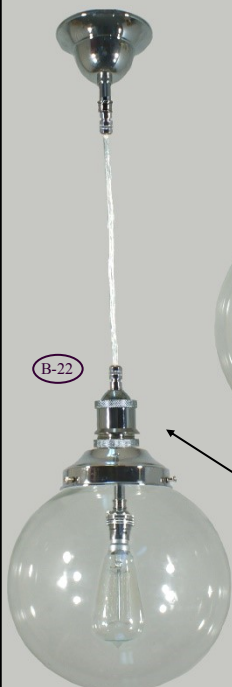

B-22

SPHERE 8"
CLEAR
BUSTER BISTRO
4 1/4" SLIDING
CANOPY CLOTH
CORD SUSP CHR
H-100+cm
(ADJUSTABLE)
W-20cm

SPHERE 10"
CLEAR
BISTRO RETRO
4 1/4"
ROD SET
1/2" x 1/2MT
CHROME
H-80cm
(ADJUSTABLE)
W-25cm



B-22

**NEW
PRODUCT**



B-22

ST HELENS
CLEAR
RETRO 6 1/4"
ROD SET
3/4" x 1/2MT
CHROME
H-82cm
(ADJUSTABLE)
W-32cm

ST KILDA 8"
CLEAR
RETRO 4 1/4"
ROD SET
1/2" x 1/2MT
CHROME
H-73cm
(ADJUSTABLE)
W-21cm



B-22



B-22

DOME C
CLEAR
RETRO 4 1/4"
ROD SET
1/2" x 1/2MT
CHROME
H-70cm
(ADJUSTABLE)
W-20cm

CANNES
CLEAR
RETRO 4 1/4"
ROD SET
1/2" x 1/2MT
CHROME
H-70cm
(ADJUSTABLE)
W-22cm



B-22



B-22

CHATEAU
CLEAR
RETRO 6 1/4"
ROD SET
1/2" x 1/2MT
CHROME
H-70cm
(ADJUSTABLE)
W-28cm

**NEW
PRODUCT**

SPHERE 10"
CLEAR
BUSTER
BISTRO 4 1/4"
ROD SET
1/2" x 1/2MT
CHROME
H-80cm
(ADJUSTABLE)
W-25cm

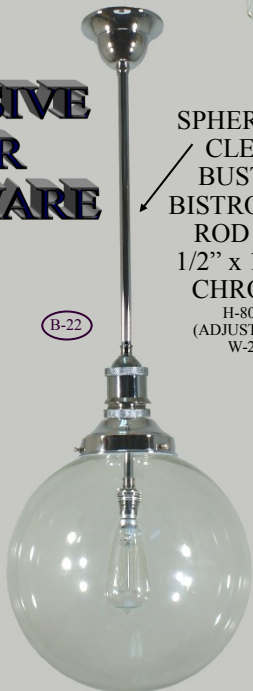

B-22

ST HELENS
CLEAR
BUSTER
ROD SET
3/4" x 1/2MT
CHROME
&
6 1/4" FITTER
H-82cm
(ADJUSTABLE)
W-32cm



B-22

ST KILDA 8"
CLEAR
BUSTER
ROD SET
1/2" x 1/2MT
CHROME
&
4 1/4" FITTER
H-73cm
(ADJUSTABLE)
W-21cm



B-22

CANNES
CLEAR
BUSTER
ROD SET
1/2" x 1/2MT
CHROME
&
4 1/4" FITTER
H-70cm
(ADJUSTABLE)
W-22cm



B-22

CHATEAU
CLEAR
BUSTER
ROD SET
1/2" x 1/2MT
CHROME
&
6 1/4" FITTER
H-70cm
(ADJUSTABLE)
W-28cm



B-22

DOME C
CLEAR
BUSTER
ROD SET
1/2" x 1/2MT
CHROME
&
4 1/4" FITTER
H-70cm
(ADJUSTABLE)
W-20cm

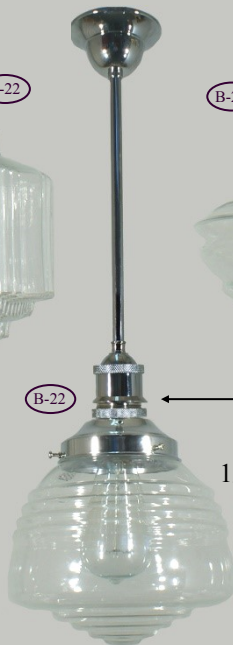

B-22

Lighting Inspirations

By - *Lode International* - Circa 1965 -



Globe Required

Clear Glassware Range

B-15 B-22 E-14 E-27

SPHERE 8" CLEAR BISTRO SLIDING CANOPY CLOTH CORD SUSP PATINA
H-100+cm (ADJUSTABLE) W-20cm

SPHERE 10" CLEAR BISTRO 4 1/4" ROD SET 1/2" x 1/2MT PATINA
H-80cm (ADJUSTABLE) W-25cm

ST HELENS CLEAR STANDARD ROD SET 3/4" x 1/2MT PATINA & 6 1/4" FITTER (ADJUSTABLE)
H-82cm W-32cm

ST KILDA 8" CLEAR STANDARD ROD SET 1/2" x 1/2MT PATINA & 4 1/4" FITTER (ADJUSTABLE)
H-73cm W-21cm

CANNES CLEAR STANDARD ROD SET 1/2" x 1/2MT PATINA & 4 1/4" FITTER (ADJUSTABLE)
H-70cm W-22cm

CHATEAU CLEAR STANDARD ROD SET 1/2" x 1/2MT PATINA & 6 1/4" FITTER (ADJUSTABLE)
H-70cm W-28cm

DOMEC CLEAR STANDARD ROD SET 1/2" x 1/2MT PATINA & 4 1/4" FITTER (ADJUSTABLE)
H-70cm W-20cm

NEW PRODUCT

L-I EXCLUSIVE CLEAR GLASSWARE

SPHERE 10" CLEAR BUSTER BISTRO 4 1/4" ROD SET 1/2" x 1/2MT PATINA
H-80cm (ADJUSTABLE) W-25cm

ST HELENS CLEAR BUSTER ROD SET 3/4" x 1/2MT PATINA & 6 1/4" FITTER (ADJUSTABLE)
H-82cm W-32cm

ST KILDA 8" CLEAR BUSTER ROD SET 1/2" x 1/2MT PATINA & 4 1/4" FITTER (ADJUSTABLE)
H-73cm W-21cm

CANNES CLEAR BUSTER ROD SET 1/2" x 1/2MT PATINA & 4 1/4" FITTER (ADJUSTABLE)
H-70cm W-22cm

CHATEAU CLEAR BUSTER ROD SET 1/2" x 1/2MT PATINA & 6 1/4" FITTER (ADJUSTABLE)
H-70cm W-28cm

SPHERE 8" CLEAR BUSTER BISTRO 4 1/4" SLIDING CANOPY CLOTH CORD SUSP PATINA
H-100+cm (ADJUSTABLE) W-20cm

DOMEC CLEAR BUSTER ROD SET 1/2" x 1/2MT PATINA & 4 1/4" FITTER (ADJUSTABLE)
H-70cm W-20cm

NEW PRODUCT

Lighting Inspirations

By - *Lode International* - Circa 1965 -



Globe Required

Newark, Orbita & Foix Range

(B-15) (B-22) (E-14) (E-27)

NOTE -
ROD SET SHOWN IS 1/2 MT ALSO AVAILABLE 1MT DROP.

THE LATEST INDUSTRIAL LOOK

QUALITY CLEAR GLASSWARE

NEW PRODUCT

NEWARK UP LARGE
2/LT PND
1/2" x 1/2MT
CHROME
H-83cm (ADJUSTABLE)
W-25cm

(B-15)

NEWARK UP SMALL
2/LT PND
1/2" x 1/2MT
CHROME
H-78cm (ADJUSTABLE)
W-17cm

(B-15)

FOIX MEDIUM SATIN NICKLE
HEAD SIZE ONLY -
H-42cm W-28cm

(E-27)

FOIX LARGE SATIN NICKLE
HEAD SIZE ONLY -
H-45cm W-32cm

(E-27)

NOTE -
ROD SET SHOWN IS 1/2 MT ALSO AVAILABLE 1MT DROP.

NEWARK DOWN SMALL PENDANT
1/2" x 1/2MT
CHROME
H-73cm (ADJUSTABLE)
W-17cm

(B-22)

NEWARK DOWN LARGE PENDANT
1/2" x 1/2MT
CHROME
H-78cm (ADJUSTABLE)
W-25cm

(B-22)

ORBITA 3LT PND SATIN CHROME
FRAME SIZE WITH OUT RODS
H - 56cm
W - 47cm
SUPPLIED WITH
2 x 30cm RODS
1 x 40cm ROD

(E-14)

MEASUREMENTS:
70mm
150mm
310mm
1000mm
310mm
310mm

Lighting Inspirations

By - Lode International - Circa 1965 -



Globe Required

B-15 B-22 E-14 E-27

Trillion, Diamond, Vintage, Chester & Poirot Range

* ALL *
CHAIN
PENDANTS
ARE
SUPPLIED
WITH
1
METER
CHAIN

**NEW
PRODUCT**

**NEW
PRODUCT**

**NEW
PRODUCT**

CHESTER
FLOAT LIGHT 3/LT
ANTIQUE BRASS
FRAME SIZE ONLY
NO CHAIN -
H - 55cm W - 30cm

E-14

VINTAGE
INDUSTRIAL
CAGE
FRAME SIZE
WITH OUT CHAIN
H - 41cm
W - 45cm

E-27

TRILLION
TRAP DOOR
OPENING
FOR GLOBE
REPLACEMENT
FRAME SIZE
WITH OUT RODS
H - 40cm
W - 36cm
SUPPLIED WITH
2 x 30cm RODS
1 x 40cm ROD
KNUCKLE CANOPY

E-14

POIROT
4/LT PENDANT
BRONZE
FRAME SIZE
WITH OUT CHAIN
H - 58cm
W - 40cm

E-14

DIAMOND
TRAP DOOR
OPENING
FOR GLOBE
REPLACEMENT
FRAME SIZE
WITH OUT RODS
H - 49cm
W - 30cm
SUPPLIED WITH
2 x 30cm RODS
1 x 40cm ROD
KNUCKLE CANOPY

E-27

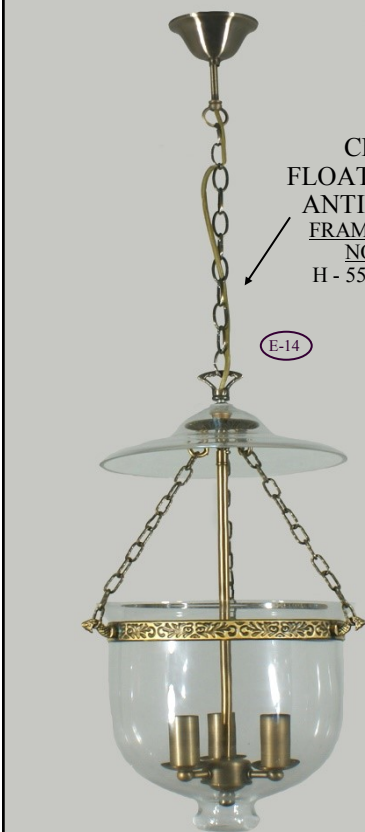

Lighting Inspirations

By - *Lode International* - Circa 1965 -



Globe Required

B-15 B-22 E-14 E-27

Moda Chrome Range

**QUALITY
OPAL SUEDE
GLASSWARE**

**NEW
PRODUCT**

- NOTE -

**ROD
SYSTEM
SAME
AS
LARGE**

- NOTE -

**ROD
SYSTEM
SAME
AS
LARGE**

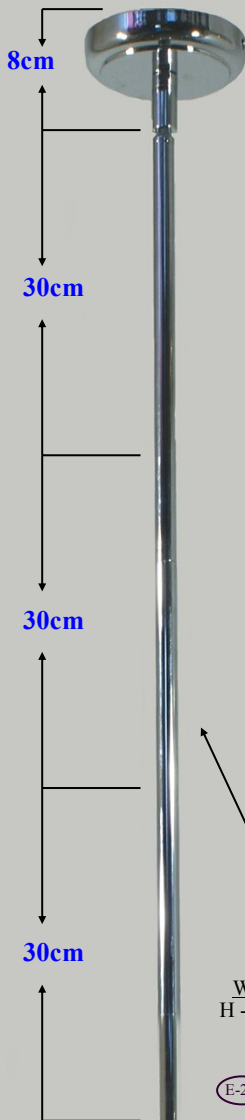

MODA
LARGE
4/LT PND
CHROME
FRAME SIZE
WITH OUT ROD
H - 65cm W - 42cm

E-27



MODA
MEDIUM
3/LT PND
CHROME
FRAME SIZE
WITH OUT ROD
H - 53cm W - 35cm

E-27



MODA
SMALL
1/LT PND
CHROME
FRAME SIZE
WITH OUT ROD
H - 42cm W - 27cm

E-27



**NEW
PRODUCT**

Lighting Inspirations

By - Lode International - Circa 1965 -



Globe Required

B-15 B-22 E-14 E-27

Cubo & Sfera Range

CUBO ASTON LARGE & SMALL BRONZE

(E27)

CLOTH CORD OPTIONS

- AVAILABLE -
CLOTH CORD COLORS
BLACK-BLACK & WHITE
PURPLE-WHITE-RED
YELLOW-BROWN

CUBO SMALL BRONZE
FRAME SIZE -
H - 230mm W - 285mm

(E27)

CLOTH CORD OPTIONS

- AVAILABLE -
CLOTH CORD COLORS
BLACK-BLACK & WHITE
PURPLE-WHITE-RED
YELLOW-BROWN

CUBO SMALL CHROME
FRAME SIZE -
H - 230mm W - 285mm

(E27)

CUBO ASTON ROD SET 1/2" x 1/2MT LARGE CHROME & BRONZE

- ALSO -
CUBO ASTON ROD SET 1/2" x 1/2MT SMALL CHROME & BRONZE

(E27)

CUBO LARGE BRONZE
FRAME SIZE -
H - 285mm W - 362mm

(E27)

CLOTH CORD SUSPENSIONS ARE SUPPLIED IN A 1 MT LENGTH

CUBO LARGE CHROME
FRAME SIZE -
H - 285mm W - 362mm

(E27)

SFERA SMALL CHROME
FRAME SIZE
H - 250mm W - 255mm

(E27)

CLOTH CORD OPTIONS

- AVAILABLE -
CLOTH CORD COLORS
BLACK-BLACK & WHITE
PURPLE-WHITE-RED
YELLOW-BROWN

SFERA LARGE CHROME
FRAME SIZE
H - 350mm W - 357mm

(E27)

SFERA ASTON ROD SET 1/2" x 1/2MT LARGE CHROME

- ALSO -
SFERA ASTON ROD SET 1/2" x 1/2MT SMALL CHROME

(E27)

NOTE - ROD PENDANTS SUPPLIED WITH 1/2 METER ROD DROP. 1/2 METER EXTENSIONS AVAILABLE

Lighting Inspirations

By - Lode International - Circa 1965 -



Globe Required

B-15 B-22 E-14 E-27

Float & Lantern Range

**UNIQUE
CLEAR
RIBBED
GLASSWARE**

**QUALITY
CLEAR
GLASSWARE**



NEW STOCK E27

B22

MIAMI LANTERN
1/LT
CHROME
FRAME SIZE -
H - 54cm W - 26cm

MADISON LANTERN
3/LT
CHROME
FRAME SIZE -
H - 58cm W - 25cm

SOISSON PENDANT
3/LT
CHROME
FRAME SIZE -
H - 55cm
W - 26cm

B15
NEW STOCK E14

E14

**NEW
PRODUCT**

* SUPPLIED *
WITH
1
METER
CHAIN

* SUPPLIED *
WITH
1
METER
CHAIN

AUSTIN LANTERN
1/LT
CHROME
FRAME SIZE -
H - 65cm W - 28cm

SOISSON SEMI FLUSH
1/LT CHROME
FRAME SIZE -
H - 38cm W - 26cm

NEW STOCK E27

B22

E-27

Lighting Inspirations

By - *Lode International - Circa 1965 -*



Globe Required

(B-15) (B-22) (E-14) (E-27)

Salford, Michigan & Vermont Wall Sconce Range

SALFORD
PENDANT
3/LT
BRONZE
FRAME SIZE -
H - 77cm
W - 29cm



(E14)



(E14)

SALFORD FLUSH
3/LT BRONZE
FRAME SIZE -
H - 32cm W - 29cm

**NOTE -
ROD
PENDANTS
SUPPLIED
WITH
1/2 METER
ROD DROP.
1/2 METER
EXTENSIONS
AVAILABLE**

SALFORD
PENDANT
3/LT
CHROME
FRAME SIZE -
H - 77cm
W - 29cm

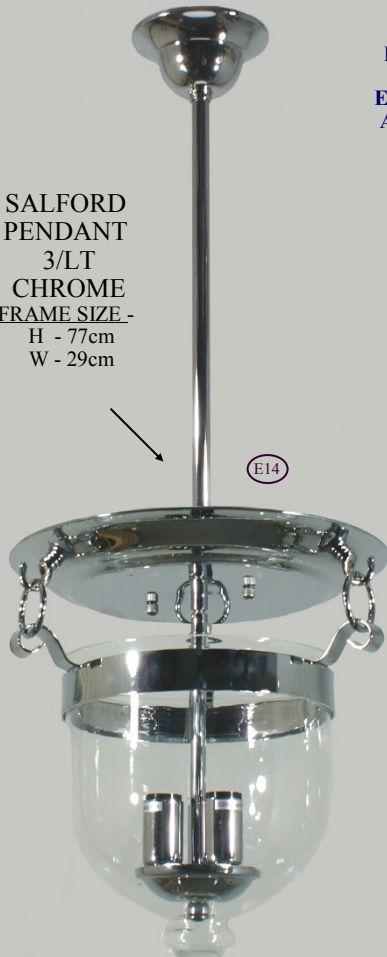

(E14)



(E14)

SALFORD FLUSH
3/LT CHROME
FRAME SIZE -
H - 32cm W - 29cm

MICHIGAN
WALL
SCONCE 2/LT
BRONZE
FRAME SIZE
H - 29cm
W - 20cm
P - 11cm



(E14)

MICHIGAN
WALL
SCONCE 2/LT
CHROME
FRAME SIZE
H - 29cm
W - 20cm
P - 11cm

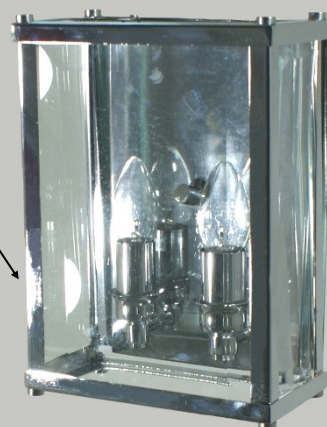

(E14)

**NEW
PRODUCT**

VERMONT
WALL
SCONCE 2/LT
BRONZE
FRAME SIZE
H - 28cm
W - 20cm
P - 11cm



(E14)

VERMONT
WALL
SCONCE 2/LT
CHROME
FRAME SIZE
H - 28cm
W - 20cm
P - 11cm



(E14)

Lighting Inspirations

By - *Lode International - Circa 1965 -*



Globe Required

B-15 B-22 E-14 E-27

Lantern Range

**CURVED
CLEAR
BEVELED
GLASSWARE
FEATURED
ON
NEBRASKA**

* SUPPLIED *
WITH
1
METER
CHAIN

NEBRASKA
SMALL
LANTERN
3/LT CHROME
FRAME SIZE -
H - 42cm W - 32cm

* SUPPLIED *
WITH
1
METER
CHAIN

NEBRASKA
LARGE
LANTERN
5/LT CHROME
FRAME SIZE -
H - 52cm W - 41cm

VERMONT
C.T.C LANTERN
4/LT CHROME
FRAME SIZE -
H - 39cm W - 42cm

VERMONT
WALL SCONCE
2/LT
CHROME
FRAME SIZE
H - 28cm
W - 20cm
P - 11cm

**NOTE -
ROD
PENDANTS
SUPPLIED
WITH
1/2 METER
ROD
DROP.
1/2 METER
EXTENSIONS
AVAILABLE**

**NEW
PRODUCT**

VERMONT PND
LANTERN
4/LT CHROME
FRAME SIZE -
H - 39cm W - 42cm

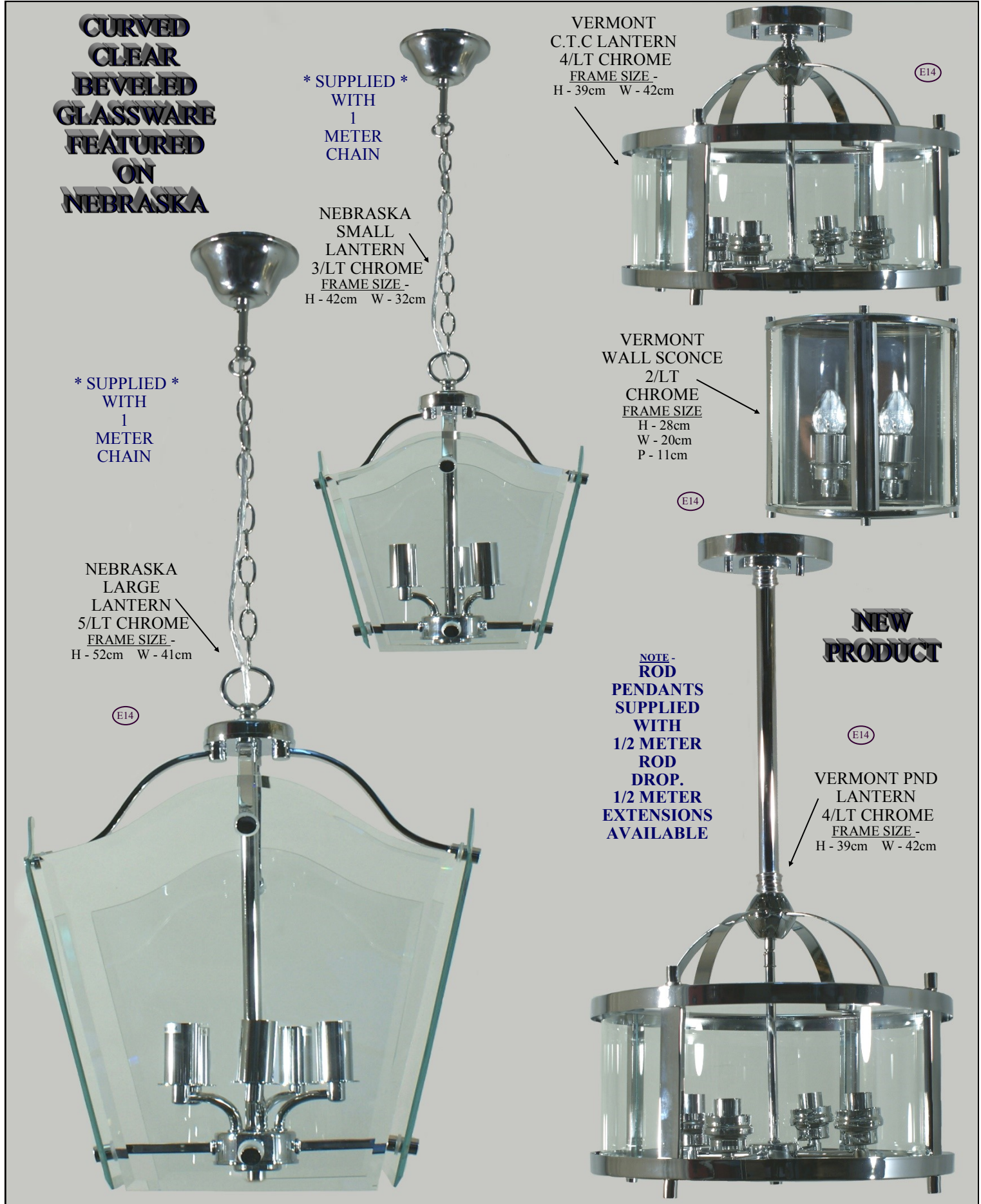

Lighting Inspirations



By - *Lode International* - Circa 1965 -

Globe Required

Modern Lantern Range

(B-15) (B-22) (E-14) (E-27)

* SUPPLIED *
WITH
1
METER
CHAIN

NOTE -
ROD PENDANTS
SUPPLIED WITH
1/2 METER ROD DROP.
1/2 METER EXTENSIONS
ARE AVAILABLE

* SUPPLIED *
WITH
1
METER
CHAIN

SOHO
STANDARD
ROD
LANTERN
4/LT
CHROME
FRAME SIZE -
H - 57cm W - 28cm
HEIGHT
INCLUDING
ROD 100cm

SOHO
CHAIN
LANTERN
4/LT CHROME
FRAME SIZE -
H - 57cm W - 28cm

SOHO
RETRO
ROD
LANTERN
4/LT CHROME
FRAME SIZE -
H - 57cm W - 28cm
HEIGHT INCLUDING
ROD 100cm

STATEN
CHAIN
LANTERN
3/LT CHROME
FRAME SIZE -
H - 54cm W - 26cm



**SOHO & AURORA
RANGE
HAVE NO GLASS**

**STATEN RANGE
HAS ROUND CLEAR
GLASS PANELS**

NOTE -
ROD PENDANTS
SUPPLIED WITH
1/2 METER ROD DROP.
1/2 METER EXTENSIONS
ARE AVAILABLE

NOTE -
ROD
PENDANTS
SUPPLIED
WITH
1/2 METER
ROD
DROP.
1/2 METER
EXTENSIONS
AVAILABLE

AURORA
CHAIN
LANTERN
4/LT CHROME
FRAME SIZE -
H - 52cm W - 42cm

* SUPPLIED *
WITH
1
METER
CHAIN

AURORA
RETRO
ROD
LANTERN
4/LT CHROME
FRAME SIZE -
H - 52cm W - 42cm
HEIGHT INCLUDING
ROD 95cm

NOTE -
ROD
PENDANTS
SUPPLIED
WITH
1/2 METER
ROD
DROP.
1/2 METER
EXTENSIONS
AVAILABLE

AURORA
STANDARD
ROD
LANTERN
4/LT CHROME
FRAME SIZE -
H - 52cm W - 42cm
HEIGHT INCLUDING
ROD 95cm

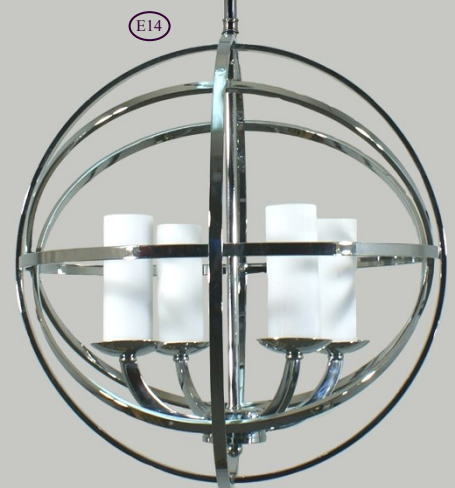

Lighting Inspirations

By - *Lode International* - Circa 1965 -



Globe Required

B-15 B-22 E-14 E-27

Lantern Range



E-14
MICHIGAN
WALL SCONCE
2/LT
CHROME
FRAME SIZE
H - 29cm
W - 20cm
P - 11cm



MICHIGAN
LANTERN
SMALL
1/LT
CHROME
FRAME SIZE
H - 49cm W - 20cm

* SUPPLIED *
WITH
1
METER
CHAIN



MONTANA
LANTERN
SMALL
3/LT
CHROME
FRAME SIZE
H - 59cm W - 27cm

**CLEAR
BEVELED
GLASSWARE**

**NEW
PRODUCT**



MICHIGAN
LANTERN
MEDIUM
3/LT
CHROME
FRAME SIZE
H - 60cm W - 28cm



E-27



E-14

* SUPPLIED *
WITH
1
METER
CHAIN



E-14



E-14

MONTANA
LANTERN
MEDIUM
4/LT
CHROME

FRAME SIZE
H - 72cm W - 38cm

Lighting Inspirations

By - *Lode International* - Circa 1965 -



Globe Required

B-15 B-22 E-14 E-27

Lantern Range



E-14

MICHIGAN WALL SCONCE
2/LT
BRONZE
FRAME SIZE
H - 29cm
W - 20cm
P - 11cm

NEW PRODUCT



MICHIGAN LANTERN SMALL
1/LT
BRONZE

FRAME SIZE
H - 49cm W - 20cm

E-27

* SUPPLIED *
WITH
1
METER
CHAIN

MONTANA LANTERN SMALL
3/LT
BRONZE

FRAME SIZE
H - 59cm
W - 27cm

CLEAR BEVELED GLASSWARE

E-14



MICHIGAN LANTERN MEDIUM
3/LT
BRONZE

FRAME SIZE
H - 60cm W - 28cm



* SUPPLIED *
WITH
1
METER
CHAIN

E-14

MONTANA LANTERN MEDIUM
4/LT
BRONZE

FRAME SIZE
H - 72cm W - 38cm

E-14



Lighting Inspirations

By - Lode International - Circa 1965 -



Globe Required

B-15 B-22 E-14 E-27

Lantern Range

**CLEAR
BEVELED
GLASSWARE**

COUNTRY
LANTERN
SMALL
1/LT
BRONZE

FRAME SIZE
H - 55cm W - 30cm

E27

* SUPPLIED *
WITH
1
METER
CHAIN

COUNTRY
LANTERN
LARGE
4/LT
BRONZE

FRAME SIZE
H - 80cm W - 47cm

E14

COUNTRY
LANTERN
MEDIUM
3/LT
BRONZE

FRAME SIZE
H - 62cm W - 37cm

E14



Lighting Inspirations



By - *Lode International - Circa 1965 -*

Globe Required

Oregon Chrome & Bronze Range

B-15 B-22 E-14 E-27

OREGON SMALL C.T.C 1/LT CHROME
FRAME SIZE -
H - 38cm W - 27cm

OREGON SMALL C.T.C 1/LT BRONZE
FRAME SIZE -
H - 38cm W - 27cm

NEW PRODUCT

QUALITY CLEAR BEVELED GLASSWARE ON LARGE & SMALL

OREGON LARGE BENCH 4/LT BRONZE

OREGON SMALL PENDANT 1/LT CHROME

NEW PRODUCT

OREGON SMALL PENDANT 1/LT BRONZE

OREGON LARGE BENCH 4/LT CHROME

Dimensions shown in the diagram:
- Oregon Small C.T.C 1/LT Chrome: 30cm height from top to bottom of frame, 27cm width.
- Oregon Small C.T.C 1/LT Bronze: 30cm height from top to bottom of frame, 27cm width.
- Oregon Large Bench 4/LT Bronze: 98cm total height, 30cm from top to first light, 30cm between lights, 30cm from last light to bottom of frame.
- Oregon Small Pendant 1/LT Chrome: 30cm height from top of frame to bottom of frame, 27cm width.
- Oregon Small Pendant 1/Lt Bronze: 91cm total height, 28cm from top to first light, 28cm between lights, 28cm from last light to bottom of frame.
- Oregon Large Bench 4/LT Chrome: 104cm width, 30cm height.

Lighting Inspirations

By - *Lode International* - Circa 1965 -



Globe Required

(B-15) (B-22) (E-14) (E-27)

Lantern Range



NOTE -
LANTERN
CHAIN
SUPPLIED
AS A
1MT
DROP.

**NEW
PRODUCT**

**NEW
PRODUCT**



NOTE -
LANTERN
CHAIN
SUPPLIED
AS A
1MT
DROP.

Lighting Inspirations

By - *Lode International* - Circa 1965 -



Globe Required

(B-15) (B-22) (E-14) (E-27)

Cosmopolitan Range

NOTE -
ROD
AVAILABLE
1/2 MT
OR
1MT
SQUARE DROP.
IT
CAN BE
SHORTENED
BUT
NOT
EXTENDED



COSMOPOLITAN
SMALL
ROD SET
1/2 MT
CHROME

FRAME SIZE -
H - 67cm
(ADJUSTABLE)
W - 145mm

(E-27)

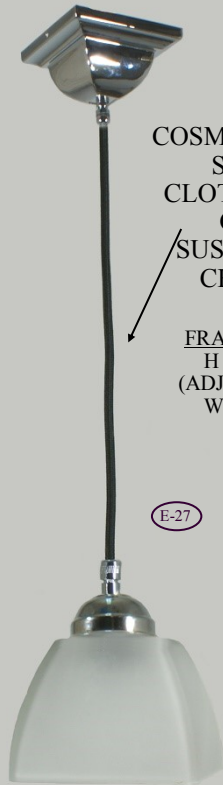

COSMOPOLITAN
SMALL
CLOTH BLACK
CORD
SUSPENSION
CHROME

FRAME SIZE -
H - 100+cm
(ADJUSTABLE)
W - 145mm

(E-27)



COSMOPOLITAN
LARGE
DOWN
ROD SET
1/2 MT
CHROME

FRAME SIZE -
H - 69cm
(ADJUSTABLE)
W - 32cm

(E-27)

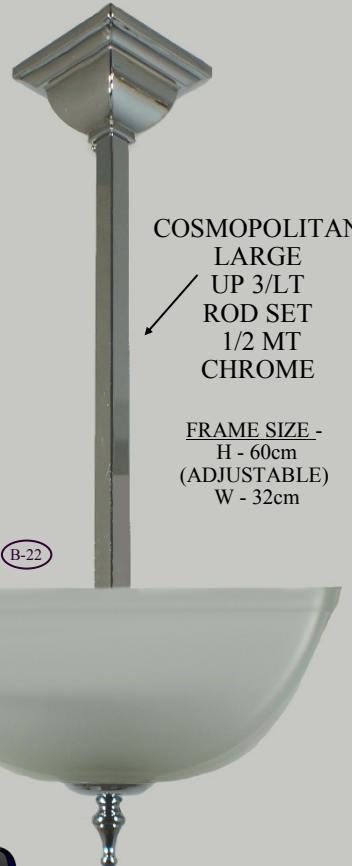

COSMOPOLITAN
LARGE
UP 3/LT
ROD SET
1/2 MT
CHROME

FRAME SIZE -
H - 60cm
(ADJUSTABLE)
W - 32cm

(B-22)

COSMOPOLITAN
2/LT PND CHROME
1/2 MT DROP/20cm ARM
W -
COSMOPOLITAN
GLASS & CHROME PLATES

FRAME SIZE -
H - 65cm (ADJUSTABLE)
W - 72cm

(B-22)

NOTE -
PENDANTS AVAILABLE
1/2 MT
OR
1MT
SQUARE DROP.
THEY
CAN BE SHORTENED
BUT
NOT EXTENDED

ART DECO
DESIGN

COSMOPOLITAN
1/LT W/B
CHROME
W -
COSMOPOLITAN
GLASS & CHROME PLATES

FRAME SIZE -
H - 18cm W - 16cm
P - 26cm

(B-22)



COSMOPOLITAN
4/LT PND CHROME
1/2 MT DROP/20cm ARM
W -
COSMOPOLITAN
GLASS & CHROME PLATES

FRAME SIZE -
H - 65cm (ADJUSTABLE) W - 72cm

(B-22)

Lighting Inspirations

By - Lode International - Circa 1965 -



Globe Required

Provincial Chandelier Range

(B-15) (B-22) (E-14) (E-27)

PROVINCIAL
3LT PND
ANTIQU
WHITE

FRAME SIZE -
H - 63cm W - 45cm

(E14)

PROVINCIAL
8LT WAISTED SHADE PND
ANTIQU WHITE

FRAME SIZE -
H - 91cm W - 89cm

(E14)

- OPTIONAL -
CLIP ON
WAISTED
MATERIAL SHADE

PROVINCIAL
5LT PND
ANTIQU
WHITE

FRAME SIZE -
H - 76cm W - 65cm

(E14)

* SUPPLIED *
WITH
1
METER
CHAIN

**FRENCH
PROVINCIAL
STYLE**

**QUALITY
CRYSTAL
DROPS**

PROVINCIAL
8LT PND
ANTIQU WHITE

FRAME SIZE -
H - 91cm W - 82cm

(E14)

PROVINCIAL
1/1T W/B
ANTIQU WHITE

FRAME SIZE -
H - 35cm W - 12cm
P - 23cm

(E14)



Lighting Inspirations

By - *Lode International* - Circa 1965 -



Globe Required

Versailles Chandelier Range

B-15 B-22 E-14 E-27

**QUALITY
CRYSTAL
DROPS**

* SUPPLIED *
WITH
1/2
METER
CHAIN
&
CANOPY

VERSAILLES
5/LT
CRYSTAL PND

FRAME SIZE -
H - 62cm W - 44cm



E-14

VERSAILLES
1/LT
CRYSTAL W/B

FRAME SIZE -
H - 35cm W - 12cm
P - 18cm

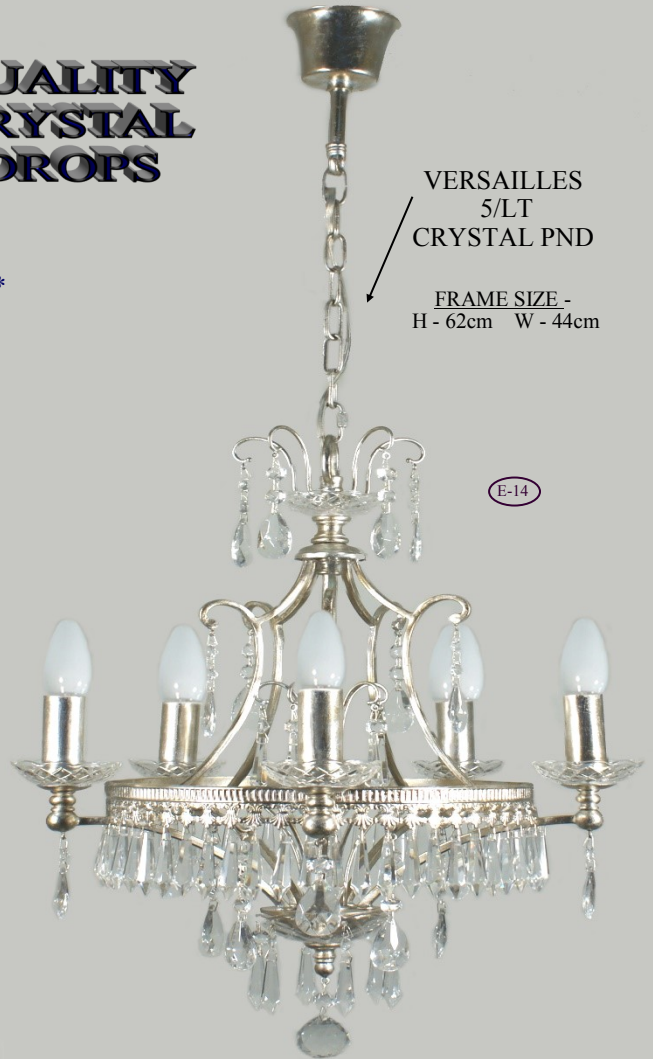

E-14



E-14

VERSAILLES
8/LT
CRYSTAL PND

FRAME SIZE -
H - 75cm W - 67cm

**- FEATURING -
ANTIQUE
SILVER
FRAME
WITH
CRYSTAL
DROPS**

Lighting Inspirations

By - *Lode International* - Circa 1965 -



Globe Required

B-15 B-22 E-14 E-27

Queen Victoria Range

CRYSTAL DROPS

QUEEN VICTORIA
5/LT PENDANT
A/B

FRAME SIZE
H - 80cm W - 53cm

E-14

QUEEN VICTORIA
24/LT PENDANT
A/B

FRAME SIZE
H - 150cm W - 104cm

E-14

QUALITY CRYSTAL DROPS

QUEEN VICTORIA
8/LT PEND
A/B

FRAME SIZE
H - 96cm W - 74cm

E-14

* SUPPLIED *
WITH
1
METER
CHAIN

QUEEN VICTORIA
1/LT W/B
A/B

FRAME SIZE
H - 48cm
W - 18cm
P - 22cm

E-14

QUEEN VICTORIA
1/LT
PENDANT
ANTIQUE
BRASS

FRAME SIZE
H - 46cm
W - 25cm

E-27

E-14

QUEEN VICTORIA
2/LT W/B
A/B

FRAME SIZE
H - 48cm
W - 30cm
P - 18cm

**-OPTIONAL-
CANDLE COVERS**

STANDARD - ANTIQUE - MATT
ANTIQUE WHITE WHITE

QUEEN VICTORIA
1/LT FLUSH
ANTIQUE
BRASS

FRAME SIZE
H - 42cm W - 25cm

E-27



Lighting Inspirations

By - *Lode International* - Circa 1965 -



Globe Required

(B-15) (B-22) (E-14) (E-27)

Memphis Range

- OPTIONAL - CANDLE COVERS



STANDARD - ANTIQUE - MATT
ANTIQUE WHITE WHITE

* SUPPLIED *
WITH
1
METER
CHAIN

MEMPHIS
5/LT PND
ANTIQUE
BRASS

FRAME SIZE -
H - 80cm
W - 60 cm

(E-14)

MEMPHIS
12/LT (8 + 4) PENDANT
ANTIQUE BRASS

FRAME SIZE -
H - 135cm W - 110cm

(E-14)

CRYSTAL
DROPS

MEMPHIS
9/LT (6 + 3)
PENDANT
ANTIQUE
BRASS

FRAME SIZE -
H - 90cm
W - 78 cm

(E-14)

MEMPHIS
1/LT W/B
ANTIQUE
BRASS

FRAME SIZE
H - 48cm W - 12cm
P - 21cm

(E-14)

- OPTIONAL -
CLIP ON
WAISTED
MATERIAL SHADE



MEMPHIS
3/LT PND
ANTIQUE
BRASS

FRAME SIZE -
H - 73cm
W - 51 cm

(E-14)

QUALITY
CRYSTAL
DROPS

LARGE
CRYSTAL DROPS
H - 14cm W - 7cm

Lighting Inspirations

By - Lode International - Circa 1965 -



Globe Required

B-15 B-22 E-14 E-27

Angelique Range



ANGELIQUE
5LT PND
ANTIQUe SILVER

FRAME SIZE -
H - 74cm W - 63cm

E-14



- OPTIONAL -
CLIP ON
WAISTED
MATERIAL SHADE



ANGELIQUE
2LT W/B
ANTIQUe SILVER

FRAME SIZE -
H - 42cm W - 32cm
P - 18cm

E-14



ANGELIQUE
3LT PND
ANTIQUe
SILVER

FRAME SIZE -
H - 65cm
W - 43cm

E-14

LARGE
CRYSTAL
DROPS
H - 10cm
W - 7cm
6/LT

QUALITY
CRYSTAL
DROPS

ANGELIQUE
6LT PND
ANTIQUe SILVER

FRAME SIZE -
H - 92cm W - 72cm

E-14

* SUPPLIED *
WITH
1
METER
CHAIN

Lighting Inspirations

By - Lode International - Circa 1965 -



Globe Required

B-15 B-22 E-14 E-27

Louis 15th Range



LOUIS 15th
5LT PND
BRONZE

FRAME SIZE -
H - 74cm W - 63cm

E-14

- OPTIONAL -
CLIP ON
WAISTED
MATERIAL SHADE



LOUIS 15th
2LT W/B BRONZE

FRAME SIZE -
H - 43cm W - 34cm
P - 19cm

E-14



LOUIS 15th
3LT PND
BRONZE

FRAME SIZE -
H - 70cm
W - 45cm

E-14

LARGE
CRYSTAL
DROPS
H - 10cm
W - 7cm
6/LT

QUALITY
CRYSTAL
DROPS



LOUIS 15th
6LT PND BRONZE

FRAME SIZE -
H - 93cm W - 72cm

E-14

* SUPPLIED *
WITH
1
METER
CHAIN

Lighting Inspirations

By - *Lode International* - Circa 1965 -



Globe Required

B-15 B-22 E-14 E-27

Le Bastille Basket Chandelier Range

**QUALITY
CRYSTAL
DROPS**

** SUPPLIED *
WITH
1/2
METER
CHAIN
&
CANOPY*

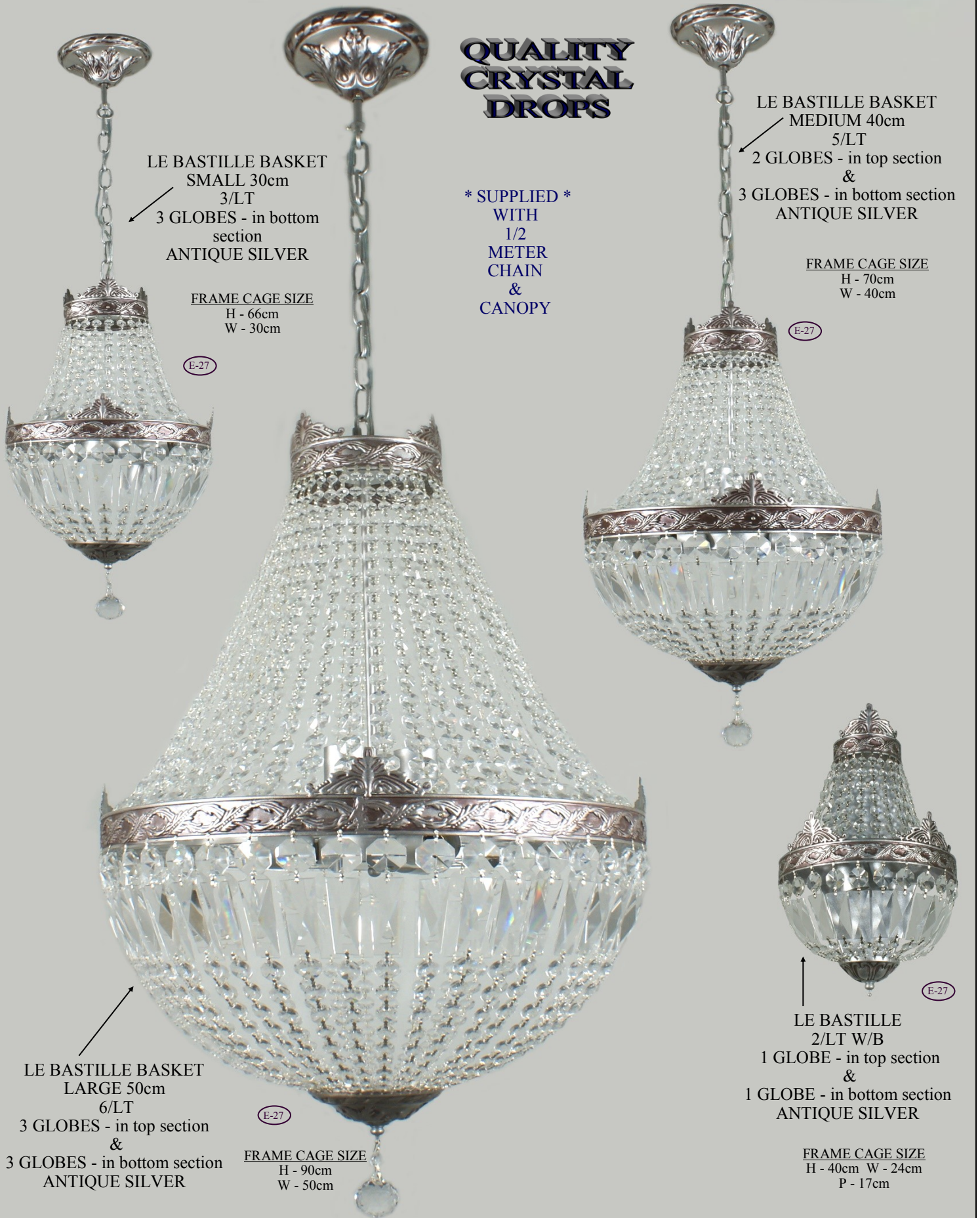

LE BASTILLE BASKET
SMALL 30cm
3/LT
3 GLOBES - in bottom
section
ANTIQUÉ SILVER

FRAME CAGE SIZE
H - 66cm
W - 30cm

E-27

LE BASTILLE BASKET
MEDIUM 40cm
5/LT
2 GLOBES - in top section
&
3 GLOBES - in bottom section
ANTIQUÉ SILVER

FRAME CAGE SIZE
H - 70cm
W - 40cm

E-27

LE BASTILLE BASKET
LARGE 50cm
6/LT
3 GLOBES - in top section
&
3 GLOBES - in bottom section
ANTIQUÉ SILVER

FRAME CAGE SIZE
H - 90cm
W - 50cm

E-27

LE BASTILLE
2/LT W/B
1 GLOBE - in top section
&
1 GLOBE - in bottom section
ANTIQUÉ SILVER

FRAME CAGE SIZE
H - 40cm W - 24cm
P - 17cm

E-27

Lighting Inspirations

By - *Lode International - Circa 1965 -*



Globe Required

B-15 B-22 E-14 E-27

Le Maison Basket Chandelier Range

**QUALITY
CRYSTAL
DROPS**

LE MAISON BASKET
SMALL 30cm
3/LT - in middle section
ANTIQUÉ SILVER

FRAME CAGE SIZE
H - 66cm W - 30cm

E-27



LE MAISON BASKET
MEDIUM 40cm
5/LT
2 GLOBES
- in top section
&
3 GLOBES
- in bottom section
ANTIQUÉ SILVER

FRAME CAGE SIZE
H - 70cm W - 40cm

E-27



E-27

LE MAISON
2/LT W/B
1 GLOBE - in top
section
&
1 GLOBE - in bottom
section
ANTIQUÉ SILVER

FRAME CAGE SIZE
H - 45cm W - 25cm
P - 16cm



LE MAISON BASKET
LARGE 50cm
6/LT
3 GLOBES - in top section
&
3 GLOBES - in bottom section
ANTIQUÉ SILVER

E-27

FRAME CAGE SIZE -
H - 90cm W - 50cm

* SUPPLIED *
WITH
1/2
METER
CHAIN
&
CANOPY

Lighting Inspirations

By - *Lode International* - Circa 1965 -



Globe Required

B-15 B-22 E-14 E-27

Le Pavillon Chrome Range



LE PAVILLON FLUSH 40cm
LARGE 3/LT CHROME

E-27

FRAME SIZE -
H - 23cm W - 41cm



LE PAVILLON FLUSH 25cm
SMALL 3/LT CHROME

E-27

FRAME SIZE -
H - 20cm W - 25cm

**QUALITY
CRYSTAL
DROPS**



LE PAVILLON 2/LT
WALL BRACKET CHROME

E-27

FRAME SIZE -
H - 41cm W - 25cm
P - 17cm



**- FEATURING -
UNIQUE
GLASS CANOPY
COVER
&
GLASS TOP
FRAME COVER**

LE PAVILLON
BASKET SMALL 30cm
3/LT
CHROME

E-27

FRAME SIZE -
H - 48cm W - 30cm



LE PAVILLON
BASKET LARGE 40cm
5/LT
CHROME

E-27

FRAME SIZE -
H - 68cm W - 41cm

Lighting Inspirations

By - Lode International - Circa 1965 -



Globe Required

Le Pavillon Antique Brass Range

B-15 B-22 E-14 E-27



LE PAVILLON FLUSH 40cm
LARGE 3/LT ANTIQUE BRASS

E-27

FRAME SIZE -
H - 23cm W - 41cm



LE PAVILLON FLUSH 25cm
SMALL 3/LT ANTIQUE BRASS

E-27

FRAME SIZE -
H - 20cm W - 25cm

**QUALITY
CRYSTAL
DROPS**



LE PAVILLON 2/LT
WALL BRACKET A/B

E-27

FRAME SIZE -
H - 41cm W - 25cm
P - 17cm



LE PAVILLON
BASKET SMALL 30cm
3/LT
ANTIQUE BRASS

E-27

FRAME SIZE -
H - 48cm W - 30cm

LE PAVILLON
BASKET LARGE 40cm
5/LT
ANTIQUE BRASS

E-27

FRAME SIZE -
H - 68cm W - 41cm

Lighting Inspirations

By - Lode International - Circa 1965 -



Globe Required

B-15 B-22 E-14 E-27

Quadrato Chandelier Range

QUADRATO
PENDANT 5LT
MEDIUM 40cm
CHROME
FRAME SIZE
H - 17cm
W - 40cm
ADD CABLE
SUSPENSION
70cm

E-14

**NEW
PRODUCT**

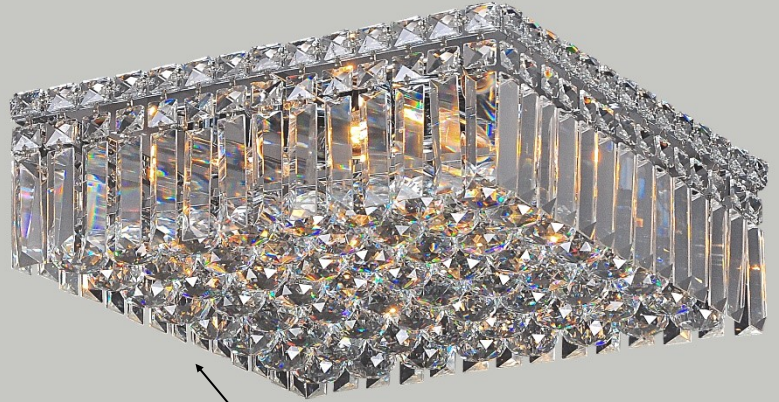

QUADRATO
FLUSH 6LT
LARGE 50cm
CHROME
FRAME SIZE
H - 17cm
W - 50cm

E-14

**NEW
PRODUCT**

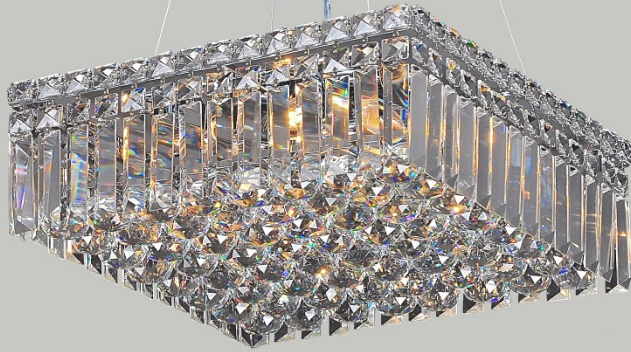

QUADRATO
FLUSH 5LT
MEDIUM 40cm
CHROME
FRAME SIZE
H - 17cm
W - 40cm

E-14

**HIGH
QUALITY
CRYSTAL
DROPS**

QUADRATO
PENDANT 6LT
LARGE 50cm
CHROME
FRAME SIZE
H - 17cm
W - 50cm
ADD CABLE
SUSPENSION
70cm

E-14

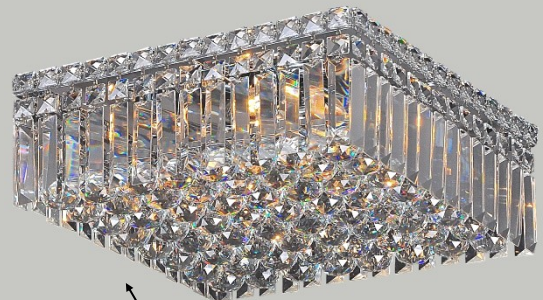

QUADRATO
FLUSH 4LT
SMALL 30cm
CHROME
FRAME SIZE
H - 17cm
W - 30cm

E-14

**NEW
PRODUCT**

Lighting Inspirations

By - Lode International - Circa 1965 -



Globe Required

Rotondo Chandelier Range

(B-15) (B-22) (E-14) (E-27)

ROTONDO
PENDANT 5LT
MEDIUM 40cm
CHROME
FRAME SIZE
H - 17cm
W - 40cm
ADD CABLE
SUSPENSION
70cm

**NEW
PRODUCT**

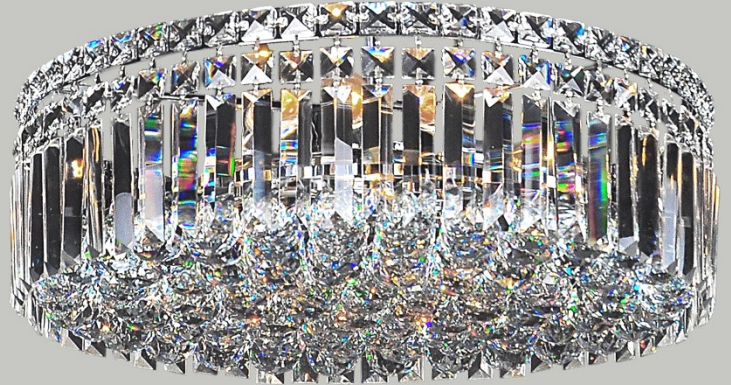

ROTONDO
FLUSH 6LT
LARGE 50cm
CHROME
FRAME SIZE
H - 17cm
W - 50cm

**NEW
PRODUCT**

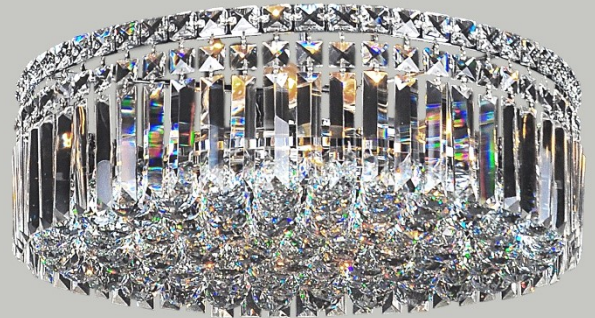
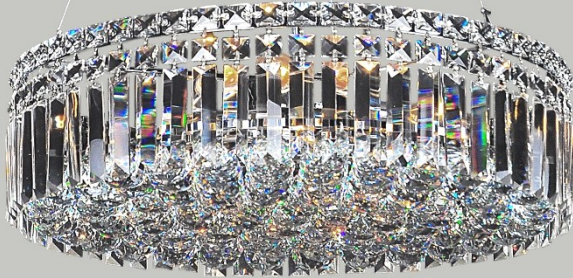

**HIGH
QUALITY
CRYSTAL
DROPS**

ROTONDO
PENDANT 6LT
LARGE 50cm
CHROME
FRAME SIZE
H - 17cm
W - 50cm
ADD CABLE
SUSPENSION
70cm

ROTONDO
FLUSH 5LT
MEDIUM 40cm
CHROME
FRAME SIZE
H - 17cm
W - 40cm

(E-14)

(E-14)



**NEW
PRODUCT**

ROTONDO
FLUSH 3LT
SMALL 30cm
CHROME
FRAME SIZE
H - 17cm
W - 30cm

(E-14)

Lighting Inspirations

By - Lode International - Circa 1965 -



Globe Required

B-15 B-22 E-14 E-27

Classique Chandelier Range

**HIGH
QUALITY
CRYSTAL
DROPS**

CLASSIQUE
BASKET 5LT
MEDIUM 40cm
CHROME
FRAME SIZE
H - 68cm
W - 40cm

E-14



* SUPPLIED *
WITH
1/2
METER
CHAIN
&
CANOPY

**NEW
PRODUCT**



E-14

CLASSIQUE
FLUSH 6LT
LARGE 50cm
CHROME
FRAME SIZE
H - 17cm
W - 50cm

**NEW
PRODUCT**



CLASSIQUE
BASKET 6LT
LARGE 50cm
CHROME
FRAME SIZE
H - 71cm
W - 50cm

E-14



E-14

CLASSIQUE
FLUSH 5LT
MEDIUM 40cm
CHROME
FRAME SIZE
H - 17cm
W - 40cm

**NEW
PRODUCT**



E-14

CLASSIQUE
FLUSH 3LT
SMALL 30cm
CHROME
FRAME SIZE
H - 17cm
W - 30cm

Lighting Inspirations

By - *Lode International* - Circa 1965 -



Globe Required

B-15 B-22 E-14 E-27

Crystal Chandelier Basket Ranges

MOZART
1/LT
CRYSTAL
BASKET
CHROME

FRAME
SIZE

H - 53cm
W - 28cm
+
1/2 METER
CHAIN
&
CANOPY

**- FEATURING -
ALL
GLASS BOWLS
WITH
CRYSTAL DROPS**

CHOPIN
1/LT
CRYSTAL
BASKET
CROME

FRAME
SIZE

H - 40cm
W - 24cm
+
1/2 METER
CHAIN
&
CANOPY

E-27

E-27

**QUALITY
CRYSTAL
DROPS**

Lighting Inspirations

By - *Lode International* - Circa 1965 -



Globe Required

B-15 B-22 E-14 E-27

Vienna Chandelier Range

VIENNA 8/LT CHANDELIER

FRAME SIZE
H - 48cm
W - 55cm

**- OPTIONAL -
CANDLE COVER
AVAILABLE IN
MATT WHITE.
AN EXTRA
CHARGE IS
APPLICABLE**



VIENNA 1/LT W/B

FRAME SIZE
H - 23cm W - 22cm
P - 23cm

VIENNA 3/LT CHANDELIER

FRAME SIZE
H - 49cm
W - 46cm

**- FEATURING -
CRYSTAL DROPS
&
GLASS ARMS**

VIENNA 5/LT CHANDELIER

FRAME SIZE
H - 49cm W - 46cm



VIENNA 9/LT =
6 + 3/LT
CHANDELIER

FRAME SIZE
H - 65cm W - 66cm

**QUALITY
CRYSTAL
DROPS**

* SUPPLIED *
WITH
1/2
METER CHAIN
&
CANOPY

VIENNA 12/LT
=
8/LT + 4/LT
CRYSTAL CHANDELIER

FRAME SIZE
ONLY
H - 55cm W - 80cm

Lighting Inspirations

By - Lode International - Circa 1965 -



Globe Required

B-15 B-22 E-14 E-27

Walzer Chandelier Range

WALZER
5/LT
CRYSTAL
CHANDELIER

FRAME SIZE
H - 64cm W - 58cm

**- FEATURING -
HIGH QUALITY
CRYSTAL DROPS
&
GLASS ARMS**

E14

WALZER
2/LT W/B
CRYSTAL
WALL BRACKET

FRAME SIZE
H - 36cm W - 34cm
P - 17cm

E14

**NEW
PRODUCT**

* SUPPLIED *
WITH
1/2
METER
CHAIN

**QUALITY
CRYSTAL
DROPS**

WALZER
8/LT
CRYSTAL
CHANDELIER

E14

FRAME SIZE
H - 64cm W - 56cm



Lighting Inspirations

By - Lode International - Circa 1965 -



Globe Required

B-15 B-22 E-14 E-27

Danielle Chandelier Range

**QUALITY
CRYSTAL
DROPS**

DANIELLE
3/LT + 1/LT PND

FRAME SIZE -
H - 47cm W - 47cm

E-14

* SUPPLIED *
WITH
1/2
METER
CHAIN
&
CANOPY

DANIELLE
BASKET 2/LT

FRAME SIZE -
H - 47cm W - 28cm

E-14

**QUALITY
CRYSTAL
DROPS**

E-14

DANIELLE
1/LT W/B

FRAME SIZE -
H - 37cm W - 12cm P - 27cm

E-14

DANIELLE
6/LT + 3/LT PND

FRAME SIZE -
H - 54cm W - 64cm



Lighting Inspirations



By - *Lode International* - Circa 1965 -

Globe Required

Marie Therese Antique Brass & Chrome Range

B-15 B-22 E-14 E-27



**-OPTIONAL-
PLEATED MATERIAL
SHADES**

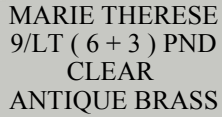

* SUPPLIED *
WITH
1/2 MT
METER
CHAIN

CRYSTAL
DROPS



FRAME SIZE -
H - 40cm W - 45cm

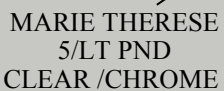

* SUPPLIED *
WITH
1/2 MT
METER
CHAIN

NEW STOCK
E14

Lighting Inspirations

By - *Lode International* - Circa 1965 -



Globe Required

Juliette Antique Brass Chandelier Range

(B-15) (B-22) (E-14) (E-27)

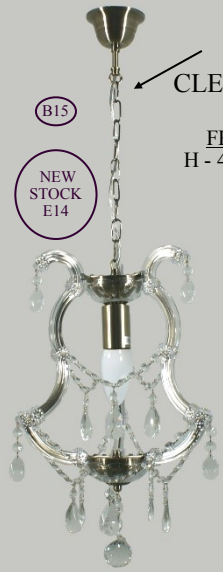

JULIETTE
1/LT PND
CLEAR / ANT-BRS

FRAME SIZE -
H - 49cm W - 27cm

(B15)

NEW STOCK
E14



JULIETTE
3/LT PND
CLEAR
ANT-BRS

FRAME SIZE -
H - 60cm
W - 50cm

NEW STOCK
E14

(B15)



JULIETTE
8/LT PND
CLEAR /ANT-BRS

FRAME SIZE -
H - 66cm W - 70cm

* SUPPLIED *
WITH
1/2 MT
METER
CHAIN

(B15)

NEW STOCK
E14



JULIETTE
5/LT PND
CLEAR ANT-BRS

FRAME SIZE -
H - 62cm W - 55cm

(B15)

NEW STOCK
E14

* SUPPLIED *
WITH
1/2 MT
METER
CHAIN

**- OPTIONAL -
PLEATED MATERIAL
SHADES**

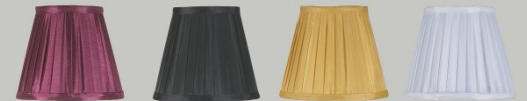

JULIETTE
12/LT PND
CLEAR / ANT-BRS

FRAME SIZE -
H - 76cm W - 89cm

(B15)

NEW STOCK
E14

JULIETTE
1/LT W/B
CLEAR / ANT-BRS

FRAME SIZE -
H - 37cm W - 12cm P - 27cm

NEW STOCK
E14

(B15)



Lighting Inspirations

By - *Lode International* - Circa 1965 -



Globe Required

Juliette Chrome Chandelier Range

B-15 B-22 E-14 E-27

Also Available In → BLUE PINK GREEN



JULIETTE
1/LT PND
CLEAR /CHROME

FRAME SIZE -
H - 49cm W - 27cm

B15

NEW STOCK
E14



JULIETTE
3/LT PND
CLEAR
CHROME

FRAME SIZE -
H - 60cm
W - 50cm

B15

NEW STOCK
E14



JULIETTE
5/LT PND
CLEAR
CHROME

FRAME SIZE -
H - 62cm W - 55cm

B15

NEW STOCK
E14



JULIETTE
12/LT PND
CLEAR /CHROME

FRAME SIZE -
H - 76cm W - 89cm

B15

NEW STOCK
E14



* SUPPLIED *
WITH
1/2 MT
METER
CHAIN



JULIETTE
8/LT PND
CLEAR /CHROME

FRAME SIZE -
H - 66cm W - 70cm

B15

NEW STOCK
E14

- OPTIONAL -
PLEATED MATERIAL
SHADES

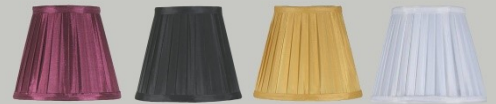

B15

NEW STOCK
E14

JULIETTE
1/LT W/B
CLEAR /CHROME

FRAME SIZE -
H - 37cm W - 12cm P - 27cm

Lighting Inspirations

By - *Lode International - Circa 1965 -*



Globe Required

Houston Chrome Range

(B-15) (B-22) (E-14) (E-27)

* SUPPLIED *
WITH
1
METER
CHAIN

**OPAL
MATT
GLASSWARE**



HOUSTON CHROME
SINGLE SUSPENSION
2/LT

FRAME SIZE -
H - 57cm W - 33cm



HOUSTON CHROME
3/LT PND

FRAME SIZE -
H - 49cm W - 44cm



HOUSTON
CHR 5/LT
PND FLUSH

FRAME SIZE -
H - 59cm W - 58cm



HOUSTON CHR 3/LT PND FLUSH

FRAME SIZE -
H - 49cm W - 44cm



HOUSTON CHROME
5/LT PND

FRAME SIZE -
H - 59cm W - 58cm



HOUSTON CHROME
6+3
= 9/LT PND

FRAME SIZE -
H - 76cm W - 66cm



HOUSTON CHROME
SEMI FLUSH
2/LT

FRAME SIZE -
H - 39cm W - 33cm

HOUSTON CHROME
1/LT W/B

FRAME SIZE
H - 23cm W - 18cm
P - 24cm

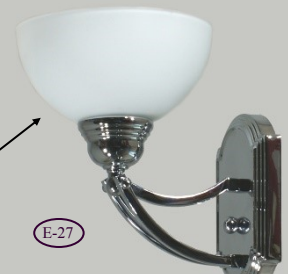

Lighting Inspirations

By - *Lode International* - Circa 1965 -



Globe Required

Houston Bronze Range

B-15 B-22 E-14 E-27

* SUPPLIED *
WITH
1
METER
CHAIN

**OPAL
MATT
GLASSWARE**



HOUSTON BRONZE
SINGLE SUSPENSION
2/LT

FRAME SIZE -
H - 57cm W - 33cm

E-27

E-27



HOUSTON BRONZE
3/LT PND

FRAME SIZE -
H - 49cm W - 44cm

E-27



HOUSTON BRONZE 3/LT PND FLUSH

FRAME SIZE -
H - 49cm W - 44cm

E-27

HOUSTON
BRONZE 5/LT
PND FLUSH

FRAME SIZE -
H - 59cm W - 58cm

E-27

E-27



HOUSTON BRONZE
5/LT PND

FRAME SIZE -
H - 59cm W - 58cm

E-27



HOUSTON BRONZE
6+3 =
9/LT PND

FRAME SIZE -
H - 76cm W - 66cm

E-27



HOUSTON BRONZE
SEMI FLUSH
2/LT

FRAME SIZE -
H - 39cm W - 33cm

E-27

HOUSTON BRONZE
1/LT W/B

FRAME SIZE
H - 23cm W - 18cm
P - 24cm

E-27



Lighting Inspirations

By - *Lode International* - Circa 1965 -



Globe Required

Baltimore Bronze Range

B-15 B-22 E-14 E-27



E27

BALTIMORE
W/B 1/LT BRONZE

FRAME SIZE -
H - 24cm W - 16cm
P - 20cm



E27

BALTIMORE
5/LT + 1/LT PND
BRONZE

FRAME SIZE -
H - 74cm W - 70cm



E27

BALTIMORE
SEMI FLUSH 1/LT
BRONZE

FRAME SIZE -
H - 38cm W - 33cm

* SUPPLIED *
WITH
1
METER
CHAIN

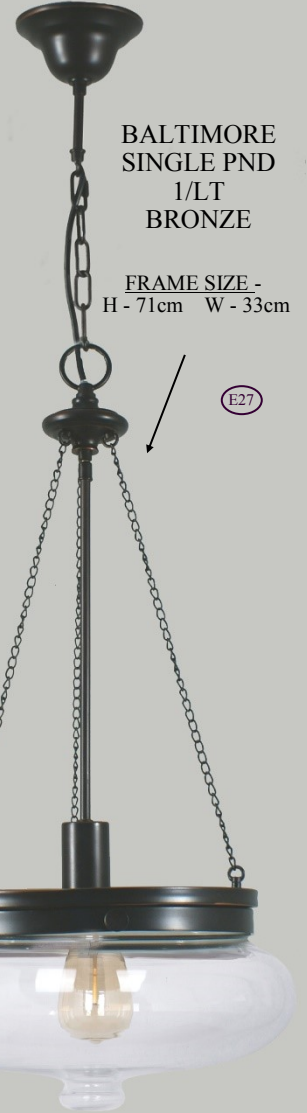

BALTIMORE
SINGLE PND
1/LT
BRONZE

FRAME SIZE -
H - 71cm W - 33cm

E27



E27

BALTIMORE
OYSTER 1/LT
BRONZE

FRAME SIZE -
H - 21cm W - 36cm

Lighting Inspirations

By - Lode International - Circa 1965 -



Globe Required

B-15 B-22 E-14 E-27

Baltimore Nickel Range



E27

BALTIMORE
W/B 1/LT NICKEL

FRAME SIZE -
H - 24cm W - 16cm
P - 20cm



E27



E27

BALTIMORE
SEMI FLUSH 1/LT
NICKEL

FRAME SIZE -
H - 38cm W - 33cm



BALTIMORE
SINGLE PND
1/LT
NICKEL

FRAME SIZE -
H - 71cm W - 33cm

E27

* SUPPLIED *
WITH
1
METER
CHAIN



E27

BALTIMORE
5/LT + 1/LT PND
NICKEL

FRAME SIZE -
H - 74cm W - 70cm

E27

BALTIMORE
OYSTER 1/LT
NICKEL

FRAME SIZE -
H - 21cm W - 36cm



Lighting Inspirations

By - Lode International - Circa 1965 -



Globe Required

B-15 B-22 E-14 E-27

Waldorf Range

WALDORF SEMI FLUSH 3/LT
E27
FRAME SIZE -
H - 32cm W - 38cm

WALDORF OYSTER 3/LT
E27
FRAME SIZE -
H - 20cm W - 38cm

WALDORF SINGLE PENDANT 3/LT
FRAME SIZE -
H - 55cm W - 38cm
* SUPPLIED *
WITH
1
METER
CHAIN

WALDORF 4/LT PENDANT
E27
FRAME SIZE -
H - 59cm W - 50cm

WALDORF 1/LT W/B
E27
FRAME SIZE
H - 23cm W - 15cm
P - 18cm

WALDORF Close up view

WALDORF Close up view on a different angle

ART DECO DESIGN
E27

* SUPPLIED *
WITH
1
METER
CHAIN

Lighting Inspirations

By - Lode International - Circa 1965 -



Globe Required

B-15 B-22 E-14 E-27

Carlylie Range

CARLYLIE SINGLE SUSPENSION 4/LT
 FRAME SIZE WITH OUT CHAIN
 H - 58cm W - 53cm
 * SUPPLIED * WITH 1 METER CHAIN

CARLYLIE SEMI FLUSH 3/LT
 FRAME SIZE -
 H - 34cm W - 43cm

CARLYLIE 4/LT PENDANT
 FRAME SIZE WITH OUT ROD -
 H - 48cm W - 58cm

CARLYLIE 6/LT PENDANT
 FRAME SIZE WITH OUT ROD -
 H - 55cm W - 70cm

CARLYLIE 1/LT WALL BRACKET
 FRAME SIZE -
 H - 38cm W - 15cm
 P - 20cm

NEW PRODUCT

NEW PRODUCT

OPAL MATT GLASSWARE

75mm

3 x 300mm +
 1 x 150mm +
 1 x 75mm

NOTE -
 ROD SYSTEM SAME AS 6/LT

Lighting Inspirations

By - *Lode International* - Circa 1965 -



Globe Required

B-15 B-22 E-14 E-27

New Jersey Range

NEW JERSEY
5/LT PND

FRAME SIZE -
H - 73cm
W - 65cm

E-27

NEW JERSEY
5/LT PND
FLUSH

E-27

NEW JERSEY
2/LT →
BENCH PND

FRAME SIZE -
H - 53cm W - 93cm

E-27



E-27

NEW JERSEY
SEMI FLUSH 3/LT

FRAME SIZE -
H - 31cm W - 45cm

NEW JERSEY
6+3 = 9/LT PND

FRAME SIZE -
H - 98cm W - 75cm

E-27

- FEATURING -
ORIGINAL
TORTOISE
SHELL
GLASSWARE

* SUPPLIED *
WITH
1
METER
CHAIN

NEW
JERSEY
3/LT PND

FRAME SIZE -
H - 65cm
W - 48cm

NEW JERSEY
3/LT PND
FLUSH



E-27

NEW JERSEY
1/LT W/B →

FRAME SIZE
H - 43cm W - 16cm
P - 25cm



NEW JERSEY
SINGLE SUSP 3/LT

FRAME SIZE -
H - 75cm W - 55cm

NEW JERSEY
OYSTER 3/LT

FRAME SIZE -
H - 19cm W - 39cm



E-27



E-27

Lighting Inspirations

By - *Lode International* - Circa 1965 -



Globe Required

B-15 B-22 E-14 E-27

New York Range



NEW YORK
5/LT PND

FRAME SIZE -
H - 73cm
W - 65cm

NEW YORK
5/LT PND
FLUSH



NEW YORK
2/LT
BENCH PND

FRAME SIZE -
H - 53cm W - 93cm



NEW YORK
SEMI FLUSH 3/LT

FRAME SIZE -
H - 31cm W - 45cm

E-27

**- FEATURING -
ORIGINAL
TORTOISE
SHELL
GLASSWARE**

NEW YORK
6+3 = 9/LT PND

FRAME SIZE -
H - 98cm W - 75cm

* SUPPLIED *
WITH
1
METER
CHAIN



NEW
YORK
3/LT PND

FRAME SIZE -
H - 65cm
W - 48cm

NEW YORK
3/LT PND
FLUSH



NEW YORK
SINGLE SUSP 3/LT

FRAME SIZE -
H - 75cm W - 55cm

NEW YORK
1/LT W/B

FRAME SIZE
H - 43cm W - 16cm
P - 25cm

NEW YORK
OYSTER 3/LT

FRAME SIZE -
H - 19cm W - 39cm



Lighting Inspirations

By - Lode International - Circa 1965 -



Globe Required

3030 Classical Range

(B-15) (B-22) (E-14) (E-27)

3030 5/LT PND
FRAME SIZE -
H - 68cm
W - 62cm
(E-27)

3030 5/LT PND FLUSH
(E-27)

3030 2 TIER
6+3 =
9/LT PND
FRAME SIZE -
H - 78cm
W - 74cm
(E-27)

3030 OYSTER 3/LT
FRAME SIZE
H - 19cm W - 39cm
(E-27)

3030 2 TIER
8+4 =
12/LT PND
FRAME SIZE -
H - 93cm W - 90cm
(E-27)

3030 SEMI FLUSH 3/LT
FRAME SIZE -
H - 38cm W - 41cm
(E-27)

3030 3/LT PND FLUSH
(E-27)

3030 3/LT PND
FRAME SIZE -
H - 60cm
W - 53cm
(E-27)

3030 1/LT W/B
FRAME SIZE
H - 40cm
W - 16cm
P - 21cm
(E-27)

3030 3 TIER
10+5+5 =
20/LT PND
FRAME SIZE -
H - 158cm W - 138cm
(E-27)

3030 SINGLE SUSP 3/LT
FRAME SIZE -
H - 63cm W - 41cm
(E-27)

*** SUPPLIED *
WITH
1
METER
CHAIN**

*** SUPPLIED *
WITH
1
METER
CHAIN
&
STEEL
CABLE
SUPPORT**

**FEATURING
ORIGINAL
TORTOISE
SHELL
GLASSWARE**

Lighting Inspirations

By - Lode International - Circa 1965 -



Globe Required

2020 Classical Range

B-15 B-22 E-14 E-27

2020 5/LT PND
FRAME SIZE -
H - 68cm
W - 62cm

2020 5/LT PND FLUSH

2020 6+3 = 9/LT PND
FRAME SIZE -
H - 78cm
W - 74cm

2020 OYSTER 3/LT
FRAME SIZE
H - 19cm W - 39cm

2020 2 TIER 8+4 = 12/LT PND
FRAME SIZE -
H - 93cm W - 90cm

2020 SEMI FLUSH 3/LT
FRAME SIZE -
H - 38cm W - 41cm

2020 3/LT PND
FRAME SIZE -
H - 60cm
W - 53cm

2020 3/LT PND FLUSH

2020 1/LT W/B
FRAME SIZE
H - 40cm
W - 16cm
P - 21cm

2020 3 TIER 10+5+5 = 20/LT PND
FRAME SIZE -
H - 158cm W - 138cm

2020 SINGLE SUSP 3/LT
FRAME SIZE -
H - 63cm W - 41cm

*** SUPPLIED * WITH 1 METER CHAIN**

*** SUPPLIED * WITH 1 METER CHAIN & STEEL CABLE SUPPORT**

FEATURING ORIGINAL TORTOISE SHELL GLASSWARE

Lighting Inspirations

By - Lode International - Circa 1965 -



Globe Required

B-15 B-22 E-14 E-27

Arterious Range

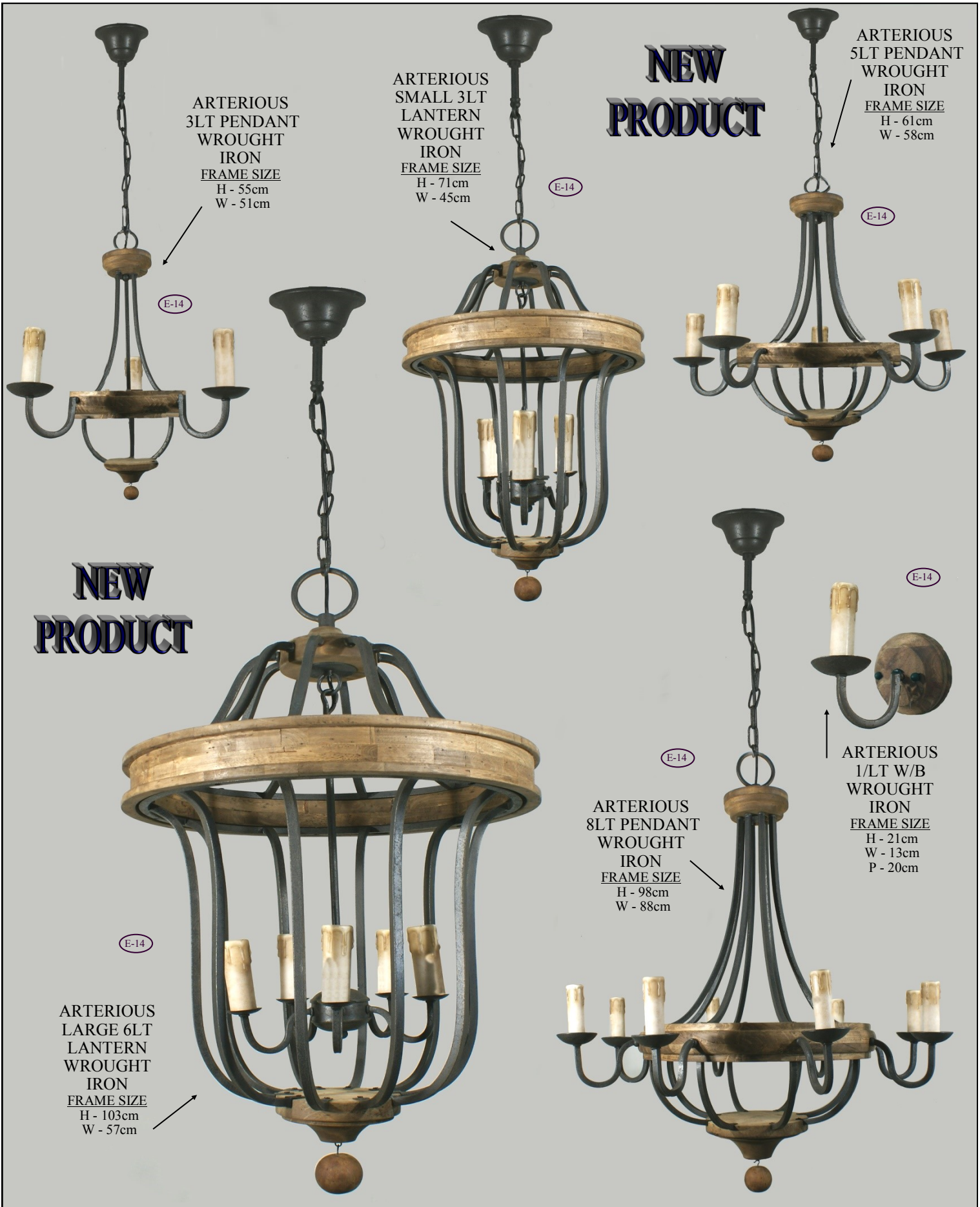

ARTERIOUS
3LT PENDANT
WROUGHT
IRON
FRAME SIZE
H - 55cm
W - 51cm

E-14

ARTERIOUS
SMALL 3LT
LANTERN
WROUGHT
IRON
FRAME SIZE
H - 71cm
W - 45cm

E-14

**NEW
PRODUCT**

ARTERIOUS
5LT PENDANT
WROUGHT
IRON
FRAME SIZE
H - 61cm
W - 58cm

E-14

**NEW
PRODUCT**



E-14

ARTERIOUS
LARGE 6LT
LANTERN
WROUGHT
IRON
FRAME SIZE
H - 103cm
W - 57cm

ARTERIOUS
8LT PENDANT
WROUGHT
IRON
FRAME SIZE
H - 98cm
W - 88cm

E-14



E-14

ARTERIOUS
1/LT W/B
WROUGHT
IRON
FRAME SIZE
H - 21cm
W - 13cm
P - 20cm

Lighting Inspirations

By - *Lode International* - Circa 1965 -



Globe Required

B-15 B-22 E-14 E-27

Semi Flush Oyster Range



Lighting Inspirations

By - Lode International - Circa 1965 -



Globe Required

Quick Reference Exterior W/B Range

B-15 B-22 E-14 E-27



Lighting Inspirations

By - *Lode International* - Circa 1965 -



Globe Required

B-15 B-22 E-14 E-27

Domain Exterior Post Range

<p>DOMAIN POST CAP</p>	<p><u>AVAILABLE POST TOPS</u></p>	<p><u>AVAILABLE POST TOPS</u></p>
<p>DOMAIN POST ANTIQUE BRONZE</p>	 <p>GROVE DOMAIN POST ANTIQUE BRONZE POST TOP H - 62cm W - 29cm INCLUDES DOMAIN POST CAP</p>	 <p>HERITAGE DOMAIN POST ANTIQUE BLACK POST TOP H - 75cm W - 29cm INCLUDES DOMAIN POST CAP</p>
<p>HEIGHT 213cm POST ONLY</p>	<p>DOMAIN POST ANTIQUE BLACK</p>	<p>HEIGHT 213cm POST ONLY</p>
<p>HEAVY DUTY 4 HOLE FLOOR MOUNTING</p>	 <p>ALBANY DOMAIN POST ANTIQUE BRONZE POST TOP H - 65cm W - 30cm INCLUDES DOMAIN POST CAP</p>	 <p>WATERFORD DOMAIN POST ANTIQUE BLACK POST TOP H - 68cm W - 36cm INCLUDES DOMAIN POST CAP</p>
	 <p>FLINDERS DOMAIN POST ANTIQUE BRONZE POST TOP H - 65cm W - 27cm INCLUDES DOMAIN POST CAP</p>	 <p>FLINDERS DOMAIN POST ANTIQUE BLACK POST TOP H - 65cm W - 27cm INCLUDES DOMAIN POST CAP</p>

Lighting Inspirations

By - *Lode International - Circa 1965 -*



Globe Required

B-15 B-22 E-14 E-27

Exterior Rod Pendant Range

MULTIPLE COMBINATION EXTERIOR RODS SUPPLIED WITH ALL BRONZE & ANTIQUE BLACK ROD PENDANTS

Model Name	Material	Pendant Height	Rod Height
ALBANY LARGE ROD PND	ANTIQUE BRONZE	52cm	104cm
GROVE LARGE ROD PND	ANTIQUE BRONZE	49cm	104cm
FLINDERS LARGE ROD PND	ANTIQUE BRONZE	58cm	104cm
CAULFIELD LARGE ROD PND	ANTIQUE BRONZE	42cm	104cm
TOORAK MEDIUM ROD PND	ANTIQUE BRONZE	55cm	50cm
PARADE MEDIUM ROD PND	ANTIQUE BRONZE	27cm	50cm
ELSTERNWICK MEDIUM ROD PND	ANTIQUE BRONZE	42cm	50cm
WELLINGTON LARGE ROD PND	ANTIQUE BLACK	48cm	104cm
WATERFORD LARGE ROD PND	ANTIQUE BLACK	58cm	104cm
FLINDERS LARGE ROD PND	ANTIQUE BLACK	58cm	104cm
HERITAGE LARGE ROD PND	ANTIQUE BLACK	57cm	104cm

Lighting Inspirations

By - Lode International - Circa 1965 -



Globe Required

Albany Exterior Range

B-15 B-22 E-14 E-27

ALBANY LRG EXT W/B BRONZE

FRAME SIZE
H - 70cm
W - 30cm
P - 38cm

ANTIQUE BRONZE

ALBANY LARGE POST TOP ON STANDARD 3 PIECE POST BRONZE

FRAME SIZE
H - 236cm
W - 30cm

POST EXTENSION H - 41cm

*** NOTE ***
SINGLE POSTS ARE SUPPLIED WITH A TOTAL 3 PIECE POST - OPTIONAL POST EXTENSION 4

ALBANY SML EXT W/B BRONZE

FRAME SIZE
H - 53cm W - 22cm
P - 28cm

- NOTE - INTERIOR USE ONLY

FOR EXTERIOR USE GO TO ROD PENDANT PAGE

* SUPPLIED WITH 1/2 METER CHAIN

ALBANY LRG EXT PILLAR MOUNT BRONZE

FRAME SIZE
H - 70cm W - 30cm

ALBANY LRG 1/LT PND BRONZE

FRAME SIZE - H - 60cm W - 30cm

ALBANY EXT WALL SCONCE BRONZE

FRAME SIZE
H - 43cm W - 22cm
P - 12cm

ALBANY SMALL 1/LT ON STANDARD 3 PIECE POST BRONZE

FRAME SIZE
H - 230cm
W - 42cm

I.P RATED 23 & 24

ALBANY SMALL 2/LT ON STANDARD 3 PIECE POST BRONZE

FRAME SIZE
H - 230cm
W - 80cm

*** NOTE ***
MULTI ARM POSTS ARE SUPPLIED WITH A TOTAL 3 PIECE POST - OPTIONAL POST EXTENSION 4

ALBANY SMALL 3/LT ON STANDARD 3 PIECE POST BRONZE

FRAME SIZE
H - 230cm
W - 80cm

*** NOTE ***
MULTI ARM POSTS ARE SUPPLIED WITH A TOTAL 3 PIECE POST - OPTIONAL POST EXTENSION 4

NEW PRODUCT

*** NOTE ***
MULTI ARM POSTS ARE SUPPLIED WITH A TOTAL 3 PIECE POST - OPTIONAL POST EXTENSION 4

Lighting Inspirations

By - Lode International - Circa 1965 -



Globe Required

Wellington Exterior Range

(B-15) (B-22) (E-14) (E-27)

WELLINGTON LRG EXT W/B ANT BLACK

FRAME SIZE
H - 64cm W - 25cm
P - 32cm

WELLINGTON LRG EXT PILLAR MOUNT ANT BLACK

FRAME SIZE
H - 63cm W - 29cm

WELLINGTON LRG CHAIN PND ANT BLACK

FRAME SIZE - H - 52cm W - 28cm

WELLINGTON MED EXT W/B ANT BLACK

FRAME SIZE
H - 53cm W - 20cm
P - 26cm

WELLINGTON SML EXT W/B ANT BLACK

FRAME SIZE
H - 43cm W - 15cm
P - 24cm

WELLINGTON LARGE POST TOP ON STANDARD 3 PIECE POST ANT BLACK

FRAME SIZE
H - 226cm W - 28cm

WELLINGTON MEDIUM 1/LT ON STANDARD 3 PIECE POST ANT BLACK

FRAME SIZE
H - 224cm W - 40cm

WELLINGTON MEDIUM 2/LT ON STANDARD 3 PIECE POST ANT BLACK

FRAME SIZE
H - 224cm W - 72cm

WELLINGTON MEDIUM 3/LT ON STANDARD 3 PIECE POST ANT BLACK

FRAME SIZE
H - 224cm W - 72cm

- NOTE -
FOR INTERIOR USE ONLY

FOR EXTERIOR USE GO TO ROD PENDANT PAGE

* SUPPLIED WITH 1/2 METER CHAIN

POST EXTENSION

1

2

3

4

ANTIQUE BLACK

NEW PRODUCT

LARGE PILLAR MOUNT CAP OPTION

MULTI ARM POSTS ARE SUPPLIED WITH A TOTAL 3 PIECE POST - OPTIONAL POST EXTENSION 4

MULTI ARM POSTS ARE SUPPLIED WITH A TOTAL 3 PIECE POST - OPTIONAL POST EXTENSION 4

MULTI ARM POSTS ARE SUPPLIED WITH A TOTAL 3 PIECE POST - OPTIONAL POST EXTENSION 4

I.P RATED 23 & 24

Lighting Inspirations

By - *Lode International* - Circa 1965 -



Globe Required

Waterford Exterior Range

B-15 B-22 E-14 E-27

**WATERFORD LRG
EXT W/B ANT BLACK**

FRAME SIZE
H - 70cm W - 36cm
P - 42cm

E-27

**WATERFORD
LRG EXT
PILLAR MOUNT
ANT BLACK**

FRAME SIZE
H - 72cm W - 36cm

E-27

**WATERFORD LRG EXT
W/B ANT BLACK**

E-27

**- NOTE -
FOR INTERIOR
USE ONLY**

**FOR EXTERIOR
USE
GO
TO
ROD
PENDANT
PAGE**

*** SUPPLIED *
WITH
1/2
METER
CHAIN**

**WATERFORD MED
EXT W/B
ANT BLACK**

FRAME SIZE
H - 54cm W - 28cm
P - 33cm

E-27

**WATERFORD
CHAIN 1/LT PND
ANT BLACK**

FRAME SIZE -
H - 62cm W - 38cm

E-27

**WATERFORD SML
EXT W/B
ANT BLACK**

FRAME SIZE
H - 45cm W - 23cm
P - 28cm

E-27

**ANTIQUE
BLACK**

**WATERFORD
LARGE
POST TOP
ON
STANDARD
3 PIECE
POST
ANT BLACK**

FRAME SIZE
H - 236cm
W - 38cm

E-27

*** NOTE ***
**LARGE
PILLAR
MOUNT
CAP
OPTION**

*** NOTE ***
**SINGLE
POSTS
ARE
SUPPLIED
WITH
A
TOTAL
3
PIECE
POST
-
OPTIONAL
POST
EXTENSION
4**

**NEW
PRODUCT**

*** NOTE ***
**MULTI ARM
POSTS
ARE
SUPPLIED
WITH
A
TOTAL
3
PIECE
POST
-
OPTIONAL
POST
EXTENSION
4**

**WATERFORD
MEDIUM
1/LT
ON
STANDARD
3 PIECE
POST
ANT BLACK**

FRAME SIZE
H - 230cm
W - 42cm

E-27

**I.P RATED
23 & 24**

**WATERFORD
MEDIUM
2/LT
ON
STANDARD
3 PIECE
POST
ANT BLACK**

FRAME SIZE
H - 230cm
W - 80cm

E-27

*** NOTE ***
**MULTI ARM
POSTS
ARE
SUPPLIED
WITH
A
TOTAL
3
PIECE
POST
-
OPTIONAL
POST
EXTENSION
4**

**WATERFORD
MEDIUM
3/LT
ON
STANDARD
3 PIECE
POST
ANT BLACK**

FRAME SIZE
H - 230cm
W - 80cm

E-27

*** NOTE ***
**MULTI ARM
POSTS
ARE
SUPPLIED
WITH
A
TOTAL
3
PIECE
POST
-
OPTIONAL
POST
EXTENSION
4**

Lighting Inspirations

By - *Lode International* - Circa 1965 -



Globe Required

B-15 B-22 E-14 E-27

Flinders Antique Black Exterior Range

ANTIQUE BLACK

FLINDERS LRG EXT W/B ANT BLACK

FRAME SIZE
H - 78cm
W - 30cm
P - 41cm

FLINDERS MED EXT W/B ANT BLACK

FRAME SIZE
H - 58cm
W - 20cm
P - 30cm

FLINDERS SML EXT W/B ANT BLACK

FRAME SIZE
H - 52cm W - 16cm
P - 26cm

FLINDERS LRG EXT PILLAR MOUNT ANT BLACK

FRAME SIZE
H - 79cm W - 30cm

FLINDERS MEDIUM 1/LT ON STANDARD 3 PIECE POST ANT BLACK

FRAME SIZE
H - 227cm
W - 40cm

FLINDERS LARGE POST TOP ON STANDARD 3 PIECE POST ANT BLACK

FRAME SIZE
H - 242cm
W - 30cm

FLINDERS LRG CHAIN PND ANT BLACK

FRAME SIZE -
H - 68cm W - 30cm

FLINDERS MEDIUM 2/LT ON STANDARD 3 PIECE POST ANT BLACK

FRAME SIZE
H - 227cm
W - 80cm

FLINDERS MEDIUM 3/LT ON STANDARD 3 PIECE POST ANT BLACK

FRAME SIZE
H - 227cm
W - 80cm

- NOTE - INTERIOR USE ONLY

FOR EXTERIOR USE GO TO ROD PENDANT PAGE

*** SUPPLIED * WITH 1/2 METER CHAIN**

*** NOTE *** SINGLE POSTS ARE SUPPLIED WITH A TOTAL 3 PIECE POST - OPTIONAL POST EXTENSION 4

*** NOTE *** LARGE PILLAR MOUNT CAP OPTION

*** NOTE *** MULTI ARM POSTS ARE SUPPLIED WITH A TOTAL 3 PIECE POST - OPTIONAL POST EXTENSION 4

*** NOTE *** MULTI ARM POSTS ARE SUPPLIED WITH A TOTAL 3 PIECE POST - OPTIONAL POST EXTENSION 4

NEW PRODUCT

*** NOTE *** MULTI ARM POSTS ARE SUPPLIED WITH A TOTAL 3 PIECE POST - OPTIONAL POST EXTENSION 4

I.P RATED 23 & 24

Lighting Inspirations

By - *Lode International* - Circa 1965 -



Globe Required

B-15 B-22 E-14 E-27

Flinders Antique Bronze Exterior Range

ANTIQUE BRONZE

FLINDERS LRG EXT W/B BRONZE

FRAME SIZE
H - 78cm
W - 30cm
P - 41cm

FLINDERS MED EXT W/B BRONZE

FRAME SIZE
H - 58cm
W - 20cm
P - 30cm

FLINDERS SML EXT W/B BRONZE

FRAME SIZE
H - 52cm W - 16cm
P - 26cm

FLINDERS LRG EXT PILLAR MOUNT BRONZE

FRAME SIZE
H - 79cm W - 30cm

FLINDERS MEDIUM 1/LT ON STANDARD 3 PIECE POST BRONZE

FRAME SIZE
H - 227cm
W - 40cm

FLINDERS MEDIUM 2/LT ON STANDARD 3 PIECE POST BRONZE

FRAME SIZE
H - 227cm
W - 80cm

FLINDERS MEDIUM 3/LT ON STANDARD 3 PIECE POST BRONZE

FRAME SIZE
H - 227cm
W - 80cm

FOR EXTERIOR USE GO TO ROD PENDANT PAGE

- NOTE - INTERIOR USE ONLY

* SUPPLIED WITH 1/2 METER CHAIN

FLINDERS LRG CHAIN PND BRONZE

FRAME SIZE -
H - 68cm W - 30cm

POST

FRAME SIZE
H - 41cm

FLINDERS LARGE POST TOP ON STANDARD 3 PIECE POST BRONZE

FRAME SIZE
H - 242cm
W - 30cm

NEW PRODUCT

MULTI ARM POSTS ARE SUPPLIED WITH A TOTAL 3 PIECE POST - OPTIONAL POST EXTENSION 4

FLINDERS MEDIUM 1/LT ON STANDARD 3 PIECE POST BRONZE

MULTI ARM POSTS ARE SUPPLIED WITH A TOTAL 3 PIECE POST - OPTIONAL POST EXTENSION 4

FLINDERS MEDIUM 2/LT ON STANDARD 3 PIECE POST BRONZE

MULTI ARM POSTS ARE SUPPLIED WITH A TOTAL 3 PIECE POST - OPTIONAL POST EXTENSION 4

FLINDERS MEDIUM 3/LT ON STANDARD 3 PIECE POST BRONZE

MULTI ARM POSTS ARE SUPPLIED WITH A TOTAL 3 PIECE POST - OPTIONAL POST EXTENSION 4

*** NOTE ***

SINGLE POSTS ARE SUPPLIED WITH A TOTAL 3 PIECE POST - OPTIONAL POST EXTENSION 4

*** NOTE ***

LARGE PILLAR MOUNT CAP OPTION

*** NOTE ***

MULTI ARM POSTS ARE SUPPLIED WITH A TOTAL 3 PIECE POST - OPTIONAL POST EXTENSION 4

*** NOTE ***

MULTI ARM POSTS ARE SUPPLIED WITH A TOTAL 3 PIECE POST - OPTIONAL POST EXTENSION 4

*** NOTE ***

MULTI ARM POSTS ARE SUPPLIED WITH A TOTAL 3 PIECE POST - OPTIONAL POST EXTENSION 4

I.P RATED 23 & 24

ANTIQUE BRONZE

Lighting Inspirations

By - Lode International - Circa 1965 -



Globe Required

Strand Exterior Range

(B-15) (B-22) (E-14) (E-27)

ANTIQUE BRONZE

(E-27)

STRAND MEDIUM POST TOP ON STANDARD 3 PIECE POST BRONZE

FRAME SIZE
H - 223cm
W - 24cm

POST EXTENSION
FRAME SIZE
H - 41cm

*** NOTE ***
SINGLE POSTS ARE SUPPLIED WITH A TOTAL 3 PIECE POST - OPTIONAL POST EXTENSION 4

NEW PRODUCT

STRAND MED EXT W/B BRONZE

FRAME SIZE
H - 50cm W - 24cm P - 30cm

STRAND MED UNDER EAVES BRONZE

FRAME SIZE -
H - 42cm W - 24cm

NEW PRODUCT

LARGE PILLAR MOUNT CAP OPTION

*** NOTE ***
MULTI ARM POSTS ARE SUPPLIED WITH A TOTAL 3 PIECE POST - OPTIONAL POST EXTENSION 4

I.P RATED 23 & 24

STRAND SML EXT W/B BRONZE

FRAME SIZE
H - 41cm W - 21cm P - 23cm

STRAND MED PILLAR MOUNT BRONZE

FRAME SIZE -
H - 53cm W - 24cm

STRAND SMALL 1/LT ON STANDARD 3 PIECE POST BRONZE

FRAME SIZE
H - 230cm W - 42cm

STRAND MEDIUM ROD PND BRONZE

FRAME SIZE
H - 39cm W - 24cm

NOTE -
ROD PENDANTS SUPPLIED WITH 1 METER ROD IN 3 PIECES 50cm+30cm+20cm

STRAND SML UNDER EAVES BRONZE

FRAME SIZE -
H - 35cm W - 21cm

*** NOTE ***
MULTI ARM POSTS ARE SUPPLIED WITH A TOTAL 3 PIECE POST - OPTIONAL POST EXTENSION 4

STRAND SMALL 2/LT ON STANDARD 3 PIECE POST BRONZE

FRAME SIZE
H - 230cm W - 84cm

STRAND MEDIUM ROD PND BRONZE

FRAME SIZE
H - 39cm W - 24cm

STRAND MED PILLAR MOUNT BRONZE

FRAME SIZE -
H - 53cm W - 24cm

STRAND SMALL 3/LT ON STANDARD 3 PIECE POST BRONZE

FRAME SIZE
H - 230cm W - 84cm

NEW PRODUCT

Lighting Inspirations

By - *Lode International* - Circa 1965 -



Globe Required

Toorak Exterior Range

(B-15) (B-22) (E-14) (E-27)

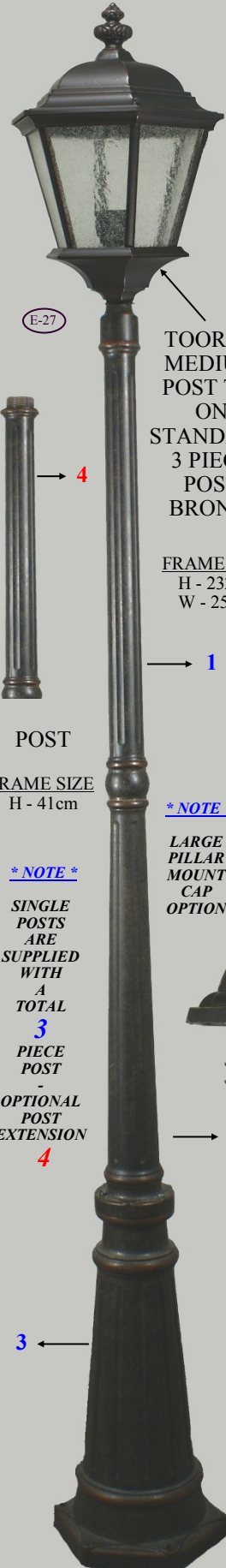

TOORAK MEDIUM POST TOP ON STANDARD 3 PIECE POST BRONZE

FRAME SIZE
H - 232cm W - 25cm

POST
FRAME SIZE
H - 41cm

*** NOTE ***
SINGLE POSTS ARE SUPPLIED WITH A TOTAL 3 PIECE POST - OPTIONAL POST EXTENSION 4



TOORAK MED EXT W/B BRONZE

FRAME SIZE
H - 62cm W - 25cm P - 31m



TOORAK SML EXT W/B BRONZE

FRAME SIZE
H - 52cm W - 20cm P - 27cm

**- NOTE -
INTERIOR USE ONLY**

FOR EXTERIOR USE GO TO ROD PENDANT PAGE



TOORAK MEDIUM CHAIN PND BRONZE

FRAME SIZE -
H - 60cm W - 25cm

*** SUPPLIED *
WITH 1/2 METER CHAIN**



TOORAK MED EXT PILLAR MOUNT BRONZE

FRAME SIZE
H - 66cm W - 25cm



WICKHAM UNDER EAVES BRONZE 2/LT

FRAME SIZE - H - 21cm W - 35cm

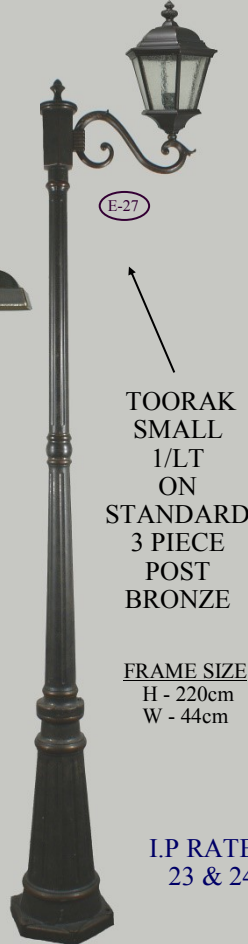

TOORAK SMALL 1/LT ON STANDARD 3 PIECE POST BRONZE

FRAME SIZE
H - 220cm W - 44cm

*** NOTE ***
LARGE PILLAR MOUNT CAP OPTION

NEW PRODUCT

*** NOTE ***
MULTI ARM POSTS ARE SUPPLIED WITH A TOTAL 3 PIECE POST - OPTIONAL POST EXTENSION 4

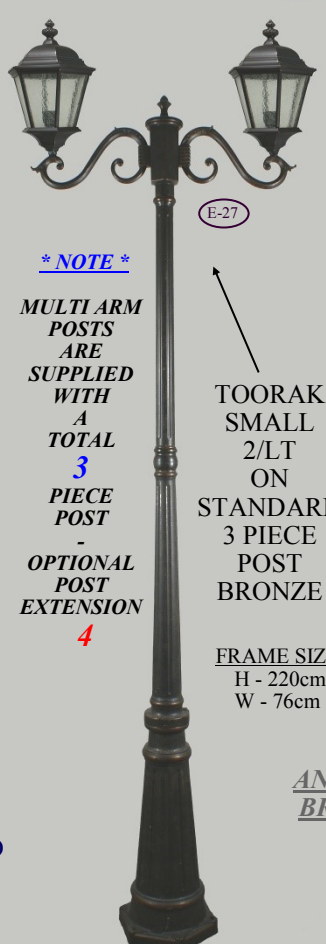

TOORAK SMALL 2/LT ON STANDARD 3 PIECE POST BRONZE

FRAME SIZE
H - 220cm W - 76cm

*** NOTE ***
MULTI ARM POSTS ARE SUPPLIED WITH A TOTAL 3 PIECE POST - OPTIONAL POST EXTENSION 4

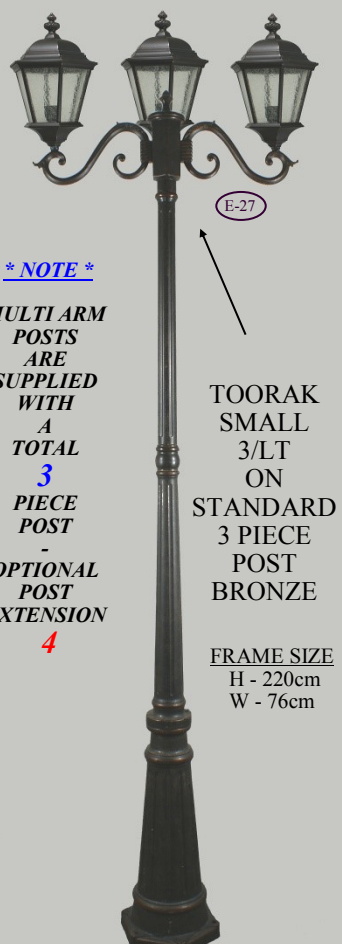

TOORAK SMALL 3/LT ON STANDARD 3 PIECE POST BRONZE

FRAME SIZE
H - 220cm W - 76cm

*** NOTE ***
MULTI ARM POSTS ARE SUPPLIED WITH A TOTAL 3 PIECE POST - OPTIONAL POST EXTENSION 4

ANTIQUE BRONZE

I/P RATED 23 & 24

Lighting Inspirations

By - Lode International - Circa 1965 -



Globe Required

Grove Exterior Range

(B-15) (B-22) (E-14) (E-27)

GROVE LRG EXT W/B BRONZE (E-27)

FRAME SIZE
H - 60cm W - 29cm
P - 34cm

GROVE SML EXT W/B BRONZE (E-27)

FRAME SIZE
H - 40cm W - 18cm
P - 23cm

- NOTE -
FOR INTERIOR USE ONLY

FOR EXTERIOR USE GO TO ROD PENDANT PAGE

* SUPPLIED *
WITH
1/2
METER
CHAIN

GROVE LARGE POST TOP ON STANDARD 3 PIECE POST BRONZE

POST → 4

FRAME SIZE
H - 41cm

GROVE EXT WALL SCONCE BRONZE

FRAME SIZE
H - 232cm W - 33cm

GROVE LRG EXT PILLAR MOUNT BRONZE (E-27)

FRAME SIZE
H - 63cm W - 29cm

GROVE LRG CHAIN PND BRONZE (E-27)

FRAME SIZE -H - 50cm W - 29cm

*** NOTE ***
SINGLE POSTS ARE SUPPLIED WITH A TOTAL 3 PIECE POST - OPTIONAL POST EXTENSION 4

*** NOTE ***
LARGE PILLAR MOUNT CAP OPTION

NEW PRODUCT

→ 2

*** NOTE ***
MULTI ARM POSTS ARE SUPPLIED WITH A TOTAL 3 PIECE POST - OPTIONAL POST EXTENSION 4

*** NOTE ***
MULTI ARM POSTS ARE SUPPLIED WITH A TOTAL 3 PIECE POST - OPTIONAL POST EXTENSION 4

GROVE SMALL 1/LT ON STANDARD 3 PIECE POST BRONZE (E-27)

FRAME SIZE
H - 230cm W - 42cm

*** NOTE ***
MULTI ARM POSTS ARE SUPPLIED WITH A TOTAL 3 PIECE POST - OPTIONAL POST EXTENSION 4

GROVE SMALL 2/LT ON STANDARD 3 PIECE POST BRONZE (E-27)

FRAME SIZE
H - 230cm W - 80cm

*** NOTE ***
MULTI ARM POSTS ARE SUPPLIED WITH A TOTAL 3 PIECE POST - OPTIONAL POST EXTENSION 4

GROVE SMALL 2/LT ON STANDARD 3 PIECE POST BRONZE (E-27)

FRAME SIZE
H - 230cm W - 80cm

I.P RATED 23 & 24

ANTIQUE BRONZE

Lighting Inspirations

By - Lode International - Circa 1965 -



Globe Required

Heritage Exterior Range

B-15 B-22 E-14 E-27

ANTIQUE BLACK

HERITAGE LRG EXT W/B

FRAME SIZE
H - 77cm W - 29cm

E-27

HERITAGE SML EXT W/B

FRAME SIZE
H - 52cm W - 19cm
P - 26cm

E-27

HERITAGE LARGE PILLAR MOUNT

FRAME SIZE -
H - 44cm W - 19cm

E-27

HERITAGE SMALL PILLAR MOUNT

FRAME SIZE -
H - 54cm W - 19cm

E-27

HERITAGE LARGE PILLAR MOUNT

FRAME SIZE -
H - 75cm W - 29cm

E-27

HERITAGE LRG CHAIN PND

FRAME SIZE - H - 65cm W - 29cm

E-27

- NOTE - INTERIOR USE ONLY

FOR EXTERIOR USE GO TO ROD PENDANT PAGE

* SUPPLIED * WITH 1/2 METER CHAIN

HERITAGE LARGE POST TOP ON STANDARD 3 PIECE POST

FRAME SIZE
H - 241cm W - 29cm

POST EXTENSION

FRAME SIZE
H - 41cm

*** NOTE ***

SINGLE POSTS ARE SUPPLIED WITH A TOTAL 3 PIECE POST - OPTIONAL POST EXTENSION

NEW PRODUCT

LARGE PILLAR MOUNT CAP OPTION

*** NOTE ***

HERITAGE SMALL 1/LT ON STANDARD 3 PIECE POST ANT BLACK

FRAME SIZE
H - 240cm W - 42cm

*** NOTE ***

MULTI ARM POSTS ARE SUPPLIED WITH A TOTAL 3 PIECE POST - OPTIONAL POST EXTENSION

HERITAGE SMALL 2/LT ON STANDARD 3 PIECE POST ANT BLACK

FRAME SIZE
H - 240cm W - 80cm

*** NOTE ***

MULTI ARM POSTS ARE SUPPLIED WITH A TOTAL 3 PIECE POST - OPTIONAL POST EXTENSION

HERITAGE SMALL 3/LT ON STANDARD 3 PIECE POST ANT BLACK

FRAME SIZE
H - 240cm W - 80cm

ANTIQUE BLACK

I.P RATED 23 & 24

Lighting Inspirations

By - Lode International - Circa 1965 -



Globe Required

B-15 B-22 E-14 E-27

Elsternwick Exterior Range

ANTIQUE BRONZE

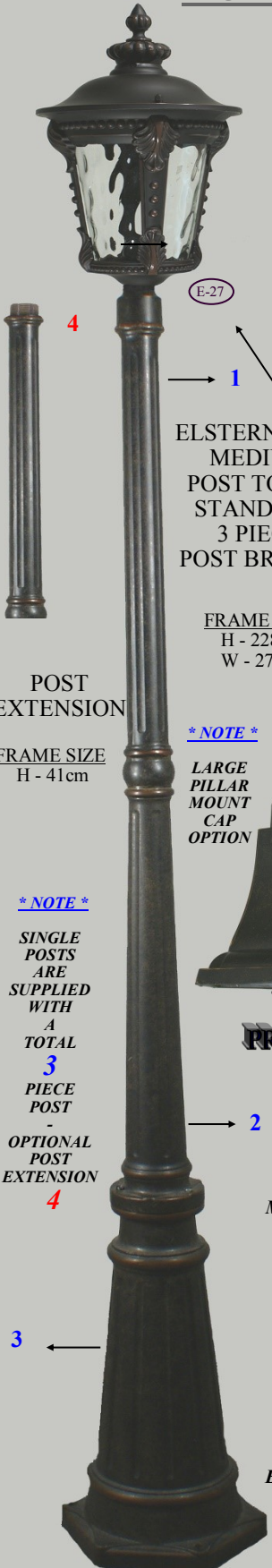

ELSTERNWICK MEDIUM POST TOP ON STANDARD 3 PIECE POST BRONZE

FRAME SIZE
H - 228cm
W - 27cm

*** NOTE ***
LARGE PILLAR MOUNT CAP OPTION

*** NOTE ***
SINGLE POSTS ARE SUPPLIED WITH A TOTAL 3 PIECE POST - OPTIONAL POST EXTENSION

ELSTERNWICK MED EXT PILLAR MOUNT BRONZE

FRAME SIZE
H - 54cm W - 27cm



ELSTERNWICK MEDIUM EXT W/B BRONZE

FRAME SIZE
H - 48cm W - 24cm P - 27cm



ELSTERNWICK SML EXT W/B BRONZE

FRAME SIZE
H - 39cm W - 19cm P - 24cm

- NOTE - INTERIOR USE ONLY

FOR EXTERIOR USE GO TO ROD PENDANT PAGE

* SUPPLIED * WITH 1/2 METER CHAIN



ELSTERNWICK MED CHAIN PND BRONZE

FRAME SIZE -
H - 46cm W - 27cm

POST EXTENSION

FRAME SIZE
H - 41cm



4

NEW PRODUCT



*** NOTE ***
MULTI ARM POSTS ARE SUPPLIED WITH A TOTAL 3 PIECE POST - OPTIONAL POST EXTENSION

*** NOTE ***
MULTI ARM POSTS ARE SUPPLIED WITH A TOTAL 3 PIECE POST - OPTIONAL POST EXTENSION



ELSTERNWICK MEDIUM 1/LT ON STANDARD 3 PIECE POST BRONZE

FRAME SIZE
H - 226cm
W - 44cm

I.P RATED 23 & 24

*** NOTE ***
MULTI ARM POSTS ARE SUPPLIED WITH A TOTAL 3 PIECE POST - OPTIONAL POST EXTENSION

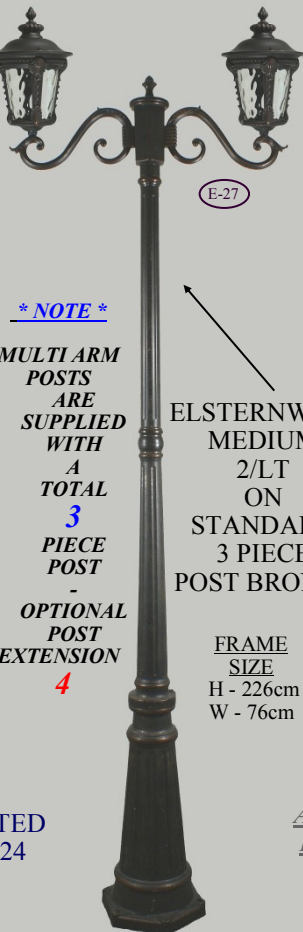

ELSTERNWICK MEDIUM 2/LT ON STANDARD 3 PIECE POST BRONZE

FRAME SIZE
H - 226cm
W - 76cm

ANTIQUE BRONZE

*** NOTE ***
MULTI ARM POSTS ARE SUPPLIED WITH A TOTAL 3 PIECE POST - OPTIONAL POST EXTENSION

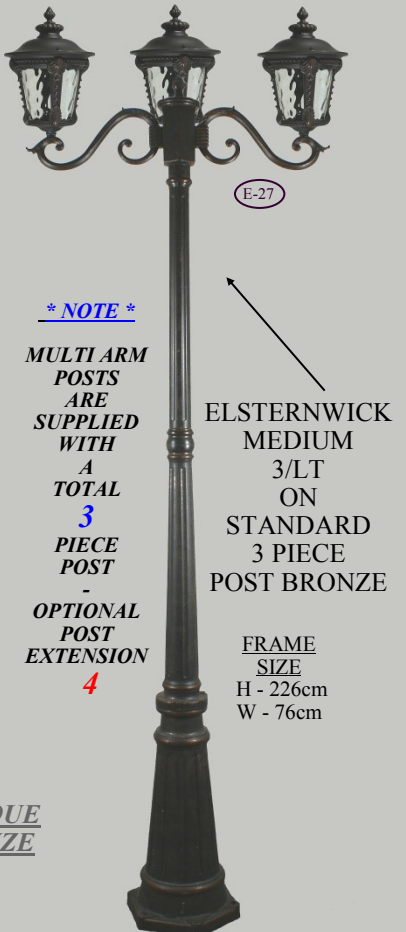

ELSTERNWICK MEDIUM 3/LT ON STANDARD 3 PIECE POST BRONZE

FRAME SIZE
H - 226cm
W - 76cm

Lighting Inspirations



By - *Lode International* - Circa 1965 -

Globe Required

B-15 B-22 E-14 E-27

Exterior Ranges

FOR EXTERIOR USE GO TO ROD PENDANT PAGE

- NOTE - INTERIOR USE ONLY



E-27 CAULFIELD LARGE CHAIN PND BRONZE
FRAME SIZE - H - 42cm W - 26cm



CAULFIELD LARGE EXT W/B BRONZE
FRAME SIZE H - 59cm W - 26cm P - 37cm

ANTIQUE BRONZE



CAULFIELD SMALL EXT W/B BRONZE
FRAME SIZE H - 41cm W - 16cm P - 27cm



CAULFIELD MEDIUM EXT W/B BRONZE
FRAME SIZE H - 48cm W - 21cm P - 35cm

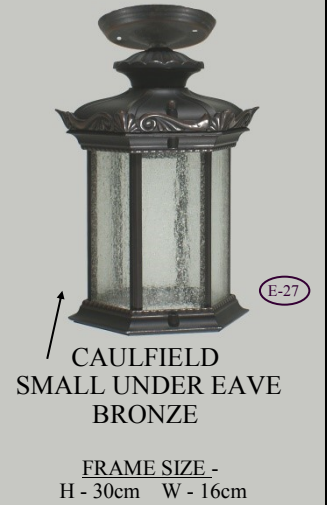

E-27 CAULFIELD SMALL UNDER EAVE BRONZE
FRAME SIZE - H - 30cm W - 16cm



FOR EXTERIOR USE GO TO ROD PENDANT PAGE

- NOTE - INTERIOR USE ONLY

PARADE MEDIUM CHAIN PND BRONZE

FRAME SIZE - H - 27cm W - 22cm

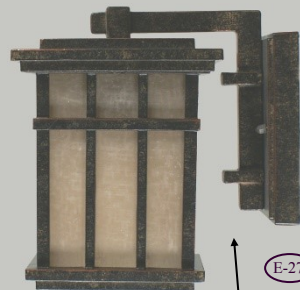

E-27 QUADRANT SMALL EXT W/B BRONZE
FRAME SIZE H - 25cm W - 16cm P - 22cm



E-27 QUADRANT WALL SCONCE EXT BRONZE
FRAME SIZE H - 22cm W - 18cm P - 15cm



E-14 QUADRANT UNDER EAVE EXT [2LT x E14] BRONZE
FRAME SIZE H - 15cm W - 30cm



E-27 PARADE SMALL EXT W/B BRONZE
FRAME SIZE H - 27cm W - 18cm P - 21cm

I.P RATED 23 & 24



E-27 PARADE MEDIUM EXT W/B BRONZE
FRAME SIZE H - 33cm W - 22cm P - 26cm

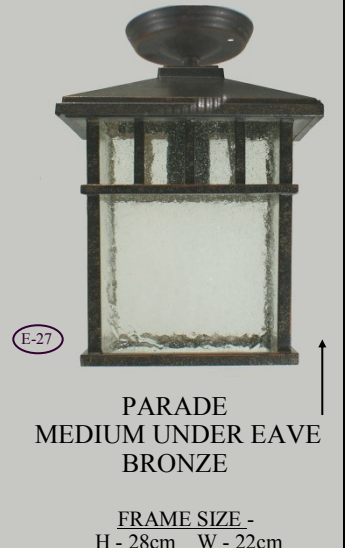

E-27 PARADE MEDIUM UNDER EAVE BRONZE
FRAME SIZE - H - 28cm W - 22cm

Lighting Inspirations

By - Lode International - Circa 1965 -



Globe Required

B-15 B-22 E-14 E-27

Exterior Ranges



HYDE MED ROD PND BRONZE

FRAME SIZE
H - 34cm
W - 22cm

(E-27)



HYDE MEDIUM EXT W/B BRONZE

FRAME SIZE
H - 44cm
W - 22cm
P - 30cm

(E-27)



HYDE MED U/E BRONZE

FRAME SIZE
H - 38cm W - 22cm

(E-27)



HYDE SML U/E BRONZE

FRAME SIZE
H - 27cm W - 17cm

(E-27)



HYDE SMALL EXT W/B BRONZE

FRAME SIZE
H - 33cm
W - 17cm
P - 23cm

(E-27)



ARGYLE W/B ANT/BLACK

FRAME SIZE
H - 31cm
W - 17cm
P - 22cm

(E27)



MANSION MEDIUM EXT W/B BRONZE

FRAME SIZE
H - 38cm W - 23cm
P - 30cm

(E-27)



MANSION SMALL EXT W/B BRONZE

FRAME SIZE
H - 31cm W - 18cm
P - 24cm

(E-27)



STATION EXT W/B ANTIQUE BLACK

FRAME SIZE
H - 41cm
W - 20cm
P - 20cm

(E27)



SOUTHBY EXT W/B ANTIQUE BLACK

FRAME SIZE
H - 29cm
W - 21cm
P - 26cm

(E-27)



SOUTHBY EXT W/B BRONZE

(E-27)



PRAHRAN EXT W/B BRONZE

FRAME SIZE
H - 34cm W - 22cm P - 30cm

(E-27)

NEW PRODUCT

NOTE -
ROD
PENDANTS
SUPPLIED
WITH
1
METER ROD
IN
3 PIECES
50cm+30cm+20cm

NEW PRODUCT

NEW PRODUCT

Lighting Inspirations

By - *Lode International* - Circa 1965 -



Globe Required

(B-15) (B-22) (E-14) (E-27)

Exterior Range



MONTROSE
LARGE WALL SCONCE
BRONZE

FRAME SIZE
H - 45cm W - 28cm P - 14cm



MONTROSE SMALL
WALL SCONCE
BRONZE

FRAME SIZE
H - 35cm W - 22cm
P - 12cm



LOFT
WALL SCONCE
BRONZE

FRAME SIZE
H - 34cm W - 15cm
P - 12cm



DOWNING
WALL SCONCE
BRONZE

FRAME SIZE -
H - 29cm W - 21cm
P - 14cm

DOWNING
SIDE VIEW



PORT EXT W/B
BRONZE

FRAME SIZE
H - 33cm W - 22cm
P - 30cm



WESTALL
EXT W/B BRONZE

FRAME SIZE
H - 31cm W - 30cm P - 34cm



CARDIFF
MEDIUM
EXT W/B
BRONZE

FRAME SIZE
H - 28cm W - 20cm
P - 25cm



PORT EXT U/E
BRONZE

FRAME SIZE
H - 26cm W - 22cm



CARDIFF SMALL
EXT W/B BRONZE

FRAME SIZE
H - 24cm W - 15cm P - 20cm



URBAN
EXT W/B
BRONZE

FRAME SIZE
H - 26cm W - 25cm
P - 43cm



WELSHPOOL
EXT W/B BRONZE

FRAME SIZE
H - 32cm W - 30cm P - 38cm

WESTALL
&
WELSPool
HAVE
A
SCREW IN
CLEAR
GLASS

WESTALL
EXT ROD
PENDANT
BRONZE
FRAME SIZE
H - 23 cm
W - 30cm

I.P RATED
23 & 24

TERMINAL
EXT ROD
PENDANT
ANTIQU
BRONZE
FRAME SIZE
H - 17 cm
W - 21cm

SUPPLIED WITH
104cm ROD
IN 3 x SIZES OF
20cm - 30cm - 50cm

NEW
PRODUCT



TERMINAL/
EXT W/B
BRONZE

FRAME SIZE
H - 26cm W - 21cm
P - 25cm

Lighting Inspirations

By - *Lode International* - Circa 1965 -



Globe Required

B-15 B-22 E-14 E-27

Exterior Range

NEW PRODUCT



E-27

LANE MEDIUM EXT W/B ANTIQUE BLACK

FRAME SIZE
H - cm W - cm P - cm

NEW PRODUCT



E-27

LANE SMALL EXT W/B ANTIQUE BLACK

FRAME SIZE
H - 43cm W - 20cm P - 27cm

AMERICAN HAMPTONS STYLE



E-27

COLLEGE MEDIUM EXT W/B MATT BLACK

FRAME SIZE
H - 40cm W - 18cm P - 22cm

NEW PRODUCT



E-27

COLLEGE SMALL EXT W/B MATT BLACK

FRAME SIZE
H - 30cm W - 13cm P - 15cm



E-27

WICKHAM UNDER EAVES ANTIQUE BLACK 2/LT

FRAME SIZE -
H - 21cm W - 35cm



E-27

WICKHAM UNDER EAVES BRONZE 2/LT

FRAME SIZE -
H - 21cm W - 35cm

NEW PRODUCT



E-27

PARK MEDIUM EXT W/B BRONZE

FRAME SIZE
H - 62cm W - 25cm P - 32cm

NEW PRODUCT



E-27

PARK SMALL EXT W/B BRONZE

FRAME SIZE
H - 49cm W - 20cm P - 28cm

NEW PRODUCT



E-27

STRADA EXT W/B BRONZE

FRAME SIZE
H - 35cm W - 24cm P - 29cm

Lighting Inspirations

By - Lode International - Circa 1965 -

2014 - 2015 Catalogue

" Be Inspired "
And
Discover
The
Difference



- To the retailer -

It is important that you advise your clients of the unique characteristics of our products.

A - Brass hand castings of original antique product in its original state and hand welding.

Resulting in - Cast or welded parts that are not perfect (not straight or surface imperfections) .

Lamp holders may not be perfectly straight.

B - Glassware hand blown to its original look.

Resulting in - Bubbles, slight lines, pin dots, cut edges and slightly off center.

C - Finished surface or painted surface.

Resulting in - Surface imperfections due to chemical plating then hand relieved finish.

Paint color variations from batch to batch.

We will not recognize or accept any unreasonable claim relating to the unique characteristics of our hand made products.

Products can change or vary without notice.

LODE INTERNATIONAL PTY - SHOWROOM- 301-317 RAE STREET NORTH FITZROY VIC AUST
TO ORDER - CALL - 03 - 9486 4115 FAX - 03 - 9486 4246 EMAIL - lodelighting@bigpond.com
WEBSITE - lightinginspirations.com.au