

Havit Platinum





Zack

- **HV8233**
- Satin Nickel
- 3 x max. 20W E27 (no incl.)
- 3 x max. 60W E27 (no incl.)
- Hand made Glass: Variations may occur

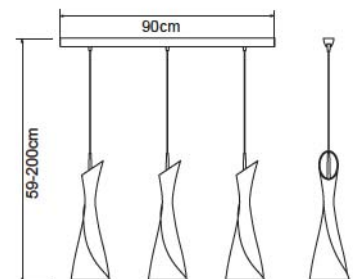



Zack

- **HV8231**
- Satin Nickel
- 3 x max. 20W E27 (no incl.)
- 3 x max. 60W E27 (no incl.)
- Hand made Glass: Variations may occur



Pop

- **HV8246**
- Polished chrome & black
- 1 x 15W E27 (incl.)

- **HV8241**
- Polished chrome & white
- 1 x 15W E27 (incl.)

Exterior

- **HV8203**
- Balle 500mm exterior pendant light
- White epoxy
- Variable height
- E27 240v 13w max
- IP Rating: IP44
- Supplied with a replaceable 3.5w LED globe

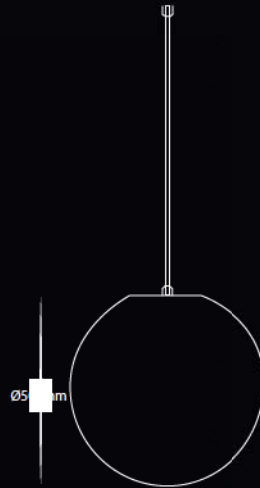

Exterior

- **HV8201**
- Balle 350mm exterior pendant light
- White epoxy
- Variable height
- E27 240v 13w max
- IP Rating: IP44
- Supplied with a replaceable 3.5w LED globe

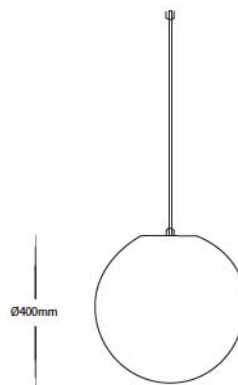

- **HV8202**
- Balle 400mm exterior pendant light
- White epoxy
- Variable height
- E27 240v 13w max
- IP Rating: IP44
- Supplied with a replaceable 3.5w LED globe





Tokio

- **HV8253**
- White + polished chrome
- 5 x max. 40W G9 (incl.)

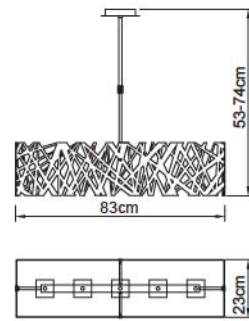

Tokio

- **HV8258**
- White and black (2 layer) + chrome
- 5 x max. 40W G9 (incl.)

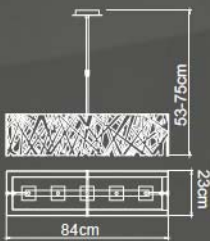



- **HV8253**
- White + polished chrome
- 2 x max. 40W G9 (incl.)

Tokio

- **HV8251**
- White + polished chrome
- 2 x max. 40W G9 (incl.)

Tokio



• HV8252



• HV8250



Tokio

- **HV8257**
- Black + polished chrome
- 2 x max. 40W G9 (incl.)

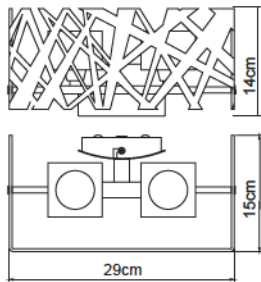

Tokio

- **HV8259**
- White and black (2 layer) + chrome
- 2 x max. 40W G9 (incl.)

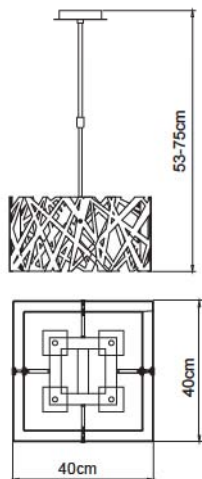

Tokio

- **HV8254**
- Black + polished chrome
- 4 x max. 40W G9 (incl.)
- Semi flush conversion rod included

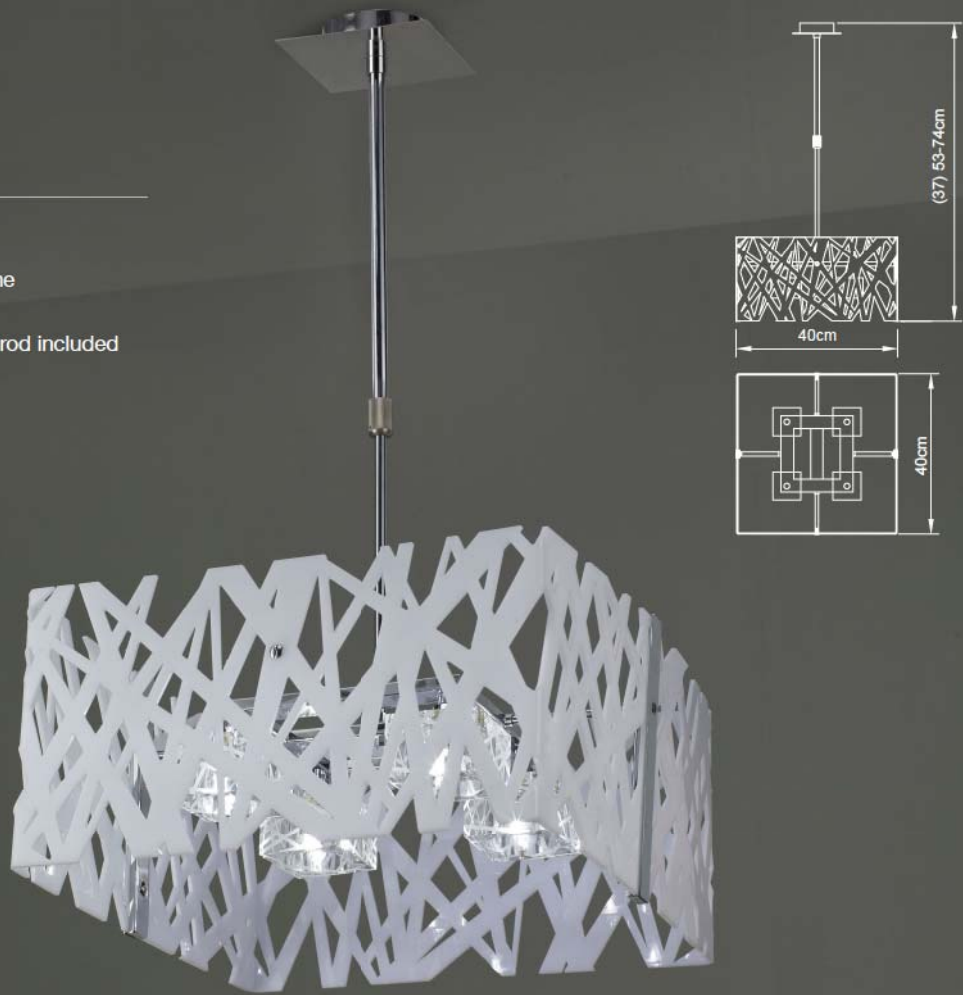

Tokio

- **HV8256**
- Black + polished chrome
- 1 x max. 40W G9 (incl.)

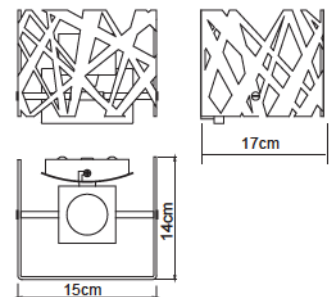



Ora Black

- **HV8227**
- Black lacquer
- 1 x max. 13W E27 (no incl.)

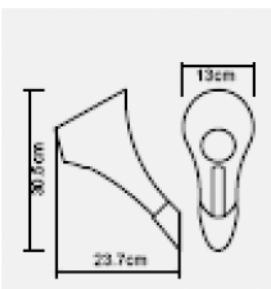

Ora White

- **HV8223**
- White lacquer
- 1 x max. 13W E27 (no incl.)



Cool

- **HV8211**
- White epoxy - IP44
- 2 x max. 23W E27 (no incl.)

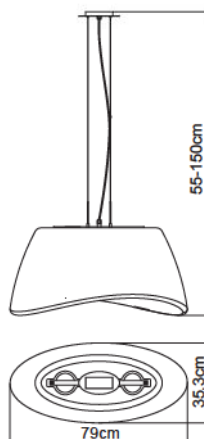



Cool

- **HV8212**
- White epoxy - IP44
- 3 x max. 20W E27 (no incl.)

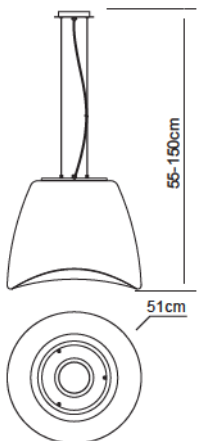

Ora

- **HV8221**
- White lacquer
- 8 x Max. 13W E27 (no incl.)





Ora Black

- **Hv8226**
- Black lacquer
- 8 x Max. 13W E27 (no incl.)

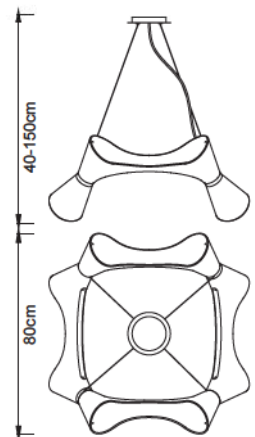



Ora White

- **HV8222**
- White lacquer
- 2 x Max. 13W E27 (no incl.)

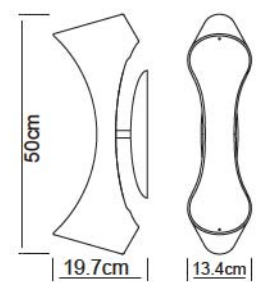

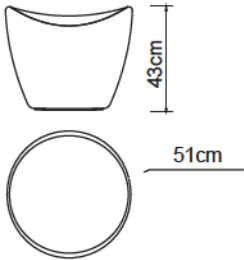

Cool

- **HV8213**
- Outdoor
- RGB IP65
- With remote control





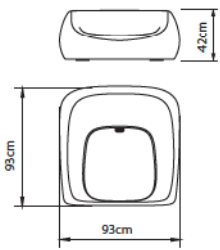

Pao

- **M1523**
- Outdoor
- RGB IP65
- With remote control



Pao

- **M1522**
- Outdoor
- RGB IP65
- With remote control

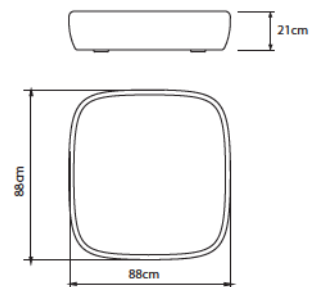



The Sunrise

- **HV8070**
- High density extra strong plaster
- Super bright white
- Easily painted to match decor
- 240v E14 40w Max
- IP rating: IP20
- Can be used with a halogen globe
- Must be used with a suitable LED driver
- Supplied with a replaceable 1.5w LED globe

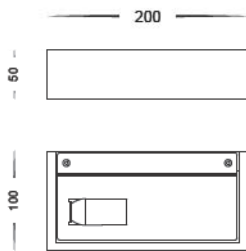

The Gallery Round

- **HV8065**
- High density extra strong plaster
- Super bright white
- Easily painted to match decor
- 240v 3w Built in LED
- IP rating: IP20
- Built-in 3w LED

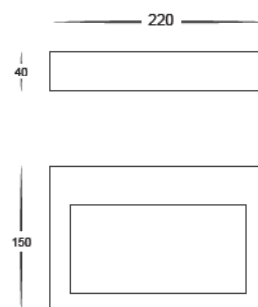



The Aurora

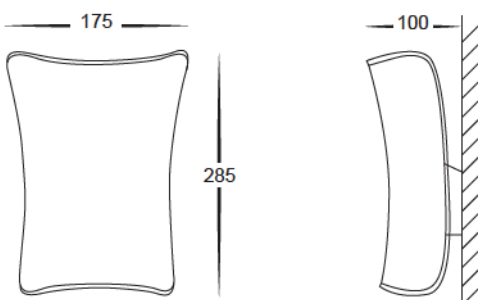

- **HV8030**
- High density extra strong plaster
- Super bright white
- Easily painted to match decor
- 240v E14 40w Max
- Can be used with a halogen globe
- Supplied with a replaceable 1.5w LED globe



The Candy Round

- **HV8060**
- High density extra strong plaster
- Super bright white
- Easily painted to match decor
- 240v 6w Built in LED
- Built-in 2x 3w LED

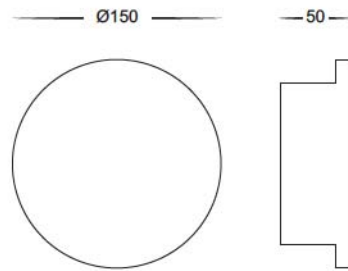

The Candy Square

- **HV8061**
- High density extra strong plaster
- Super bright white
- Easily painted to match decor
- 240v 6w Built in LED
- Built-in 2x 3w LED

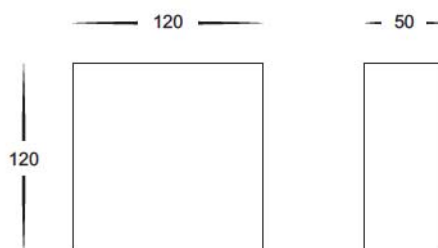



The Gallery Round

- **HV8040**
- High density extra strong plaster
- Super bright white
- Easily painted to match decor
- 240v 6w Built in LED
- Built-in 2x 3w LED

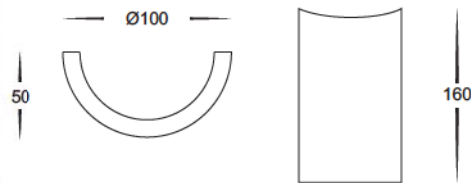

The Gallery Square

- **HV8041**
- High density extra strong plaster
- Super bright white
- Easily painted to match decor
- 240v 6w Built in LED
- Built-in 2x 3w LED

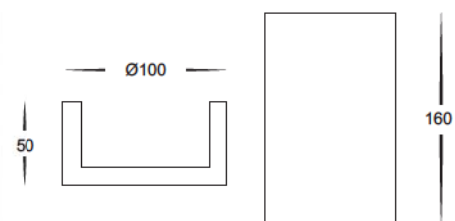

The Pyramid

- **HV8050**
- High density extra strong plaster
- Super bright white
- Easily painted to match decor
- Built-in 1x3w LED



The Arc Large

- **HV8026**
- High density extra strong plaster
- Super bright white
- Easily painted to match decor
- 240v G9 25w Max
- Can be used with a halogen globe
- Supplied with a replaceable 2w LED globe

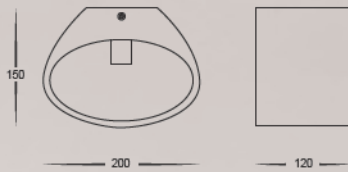

The Arc Small

- **HV8025**
- High density extra strong plaster
- Super bright white
- Easily painted to match decor
- 240v G9 25w Max
- Can be used with a halogen globe
- Supplied with a replaceable 1.4w LED globe

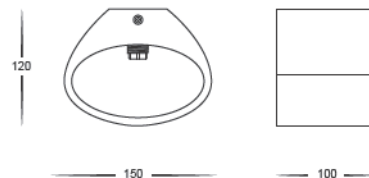



The Concept

- **HV8027**
- High density extra strong plaster
- Super bright white
- Easily painted to match decor
- G9
- Can be used with a halogen globe
- Supplied with a replaceable G9 LED globe

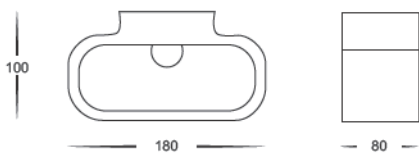

The Golf

- **HV8020**
- High density extra strong plaster
- Super bright white
- Easily painted to match decor
- 240v G9 25w Max
- Can be used with a halogen globe
- Supplied with a replaceable 2w LED globe

