

BOLUCE[®]
ILLUMINAZIONE

CATALOGO GENERALE - GENERAL CATALOGUE 2012/2013

BOLUCE[®]
ILLUMINAZIONE



MADE IN ITALY



BOLUCE[®]
ILLUMINAZIONE

Boluce illuminazione® è una azienda storica italiana con sede in Bergamo.

Da 40 anni si occupa della produzione di articoli di illuminazione per esterni ed interni.

I suoi prodotti sono destinati a tutti i mercati mondiali.

Il design delle sue lampade, moderno ed essenziale, si adatta perfettamente ad architetture sia classiche sia contemporanee fornendo ad arredatori ed architetti valide alternative di arredo.

Forte della sua esperienza, ma attenta all'evolversi delle nuove tecnologie, Boluce produce da anni prodotti a LED, oggi anche a tensione di rete, che rendono non necessario l'uso di costosi e spesso delicati alimentatori o trasformatori, pur garantendo lunga durata, elevato flusso luminoso e bassissimi consumi.

La produzione è rigorosamente **MADE IN ITALY** e viene realizzata con materie prime e componenti esclusivamente italiani.

La verniciatura in polvere poliestere viene effettuata tramite un processo altamente moderno che garantisce la massima resistenza agli agenti atmosferici e all'invecchiamento.

Gli apparecchi sono verificati secondo le norme applicabili prima della loro immissione sul mercato.

Tutti gli apparecchi sono conformi alle direttive Europee in tema di sicurezza e prestazione.

Boluce illuminazione® is an Italian historical company located in Bergamo.

It is since 40 years in the production of luminaires for exterior and interior lighting.

Its products are designed for all the world's market.

The luminaires design, modern and essential, suits perfectly to classic and contemporary architecture giving decorators and architects effective alternatives of furnishing .

Thanks to Its experience, and very careful to the development of new technologies, Boluce produces LED products for years, today also at mains voltage, which make it un-necessary the use of expensive and often delicate feeders or transformers, meanwhile ensuring long-life, high luminous flux and low consumption.

*The production is strictly **MADE IN ITALY** and is made with italian raw materials and components.*

The polyester powder coating is carried out through a highly modern process that guarantees the strongest resistance to atmospheric agents and to ageing.

The appliances are verified according to the applicable standards before placing them on the market.

All the appliances are designed and built according to Safety and Performance European Directives.



Made in Italy

Sicurezza

Internationalization

Affidabilità

Assistenza

Garanzia

Innovation

Quality

Flexibility

Sviluppo

Controllo

Ricerca

Design

Progettazione

Technology

Competitività

Armony

Collection



INDICE

INDEX



Dixie Stelo - 53

Belt - 15

Slash Stelo - 11

Slash - 11

DM 4 - 27

Line - 21

DM 3 - 27

Amos - 47

Sharp-35

Dixie - 53

Blues - 39



Box - 53

DM 4 stelo - 27



N 07 - 63

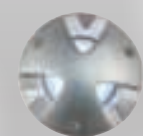

Six - 79



Blitz - 63

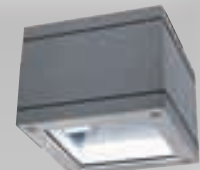

Half - 75

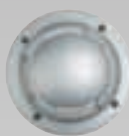

Zed - 91



Trek - 83



Blitz Quad - 63



Lid - 95



Lid stelo - 95



Diana - 101



Style - 109



Ipse - 113



Gamma - 119



Adas - 171



Flash - 119



Enco - 225



Ritz - 105



Quad - 175



Helios - 161



Geo - 137



Spotty - 191



Greta - 217



Clic - 127



Dig - 187



Show - 213



Selecta Stelo - 229



Sprint - 195



Spark - 203



Selecta - 229



Enco Stelo - 225



INDICE

INDEX



Dune - 237



Dune Stelo - 237



Intro - 243



Intro Stelo - 243



Twist - 253



Luna - 259



Ska - 249



Stick - 269



Argo - 281



Blob - 275



Ares inox - 265



Airone - 297



Lexus - 285



Zeus - 289



Ares 2 - 289



Ray - 269



Airone Stelo - 297



Ares - 289





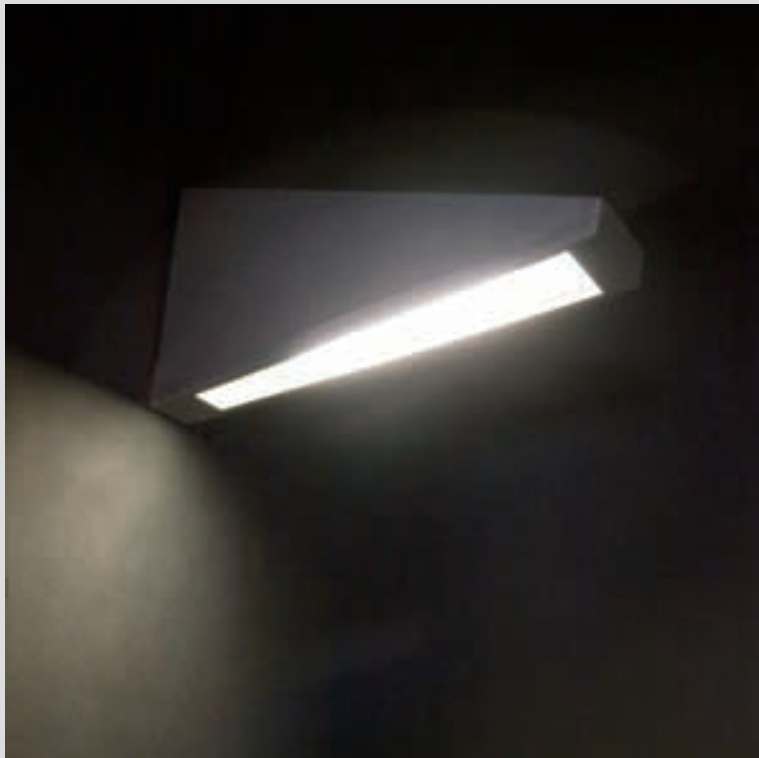



SLASH

SLASH STELO



SLASH

Apparecchio per illuminazione di esterni applicabile a parete disponibile in due dimensioni BIG e MINI costituito da:

- Corpo in alluminio pressofuso verniciato
- Diffusore in vetro temperato satinato
- Parabola riflettente in alluminio
- Guarnizioni in silicone
- Viti di chiusura in acciaio inox
- Verniciatura in polveri poliestere ad elevata resistenza ai raggi ultravioletti e alla corrosione

Outdoor wall luminaire available in two sizes BIG and MINI constructed of:

- Painted die-cast aluminium body
- Tempered satin glass diffuser
- Aluminium reflector
- Silicon gaskets
- Stainless steel screws
- Painting using high resistance to UV and corrosion polyester powders



SLASH STELO

Piantana per esterni a una o a due luci composta da:

- Palo in alluminio estruso verniciato
- Corpo superiore in alluminio pressofuso verniciato

One or two lights outdoor post luminaire constructed of:

- Painted extruded aluminium post
- Painted die-cast aluminium head



Colori - Colours

X=2 Bianco
White

X=3 Nero
Black

X=9 Antracite
Anthracite

X=4 Silver

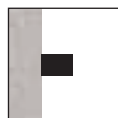

SLASH
Installazione
a parete
Wall mounting



SLASH STELO
Installazione
a terra
Floor mounting

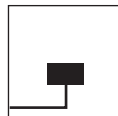

Entrata singola
cavi di alimentazione
Single power supply
cables input

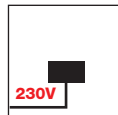

LED - art. 6020.88X - 6021.88X - 6024.88X
Led a tensione di rete 220/240V 50Hz.
Connessione diretta alla rete di alimentazione
senza necessità di trasformatore.
LED's direct operation at 220/240V 50Hz.
No transformer is required.



IK 05

Direttiva/Directive
EuP/ErP (2005/52/CE-2009/125/CE)
Gli apparecchi per lampade a scarica ad alta intensità sono progettati per lampade chiare e opali.
Luminaires for high intensity discharge lamps are designed for either clear and coated lamps.

Diffusore - Diffuser

Codice-Code 00 6020
per/for **SLASH BIG**

Codice-Code 00 6024
per/for **SLASH MINI**

Le lampadine vengono fornite solo su richiesta

Bulbs supplied only on request



6024 MINI

6024.14X QT14 25W G9
6024.88X 1LED bianco/white 4,1W 230 lm 6300 K

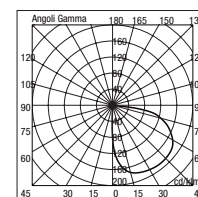
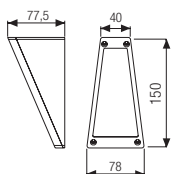

6024 14



6020 BIG

6020.95X TC-DEL 26 W G24 q-3
 Con reattore elettronico / With electronic ballast
6020.85X HIT-TC 20 W G8,5
 Con reattore elettronico / With electronic ballast
6020.88X 3LED bianco/white 12,3W 690 lm 6300 K

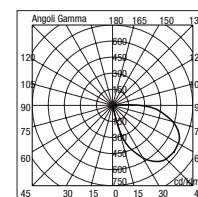
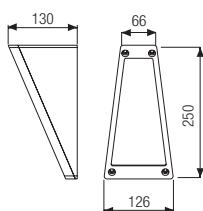

6020 85

SLASH STELO



6021 BIG

6021.95X TC-DEL 26 W G24 q-3
 Con reattore elettronico / With electronic ballast
6021.85X HIT-TC 20 W G8,5
 Con reattore elettronico / With electronic ballast
6021.88X 3LED bianco/white 12,3W 690 lm 6300 K

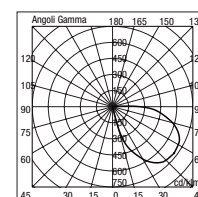
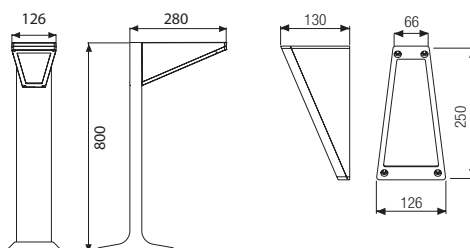

6021 85



6022 BIG

6022.95X TC-DEL 2x26W G24 q-3
 Con reattore elettronico / With electronic ballast
6022.85X HIT-TC 2x20W G8,5
 Con reattore elettronico / With electronic ballast

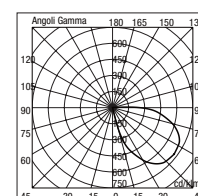
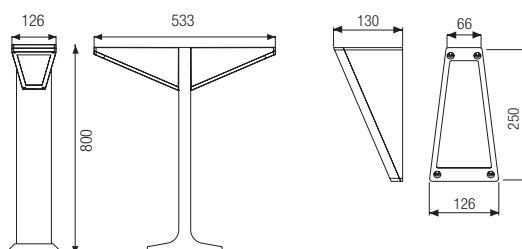

6022 85





BELT BIG

BELT MINI



BELT BIG

Apparecchio da esterni per installazione a parete o a terra costituito da:

- Corpo in alluminio pressofuso verniciato
- Diffusore in policarbonato
- Parabola riflettente in alluminio
- Guarnizioni in silicone
- Viti di chiusura in acciaio inox
- Verniciatura in polveri poliestere ad elevata resistenza ai raggi ultravioletti e alla corrosione

Wall or ground outdoor luminaire constructed of:

- Painted die-cast aluminium body
- Polycarbonate diffuser
- Aluminium reflector
- Silicon gaskets
- Stainless steel screws
- Painting using high resistance to UV and corrosion polyester powders



Colori - Colours

X=2  Bianco
White

X=3  Nero
Black

X=9  Antracite
Anthracite

X=4  Silver

Diffusore - Diffuser

Codice-Code 08 4040

Le lampadine vengono fornite solo su richiesta

Bulbs supplied only on request

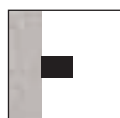

4040
Installazione a parete
Wall mounting



4046
Installazione a terra
Floor mounting

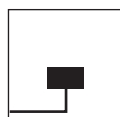

Entrata singola cavi di alimentazione
Single power supply cables input

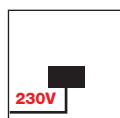

10 LED
L'apparecchio è fornito completo di alimentatore elettronico Full Range 100/240V 50/60Hz posizionato all'interno dell'apparecchio.
The luminaire is supplied with a Full Range 100/240V 50/60Hz built-in transformer



IK 09



L'apparecchio BELT a parete può essere installato sia orizzontale sia verticale

BELT wall luminaire can be installed both horizontal and vertical

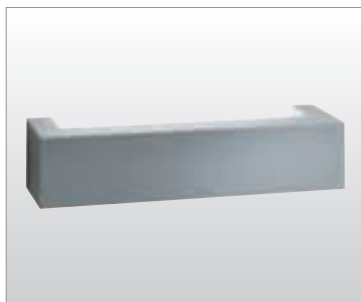

4040



Installazione a parete

Wall mounting

4040.99X  TC-L 24W 2G11

Con reattore elettronico / With electronic ballast

4040.66X 10 LED bianco/white 12W 1350 lm 6000 K

Con alimentatore elettronico incorporato / Built-in electronic power supplier

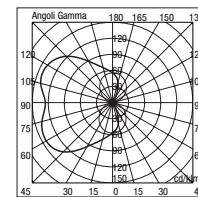
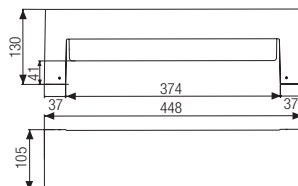

4040 99

Installazione a terra

Floor mounting

4046.99X  TC-L 24W 2G11

Con reattore elettronico / With electronic ballast

4046.66X 10 LED bianco/white 12W 1350 lm 6000 K

Con alimentatore elettronico incorporato / Built-in electronic power supplier

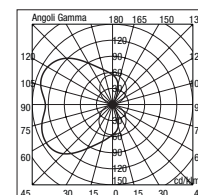
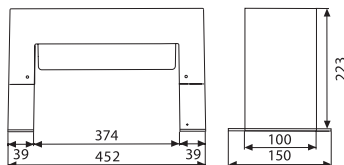

4046 99



4046



BELT MINI

Apparecchio da esterni per installazione a parete costituito da:

- Corpo in alluminio pressofuso verniciato
- Diffusore in policarbonato
- Parabola riflettente in alluminio
- Guarnizioni in silicone
- Viti di chiusura in acciaio inox
- Verniciatura in polveri poliestere ad elevata resistenza ai raggi ultravioletti e alla corrosione

Wall outdoor luminaire constructed of:

- Painted die-cast aluminium body
- Polycarbonate diffuser
- Aluminium reflector
- Silicon gaskets
- Stainless steel screws
- Painting using high resistance to UV and corrosion polyester powders



Colori - Colours

X=2  Bianco
White

X=3  Nero
Black

X=9  Antracite
Anthracite

X=4  Silver

Diffusore - Diffuser

Codice-Code 08 6060

Le lampadine vengono fornite solo su richiesta

Bulbs supplied only on request

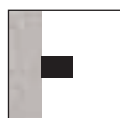

Installazione a parete
Wall mounting

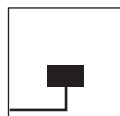

Entrata singola cavi di alimentazione
Single power supply cables input

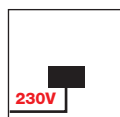

LED - art. 6060.88X
Led a tensione di rete 220/240V 50Hz.
Connessione diretta alla rete di alimentazione senza necessità di trasformatore.
LED's direct operation at 220/240V 50Hz.
No transformer is required.

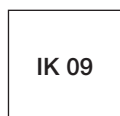

L'apparecchio BELT MINI può essere installato sia orizzontale sia verticale

BELT MINI luminaire can be installed both horizontal and vertical

BELT MINI



6060

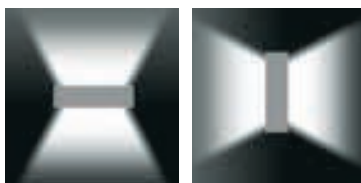

6060.92X  TC-DE 10W G24 q-1
 Con reattore elettronico / With electronic ballast

6060.88X 2LED bianco/white 8,2W 460 lm 6300 K

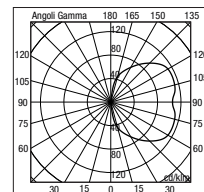
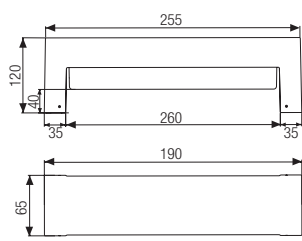

6060.92

BELT MINI

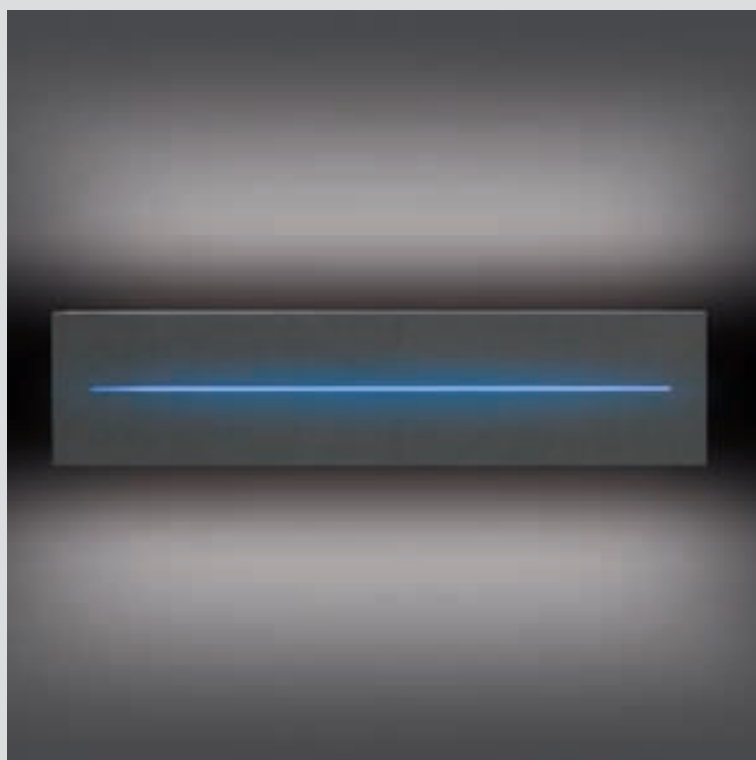



LINE

BLUE LINE



LINE

Apparecchio per esterni a parete.

Disponibile in tre dimensioni:

LINE 510

LINE 320

LINE 210

È costituito da:

- Corpo in alluminio pressofuso verniciato
- Diffusore in vetro satinato
- Parabola riflettente in alluminio
- Guarnizioni in silicone
- Viti di chiusura in acciaio inox
- Verniciatura in polveri poliestere ad elevata resistenza ai raggi ultravioletti e alla corrosione

PER BLUE LINE

- Linea luminosa in policarbonato blu

Outdoor wall luminaire available in 3 different sizes:

LINE 510

LINE 320

LINE 210

It is constructed of:

- Painted die-cast aluminium body
- Satin glass diffuser
- Aluminium reflector
- Silicon gaskets
- Stainless steel screws
- Painting using high resistance to UV and corrosion polyester powders

FOR BLUE LINE

- Blue lighted polycarbonate stripe



Line Colori - Line Colours

X=2 Bianco
White

X=3 Nero
Black

X=9 Antracite
Anthracite

X=4 Silver

Blue Line Colori - Blue Line Colours

X=4 Silver

X=9 Antracite
Anthracite

Diffusore - Diffuser

Codice-Code 00 6061

00 6063

00 6065

Le lampadine vengono fornite solo su richiesta

Bulbs supplied only on request

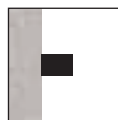

Installazione a parete
Wall mounting

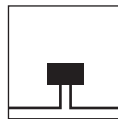

Doppia entrata cavi di alimentazione
Double power supply cables input

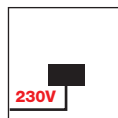

6 LED

L'apparecchio è fornito completo di alimentatore elettronico Full Range 100/240V 50/60Hz posizionato all'interno dell'apparecchio.
The luminaire is supplied with a Full Range 100/240V 50/60Hz built-in transformer



IK 07



L'apparecchio LINE 510 può essere installato sia orizzontale sia verticale

LINE 510 luminaire can be installed both horizontal and vertical

Direttiva/Directive

EuP/ErP (2005/52/CE-2009/125/CE)

Gli apparecchi per lampade a scarica ad alta intensità sono progettati per lampade chiare e opali.

Luminaires for high intensity discharge lamps are designed for either clear and coated lamps.







6061 - 6062 LINE 510



Monodirezionale
Mono direction light

6061.94X  TC-L 1x36W 2G11
Con reattore elettronico / With electronic ballast

Bidirezionale
Double direction light

6062.94X  TC-L 2x36W 2G11
Con reattore elettronico / With electronic ballast

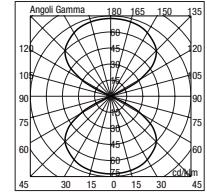

6062 94

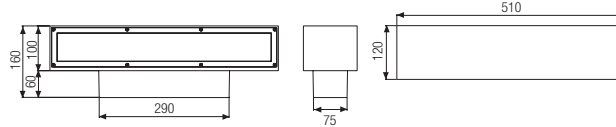

6063 - 6064 LINE 320



Monodirezionale
Mono direction light

6063.95X  TC-D 2x26W G24 d-3
6063.78X  HIT-DE 70W Rx7s

Bidirezionale
Double direction light

6064.95X  TC-D 2x26W G24 d-3
6064.78X  HIT-DE 70W Rx7s

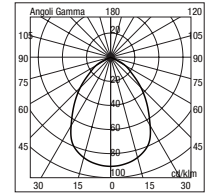

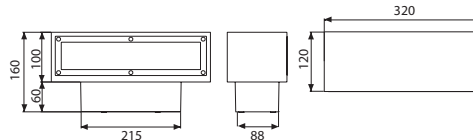

6063 78



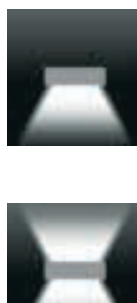

6065 - 6066 LINE 210



Monodirezionale
Mono direction light

6065.95X  TC-D 26W G24 d-3
6065.76X  QT-DE12 80W R7s
6065.66X  6 LED bianco/white 7,5W 810 lm 6000 K
Con alimentatore elettronico incorporato / Built-in electronic power supplier

Bidirezionale
Double direction light

6066.95X  TC-D 26W G24 d-3
6066.76X  QT-DE12 80W R7s
6066.66X  2x6LED bianco/white 2x7,5W 2x810 lm 6000 K
Con alimentatore elettronico incorporato / Built-in electronic power supplier

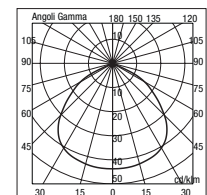

6065 95

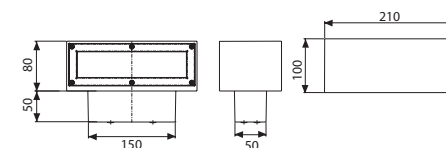



Rica Seiljet Hotel - MOLDE - Norge

TECNICA RAZIONALE E NOTE DI COLORE

Nella Blue Line una linea retta attraversa tutta la lampada con un effetto di luce elegante e raffinato.

RATIONAL TECHNIQUE AND EMOTIONAL NOTES OF COLOR

In the Blue Line a straight line crosses the body of the luminaire giving to it a fine and elegant light effect.

BLUE LINE

BLUE LINE



6071 - 6072 BLUE LINE 510

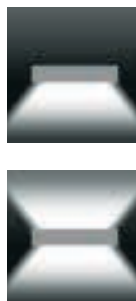

Monodirezionale

Mono direction light

6071.94X  TC-L 1x36W 2G11

Con reattore elettronico / With electronic ballast

Bidirezionale

Double direction light

6072.94X  TC-L 2x36W 2G11

Con reattore elettronico / With electronic ballast

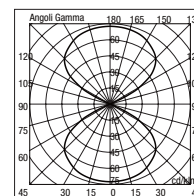
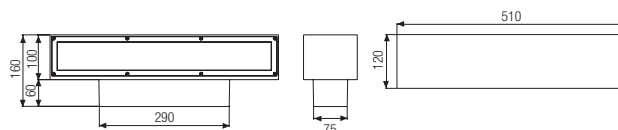

6072 94



6073 - 6074 BLUE LINE 320



Monodirezionale

Mono direction light

6073.95X  TC-D 2x26W G24 d-3

6073.78X  HIT-DE 70W Rx7s

Bidirezionale

Double direction light

6074.95X  TC-D 2x26W G24 d-3

6074.78X  HIT-DE 70W Rx7s

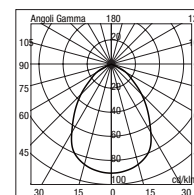
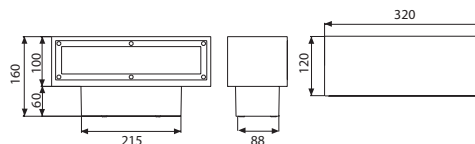

6073 78



6075 - 6076 BLUE LINE 210

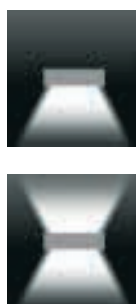

Monodirezionale

Mono direction light

6075.95X  TC-D 26W G24 d-3

6075.76X  QT-DE12 80W R7s

6075.66X 6 LED bianco/white 7,5W 810 lm 6000 K

Con alimentatore elettronico incorporato / Built-in electronic power supplier

Bidirezionale

Double direction light

6076.95X  TC-D 26W G24 d-3

6076.76X  QT-DE12 80W R7s

6076.66X 2x6LED bianco/white 2x7,5W 2x810 lm 6000 K

Con alimentatore elettronico incorporato / Built-in electronic power supplier

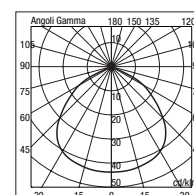
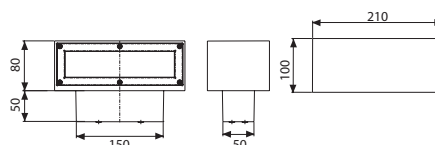

6075 95

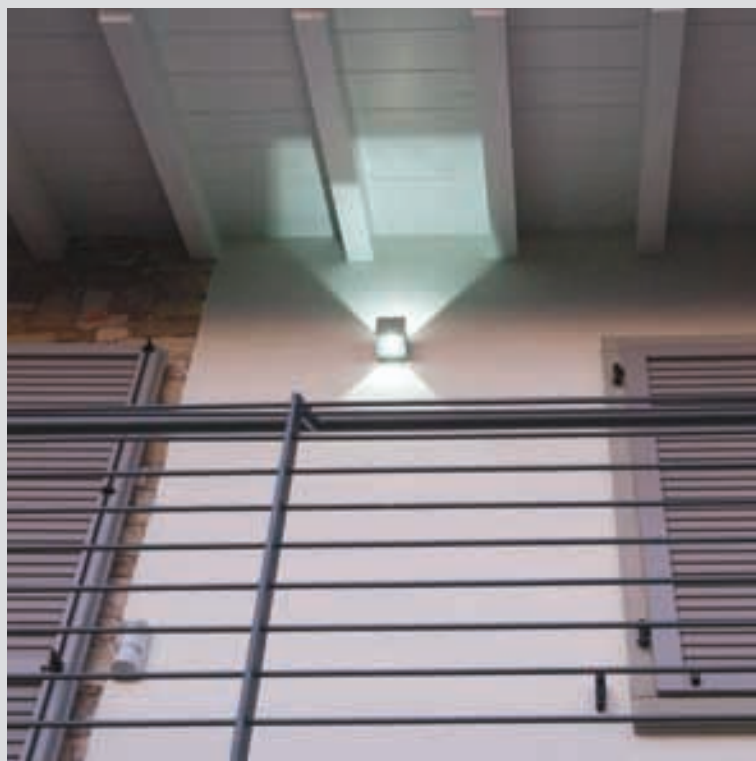



DM 3

DM 4



DM 4 STELO



DM 3

Apparecchio da parete per illuminazione di interni e di esterni ad emissione di luce con varie aperture di fasci luminosi costituito da:

- Struttura in alluminio pressofuso verniciato
- Vetri piani temperati e/o lenti
- Parabola riflettente in alluminio
- Guarnizioni in silicone
- Viti di chiusura in acciaio inox
- Verniciatura in polveri poliestere ad elevata resistenza ai raggi ultravioletti e alla corrosione

Wall outdoor and indoor luminaire with various light beams constructed of:

- Painted die-cast aluminium structure
- Tempered glasses or/and lenses
- Aluminium reflector
- Silicon gasket
- Stainless steel screws
- Painting using high resistance to UV and corrosion polyester powders



Colori - Colours

X=2 Bianco / White

X=3 Nero / Black

X=9 Antracite / Anthracite

X=4 Silver

Diffusore - Diffuser

Codice-Code 00 4031

vetro / glass

Codice-Code 04 4033

lente rettangolare / rectangular lens

Le lampadine vengono fornite solo su richiesta ad eccezione della versione T2 6W e 60 LED

Bulbs supplied only on request except for T2 6W and 60 LED version

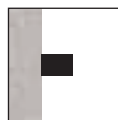

Installazione a parete
Wall mounting

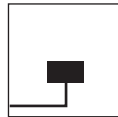

Entrata singola cavi di alimentazione
Single power supply cables input

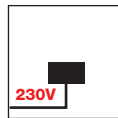

LED - art. 4031.88X - 4032.88X - 4033.88X
Led a tensione di rete 220/240V 50Hz.
Connessione diretta alla rete di alimentazione senza necessità di trasformatore.
LED's direct operation at 220/240V 50Hz.
No transformer is required.

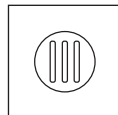

Fluorescente 6W Gx53
Non necessita di alcun alimentatore.
Fluorescent lamp 6W Gx53
Does not need the power supplier

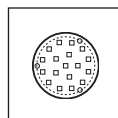

60 LED Gx53
Non necessita di alcun alimentatore.
60 LED Gx53
Does not need the power supplier

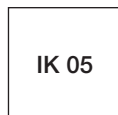

IK 05



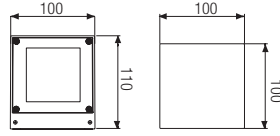

4031

Monodirezionale con un vetro

Mono direction light with one glass

4031.15X		QPAR16	35W	GU10		
• 4031.60X		T2	6W	Gx53		
• 4031.68X		60LED bianco/white	4W	Gx53	260 lm	4000 K
4031.88X		1LED bianco/white	4,1W		230 lm	6300 K

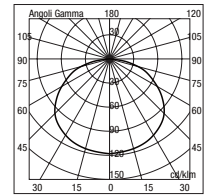

4031 60



4032

Bidirezionale con due vetri

Double direction light with two glasses

4032.14X		QT14	60W	G9		
4032.88X		2LED bianco/white	2x4,1W		2x230 lm	6300 K

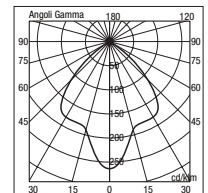

4032 14



4033

Bidirezionale con una lente e un vetro

Double direction light with 1 lens and 1 glass

4033.14X		QT14	60W	G9		
4033.88X		2LED bianco/white	2x4,1W		2x230 lm	6300 K

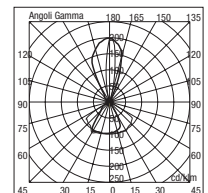

4033 14

- L'apparecchio viene fornito completo di lampadina
Bulb enclosed to the luminaire

DM 4

Apparecchio da parete per illuminazione di interni e di esterni ad emissione di luce con varie aperture di fasci luminosi costituito da:

- Struttura in alluminio pressofuso verniciato
- Vetri piani temperati e/o lenti
- Parabola riflettente in alluminio
- Guarnizioni in silicone
- Viti di chiusura in acciaio inox
- Verniciatura in polveri poliestere ad elevata resistenza ai raggi ultravioletti e alla corrosione

Wall outdoor and indoor luminaire with various light beams constructed of:

- Painted die-cast aluminium structure
- Tempered glasses or/and lenses
- Aluminium reflector
- Silicon gasket
- Stainless steel screws
- Painting using high resistance to UV and corrosion polyester powders



DM 4 STELO

Piantana da giardino per esterni. Costituita da:

- Palo in alluminio estruso verniciato
- Corpo superiore in alluminio pressofuso verniciato

Garden post luminaire constructed of:

- Painted extruded aluminium post
- Painted die-cast aluminium head



Colori - Colours

X=2 Bianco
White

X=3 Nero
Black

X=9 Antracite
Anthracite

X=4 Silver

Diffusore - Diffuser

Codice-Code 00 3031

00 3034

vetro / glass

Codice-Code 04 3033

lente rettangolare / rectangular lens

Le lampadine vengono fornite solo su richiesta

Bulbs supplied only on request

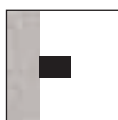

DM 4
Installazione a parete
Wall mounting



DM 4 STELO
Installazione a terra
Floor mounting

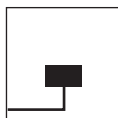

Entrata singola cavi di alimentazione
Single power supply cables input

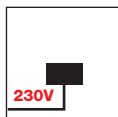

LED - art. 3031.88X - 3032.88X - 3033.88X
Led a tensione di rete 220/240V 50Hz.
Connessione diretta alla rete di alimentazione senza necessità di trasformatore.
LED's direct operation at 220/240V 50Hz.
No transformer is required.

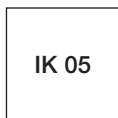

IK 05



ACCESSORIO: art. PT74
Questo accessorio serve per chiudere una o più uscite di luce secondo le esigenze di installazione
This part is used to close one or more light openings as for the installation's necessities

Direttiva/Directive

EuP/ErP (2005/52/CE-2009/125/CE)

Gli apparecchi per lampade a scarica ad alta intensità sono progettati per lampade chiare e opali.

Luminaires for high intensity discharge lamps are designed for either clear and coated lamps.



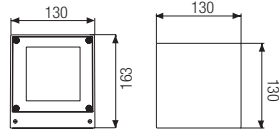

3031

Monodirezionale con un vetro

Mono direction light with one glass

3031.83X  TC-T 26W GX24 d-3**3031.85X**  HIT-TC 20W G8,5

Con reattore elettronico / With electronic ballast

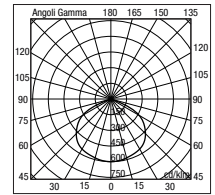
3031.88X 2LED bianco/white 8,2W 460 lm 6300 K

3031 85



3032

Bidirezionale con due vetri

Double direction light with two glasses

3032.83X  TC-T 26W GX24 d-3**3032.85X**  HIT-TC 20W G8,5

Con reattore elettronico / With electronic ballast

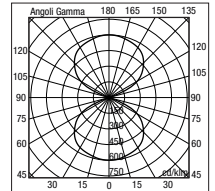
3032.88X 4LED bianco/white 2x8,2W 2x460 lm 6300 K

3032 85



3033

Bidirezionale con una lente e un vetro

Double direction light with 1 lens and 1 glass

3033.85X  HIT-TC 20W G8,5

Con reattore elettronico / With electronic ballast

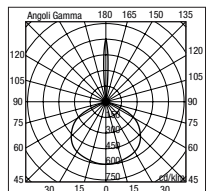
3033.88X 3LED bianco/white 12,3W 690 lm 6300 K



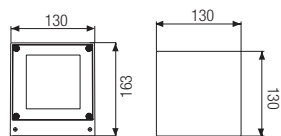

3033 85

DM 4
DM 4



3034

4 fasci luminosi
4 light beams

3034.00X		A60	60W	E27
3034.84X		TC-T	18W	GX24 d-2
3034.83X		TC-T	26W	GX24 d-3
3034.85X		HIT-TC	20 W	G8,5

Con reattore elettronico / With electronic ballast

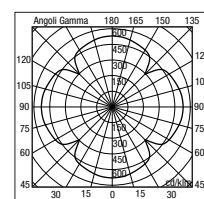

3034 85





3035 H 300

3035.00X		A60	60W	E27
3035.83X		TC-T	26W	GX24 d-3
3035.85X		HIT-TC	20W	G8,5

Con reattore elettronico / With electronic ballast

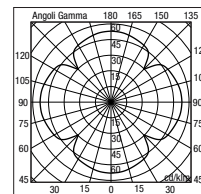
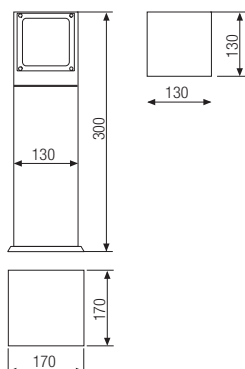

3035 85



3036 H 500

3036.00X		A60	60W	E27
3036.83X		TC-T	26W	GX24 d-3
3036.85X		HIT-TC	20W	G8,5

Con reattore elettronico / With electronic ballast

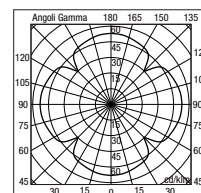
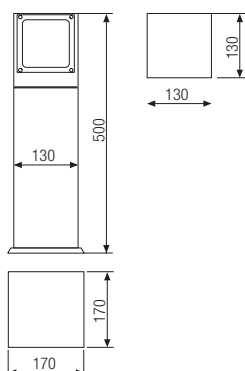

3036 85



3038 H 800

3038.00X		A60	60W	E27
3038.83X		TC-T	26W	GX24 d-3
3038.85X		HIT-TC	20W	G8,5

Con reattore elettronico / With electronic ballast

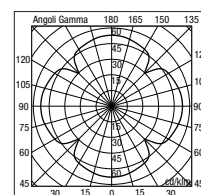
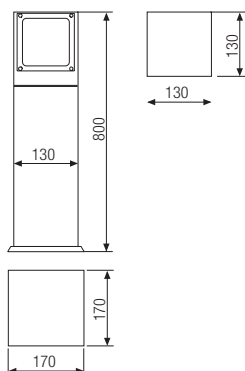

3038 85



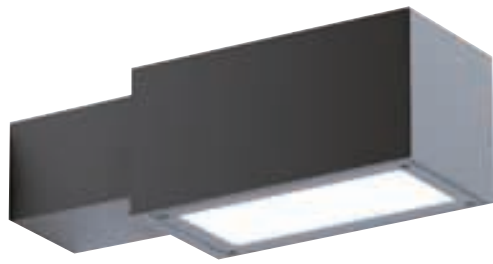

SHARP



SHARP

Apparecchio da esterni per installazione a parete o a terra, disponibili con luci bidirezionali o monodirezionali costituito da:

- Corpo in alluminio pressofuso verniciato
- Diffusore in vetro satinato
- Parabola riflettente in alluminio
- Guarnizioni in silicone
- Viti di chiusura in acciaio inox
- Verniciatura in polveri poliestere ad elevata resistenza ai raggi ultravioletti e alla corrosione

Wall or ground outdoor luminaire, available with mono-direction or double-direction light constructed of:

- Painted die-cast aluminium body
- Satin glass diffuser
- Aluminium reflector
- Silicon gaskets
- Stainless steel screws
- Painting using high resistance to UV and corrosion polyester powders



Colori - Colours

X=2 Bianco
White

X=3 Nero
Black

X=9 Antracite
Anthracite

X=4 Silver

Diffusore - Diffuser

Codice-Code 00 7021

Le lampadine vengono fornite solo su richiesta

Bulbs supplied only on request

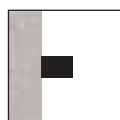

7021 - 7022
Installazione a parete
Wall mounting

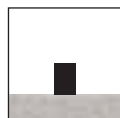

7024 - 7025
Installazione a terra
Floor mounting

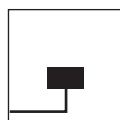

Entrata singola cavi di alimentazione
Single power supply cables input

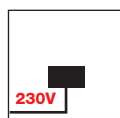

LED - art. 7021.88X - 7022.88X - 7024.88X art. 7025.88X
Led a tensione di rete 220/240V 50Hz.
Connessione diretta alla rete di alimentazione senza necessità di trasformatore.
LED's direct operation at 220/240V 50Hz.
No transformer is required.

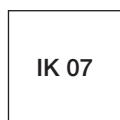

IK 07

Direttiva/Directive
EuP/ErP (2005/52/CE-2009/125/CE)

Gli apparecchi per lampade a scarica ad alta intensità sono progettati per lampade chiare e opali.

Luminaires for high intensity discharge lamps are designed for either clear and coated lamps.



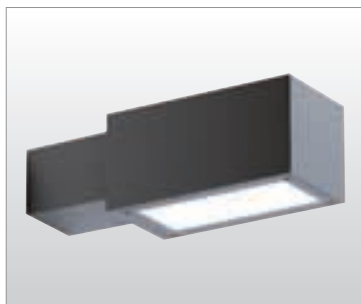

7021 - 7022

Installazione a parete

Wall mounting



Monodirezionale

Mono-directional

7021.95X		TC-DEL	26W	G24 q-3
Con reattore elettronico / With electronic ballast				
7021.85X		HIT-TC	20W	G8,5
Con reattore elettronico / With electronic ballast				
7021.88X		2LED bianco/white	8,2W	460 lm 6000 K

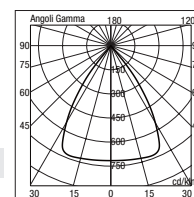

7021 85



Bidirezionale

Double-directional

7022.95X		TC-DEL	26W	G24 q-3
Con reattore elettronico / With electronic ballast				
7022.85X		HIT-TC	20W	G8,5
Con reattore elettronico / With electronic ballast				
7022.88X		4LED bianco/white	2X8,2W	2X460 lm 6000 K

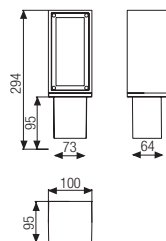

7024 - 7025

Installazione a terra

Floor mounting



Monodirezionale

Mono-directional

7025.95X		TC-DEL	26W	G24 q-3
Con reattore elettronico / With electronic ballast				
7025.85X		HIT-TC	20W	G8,5
Con reattore elettronico / With electronic ballast				
7025.88X		2LED bianco/white	8,2W	460 lm 6000 K

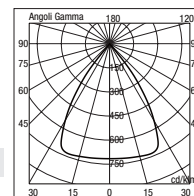

7025 85

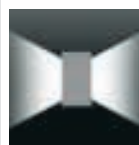

Bidirezionale

Double-directional

7024.95X		TC-DEL	26W	G24 q-3
Con reattore elettronico / With electronic ballast				
7024.85X		HIT-TC	20W	G8,5
Con reattore elettronico / With electronic ballast				
7024.88X		4LED bianco/white	2X8,2W	2X460 lm 6000 K

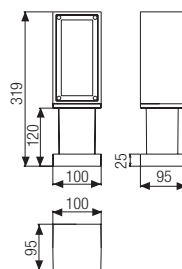





BLUES BIG

BLUES MINI



BLUES BIG

Apparecchio da parete per illuminazione di esterni costituito da:

- Corpo in alluminio pressofuso verniciato
- Diffusore in vetro temperato e/o lente
- Parabola riflettente in alluminio
- Guarnizioni in silicone
- Viti di chiusura in acciaio inox
- Verniciatura in polveri poliestere ad elevata resistenza ai raggi ultravioletti e alla corrosione

Outdoor direct light wall luminaire constructed of:

- Painted die-cast aluminium body
- Tempered glass and/or lens diffuser
- Aluminium reflector
- Silicon gaskets
- Stainless steel screws
- Painting using high resistance to UV and corrosion polyester powders



Colori - Colours

X=2  Bianco
White

X=3  Nero
Black

X=9  Antracite
Anthracite

X=4  Silver

Diffusore - Diffuser

Codice-Code 00 8081 vetro / glass

Codice-Code 04 8083 lente / lens

Le lampadine vengono fornite solo su richiesta

Bulbs supplied only on request

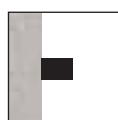

Installazione a parete

Wall mounting

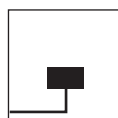

Entrata singola cavi di alimentazione

Single power supply cables input



IK 05

Direttiva/Directive
EuP/ErP (2005/52/CE-2009/125/CE)

Gli apparecchi per lampade a scarica ad alta intensità sono progettati per lampade chiare e opali.

Luminaires for high intensity discharge lamps are designed for either clear and coated lamps.



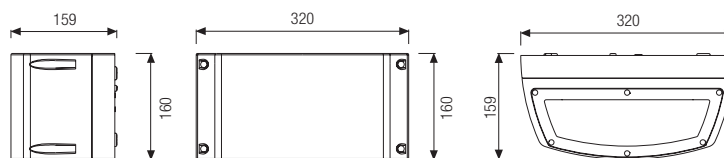

8081

Monodirezionale
Mono direction light

8081.00X		A60	2x60W	E27
8081.95X		TC-D	2x26W	G24 d-3
8081.78X		HIT-DE	70W	Rx7s
8081.76X		QT-DE 12	200W	R7s-15

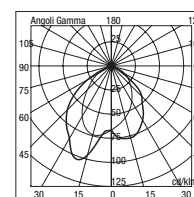

8081 95

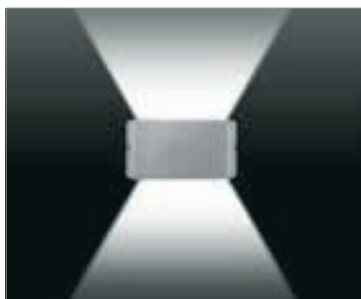

8082

Bidirezionale
Double direction light

8082.00X		A60	2x60W	E27
8082.95X		TC-D	2x26W	G24 d-3
8082.78X		HIT-DE	70W	Rx7s
8082.76X		QT-DE 12	200W	R7s-15

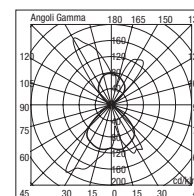

8082 78



8083

Bidirezionale con 1 lente a fascio stretto e 1 vetro
Double direction light with 1 narrow light beam lens and 1 glass

8083.77X		HIT	70W	G12
-----------------	--	-----	-----	-----

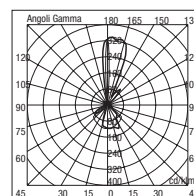

8083 77

BLUES MINI

Apparecchio da parete per illuminazione di esterni costituito da:

- Corpo in alluminio pressofuso verniciato
- Diffusore in vetro temperato e/o lente
- Parabola riflettente in alluminio
- Guarnizioni in silicone
- Viti di chiusura in acciaio inox
- Verniciatura in polveri poliestere ad elevata resistenza ai raggi ultravioletti e alla corrosione

Outdoor direct light wall luminaire constructed of:

- Painted die-cast aluminium body
- Tempered glass and/or lens diffuser
- Aluminium reflector
- Silicon gaskets
- Stainless steel screws
- Painting using high resistance to UV and corrosion polyester powders



Colori - Colours

X=2  Bianco
White

X=3  Nero
Black

X=9  Antracite
Anthracite

X=4  Silver

Diffusore - Diffuser

Codice-Code 00 8071 vetro / glass

Codice-Code 04 8073 lente / lens

Le lampadine vengono fornite solo su richiesta

Bulbs supplied only on request

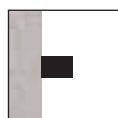

Installazione a parete

Wall mounting

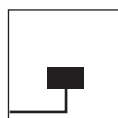

Entrata singola cavi di alimentazione

Single power supply cables input

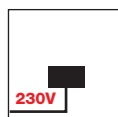

LED - art. 8071.88X - 8072.88X - 8073.88X
art. 8074.88X - 8077.88X

Led a tensione di rete 220/240V 50Hz.

Connessione diretta alla rete di alimentazione senza necessità di trasformatore.

LED's direct operation at 220/240V 50Hz.

No transformer is required.

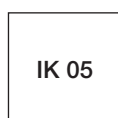

IK 05

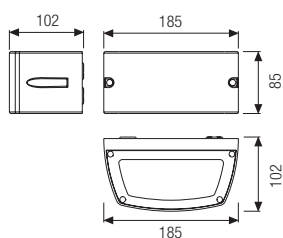

8071

Monodirezionale
Mono direction light

8071.92X		TC-D	13W	G24 d-1
8071.14X		QT14 Halopin	75W	G9
8071.76X		QT-DE 12	60W	R7s-15
8071.88X		1LED bianco/white	4,1W	230 lm 6300 K

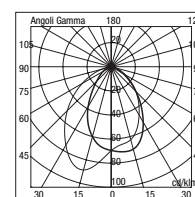

8071 92



8072

Bidirezionale
Double direction light

8072.92X		TC-D	13W	G24 d-1
8072.14X		QT14 Halopin	75W	G9
8072.76X		QT-DE 12	60W	R7s-15
8072.88X		2LED bianco/white	2x4,1W	2x230 lm 6300 K

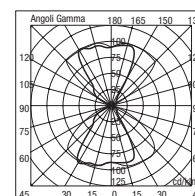

8072 14



8073

Bidirezionale con 1 lente a fascio stretto e 1 vetro
Double direction light with 1 narrow light beam lens and 1 glass

8073.14X		QT14 Halopin	75W	G9
8073.88X		2LED bianco/white	2x4,1W	2x230 lm 6300 K

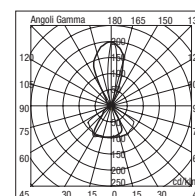

8073 14

BLUES MINI

BLUES MINI

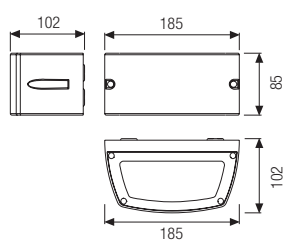

8074

Bidirezionale con 2 lenti a fascio stretto

Double direction light with 2 narrow light beam lenses

8074.14X		QT14 Halopin	75W	G9	
8074.88X		2LED bianco/white	2x4,1W	2x230 lm	6300 K

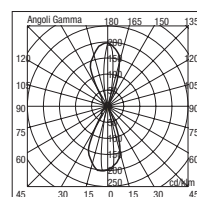

8074 14



8077

Monodirezionale con 1 lente a fascio stretto

Mono direction light with 1 narrow light beam lens

8077.14X		QT14 Halopin	75W	G9	
8077.88X		1LED bianco/white	4,1W	230lm	6300K

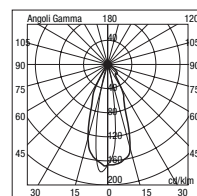

8077 14







AMOS BIG

AMOS MINI



AMOS BIG

Apparecchio a parete per illuminazione di esterni ad emissione di luce con varie aperture di fasci luminosi costituito da:

- Struttura in alluminio pressofuso verniciato
- Vetri piani temperati e/o lenti
- Parabola riflettente in alluminio
- Guarnizioni in silicone
- Viti di chiusura in acciaio inox
- Verniciatura in polveri poliestere ad elevata resistenza ai raggi ultravioletti e alla corrosione

Wall outdoor luminaire with various light band openings constructed of:

- Painted die-cast aluminium structure
- Tempered glasses or/and lenses
- Aluminium reflector
- Silicon gasket
- Stainless steel screws
- Painting using high resistance to UV and corrosion polyester powders



Colori - Colours

X=2 Bianco
White

X=3 Nero
Black

X=9 Antracite
Anthracite

X=4 Silver

Diffusore - Diffuser

Codice-Code 00 8021
vetro / glass

Codice-Code 04 8022
lente tonda / round lens

Codice-Code 04 8023
lente rettangolare / rectangular lens

Le lampadine vengono fornite solo su richiesta

Bulbs supplied only on request

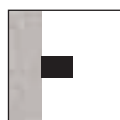

Installazione a parete
Wall mounting

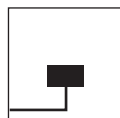

Entrata singola cavi di alimentazione
Single power supply cables input

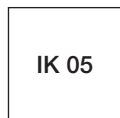

IK 05

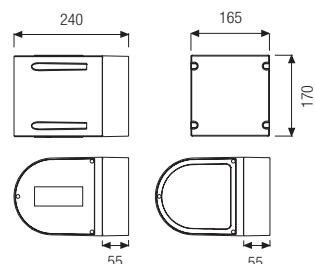

HIT 35W G12

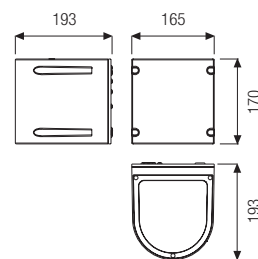

	A60	100W	E27
	TC-T	26W	GX24 d-3
	QT32	100W	E27

Direttiva/Directive

EuP/ErP (2005/52/CE-2009/125/CE)

Gli apparecchi per lampade a scarica ad alta intensità sono progettati per lampade chiare e opali.

Luminaires for high intensity discharge lamps are designed for either clear and coated lamps.



8021

Monodirezionale
Mono direction light

8021.00X		A60	100W	E27
8021.83X		TC-T	26W	GX24 d-3
8021.10X		QT32	100W	E27
8021.35X		HIT	35W	G12

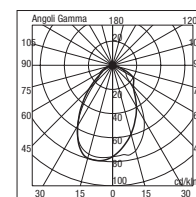

8021 83



8022

Bidirezionale con una lente e un vetro
Double direction light with 1 lens and 1 glass

8022.00X		A60	100W	E27
8022.83X		TC-T	26W	GX24 d-3
8022.10X		QT32	100W	E27
8022.35X		HIT	35W	G12

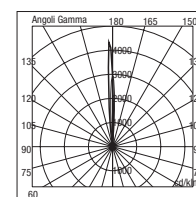

8022 35



8024

Bidirezionale con 2 lenti
Double direction light with 2 lenses

8024.10X		QT32	100W	E27
8024.35X		HIT	35W	G12

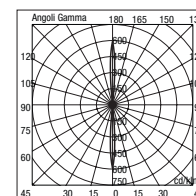

8024 35



8023

Bidirezionale con 1 lente a fascio stretto e un vetro
Double direction light with 1 narrow light beam lens and 1 glass

8023.10X		QT32	100W	E27
8023.35X		HIT	35W	G12

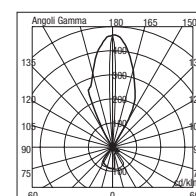

8023 35

AMOS MINI

Apparecchio da parete per illuminazione di interni e di esterni ad emissione di luce con varie aperture di fasci luminosi costituito da:

- Struttura in alluminio pressofuso verniciato
- Vetri piani temperati e/o lenti
- Parabola riflettente in alluminio
- Guarnizioni in silicone
- Viti di chiusura in acciaio inox
- Verniciatura in polveri poliestere ad elevata resistenza ai raggi ultravioletti e alla corrosione

Wall outdoor and indoor luminaire with various light beams constructed of:

- Painted die-cast aluminium structure
- Tempered glasses or/and lenses
- Aluminium reflector
- Silicon gaskets
- Stainless steel screws
- Painting using high resistance to UV and corrosion polyester powders

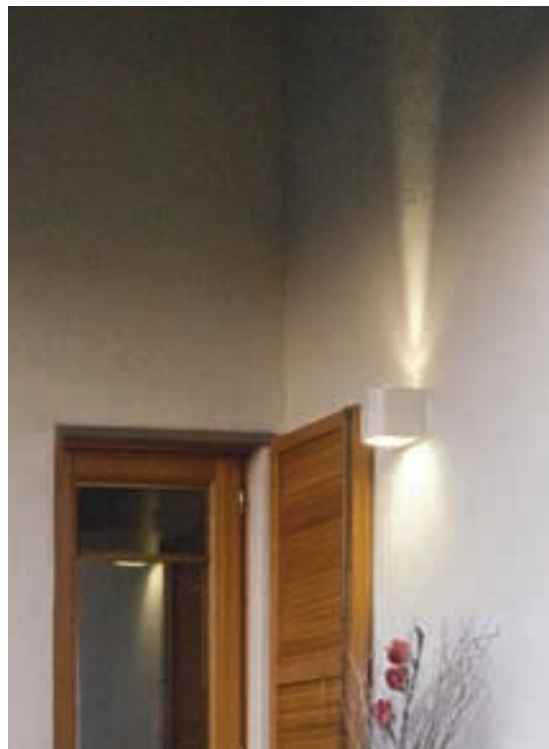

Colori - Colours

X=2  Bianco
White

X=3  Nero
Black

X=9  Antracite
Anthracite

X=4  Silver

Diffusore - Diffuser

Codice-Code 00 8091

vetro / glass

Codice-Code 04 8093

lente rettangolare / rectangular lens

Le lampadine vengono fornite solo su richiesta ad eccezione della versione T2 6W e 60 LED

Bulbs supplied only on request except for T2 6W and 60 LED version



Installazione a parete

Wall mounting

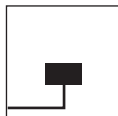

Entrata singola cavi di alimentazione

Single power supply cables input

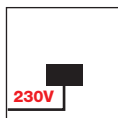

LED - art. 8091.88X - 8092.88X - 8093.88X

Led a tensione di rete 220/240V 50Hz.

Connessione diretta alla rete di alimentazione senza necessità di trasformatore.

LED's direct operation at 220/240V 50Hz.

No transformer is required.

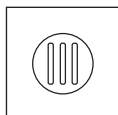

Fluorescente 6W Gx53

Non necessita di alcun alimentatore.

Fluorescent lamp 6W Gx53

Does not need the power supplier

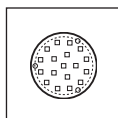

60 LED Gx53

Non necessita di alcun alimentatore.

60 LED Gx53

Does not need the power supplier

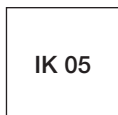

IK 05

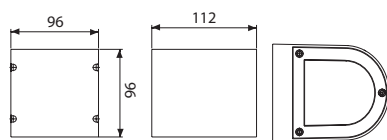

8091

Monodirezionale con un vetro
Mono direction light with one glass

8091.15X		QPAR16	35W	GU10	
• 8091.60X		T2	6W	Gx53	
• 8091.68X		60LED bianco/white	4W	Gx53	260 lm 4000 K
8091.88X		1LED bianco/white	4,1W		230 lm 6300 K

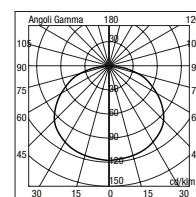

8091 60



8092

Bidirezionale con due vetri
Double direction light with two glasses

8092.14X		QT14	60W	G9	
8092.88X		2LED bianco/white	2x4,1W		2x230 lm 6300 K

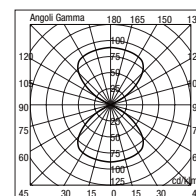

8092 14



8093

Bidirezionale con una lente e un vetro
Double direction light with 1 lens and 1 glass

8093.14X		QT14	60W	G9	
8093.88X		2LED bianco/white	2x4,1W		2x230 lm 6300 K

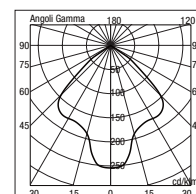

8093 14

- L'apparecchio viene fornito completo di lampadina
Bulb enclosed to the luminaire





BOX

DIXIE STELO



DIXIE



BOX

Apparecchio da parete per illuminazione di interni e di esterni ad emissione di luce con varie aperture di fasci luminosi costituito da:

- Struttura in alluminio pressofuso verniciato
- Vetri piani temperati e/o lenti
- Parabola riflettente in alluminio
- Guarnizioni in silicone
- Viti di chiusura in acciaio inox
- Verniciatura in polveri poliestere ad elevata resistenza ai raggi ultravioletti e alla corrosione

Wall outdoor and indoor luminaire with various light beams constructed of:

- Painted die-cast aluminium structure
- Tempered glasses or/and lenses
- Aluminium reflector
- Silicon gasket
- Stainless steel screws
- Painting using high resistance to UV and corrosion polyester powders



Colori - Colours

X=9  Antracite
Anthracite

X=4  Silver

Diffusore - Diffuser

Codice-Code 00 6041 vetro / glass

Codice-Code 04 6045 lente / lens

Le lampadine vengono fornite solo su richiesta

Bulbs supplied only on request

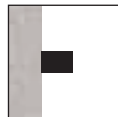

Installazione a parete

Wall mounting

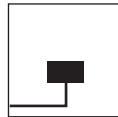

Entrata singola cavi di alimentazione

Single power supply cables input



IK 07

Direttiva/Directive
EuP/ErP (2005/52/CE-2009/125/CE)

Gli apparecchi per lampade a scarica ad alta intensità sono progettati per lampade chiare e opali.

Luminaires for high intensity discharge lamps are designed for either clear and coated lamps.

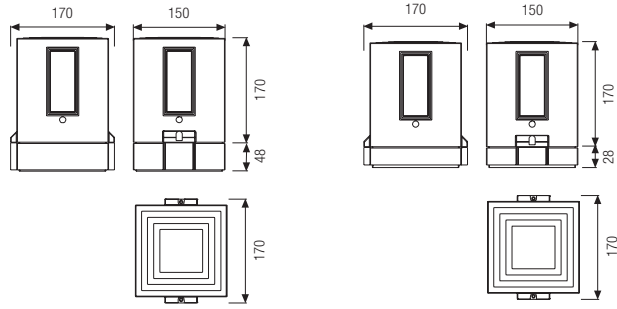

HIT 35W G12

QT32 100W E27

TC-T 26W GX24 d-3



6041

1 fascio luminoso a 40°
1 40° light beam

6041.10X QT32 100W E27

6041.83X TC-T 26W GX24 d-3

6041.35X HIT 35W G12

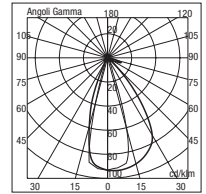

6041 10



6042

2 fasci luminosi a 40°
2 40° light beams

6042.10X QT32 100W E27

6042.83X TC-T 26W GX24 d-3

6042.35X HIT 35W G12

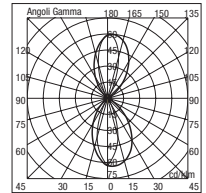

6042 83



6044

4 fasci luminosi a 40°
4 40° light beams

6044.10X QT3 100W E27

6044.83X TC-T 26W GX24 d-3

6044.35X HIT 35W G12

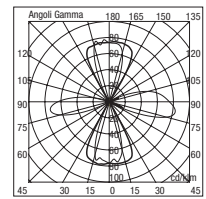

6044 35

BOX

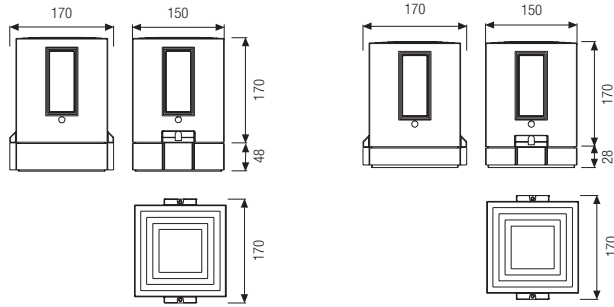

HIT 35W G12

QT32 100W E27
 TC-T 26W GX24 d-3



6043

bidirezionale con 1 lente fascio stretto e 1 fascio luminoso a 40°
 double direction light with 1 narrow light beam lens and 1 40° light beam

6043.10X QT32 100W E27
6043.35X HIT 35W G12

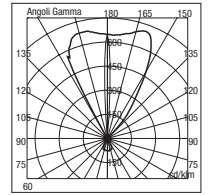

6043 35



6045

monodirezionale con 1 lente fascio stretto
 mono direction light with 1 narrow light beam lens

6045.10X QT32 100W E27
6045.35X HIT 35W G12

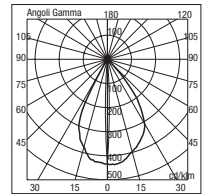

6045 35



6046

bidirezionale con 2 lenti fascio stretto
 double direction light with 2 narrow light beam lenses

6046.10X QT32 100W E27
6046.35X HIT 35W G12

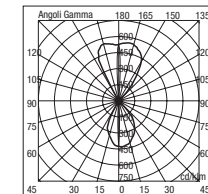



6046 35



6048

4 lenti fascio stretto
4 narrow light beam lenses

6048.10X		QT32	100W	E27
6048.35X		HIT	35W	G12

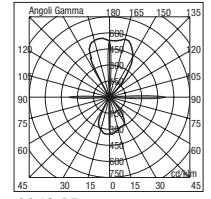

6048 35

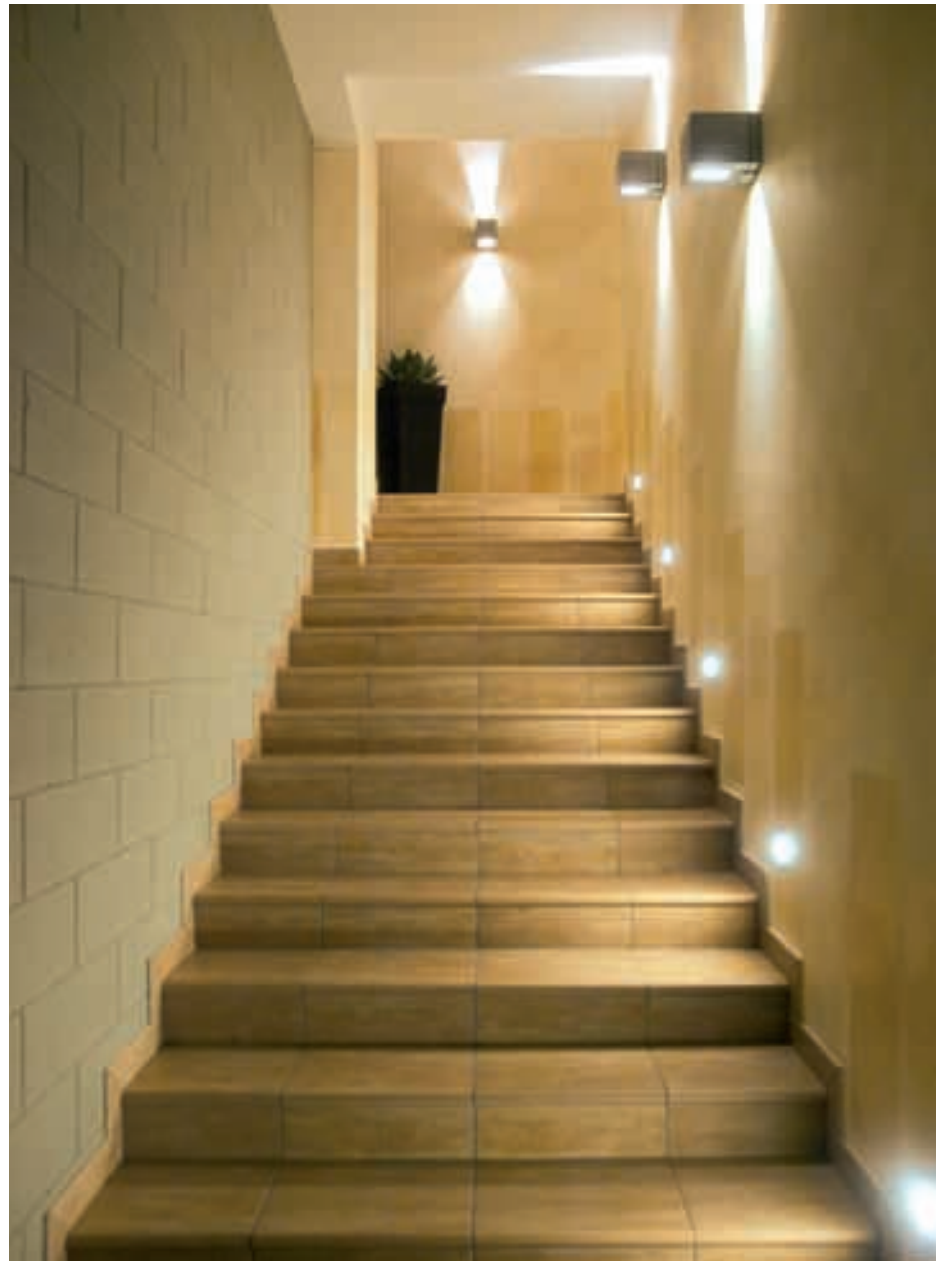

DIXIE

Apparecchio per illuminazione di esterni applicabile a parete costituito da:

- Struttura in alluminio pressofuso verniciato
- Vetro satinato temperato o in policarbonato opale
- Parabola riflettente in alluminio
- Guarnizioni in silicone
- Viti di chiusura in acciaio inox
- Verniciatura in polveri poliestere ad elevata resistenza ai raggi ultravioletti e alla corrosione

Outdoor wall luminaire constructed of:

- Painted die-cast aluminium structure
- Satin tempered glass or opal polycarbonate diffuser
- Aluminium reflector
- Silicon gaskets
- Stainless steel screws
- Painting using high resistance to UV and corrosion polyester powders



DIXIE STELO

Piantana da giardino per esterni. Costituita da:

- Palo in alluminio estruso verniciato
- Corpo superiore in alluminio pressofuso verniciato

Garden post luminaire constructed of:

- Painted extruded aluminium post
- Painted die-cast aluminium head



Colori - Colours

- X=2 Bianco / White
- X=3 Nero / Black
- X=9 Antracite / Anthracite
- X=4 Silver

Diffusore - Diffuser

Codice-Code 00 7071
vetro / glass

Codice-Code 08 7071
policarbonato/polycarbonate

Su richiesta disponibile anche con diffusore in policarbonato
Available also with polycarbonate diffuser on request

Le lampadine vengono fornite solo su richiesta
Bulbs supplied only on request

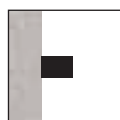

DIXIE
Installazione a parete
Wall mounting



DIXIE STELO
Installazione a terra
Floor mounting

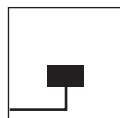

Entrata singola cavi di alimentazione
Single power supply cables input

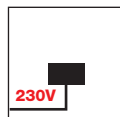

LED - art. 7071.88X - 7072.88X
Led a tensione di rete 220/240V 50Hz.
Connessione diretta alla rete di alimentazione senza necessità di trasformatore.
LED's direct operation at 220/240V 50Hz.
No transformer is required.

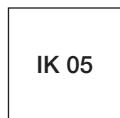

Diffusore vetro
Glass diffuser



Diffusore policarbonato
Polycarbonate diffuser



ACCESSORIO: art. PT76
Questo accessorio serve per chiudere una o più uscite di luce secondo le esigenze di installazione
This part is used to close one or more light openings as for the installation's necessities

Direttiva/Directive

EuP/ErP (2005/52/CE-2009/125/CE)

Gli apparecchi per lampade a scarica ad alta intensità sono progettati per lampade chiare e opali.

Luminaires for high intensity discharge lamps are designed for either clear and coated lamps.

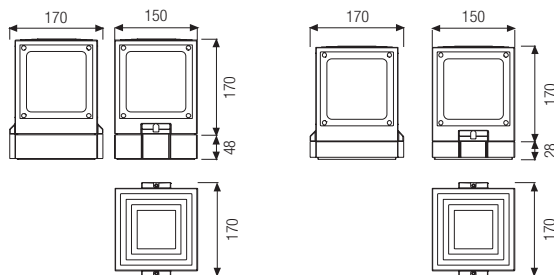

- HIT 35W G12
- A60 100W E27
- TC-T 26W GX24 d-3
- QT32 150W E27
- LED 4,1W



7071

1 apertura
1 opening

7071.00X		A60	100W	E27
7071.83X		TC-T	26W	GX24 d-3
7071.10X		QT32	150W	E27
7071.35X		HIT	35W	G12
7071.88X		2LED bianco/white	8,2W	460 lm 6300 K

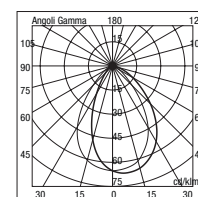

7071 10



7072

2 aperture
2 openings

7072.00X		A60	100W	E27
7072.83X		TC-T	26W	GX24 d-3
7072.10X		QT32	150W	E27
7072.35X		HIT	35W	G12
7072.88X		4LED bianco/white	2x8,2W	2x460 lm 6300 K

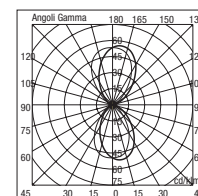

7072 83

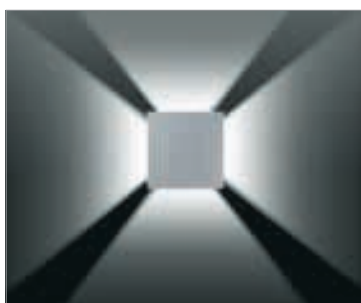

7074

4 aperture
4 openings

7074.00X		A60	100W	E27
7074.83X		TC-T	26W	GX24 d-3
7074.10X		QT32	150W	E27
7074.35X		HIT	35W	G12

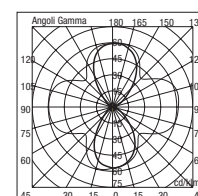

7074 35



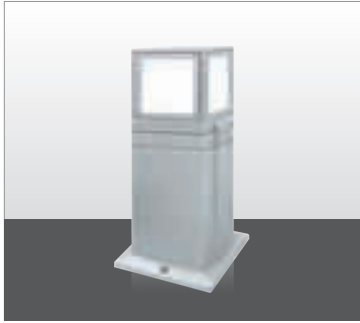

DIXIE STELO

DIXIE STELO



7077 H 330/350

4 aperture
4 openings

7077.00X		A60	100W	E27
7077.83X		TC-T	26W	GX24 d-3
7077.10X		QT32	150W	E27
7077.35X		HIT	35W	G12

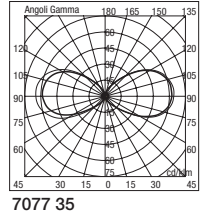



7077 35



7076 H 700/720

4 aperture
4 openings

7076.00X		A60	100W	E27
7076.83X		TC-T	26W	GX24 d-3
7076.10X		QT32	150W	E27
7076.35X		HIT	35W	G12

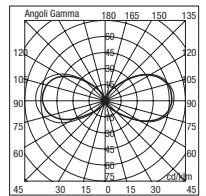



7076 35



7078 H 1000/1020

4 aperture
4 openings

7078.00X		A60	100W	E27
7078.83X		TC-T	26W	GX24 d-3
7078.10X		QT32	150W	E27
7078.35X		HIT	35W	G12

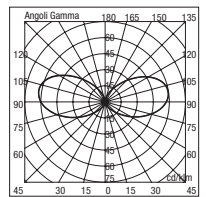



7078 83

DIXIE STELO

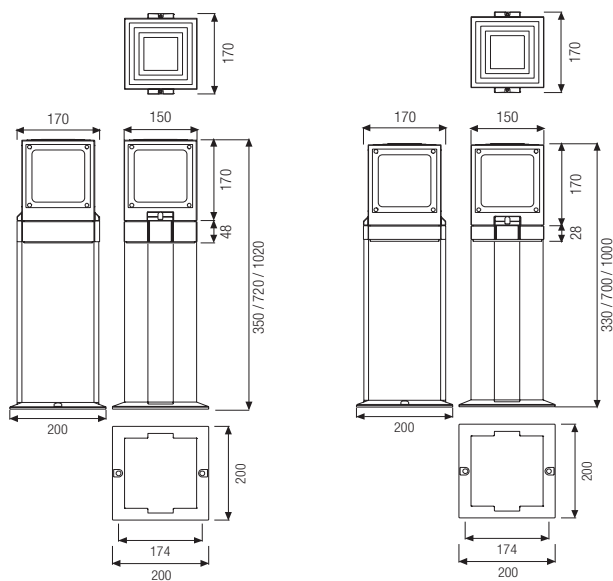
DIXIE STELO



 HIT 35W G12

 A60 100W E27
 TC-T 26W GX24 d-3
 QT32 150W E27



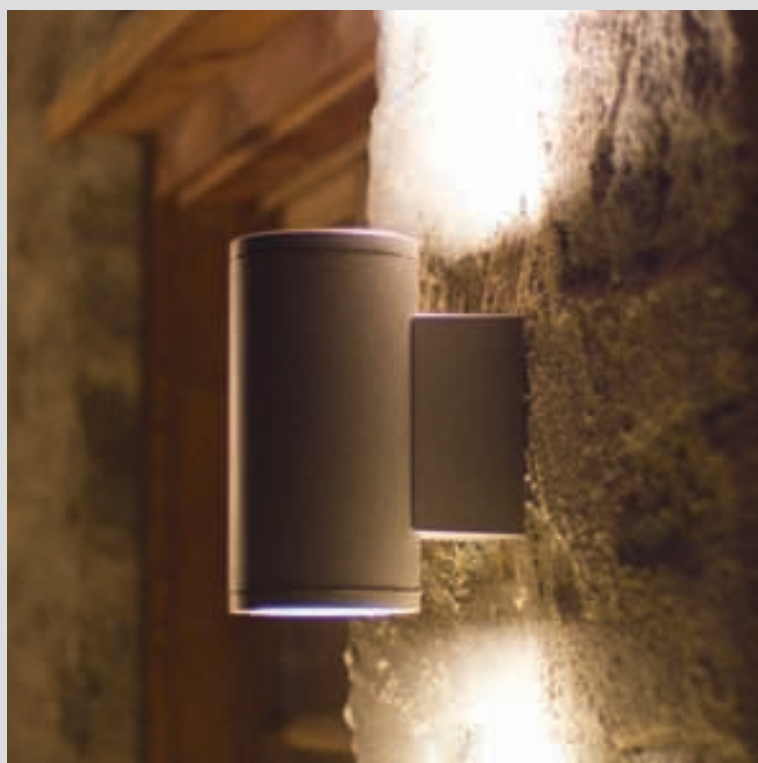



N 07



BLITZ



BLITZ QUAD

N 07

Proiettore orientabile per esterni ed interni applicabile a parete costituito da:

- Corpo in alluminio pressofuso verniciato
- Diffusore in vetro temperato satinato
- Guarnizioni in silicone
- Viti di chiusura in acciaio inox
- Verniciatura in polveri poliestere ad elevata resistenza ai raggi ultravioletti e alla corrosione

Adjustable indoor and outdoor wall spotlight constructed of:

- Painted die-cast aluminium body
- Satin glass diffuser
- Silicon gaskets
- Stainless steel screws
- Painting using high resistance to UV and corrosion polyester powders



Colori - Colours

X=9  Anthracite
Anthracite

X=4  Silver

Diffusore - Diffuser

Codice-Code 00 9070

Le lampadine vengono fornite solo su richiesta

Bulbs supplied only on request

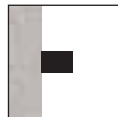

Installazione a parete
Wall mounting

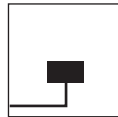

Entrata singola cavi di alimentazione
Single power supply cables input

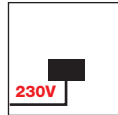

LED - art. 9070.88X
Led a tensione di rete 220/240V 50Hz.
Connessione diretta alla rete di alimentazione senza necessità di trasformatore.
LED's direct operation at 220/240V 50Hz.
No transformer is required.

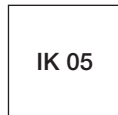

IK 05

APPARECCHIO ORIENTABILE DA 0° A 90°

ADJUSTABLE FROM 0° TO 90°



9070



9070.15X		Q PAR16	50W	GU10	
9070.88X		1 LED bianco/white	4,1W	230lm	6300K

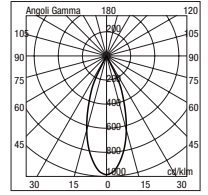
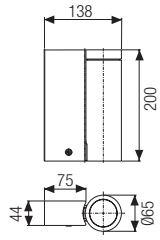

9070 15

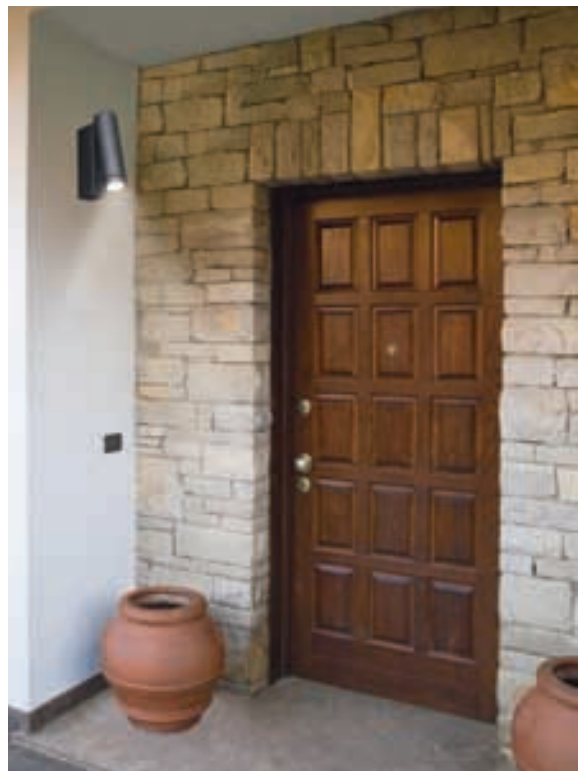

BLITZ

Apparecchio a sezione cilindrica a parete o a soffitto per esterni a uno o a due fasci luminosi; è disponibile in diverse dimensioni. È costituito da:

- Corpo in alluminio estruso e in alluminio pressofuso verniciato
- Diffusore in vetro temperato
- Parabola riflettente in alluminio
- Guarnizioni in silicone
- Viti di chiusura in acciaio inox
- Verniciatura in polveri poliestere ad elevata resistenza ai raggi ultravioletti e alla corrosione

One or two light beams outdoor wall or ceiling cylindrical section luminaire available in different sizes. It is constructed of:

- Extruded or die-casted aluminium body
- Tempered glass diffuser
- Aluminium reflector
- Silicon gaskets
- Stainless steel screws
- Painting using high resistance to UV and corrosion polyester powders



Colori - Colours

X=2 Bianco
White

X=3 Nero
Black

X=9 Antracite
Anthracite

X=4 Silver

Diffusore - Diffuser

Codice-Code 00 9061
00 9071

Le lampadine vengono fornite solo su richiesta

Bulbs supplied only on request

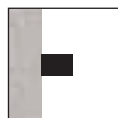

Installazione a parete
Wall mounting

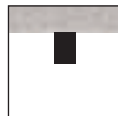

9067 - 9077
Installazione a soffitto
Ceiling mounting

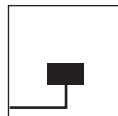

Entrata singola
cavi di alimentazione
Single power supply
cables input

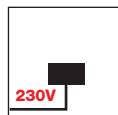

LED - art. 9071.88X - 9072.88X - 9075.88X
art. 9076.88X - 9077.88X
Led a tensione di rete 220/240V 50Hz.
Connessione diretta alla rete di alimentazione
senza necessità di trasformatore.
LED's direct operation at 220/240V 50Hz.
No transformer is required.

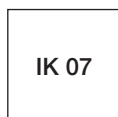

IK 07

Direttiva/Directive
EuP/ErP (2005/52/CE-2009/125/CE)

Gli apparecchi per lampade a scarica ad alta intensità sono progettati per lampade chiare e opali.

Luminaires for high intensity discharge lamps are designed for either clear and coated lamps.



9075 - 9076



Monodirezionale
Mono direction light

9075.15X		Q PAR16	50W	GU10	
9075.88X		1 LED bianco/white	4,1W	230 lm	6300 K

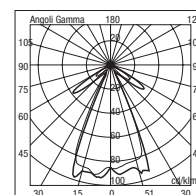

9075 15



Bidirezionale
Double direction light

9076.14X		QT14	60W	G9	
9076.88X		2 LED bianco/white	2x4,1W	2x230 lm	6300 K

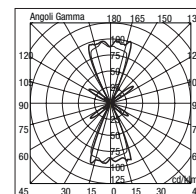

9076 14

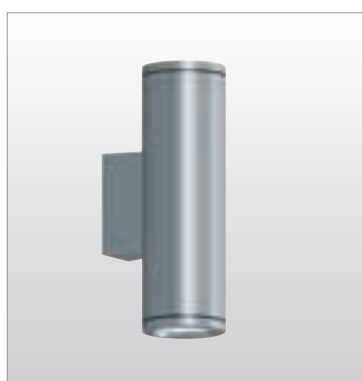
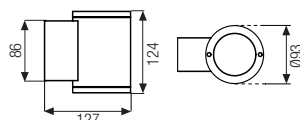

9071 - 9072



Monodirezionale
Mono direction light

9071.15X		Q PAR16	50W	GU10	
9071.88X		1 LED bianco/white	4,1W	230lm	6300K

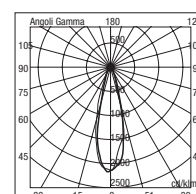

9071 15



Bidirezionale
Double direction light

9072.15X		Q PAR16	2x50W	GU10	
9072.88X		2 LED bianco/white	2x4,1W	2x230lm	6300K

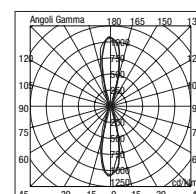

9072 15

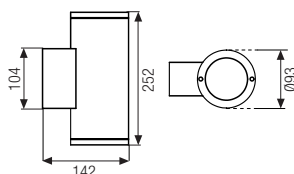

9077 a soffitto/ceiling mounting



Monodirezionale
Mono direction light

9077.15X		Q PAR16	50W	GU10	
9077.88X		1 LED bianco/white	4,1W	230 lm	6300 K

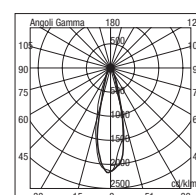

9077 15

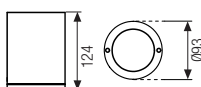

BLITZ Ø130

BLITZ Ø130



9061 - 9064



Monodirezionale
Mono direction light

- 9061.00X** Q PAR30 75W E27
 - 9061.83X** TC-T 26W Gx24 d-3
 - 9061.35X** HIT 35W G12
- Con reattore elettronico / With electronic ballast
- 9061.81X** TC-TEL 32-42W Gx24 q-3-4
- Con reattore elettronico / With electronic ballast

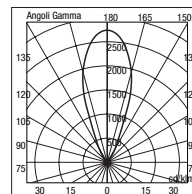

9061 00



Bidirezionale
Double direction light

- 9064.35X** HIT 1x35W G12
- Con reattore elettronico / With electronic ballast

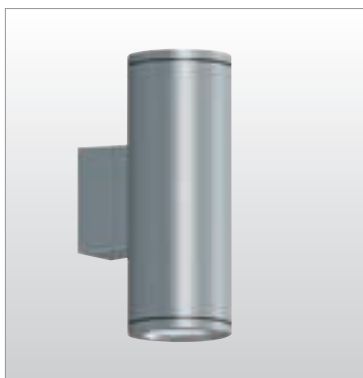
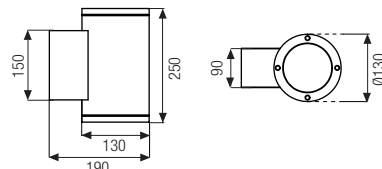

9062



Bidirezionale
Double direction light

- 9062.00X** Q PAR30 2x75W E27
 - 9062.95X** TC-TEL 2x26W GX 24 q-3
 - 9062.35X** HIT 2x35W G12
- Con reattore elettronico / With electronic ballast

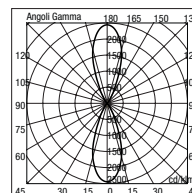

9062 00

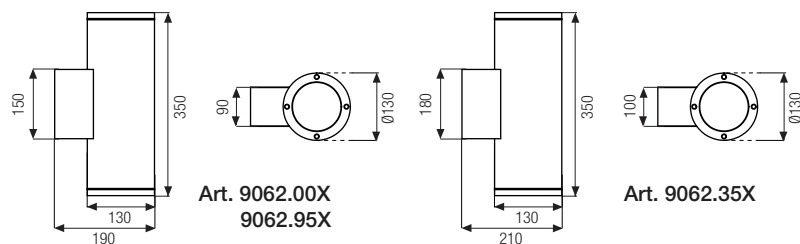

9067 a soffitto/ceiling mounting



Monodirezionale
Mono direction light

- 9067.00X** Q PAR30 75W E27
- 9067.35X** HIT 35W G12

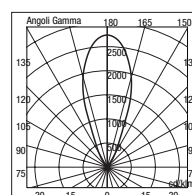
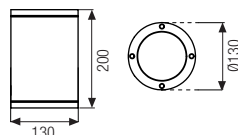

9067 00



BLITZ QUAD

Apparecchio a sezione quadrata a parete o a soffitto per esterni a uno o a due fasci luminosi; è disponibile in diverse dimensioni. È costituito da:

- Corpo in alluminio estruso e in alluminio pressofuso verniciato
- Diffusore in vetro temperato
- Parabola riflettente in alluminio
- Guarnizioni in silicone
- Viti di chiusura in acciaio inox
- Verniciatura in polveri poliestere ad elevata resistenza ai raggi ultravioletti e alla corrosione

One or two light beams outdoor wall or ceiling square section luminaire available in different sizes. It is constructed of:

- Extruded or die-casted aluminium body
- Tempered glass diffuser
- Aluminium reflector
- Silicon gaskets
- Stainless steel screws
- Painting using high resistance to UV and corrosion polyester powders



Colori - Colours

- X=2 Bianco
White
- X=3 Nero
Black
- X=9 Antracite
Anthracite
- X=4 Silver

Diffusore - Diffuser

Codice-Code 00 9015
00 9025
00 9085
00 9095

Le lampadine vengono fornite solo su richiesta ad eccezione della versione T2 6W e 60 LED
Bulbs supplied only on request except for T2 6W and 60 LED version

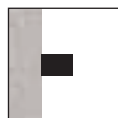

Installazione a parete
Wall mounting



art. 9087 - 9097
Installazione a soffitto
Ceiling mounting

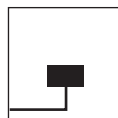

Entrata singola
cavi di alimentazione
Single power supply
cables input

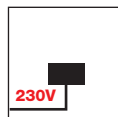

LED - art. 9015.88X - 9016.88X - 9017.88X
art. 9018.88X - 9085.88X - 9086.88X
art. 9087.88X - 9095.88X - 9096.88X
art. 9097.88X - 9098.88X

Led a tensione di rete 220/240V 50Hz.
Connessione diretta alla rete di alimentazione
senza necessità di trasformatore.
LED's direct operation at 220/240V 50Hz.
No transformer is required.

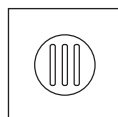

Fluorescente 6W Gx53
Non necessita di alcun alimentatore.
Fluorescent lamp 6W Gx53
Does not need the power supplier

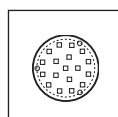

60 LED Gx53
Non necessita di alcun alimentatore.
60 LED Gx53
Does not need the power supplier



IK 07

Direttiva/Directive
EuP/ErP (2005/52/CE-2009/125/CE)

Gli apparecchi per lampade a scarica ad alta intensità sono progettati per lampade chiare e opali.
Luminaires for high intensity discharge lamps are designed for either clear and coated lamps.



9015 - 9016 ☐ 80



Monodirezionale

Mono direction light

9015.15X		Q PAR16	50W	GU10
9015.88X		1 LED bianco/white	4,1W	230 lm 6300 K

Bidirezionale

Double direction light

9016.14X		QT14 Halopin	60W	G9
9016.88X		2 LED bianco/white	2x4,1W	2x230 lm 6300 K

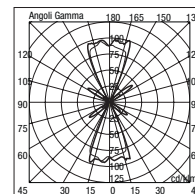
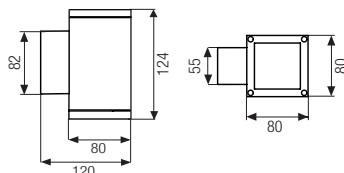

9016 14



9017 - 9018 ☐ 80



Monodirezionale

Mono direction light

9017.15X		Q PAR16	50W	GU10
9017.88X		1 LED bianco/white	4,1W	230 lm 6300 K

Bidirezionale

Double direction light

9018.15X		Q PAR16	2x50W	GU10
9018.88X		2 LED bianco/white	2x4,1W	2x230 lm 6300 K

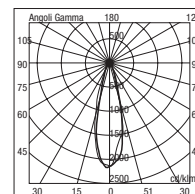
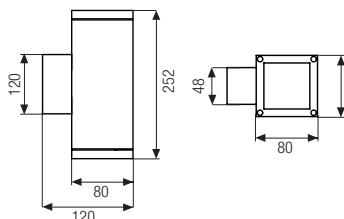

9017 15



9085 - 9086 ☐ 100

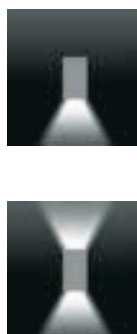

Monodirezionale

Mono direction light

9085.15X		Q PAR16	50W	GU10
● 9085.60X		T2	6W	Gx53
● 9085.68X		60LED bianco/whit	4W	Gx53 260 lm 4000 K
9085.88X		1LED bianco/white	4,1W	230 lm 6300 K

Bidirezionale

Double direction light

● 9086.60X		T2	2x6W	Gx53
● 9086.68X		60LED bianco/whit	2x4W	Gx53 2x260 lm 4000 K
9086.88X		2LED bianco/white	2x4,1W	2x230 lm 6300 K

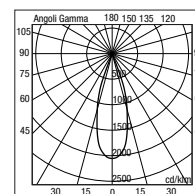
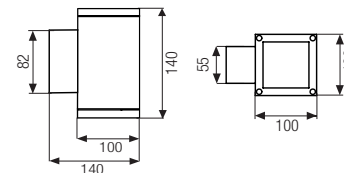

9085 15



9088 ☐ 100



Bidirezionale

Double direction light

9088.15X		Q PAR16	2x50W	GU10
9088.88X		2LED bianco/white	2x4,1W	2x230 lm 6300 K

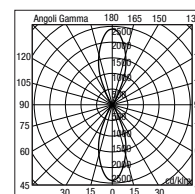
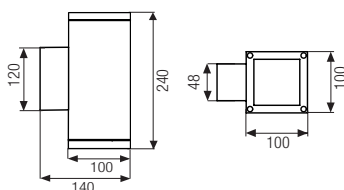

9088 15

- L'apparecchio viene fornito completo di lampadina
Bulb enclosed to the luminaire

BLITZ QUAD

BLITZ QUAD



9094 - 9095 ☐ 130



Monodirezionale
Mono direction light

9095.00X Q PAR30 75W E27

9095.83X TC-T 26W GX24 d-3

9095.35X HIT 35W G12

Con reattore elettronico / With electronic ballast

9095.88X 2LED bianco/white 8,2W 460 lm 6300 K

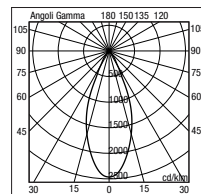

9095 00



Bidirezionale
Double direction light

9094.35X HIT 1x35W G12

Con reattore elettronico / With electronic ballast

9094.88X 4LED bianco/white 2x8,2W 2x460 lm 6300 K

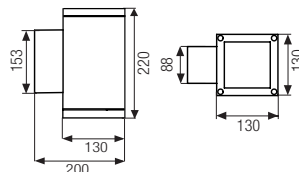

9096 ☐ 130



Bidirezionale
Double direction light

9096.00X Q PAR30 2x75W E27

9096.83X TC-TEL 2x26W GX24 q-3

Con reattore elettronico / With electronic ballast

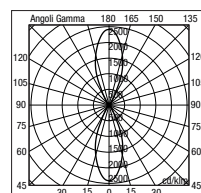
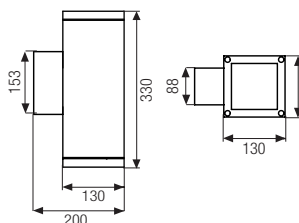

9096 00

A SOFFITTO / CEILING MOUNTING



9097 ☐ 130



Monodirezionale
Mono direction light

9097.00X Q PAR30 75W E27

9097.88X 2LED bianco/white 8,2W 460 lm 6300 K

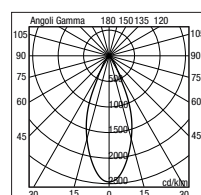
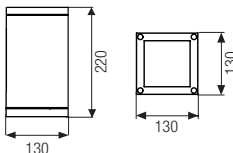

9097 00



9024 - 9025 □ 150



Monodirezionale Mono direction light

● 9025.00X		Q PAR30	75W	E27
● 9025.83X		TC-T	26W	GX24 d-3
● 9025.35X		HIT	35W	G12
● 9025.77X		HIT	70W	G12
● 9025.81X		TC-TEL	26-32-42W	GX24 q-3-4

● Con reattore elettronico / With electronic ballast

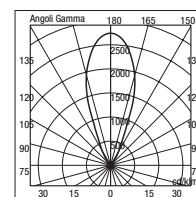

9025 00



Bidirezionale Double direction light

● 9024.77X		HIT	1x70W	G12
------------	--	-----	-------	-----

● Con reattore elettronico / With electronic ballast

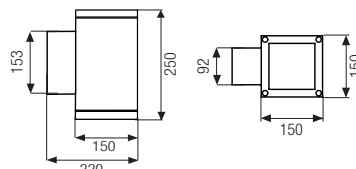

9026 □ 150



Bidirezionale Double direction light

● 9026.00X		Q PAR30	2x75W	E27
● 9026.83X		TC-TEL	2x26W	GX24 q-3
● 9026.35X		HIT	2x35W	G12

● Con reattore elettronico / With electronic ballast

● Con reattore elettronico / With electronic ballast

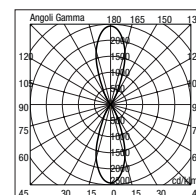

9026 00

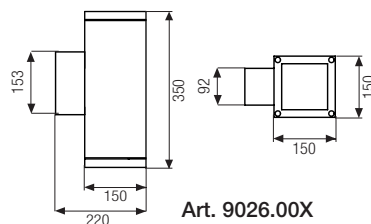

Art. 9026.00X
9026.95X

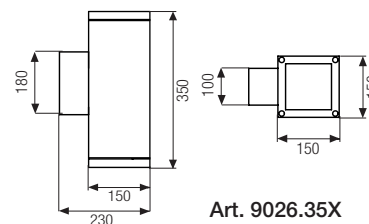

Art. 9026.35X

A SOFFITTO / CEILING MOUNTING



9087 □ 100



Monodirezionale Mono direction light

● 9087.15X		Q PAR16	50W	GU10
● 9087.88X		1LED bianco/white	4,1W	230 lm 6300 K

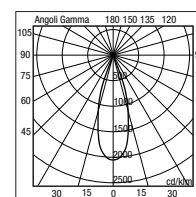
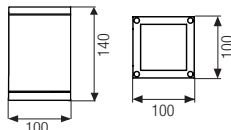

9087 15

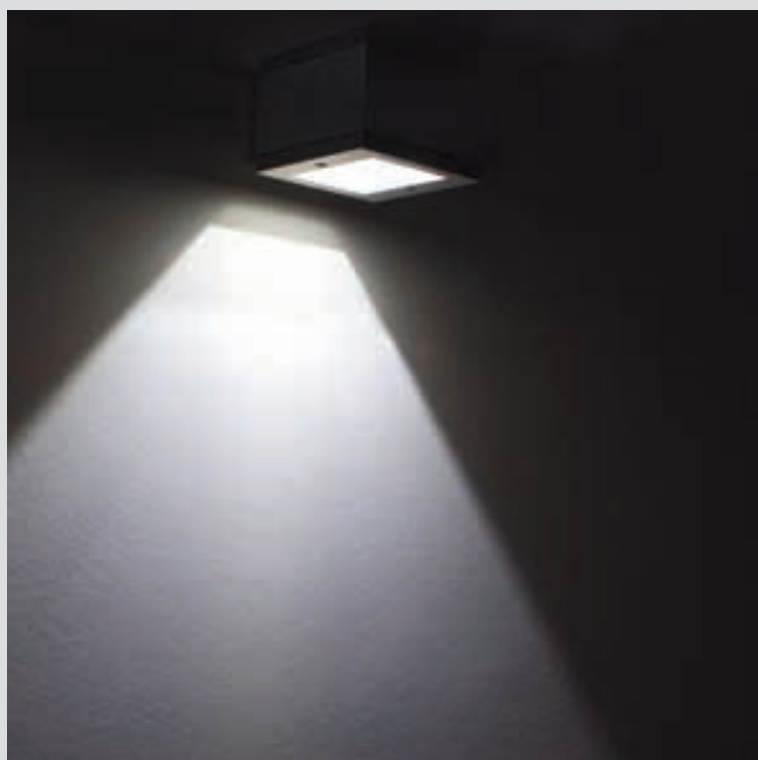



HALF

HALF

Apparecchio per esterni a parete o a soffitto.

Disponibile in due dimensioni:

HALF 130

HALF 150

È costituito da:

- Corpo in alluminio estruso e in alluminio pressofuso verniciato
- Diffusore in vetro temperato
- Parabola riflettente in alluminio
- Guarnizioni in silicone
- Viti di chiusura in acciaio inox
- Verniciatura in polveri poliestere ad elevata resistenza ai raggi ultravioletti e alla corrosione

Outdoor wall or ceiling luminaire

available in 2 different sizes:

HALF 130

HALF 150

It is constructed of:

- Extruded or die-casted aluminium body
- Tempered glass diffuser
- Aluminium reflector
- Silicon gaskets
- Stainless steel screws
- Painting using high resistance to UV and corrosion polyester powders



Colori - Colours

X=2 Bianco
White

X=3 Nero
Black

X=9 Antracite
Anthracite

X=4 Silver

Diffusore - Diffuser

Codice-Code 00 7012

00 7014

00 7017

00 7027

Le lampadine vengono fornite solo su richiesta ad eccezione della versione T2 6W e 60 LED

Bulbs supplied only on request except for T2 6W and 60 LED version

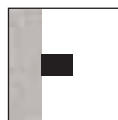

Installazione a parete

Wall mounting

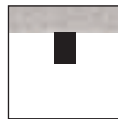

art. 7017 - 7027

Installazione a soffitto

Ceiling mounting

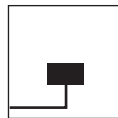

**Entrata singola
cavi di alimentazione**

Single power supply
cables input

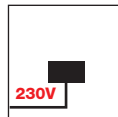

LED - art. 7011.88X - 7012.88X - 7013.88X

art. 7014.88X - 7017.88X - 7027.88X

Led a tensione di rete 220/240V 50Hz.

Connessione diretta alla rete di alimentazione senza necessità di trasformatore.

LED's operation at 220/240V 50Hz voltage directly. No transformer is required.

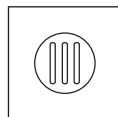

Fluorescente 6W Gx53

Non necessita di alcun alimentatore.

Fluorescent lamp 6W Gx53

Does not need the power supplier

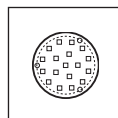

60 LED Gx53

Non necessita di alcun alimentatore.

60 LED Gx53

Does not need the power supplier



IK 07

Direttiva/Directive

EuP/ErP (2005/52/CE-2009/125/CE)

Gli apparecchi per lampade a scarica ad alta intensità sono progettati per lampade chiare e opali.

Luminaires for high intensity discharge lamps are designed for either clear and coated lamps.



7011 - 7012 HALF 130

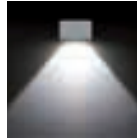

Monodirezionale
Mono direction light

7011.14X		QT14	75W	G9	
• 7011.60X		T2	6W	Gx53	
• 7011.68X		60LED bianco/white	4W	Gx53	260 lm 4000 K
7011.88X		2 LED bianco/white	8,2W		460 lm 6300 K



Bidirezionale
Double direction light

7012.14X		QT14	1x75W	G9	
• 7012.60X		T2	2x6W	Gx53	
• 7012.68X		60LED bianco/white	2x4W	Gx53	2x260 lm 4000 K
7012.88X		4 LED bianco/white	2x8,2W		2x460 lm 6300 K

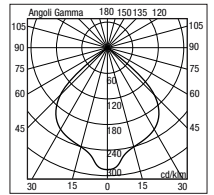

7011.14

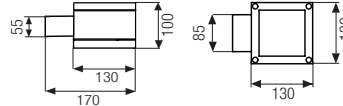

7017 HALF 130 a soffitto/ceiling mounting

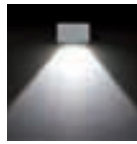

Monodirezionale
Mono direction light

7017.14X		QT14	75W	G9	
7017.88X		2 LED bianco/white	8,2W		460 lm 6300 K

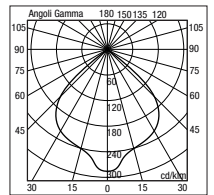
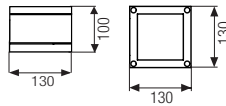

7017.14



7013 - 7014 HALF 150

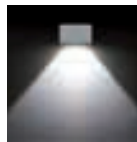

Monodirezionale
Mono direction light

7013.92X		TC-DE	13W	G24 q-1	
Con reattore elettronico / With electronic ballast					
7013.85X		HIT-TC	20W	G8,5	
Con reattore elettronico / With electronic ballast					
7013.88X		2 LED bianco/white	8,2W		460 lm 6300 K



Bidirezionale
Double direction light

7014.88X		4 LED bianco/white	2x8,2W		920 lm 6300 K
-----------------	--	--------------------	--------	--	---------------

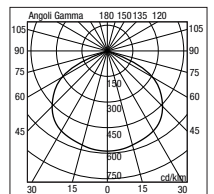
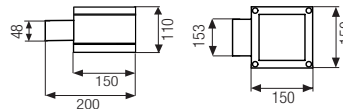

7013.85



7027 HALF 150 a soffitto/ceiling mounting

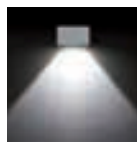

Monodirezionale
Mono direction light

7027.85X		HIT-TC	20 W	G8,5	
Con reattore elettronico / With electronic ballast					
7027.88X		2 LED bianco/white	8,2W		460 lm 6300 K

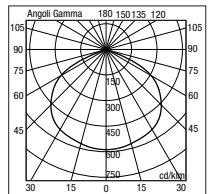
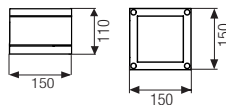

7027.85

- L'apparecchio viene fornito completo di lampadina
Bulb enclosed to the luminaire

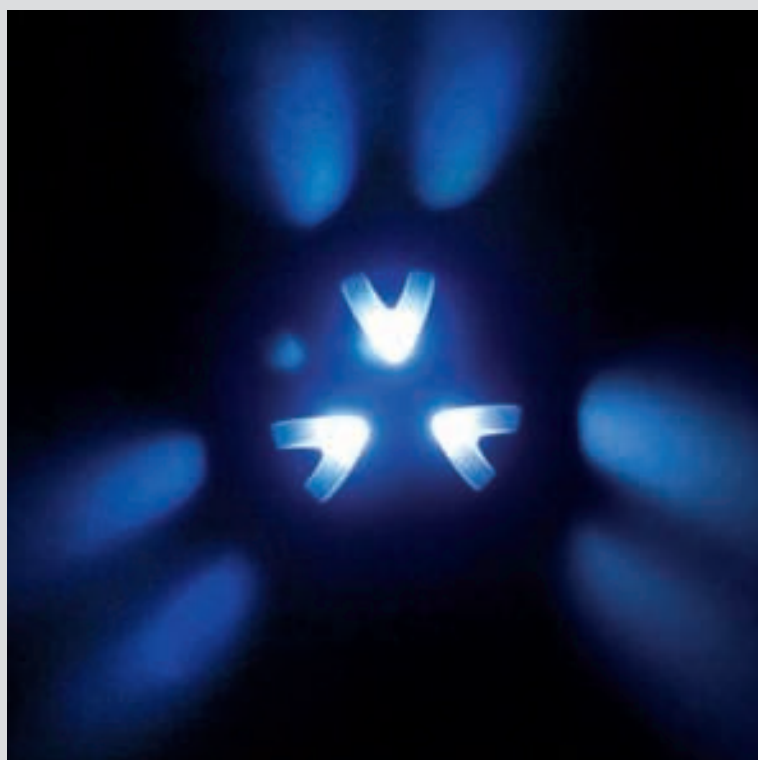



SIX

SIX

Apparecchio da incasso a terra carrabile o a parete per esterni, con **TECNOLOGIA LED**. È ideale come luce da camminamento. È costituito da:

- Corpo in alluminio pressofuso
- Diffusore in vetro satinato temperato
- Guarnizione in silicone
- Viti di chiusura in acciaio inox
- Controcassa in tecnopolimero
- Verniciatura in polveri poliestere ad elevata resistenza ai raggi ultravioletti e alla corrosione

Outdoor recessed drive-over ground or wall luminaire with LED TECHNOLOGY. It is ideal as light for walkways.

It is constructed of:

- Painted die-cast aluminium body
- Satin tempered glass diffuser
- Silicon gaskets
- Stainless steel screws
- Technopolymer holder
- Painted using high resistance to UV and corrosion polyester powders



Colori - Colours

- X=3** Nero
Black
- X=9** Antracite
Anthracite
- X=4** Silver

Diffusore - Diffuser

Codice-Code 00 4011

Gli apparecchi vengono forniti completi di cassaforma

The holder is enclosed to the luminaire

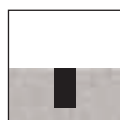

Incasso a terra
Recessed ground version

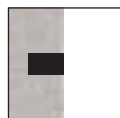

Incasso a parete
Recessed wall version



Versione muro. La cassaforma deve essere installata a filo muro.
Recessed wall version. Holder must be recessed flush with the wall surface

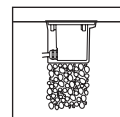

Versione terra. La cassaforma deve essere installata a filo terreno, prevedendo ghiaia di drenaggio per almeno 30 cm.
Recessed ground luminaire. The box must be recessed into the ground providing a drainage-gravel for at least 30 cm

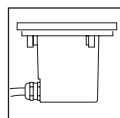

Entrata singola cavi di alimentazione con pressacavi M16 (Ø 5÷10 mm). Usare cavi flessibili. (Cavi rigidi possono compromettere la tenuta stagna IP67).
Single power supply entry cable with M16 cable glands. Use flexible cables (rigid cables may compromise IP 67 rating)

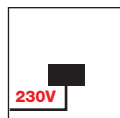

LED - art. 5010.88X
Led a tensione di rete 220/240V 50Hz.
Connessione diretta alla rete di alimentazione senza necessità di trasformatore.
LED's direct operation at 220/240V 50Hz.
No transformer is required.



CS 4010
Cassaforma in tecnopolimero per vano ad incasso Ø mm 110 - h mm 97
Technopolymer holder to be recessed Ø mm 110 h mm 97

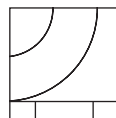

Carico massimo:
Kg 2000 a velocità max 10 Km/h
Maximum load:
Kg 2000 at 10 Km/h max speed



Temperatura superfici toccabili (ta 15°C) : <40°C
Touchable surfaces (ta 15°C) : <40°C

Zona di installazione:
Intended usage:
3

NOTA: zona di installazione definita dalla norma EN 60598-2-13 - Allegato A - Vedi pag. 377
Note: intended usage is defined by the standard EN 60598-2-13 - Annex A - See pag. 377

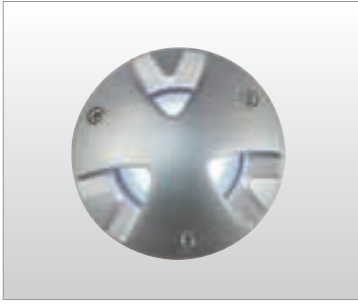

5010

5010.88X 1 LED bianco/white 4,1W 230 lm 6300 K

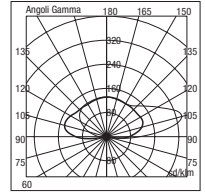

5010 88

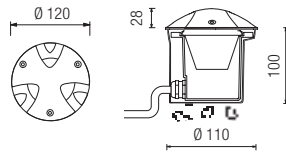
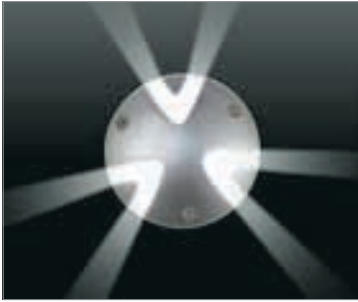

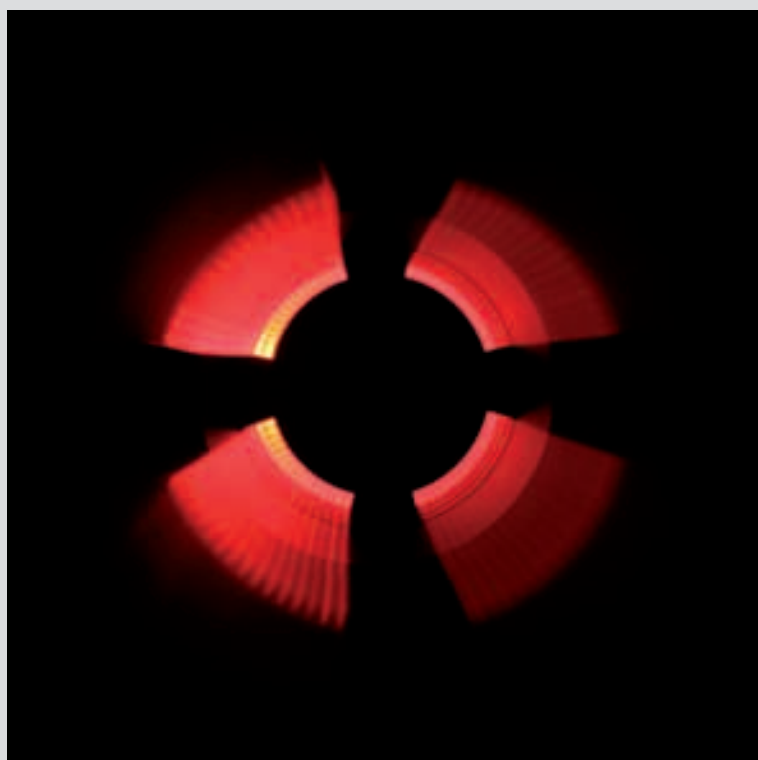



TREK

TREK MINI

Apparecchio da incasso a parete o a terra carrabile, per esterni costituito da:

- Corpo in alluminio pressofuso verniciato
- Diffusore in vetro satinato temperato
- Parabola riflettente in alluminio
- Guarnizione in silicone
- Viti di chiusura in acciaio inox
- Controcassa in tecnopolimero
- Verniciatura in polveri poliestere ad elevata resistenza ai raggi ultravioletti e alla corrosione

Outdoor recessed wall or driveover ground luminaire constructed of:

- Painted die-cast aluminium body
- Satin tempered glass diffuser
- Aluminium reflector
- Silicon gasket
- Stainless steel screws
- Technopolymer holder
- Painting using high resistance to UV and corrosion polyester powders



CL I QT14 / T2 6W / 1LED

CL III QT9 12V

Colori - Colours

- X=3 Nero / Black
- X=9 Antracite / Anthracite
- X=4 Silver

Diffusore - Diffuser

Codice-Code 00 4011

Le lampadine vengono fornite solo su richiesta ad eccezione della versione T2 6W

Bulbs supplied only on request except for T2 6W version

Gli apparecchi vengono forniti completi di cassaforma

The holder is enclosed to the luminaire

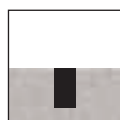

Incasso a terra
Recessed ground version

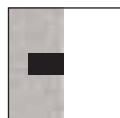

Incasso a parete
Recessed wall version



Versione muro. La cassaforma deve essere installata a filo muro.
Recessed wall version. Holder must be recessed flush with the wall surface

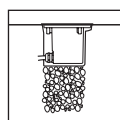

Versione terra. La cassaforma deve essere installata a filo terreno, prevedendo ghiaia di drenaggio per almeno 30 cm.
Recessed ground luminaire. The holder must be recessed into the ground providing a drainage-gravel for at least 30 cm

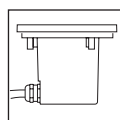

Entrata singola cavi di alimentazione con pressacavi M16 (Ø 5÷10 mm). Usare cavi flessibili. (Cavi rigidi possono compromettere la tenuta stagna IP67).
Single power supply entry cable with M16 cable glands. Use flexible cables (rigid cables may compromise IP 67 rating)

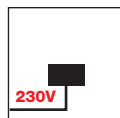

12 LED
L'apparecchio è fornito completo di alimentatore elettronico Full Range 100/240V 50/60Hz posizionato all'interno dell'apparecchio.
The luminaire is supplied with a Full Range 100/240V 50/60Hz built-in transformer

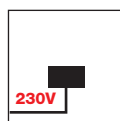

LED - art. 5014.88X - 5015.88X - 5016.88X
Led a tensione di rete 220/240V 50Hz.
Connessione diretta alla rete di alimentazione senza necessità di trasformatore.
LED's direct operation at 220/240V 50Hz. No transformer is required.

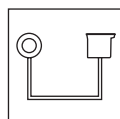

QT9 12V
L'apparecchio va utilizzato con trasformatore remoto 230V/12V posizionato all'inizio della linea di alimentazione.
The feeding transformer (230V-12V) for low voltage must be installed in the remote position

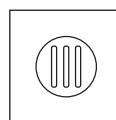

Fluorescente 6W Gx53
Non necessita di alcun alimentatore.
Fluorescent lamp 6W Gx53
Does not need the power supplier

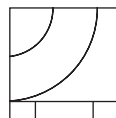

Carico massimo:
Kg 2000 a velocità max 10 Km/h
Maximum load:
Kg 2000 at 10 Km/h max speed



Simbolo che indica la temperatura superficiale sulla calotta T<70°C (dati rilevati a ta per esterni di 15°C)
Cover's surface temperature T<70°C (ambient temperature data of 15°C)

Temperatura calotta (ta 15°C)		Zona di installazione: Intended usage:	
Cover's temperature	(ta 15°C)		
QT9	20W	<40°C	3
QT14	25W	<40°C	3
1LED	4,1W	<40°C	3
12LED	6W	<40°C	3
T2	6W	<40°C	3

NOTA: zona di installazione definita dalla norma EN 60598-2-13 Allegato A - Vedi pag. 377

Note: intended usage is defined by the standard EN 60598-2-13 Annex A - See pag. 377



5015

5015.09X QT9 20W G4 12V

Con trasformatore remoto (non fornito) / Remote transformer (not supplied)

5015.14X QT14 Halopin 25W G9

• **5015.60X** T2 6W Gx53

5015.16X 12LED bianco/white 6W 25 lm 6000 K

5015.88X 1LED bianco/white 4,1W 230 lm 6300 K

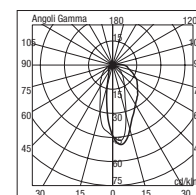
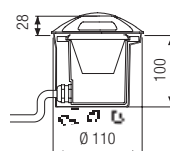
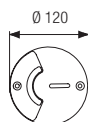
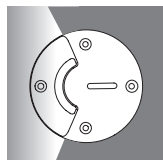

5015 16

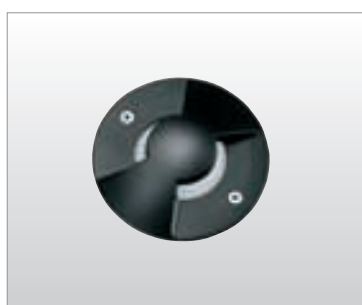

5014

5014.09X QT9 20W G4 12V

Con trasformatore remoto (non fornito) / Remote transformer (not supplied)

5014.14X QT14 Halopin 25W G9

• **5014.60X** T2 6W Gx53

5014.16X 12LED bianco/white 6W 25 lm 6000 K

5014.88X 1LED bianco/white 4,1W 230 lm 6300 K

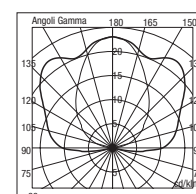
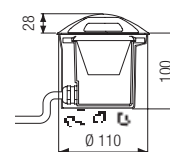
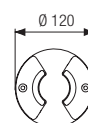
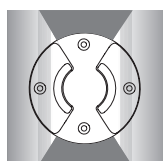

5014 14

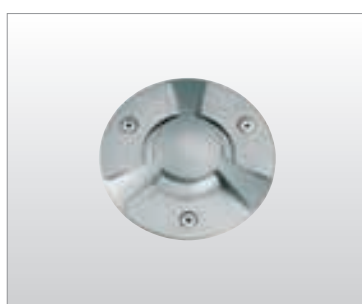

5016

5016.09X QT9 20W G4 12V

Con trasformatore remoto (non fornito) / Remote transformer (not supplied)

5016.14X QT14 Halopin 25W G9

• **5016.60X** T2 6W Gx53

5016.16X 12LED bianco/white 6W 25 lm 6000 K

5016.88X 1LED bianco/white 4,1W 230 lm 6300 K

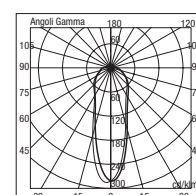
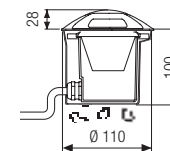
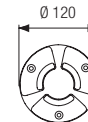
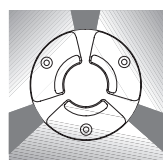

5016 16

- L'apparecchio viene fornito completo di lampadina
Bulb enclosed to the luminaire



CS 4010 per/for QT9-QT14
Cassaforma in tecnopolimero per vano ad incasso Ø mm 110 - h mm 97
Technopolymer holder to be recessed into the wall Ø mm 110 h mm 97



CS 5087 per/for T2 6W
Cassaforma in tecnopolimero per vano ad incasso Ø mm 112/130 - h mm 100
Technopolymer holder to be recessed into the wall Ø mm 112/130 - h mm 100

TREK BIG

Apparecchio da incasso a terra carrabile, per esterni costituito da:

- Corpo in alluminio pressofuso verniciato
- Diffusore in vetro trasparente temperato
- Parabola riflettente in alluminio
- Guarnizione in silicone
- Viti di chiusura in acciaio inox
- Controcassa in polipropilene o in tecnopolimero
- Verniciatura in polveri poliestere ad elevata resistenza ai raggi ultravioletti e alla corrosione

Outdoor recessed driveover ground luminaire constructed of:

- Painted die-cast aluminium body
- Transparent tempered glass diffuser
- Aluminium reflector
- Silicon gasket
- Stainless steel screws
- Polypropylene holder
- Painting using high resistance to UV and corrosion polyester powders



Colori - Colours

- X=3 Nero Black
- X=9 Antracite Anthracite
- X=4 Silver

Diffusore - Diffuser

Codice-Code 00 1050 per/for Cod. 1045 - 1057

Codice-Code 00 5026 per/for Cod. 5024 - 5025 - 5026

Le lampadine vengono fornite solo su richiesta ad eccezione della versione T2 6W e 60 LED Gx53

Bulbs supplied only on request except for version T2 6W and 60 LED Gx53

Gli apparecchi vengono forniti completi di cassaforma
The holder is enclosed to the luminaire

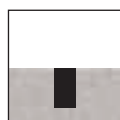

Incasso a terra
Recessed ground version

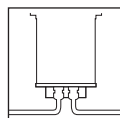

Doppia entrata cavi di alimentazione con pressacavi PG13,5 (ø 6÷12 mm) per cod. 1045 - 1057 e con pressacavi M16 (ø 5÷10 mm) per cod. 5024 - 5025 - 5026. Usare cavi flessibili per non compromettere la tenuta stagna IP67.

Double entrance of the supply cables with gland type PG 13,5 (ø 6÷12 mm) for cod. 1045 - 1057 and with gland type M16 (ø 5÷10 mm) for cod. 5024 - 5025 - 5026. Use only flexible cables to grant protection against water exposure (IP 67)

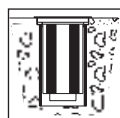

La cassaforma deve essere installata a filo terreno, prevedendo ghiaia di drenaggio per almeno 30 cm.

The holder must be recessed into the ground providing a drainage-gravel for at least 30 cm

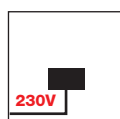

LED - art. 5024.88X - 5025.88X - 5026.88X
Led a tensione di rete 220/240V 50Hz.
Connessione diretta alla rete di alimentazione senza necessità di trasformatore.
LED's direct operation at 220/240V 50Hz.
No transformer is required.

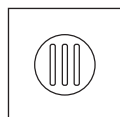

Fluorescente 6W Gx53
Non necessita di alcun alimentatore.
Fluorescent lamp 6W Gx53
Does not need the power supplier

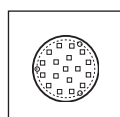

60 LED Gx53
Non necessita di alcun alimentatore.
60 LED Gx53
Does not need the power supplier

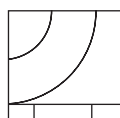

Carico massimo:
Kg 2500 a velocità max 10 Km/h
Maximum load:
Kg 2500 at 10 Km/h max speed



IK 09



Simbolo che indica la temperatura superficiale sulla calotta T<70°C (dati rilevati a ta per esterni di 15°C)
Cover's surface temperature T<70°C (ambient temperature data of 15°C)

Temperatura calotta (ta 15°C)		Zona di installazione:	
Cover's temperature (ta 15°C)		Intended usage:	
C35	60W	60°C	3
TC-D	10W	<40°C	3
TC-T	18W	45°C	3
G9	60W	65°C	3
T2	6W	<40°C	3

NOTA: zona di installazione definita dalla norma EN 60598-2-13 Allegato A - Vedi pag. 377
Note: intended usage is defined by the standard EN 60598-2-13 Annex A - See pag. 377





1057

1057.00X		C35	60W	E14
1057.92X		TC-D	10W	G24 d-1
1057.84X		TC-T	18W	GX24 d-2

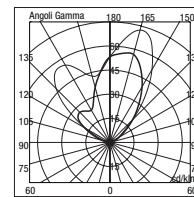
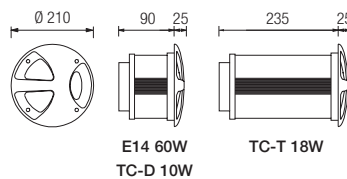
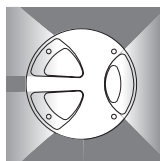

1057 92

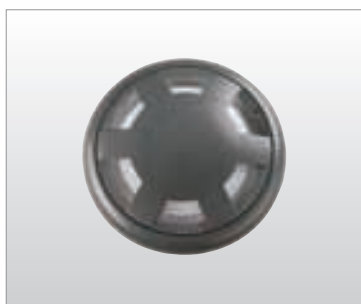

1045

1045.00X		C35	60W	E14
1045.92X		TC-D	10W	G24 d-1
1045.84X		TC-T	18W	GX24 d-2

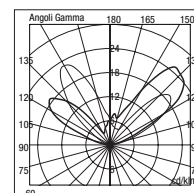
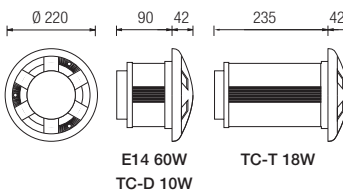
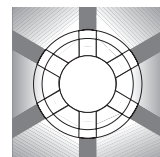

1045 92

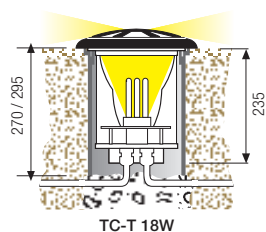

1057.84X h 295
1045.84X h 270

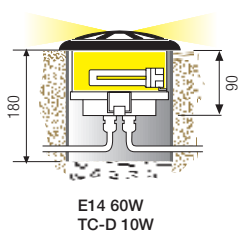

E14 60W
TC-D 10W

1045.00X
1045.92X
1057.00X
1057.92X



Per/for Cod. 1045 - 1057
Pozzetto in polipropilene ø 180 mm
Polypropylene holder Ø 180 mm

h 180 mm **CS1045** per/for Cod. 1045.00X
per/for Cod. 1045.92X

h 180 mm **CS1084** per/for Cod. 1057.00X
per/for Cod. 1057.92X

h 270 mm **CS18** per/for Cod. 1045.84X
h 295 mm **CS2060** per/for Cod. 1057.84X





5025

5025.14X		QT14 Halopin	75W	G9	
5025.92X		TC-D	10W	G24 d-1	
• 5025.60X		T2	6W	Gx53	
• 5025.68X		60LED bianco/white	4W	Gx53	260 lm 4000 K
5025.88X		1LED bianco/white	4,1W		230 lm 6300 K

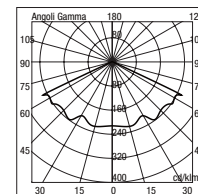
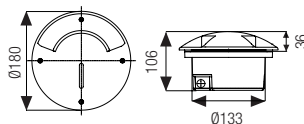
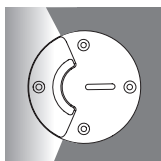

5025 14

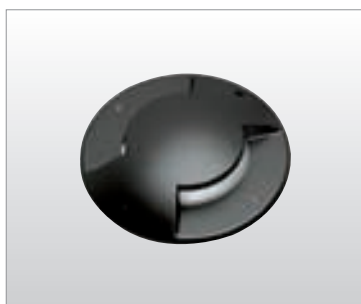

5024

5024.14X		QT14 Halopin	75W	G9	
5024.92X		TC-D	10W	G24 d-1	
• 5024.60X		T2	6W	Gx53	
• 5024.68X		60LED bianco/white	4W	Gx53	260 lm 4000 K
5024.88X		1LED bianco/white	4,1W		230 lm 6300 K

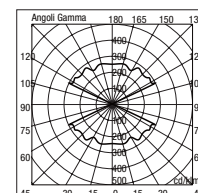
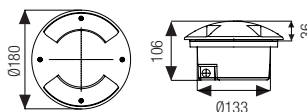
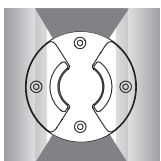

5024 14

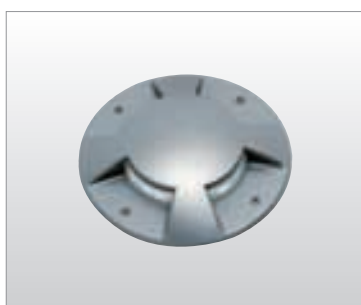

5026

5026.14X		QT14 Halopin	75W	G9	
5026.92X		TC-D	10W	G24 d-1	
• 5026.60X		T2	6W	Gx53	
• 5026.68X		60LED bianco/white	4W	Gx53	260 lm 4000 K
5026.88X		1LED bianco/white	4,1W		230 lm 6300 K

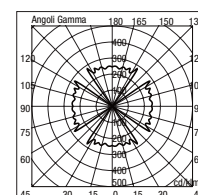
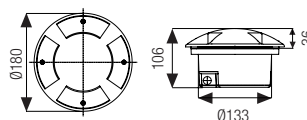

5026 14



CS25
Cassaforma in tecnopolimero per vano ad incasso
Ø mm 170 / 186 - h mm 100
Technopolymer holder to be recessed into the wall
Ø mm 170 / 186 - h mm 100

- L'apparecchio viene fornito completo di lampadina
Bulb enclosed to the luminaire

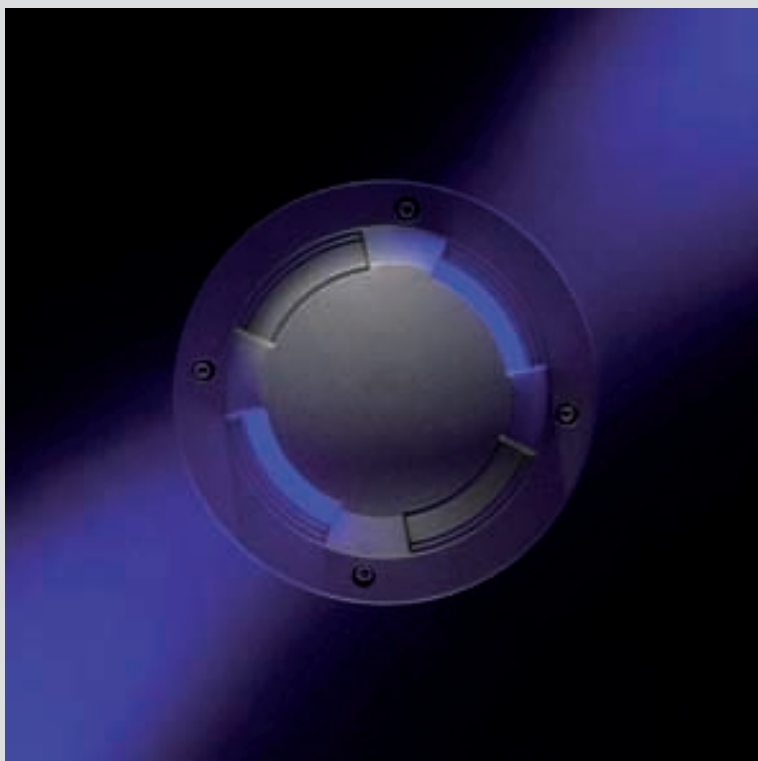



ZED

ZED

Apparecchio da incasso a terra o a muro per illuminazione di esterni costituito da:

- Struttura in alluminio pressofuso verniciato
- Diffusore in vetro trasparente
- Guarnizioni in silicone
- Viti di chiusura in acciaio inox
- Pozzetto in polipropilene per installazione a terra e in tecnopolimero per installazione a muro
- Verniciatura in polveri poliestere ad elevata resistenza ai raggi ultravioletti e alla corrosione

Outdoor recessed ground or wall luminaire constructed of:

- Painted die-cast aluminium body
- Transparent glass diffuser
- Silicon gaskets
- Stainless steel screws
- Polypropylene holder for ground fixing and technopolymer holder for wall fixing
- Painting using high resistance to UV and corrosion polyester powders



Colori - Colours

- X=3 Nero
Black
- X=9 Antracite
Anthracite
- X=4 Silver

Diffusore - Diffuser

Codice-Code 00 5054

Le lampadine vengono fornite solo su richiesta

Bulbs supplied only on request

In fase di ordinazione specificare se l'installazione sarà a terra o a parete

Specify on the order if the ground or the wall version is needed

Gli apparecchi vengono forniti completi di cassaforma

The holder is enclosed to the luminaire

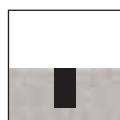

Incasso a terra
Recessed ground version

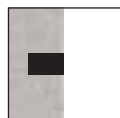

Incasso a parete
Recessed wall version



Versione muro. La cassaforma deve essere installata a filo muro.
Recessed wall version. Holder must be recessed flush with the wall surface

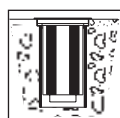

Versione terra. La cassaforma deve essere installata a filo terreno, prevedendo ghiaia di drenaggio per almeno 30 cm.
Ground version. The holder must be recessed into the ground providing a drainage-gravel for at least 30 cm

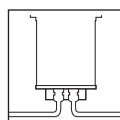

Doppia entrata cavi di alimentazione con pressacavi PG13,5 (ø 6÷12 mm). Usare cavi flessibili per non compromettere la tenuta stagna IP67.
Double entrance of the supply cables with gland type PG 13,5 (ø 6÷12 mm). Use only flexible cables to grant protection against water exposure (IP 67)

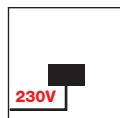

LED - art. 5054.88X - 5056.88X - 5058.88X
Led a tensione di rete 220/240V 50Hz.
Connessione diretta alla rete di alimentazione senza necessità di trasformatore.
LED's operation at 220/240V 50Hz voltage directly. No transformer is required.



IK 07



CS 1084 per installazione a terra
Pozzetto in polipropilene
CS 1084 Polypropylene holder for ground installation only Ø 180 mm - h 180 mm



CS 1085 per installazione a parete
Controcassa in tecnopolimero da incassare nel muro prima dell'installazione della lampada
Ø 185 mm - h. 130 mm.
Non può essere installata a pavimento.
CS 1085 for wall fixing only
Technopolymer holder to be fitted into the wall before the installation of the luminaire
Ø 185 mm - h. 130 mm.
Not to be fitted as a buried uplighter.



5056 4 aperture / 4 openings

5056.00X		A60	75W	E27
5056.84X		TC-T	18W	GX24 d-2
5056.88X		1LED bianco/white	4,1W	230 lm 6300 K

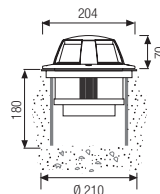
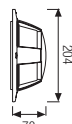
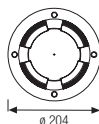

VERSIONE TERRA
GROUND VERSION

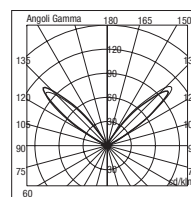

5056 00

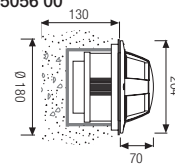

VERSIONE PARETE
WALL VERSION



5054 2 aperture / 2 openings

5054.00X		A60	75W	E27
5054.84X		TC-T	18W	GX24 d-2
5054.88X		1LED bianco/white	4,1W	230 lm 6300 K

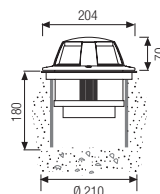
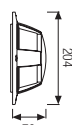
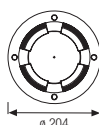
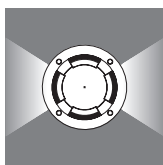

VERSIONE TERRA
GROUND VERSION

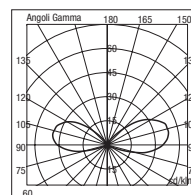

5054 84

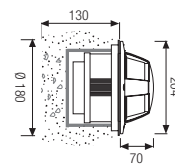

VERSIONE PARETE
WALL VERSION



5058

5058.00X		A60	75W	E27
5058.84X		TC-T	18W	GX24 d-2
5058.88X		1LED bianco/white	4,1W	230 lm 6300 K

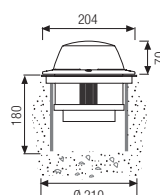
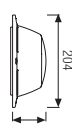
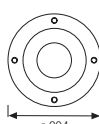
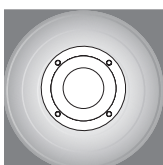

VERSIONE TERRA
GROUND VERSION

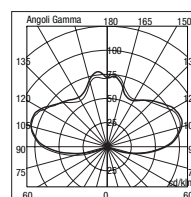

5058 84

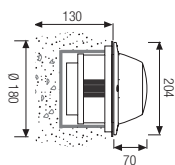

VERSIONE PARETE
WALL VERSION

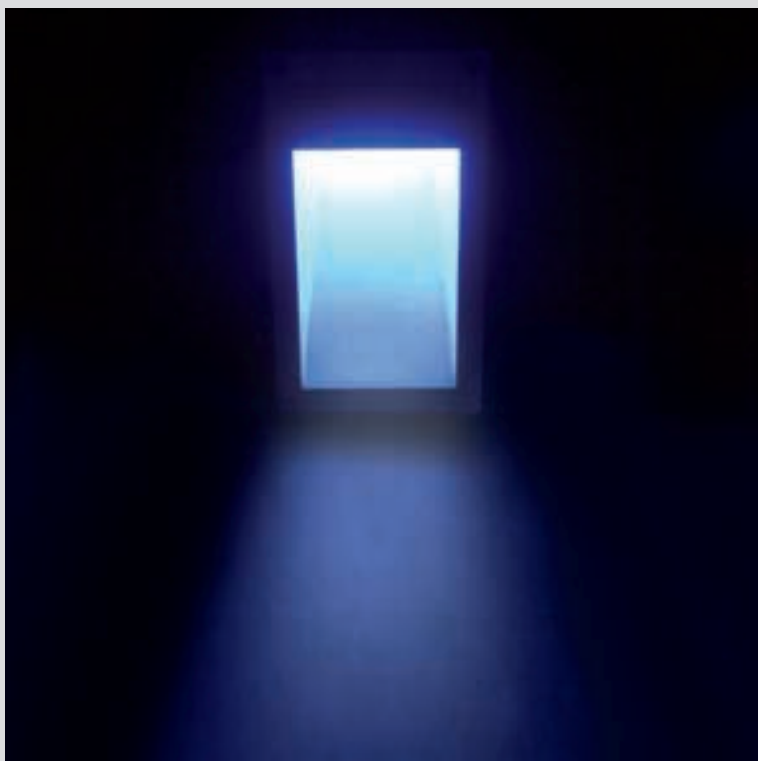



LID

LID STELO



LID

Apparecchio da incasso a parete a luce indiretta costituito da:

- Corpo in alluminio pressofuso verniciato
- Diffusore in vetro temperato
- Parabola riflettente in alluminio
- Guarnizioni in silicone
- Viti di chiusura in acciaio inox
- Controcassa a muro in tecnopolimero
- Verniciatura in polveri poliestere ad elevata resistenza ai raggi ultravioletti e alla corrosione

Indirect light recessed wall luminaire constructed of:

- Painted die-cast aluminium body
- Tempered glass diffuser
- Aluminium reflector
- Silicon gaskets
- Stainless steel screws
- Technopolymer wall holder
- Painting using high resistance to UV and corrosion polyester powders



LID STELO

Piantana per esterni composta da:

- Corpo in alluminio pressofuso verniciato
- Palo in alluminio estruso verniciato
- Diffusore in vetro satinato

Outdoor post luminaire constructed of:

- Painted die-cast aluminium body
- Painted extruded aluminium post
- Satin glass diffuser



Colori - Colours

- X=2 Bianco
White
- X=3 Nero
Black
- X=9 Antracite
Anthracite
- X=4 Silver

Diffusore - Diffuser

Codice-Code 00 3070 - 00 3071
00 3072 - 00 3073

Le lampadine vengono fornite solo su richiesta ad eccezione della versione T2 6W

Bulbs supplied only on request except for T2 6W version

Gli apparecchi vengono forniti completi di cassaforma

The holder is enclosed to the luminaire

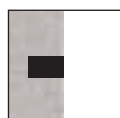

Incasso a parete
Recessed wall version



La cassaforma deve essere installata a filo muro.
Holder must be recessed flush with the wall surface

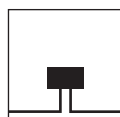

Doppia entrata cavi di alimentazione
Double power supply cables input

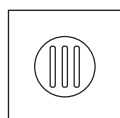

Fluorescente 6W Gx53
Non necessita di alcun alimentatore.
Fluorescent lamp 6W Gx53
Does not need the power supplier

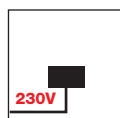

LED - art. 3070.88X - 3071.88X - 3073.88X
art. 3178.88X - 3278.88X - 3176.88X
art. 3276.88X

Led a tensione di rete 220/240V 50Hz.
Connessione diretta alla rete di alimentazione senza necessità di trasformatore.
LED's direct operation at 220/240V 50Hz.
No transformer is required.



LID

IK 07



LID STELO

IK 10



CS 30 per/for cod. 3070 - 3071 - 3072
Cassaforma in tecnopolimero per vano ad incasso h mm 112 - 143x244
Technopolymer holder to be recessed into the wall h mm 112 - 143x244



CS 73 per/for cod. 3073
Cassaforma in tecnopolimero per vano ad incasso h mm 63 - 134x134
Technopolymer holder to be recessed into the wall h mm 63 - 134x134

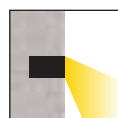

L'emissione di luce verso il basso è nel pieno rispetto delle leggi contro l'inquinamento luminoso.
The direct light emission is in full compliance with standard light pollution directives





3070

3070.96X		TC-D	18W	G24 d-2
3070.95X		TC-D	26W	G24 d-3
3070.88X		2LED bianco/white	8,2W	460 lm 6300 K

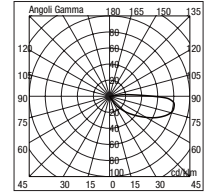
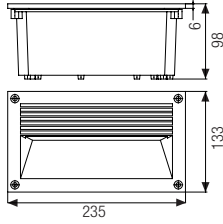

3070 95



3071

3071.76X		QT-DE 12	60W	R7s
• 3071.60X		T2	6W	Gx53
3071.88X		2LED bianco/white	8,2W	460 lm 6000 K

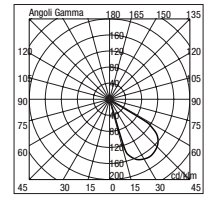
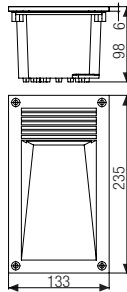

3071 76



3073

3073.14X		QT14 Halopin	40W	G9
3073.88X		1LED bianco/white	4,1W	230 lm 6300 K

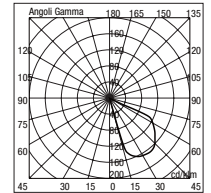
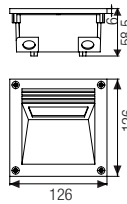

3073 14

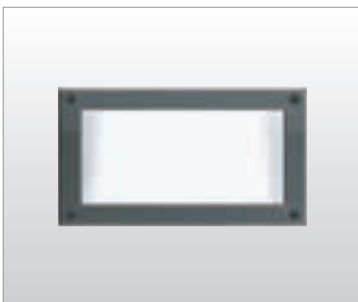

3072

3072.00X		A60	60W	E27
3072.96X		TC-D	18W	G24 d-2
3072.95X		TC-D	26W	G24 d-3

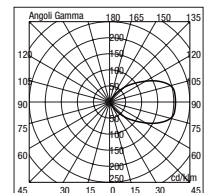
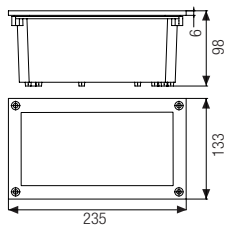

3072 95

- L'apparecchio viene fornito completo di lampadina
Bulb enclosed to the luminaire

LID STELO

LID STELO



3178 - 3278 H 500

1 luce
1 light

3178.14X		QT14 Halopin 1x60W	G9
3178.88X		1LED bianco/white	4,1W 230 lm 6300 K

2 luci
2 light

3278.14X		QT14 Halopin 2x60W	G9
3278.88X		2LED bianco/white	2x4,1W 2x230 lm 6300 K

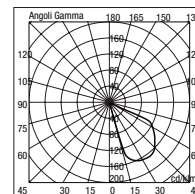
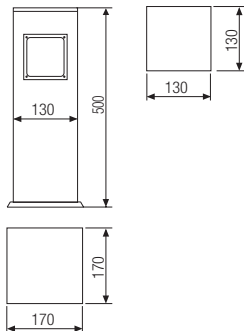

3178 14



3176 - 3276 H 900

1 luce
1 light

3176.76X		QT-DE 12 1x100W	R7s
3176.88X		2LED bianco/white	8,2W 460 lm 6300 K

2 luci
2 light

3276.76X		QT-DE 12 2x60W	R7s
3276.88X		4LED bianco/white	2x8,2W 2x460 lm 6300 K

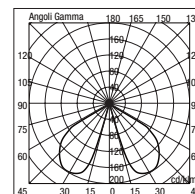
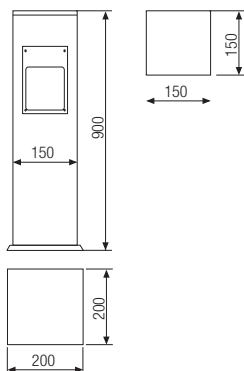

3276 76







DIANA

DIANA

Apparecchio da incasso a parete costituito da:

- Struttura in alluminio pressofuso
- Diffusore in vetro temperato satinato
- Parabola riflettente in alluminio
- Guarnizioni in silicone
- Viti di chiusura in acciaio inox
- Controcassa in tecnopolimero
- Verniciatura in polveri poliestere ad elevata resistenza ai raggi ultravioletti e alla corrosione

Recessed wall luminaire constructed of:

- Die-cast aluminium structure
- Tempered satin glass diffuser
- Aluminium reflector
- Silicon gaskets
- Stainless steel screws
- Technopolymer holder
- Painting using high resistance to UV and corrosion polyester powders



Colori - Colours

X=2  Bianco
White

X=3  Nero
Black

X=9  Antracite
Anthracite

X=4  Silver

Diffusore - Diffuser

Codice-Code 00 4090

Le lampadine vengono fornite solo su richiesta ad eccezione della versione T2 6W-60 LED Gx53

Bulbs supplied only on request except for T2 6W-60 LED Gx53 version

Gli apparecchi a parete vengono forniti completi di cassaforma

The holder is enclosed to the wall luminaires

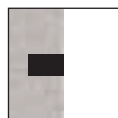

Incasso a parete
Recessed wall version



La cassaforma deve essere installata a filo muro
Holder must be recessed flush with the wall surface

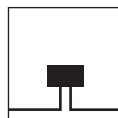

Doppia entrata cavi di alimentazione
Double power supply cables input

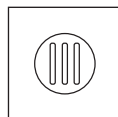

Fluorescente 6W Gx53
Non necessita di alcun alimentatore.
Fluorescent lamp 6W Gx53
Does not need the power supplier

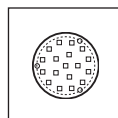

60 LED Gx53
Non necessita di alcun alimentatore.
60 LED Gx53
Does not need the power supplier

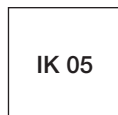

IK 05



CS 49
Controcassa in tecnopolimero da incassare nel muro prima dell'installazione della lampada
h 94 mm - \square 145x145 mm.

Technopolymer holder to be recessed into the wall before the installation of the luminaire h 94 mm - \square 145x145 mm.



4090

- | | | | | | |
|-------------------|--|--------------------|-----|------|---------------|
| 4090.14X | | QT14 | 75W | G9 | |
| • 4090.60X | | T2 | 6W | Gx53 | |
| • 4090.68X | | 60LED bianco/white | 4W | Gx53 | 260 lm 4000 K |

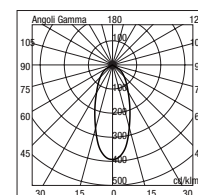
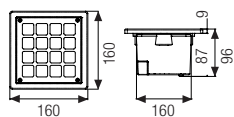

4090 60

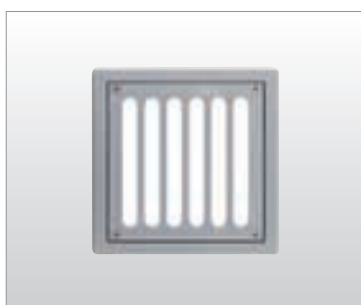

4091

- | | | | | | |
|-------------------|--|--------------------|-----|------|---------------|
| 4091.14X | | QT14 | 75W | G9 | |
| • 4091.60X | | T2 | 6W | Gx53 | |
| • 4091.68X | | 60LED bianco/white | 4W | Gx53 | 260 lm 4000 K |

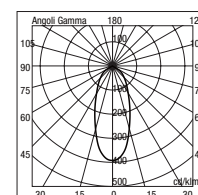
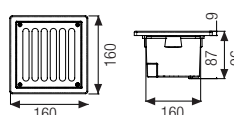

4091 60



4092

- | | | | | | |
|-------------------|--|--------------------|-----|------|---------------|
| 4092.14X | | QT14 | 75W | G9 | |
| • 4092.60X | | T2 | 6W | Gx53 | |
| • 4092.68X | | 60LED bianco/white | 4W | Gx53 | 260 lm 4000 K |

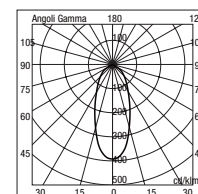
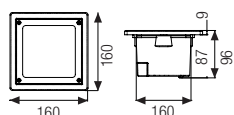

4092 60



4094

- | | | | | | |
|-------------------|--|--------------------|-----|------|---------------|
| 4094.14X | | QT14 | 75W | G9 | |
| • 4094.60X | | T2 | 6W | Gx53 | |
| • 4094.68X | | 60LED bianco/white | 4W | Gx53 | 260 lm 4000 K |

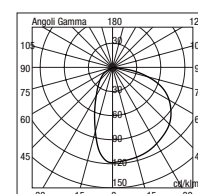
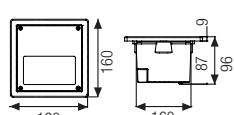

4094 14

- L'apparecchio viene fornito completo di lampadina
Bulb enclosed to the luminaire

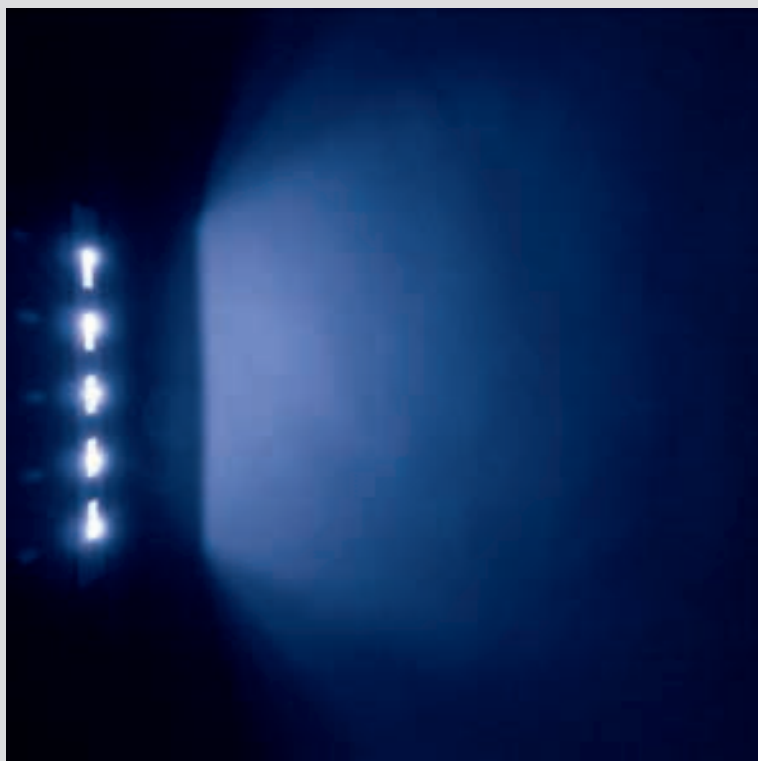



RITZ

RITZ

Apparecchio da incasso a terra o a parete costituito da:

- Corpo in alluminio pressofuso verniciato
- Anello in alluminio pressofuso verniciato o in acciaio inox AISI 316
- Diffusore in vetro temperato satinato
- Parabola riflettente in acciaio inox
- Guarnizioni in silicone
- Viti di chiusura in acciaio inox
- Controcassa a muro in tecnopolimero
- Verniciatura in polveri poliestere ad elevata resistenza ai raggi ultravioletti e alla corrosione

Cod. 1414 - 1415

Installabile anche a pavimento. Il diffusore rimane perfettamente a filo pavimento in modo da non intralciare il camminamento

Recessed ground or wall luminaire constructed of:

- Painted die-cast aluminium body
- Painted die-cast aluminium or stainless steel AISI 360 ring
- Aluminium reflector
- Satin tempered glass diffuser
- Silicon gaskets
- Stainless steel screws
- Technopolymer wall holder
- Painting using high resistance to UV and corrosion polyester powders

Code. 1414 - 1415

The diffuser is flush with the floor perfectly as do not obstacle the walking



IP65 Versione a parete
Wall version

IP67 Versione a terra
Ground version

Colori - Colours Per/for 1414

X=9 Antracite
Anthracte

X=4 Silver

Colori Led - Led colours



Diffusore - Diffuser

Codice-Code 00 1414

Le lampadine vengono fornite solo su richiesta

Bulbs supplied only on request

Gli apparecchi vengono forniti completi di cassaforma

The holder is enclosed to the luminaire

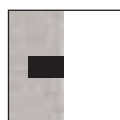

Incasso a parete
Recessed wall version



Cod. 1414 - 1415
Incasso a terra
Recessed ground version



Versione parete. La cassaforma deve essere installata a filo muro.
Holder must be recessed flush with the wall surface

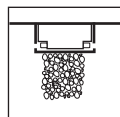

Versione terra. La cassaforma deve essere installata a filo terreno, prevedendo ghiaia di drenaggio per almeno 30 cm.
Ground luminaire. The holder must be recessed into the ground providing a drainage-gravel for at least 30 cm

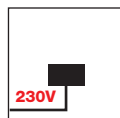

5 LED
L'apparecchio è fornito completo di alimentatore elettronico Full Range 100/240V 50/60Hz posizionato all'interno dell'apparecchio
The luminaire is supplied with a Full Range 100/240V 50/60Hz built-in transformer.

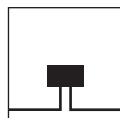

Doppia entrata cavi di alimentazione con pressacavi M16 (Ø 5÷10 mm). Usare cavi flessibili. (Cavi rigidi possono compromettere la tenuta stagna IP 67).
Double power supply entry cable with M16 (Ø 5÷10 mm) cable glands. Use flexible cables (rigid cables may compromise IP 67 rating)



CS 14
Cassaforma in tecnopolimero per vano ad incasso h mm 112 - mm 88x270
Technopolymer holder to be recessed h mm 112 - mm 88x270



IK 08

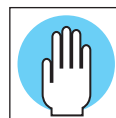

Simbolo che indica la temperatura superficiale sul vetro T<70°C (dati rilevati a ta di 15°C)
Glass surface temperature T<70°C (ambient temperature data of 15°C)

Temperatura calotta (ta 15°C)

Cod. 4014 - 4015

Cover's temperature (ta 15°C)

Code 4014 - 4015

TC-D	18W	65°C	1
5 LED	5,5W	35°C	1

Zona di installazione:

Intended usage:

NOTA: zona di installazione definita dalla norma EN 60598-2-13

Allegato A - Vedi pag. 377

Note: intended usage is defined by the standard EN 60598-2-13 Annex A - See pag. 377



1420

Copertura in acciaio inox - Installabile a parete
Stainless steel cover - Wall mounting

- **1420.660** 5LED bianco/white 6W 675 lm 6000 K
- **1420.670** 5LED blu/blue 6W 370 lm
- **1420.680** 5LED rosso/red 6W 370 lm

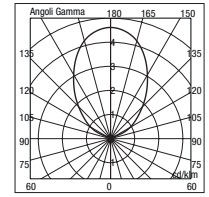
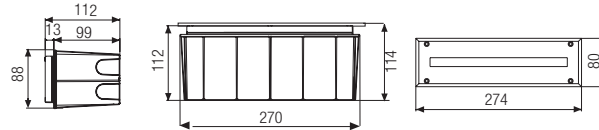

1420 66



1418

Copertura in acciaio inox - Installabile a parete
Stainless steel cover - Wall mounting

- **1418.660** 5LED bianco/white 6W 675 lm 6000 K
- **1418.670** 5LED blu/blue 6W 370 lm
- **1418.680** 5LED rosso/red 6W 370 lm

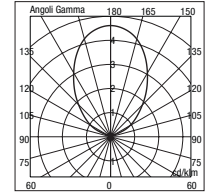
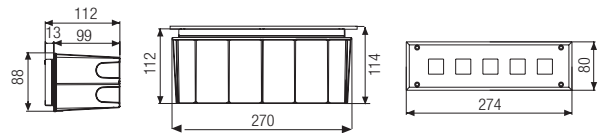

1418 66



1416

Copertura in acciaio inox - Installabile a parete
Stainless steel cover - Wall mounting

- **1416.960** TC-D 18W G24 d-2
- **1416.660** 5LED bianco/white 6W 675 lm 6000 K
- **1416.670** 5LED blu/blue 6W 370 lm
- **1416.680** 5LED rosso/red 6W 370 lm

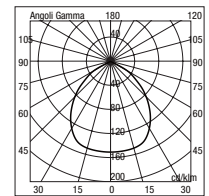
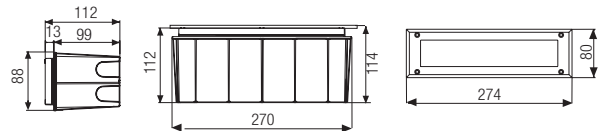

1416 96



1414

Copertura in alluminio pressofuso - Installabile a pavimento o a parete
Die-cast aluminium cover - Floor or wall mounting

- **1414.96X** TC-D 18W G24 d-2
- **1414.66X** 5LED bianco/white 6W 675 lm 6000 K
- **1414.67X** 5LED blu/blue 6W 370 lm
- **1414.68X** 5LED rosso/red 6W 370 lm

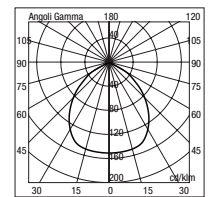
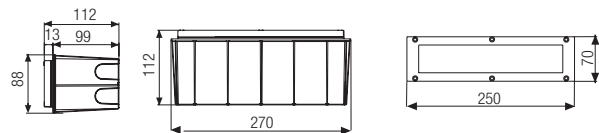

1414 96



1415

Copertura in acciaio inox - Installabile a pavimento o a parete
Stainless steel cover - Floor or wall mounting

- **1415.960** TC-D 18W G24 d-2
- **1415.660** 5LED bianco/white 6W 675 lm 6000 K
- **1415.670** 5LED blu/blue 6W 370 lm
- **1415.680** 5LED rosso/red 6W 370 lm

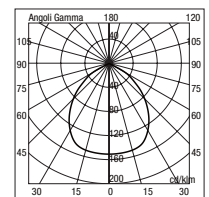
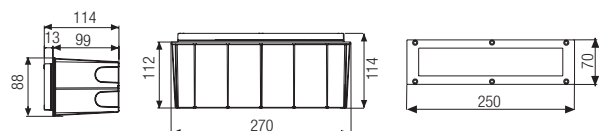

1415 96

- **Con alimentatore elettronico incorporato**
Built-in electronic power supplier





STYLE

STYLE

Apparecchio da incasso a parete per illuminazione di interni ed esterni, disponibile in due dimensioni **BIG** e **MINI** costituito da:

- Corpo in alluminio pressofuso
- Copertura in acciaio inox AISI 316
- Diffusore in vetro opale temperato
- Guarnizioni in silicone
- Cassaforma a muro in tecnopolimero
- Viti di chiusura in acciaio inox
- Verniciatura in polveri poliestere ad elevata resistenza ai raggi ultravioletti e alla corrosione

Indoor and outdoor recessed wall luminaire, available in two sizes **BIG** and **MINI** constructed of:

- Die-cast aluminium structure
- Stainless steel cover AISI 316
- Tempered opal glass diffuser
- Silicon gaskets
- Technopolymer wall holder
- Stainless steel screws
- Painting using high resistance to UV and corrosion polyester powders



Colori Led - Led colours



Diffusore - Diffuser

Codice-Code 00 1015 per-for MINI
Codice-Code 00 8051 per-for BIG

Le lampadine vengono fornite solo su richiesta

Bulbs supplied only on request

Gli apparecchi vengono forniti completi di cassaforma

The holder is enclosed to the luminaire

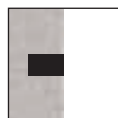

Incasso a parete
Recessed wall version



La cassaforma deve essere installata a filo muro.
Holder must be recessed flush with the wall surface

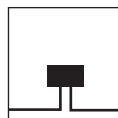

Doppia entrata cavi di alimentazione
Double power supply cables input

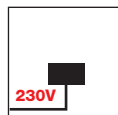

LED - art. 1015.880 - 1016.880 - 1028.880
Led a tensione di rete 220/240V 50Hz.
Connessione diretta alla rete di alimentazione senza necessità di trasformatore.
LED's operation at 220/240V 50Hz voltage directly.
No transformer is required.



CS 99 per/for STYLE MINI
Cassaforma in tecnopolimero per vano ad incasso - mm 230x95x85
Technopolymer holder to be recessed into the wall - mm 230x95x85



CS 54 per/for STYLE BIG
Controcassa in tecnopolimero da incassare nel muro - mm 310x120x100
Technopolymer holder to be recessed into the wall - mm 310x120x100



IK 06





1015 MINI
2015 BIG

STYLE MINI

1015.000		C35	40W	E14
1015.910		TC	9W	G23
1015.880		2LED bianco/white	8,2W	460 lm 6300 K

STYLE BIG

2015.000		A60	60W	E27
2015.960		TC-D	18W	G24 d-2
2015.950		TC-D	26W	G24 d-3

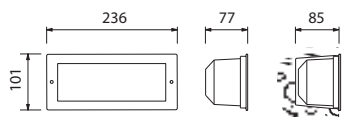

STYLE MINI

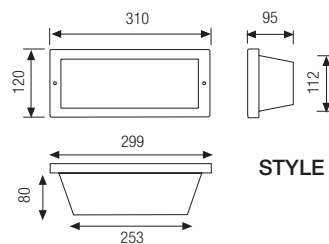

STYLE BIG

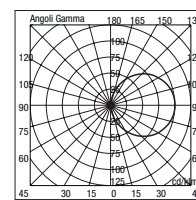

1015 00

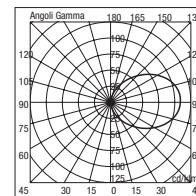

2015 00



1016 MINI
2016 BIG

STYLE MINI

1016.000		C35	40W	E14
1016.910		TC	9W	G23
1016.880		2LED bianco/white	8,2W	460 lm 6300 K

STYLE BIG

2016.000		A60	60W	E27
2016.960		TC-D	18W	G24 d-2
2016.950		TC-D	26W	G24 d-3

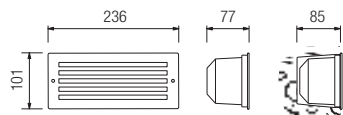

STYLE MINI

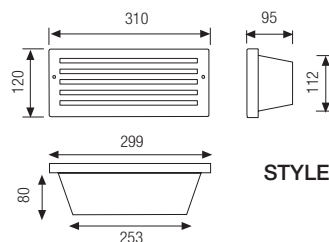

STYLE BIG

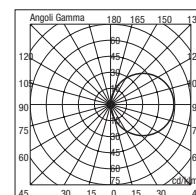

1016 00

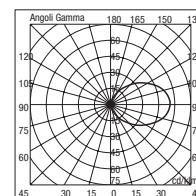

2016 00



1028 MINI

STYLE MINI

1028.000		C35	40W	E14
1028.910		TC	9W	G23
1028.880		2LED bianco/white	8,2W	460 lm 6300 K

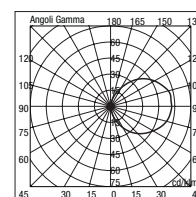
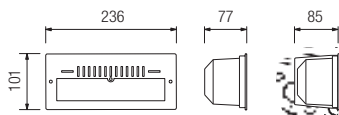

1028 91





IPSE



IPSE

Apparecchio da incasso a parete costituito da:

- Corpo in alluminio pressofuso verniciato
- Diffusore in vetro temperato satinato o policarbonato
- Parabola riflettente in alluminio
- Guarnizioni in EPDM
- Controcassa a muro in tecnopolimero
- Viti di chiusura in acciaio Inox
- Verniciatura in polveri poliestere ad elevata resistenza ai raggi ultravioletti e alla corrosione

Recessed wall luminaire constructed of:

- Die-cast painted aluminium body
- Satin tempered glass or polycarbonate diffuser
- Aluminium reflector
- EPDM gaskets
- Technopolymer wall holder
- Stainless steel screws
- Painting using high resistance to UV and corrosion polyester powders



Colori - Colours

X=2  Bianco
White

X=3  Nero
Black

X=9  Antracite
Anthracite

X=4  Silver

Diffusore - Diffuser

Codice-Code 00 8051

per/for Cod. 8051 - 8053 - 8055

Codice-Code 00 1034

per/for Cod. 8050 - 8052 - 8054

Codice-Code 00 4815

per/for Cod. 4815

Codice-Code 00 4811

per/for Cod. 4811

Codice-Code 08 3090

per/for Cod. 3090 - 3091

Le lampadine vengono fornite solo su richiesta

Bulbs supplied only on request

Gli apparecchi vengono forniti completi di cassaforma

The holder is enclosed to the luminaire

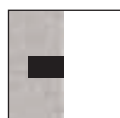

Incasso a parete
Recessed wall version



La cassaforma deve essere installata a filo muro.
Holder must be recessed flush with the wall surface

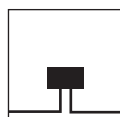

Doppia entrata cavi di alimentazione
Double power supply cables input



CS 19 (per/for Cod. 4811-8050 - 8052 - 8054)
Controcassa in tecnopolimero da incassare nel muro mm 275x140x80
Technopolymer holder to be recessed into the wall mm 275x140x80



CS 93 (per/for Cod. 4815 - 3090 - 3091)
Controcassa in tecnopolimero da incassare nel muro prima dell'installazione della lampada Ø mm 260 - h mm 60
Technopolymer holder to be recessed into the wall before the installation of the luminaire Ø mm 260 - h mm 60



CS 53 (per/for Cod. 8051 - 8053 - 8055)
Controcassa in tecnopolimero da incassare nel muro - mm 290x105x90
Technopolymer holder to be recessed into the wall - mm 290x105x90



3090 - 3091

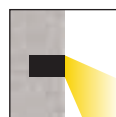

Per/for Cod. 4811 - 4815
L'emissione di luce verso il basso è nel pieno rispetto delle leggi contro l'inquinamento luminoso.
The direct light emission is in full compliance with standard light pollution directives

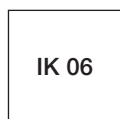

IK 06



IK 07

per/for Cod. 4811 - 4815



4815

A luce indiretta
Indirect light

4815.96X  TC-D 18W G24 d-2

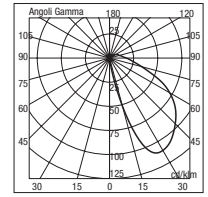
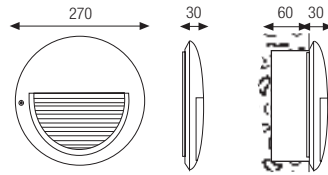

4815 96



4811

A luce indiretta
Indirect light

4811.96X  TC-D 18W G24 d-2

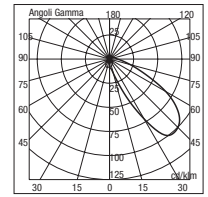
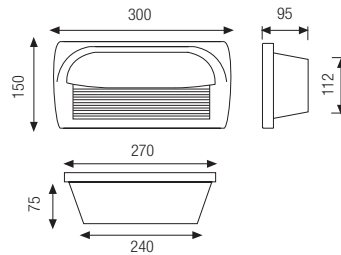

4811 96



3090

Disponibile solo con diffusore in policarbonato
Available only with polycarbonate diffuser

3090.96X  TC-D 18W G24 d-2

3090.95X  TC-D 26W G24 d-3

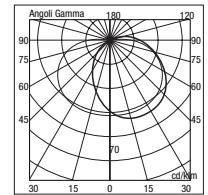
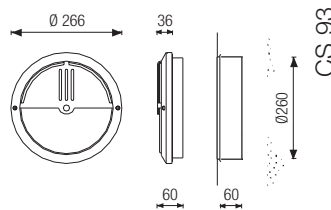

3090 95



3091

Disponibile solo con diffusore in policarbonato
Available only with polycarbonate diffuser

3091.96X  TC-D 18W G24 d-2

3091.95X  TC-D 26W G24 d-3

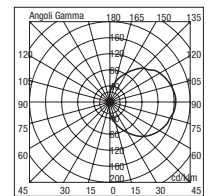
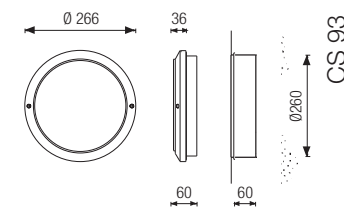

3091 95

IPSE



8053

8053.00X		A60	60W	E27
8053.96X		TC-D	18W	G24 d-2
8053.95X		TC-D	26W	G24 d-3

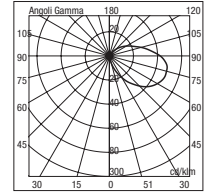
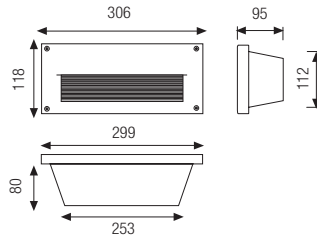

8053 96



8051

8051.00X		A60	60W	E27
8051.96X		TC-D	18W	G24 d-2
8051.95X		TC-D	26W	G24 d-3

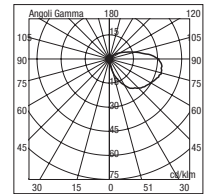
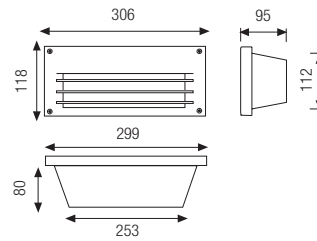

8051 95



8055

8055.00X		A60	60W	E27
8055.96X		TC-D	18W	G24 d-2
8055.95X		TC-D	26W	G24 d-3

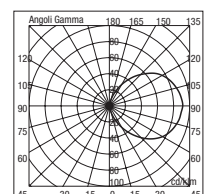
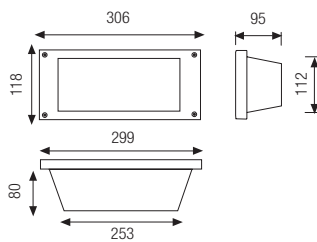

8055 95



8052

8052.00X		A60	60W	E27
8052.96X		TC-D	18W	G24 d-2
8052.95X		TC-D	26W	G24 d-3

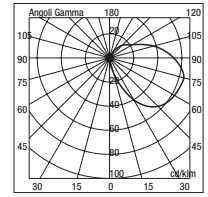
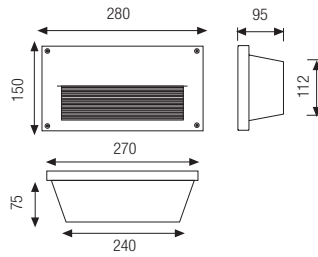

8052 96



8050

8050.00X		A60	60W	E27
8050.96X		TC-D	18W	G24 d-2
8050.95X		TC-D	26W	G24 d-3

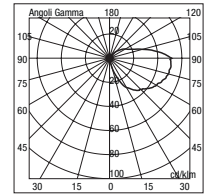
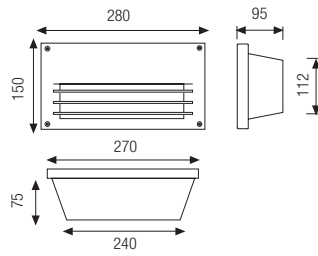

8050 95



8054

8054.00X		A60	60W	E27
8054.96X		TC-D	18W	G24 d-2
8054.95X		TC-D	26W	G24 d-3

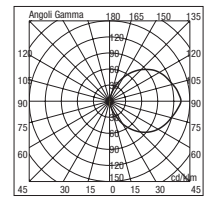
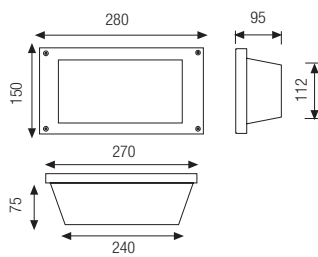

8054 00

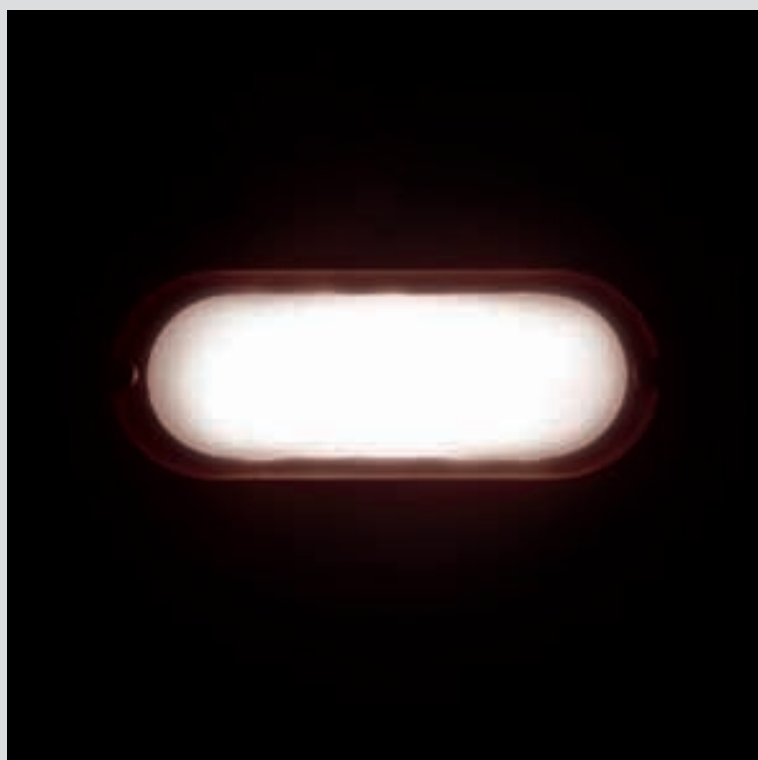



FLASH

GAMMA



FLASH

Apparecchio da incasso a parete disponibile in due dimensioni BIG e MINI costituito da:

- Corpo in alluminio pressofuso
- Diffusore in vetro temperato satinato
- Guarnizione in silicone per Flash Mini e in EPDM per Flash Big
- Controcassa a muro in tecnopolimero
- Viti di chiusura in acciaio inox
- Verniciatura in polveri poliestere ad elevata resistenza ai raggi ultravioletti e alla corrosione

Recessed wall luminaire, available in two sizes BIG and MINI constructed of:

- Die-cast aluminium structure
- Satin tempered glass diffuser
- Silicon gasket for Flash Mini and EPDM gasket
- Technopolymer wall holder
- Stainless steel screws
- Painting using high resistance to UV and corrosion polyester powders

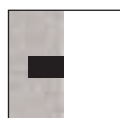

Incasso a parete
Recessed wall version



La cassaforma deve essere installata a filo muro.
Holder must be recessed flush with the wall surface

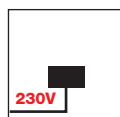

LED - art. 1035.88X - 1037.88X - 1039.88X
Led a tensione di rete 220/240V 50Hz.
Connessione diretta alla rete di alimentazione senza necessità di trasformatore.
LED's direct operation at 220/240V 50Hz.
No transformer is required.

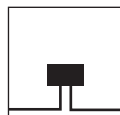

Doppia entrata cavi di alimentazione
Power supply cables input



CS 99 per/for MINI
Cassaforma in tecnopolimero per vano ad incasso - mm 230x95x85
Technopolymer holder to be recessed into the wall - mm 230x95x85



CS 19 per/for BIG
Controcassa in tecnopolimero da incassare nel muro mm 275x140x80
Technopolymer holder to be recessed into the wall mm 275x140x80

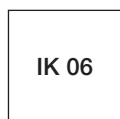

IK 06



Colori - Colours

X=2 Bianco
White

X=3 Nero
Black

X=9 Antracite
Anthracite

X=4 Silver

Diffusore - Diffuser

Codice-Code 00 1034
per/for BIG

Codice-Code 00 1037
per/for MINI

Le lampadine vengono fornite solo su richiesta

Bulbs supplied only on request

Gli apparecchi vengono forniti completi di cassaforma

The holder is enclosed to the luminaire





1037 MINI
1034 BIG

FLASH MINI

1037.00X		C35	40W	E14
1037.91X		TC	9W	G23
1037.88X		2LED bianco/white	8,2W	460 lm 6300 K

FLASH BIG

1034.00X		A60	60W	E27
1034.96X		TC-D	18W	G24 d-2
1034.95X		TC-D	26W	G24 d-3

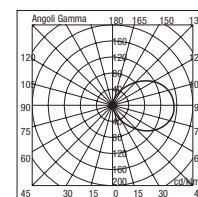

1037 00

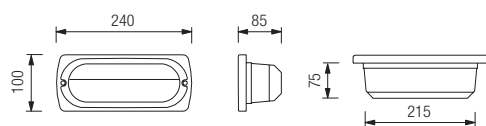

FLASH MINI

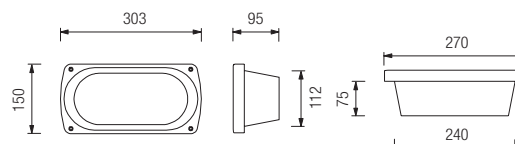

FLASH BIG



1039 MINI
1036 BIG

FLASH MINI

1039.00X		C35	40W	
1039.91X		TC	9W	
1039.88X		2LED bianco/white	8,2W	460 lm 6300 K

FLASH BIG

1036.00X		A60	60W	E27
1036.96X		TC-D	18W	G24 d-2
1036.95X		TC-D	26W	G24 d-3

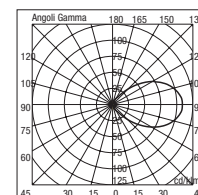

1036 00

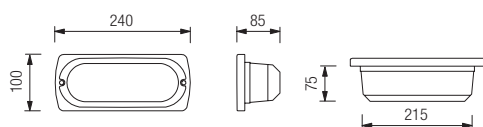

FLASH MINI

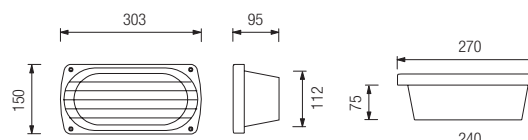

FLASH BIG



1035 MINI
1038 BIG

FLASH MINI

1035.00X		C35	40W	
1035.91X		TC	9W	
1035.88X		2LED bianco/white	8,2W	460 lm 6300 K

FLASH BIG

1038.00X		A60	60W	E27
1038.96X		TC-D	18W	G24 d-2
1038.95X		TC-D	26W	G24 d-3

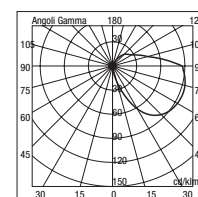

1038 95

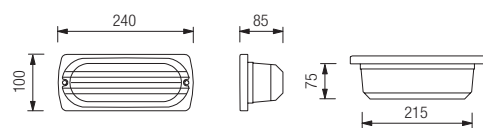

FLASH MINI

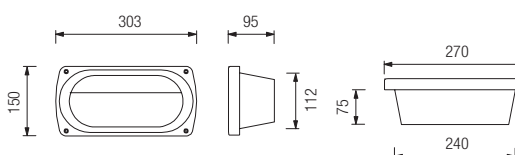

FLASH BIG

GAMMA

Apparecchio da incasso a parete costituito da:

- Corpo e anello in alluminio pressofuso
- Diffusore in vetro temperato satinato
- Guarnizione in EPDM per Gamma Big e in silicone per Gamma Mini
- Controcassa a muro in tecnopolimero
- Viti di chiusura in acciaio inox
- Verniciatura in polveri poliestere ad elevata resistenza ai raggi ultravioletti e alla corrosione

Recessed wall luminaire constructed of:

- Die-cast aluminium body and ring
- Satin tempered glass diffuser
- EPDM gasket for Gamma Big and silicon gasket for Gamma Mini
- Technopolymer wall holder
- Stainless steel screws
- Painting using high resistance to UV and corrosion polyester powders



Colori - Colours

X=2 Bianco White

X=3 Nero Black

X=9 Antracite Anthracite

X=4 Silver

per-for **GAMMA OVAL**

X=2 Bianco White

X=3 Nero Black

Diffusore - Diffuser

Codice-Code 00 1090
per/for **BIG**

Codice-Code 00 1093
per/for **MINI**

Codice-Code 00 1095
per/for **OVAL**

Le lampadine vengono fornite solo su richiesta
Bulbs supplied only on request

Gli apparecchi vengono forniti completi di cassaforma
The holder is enclosed to the luminaire

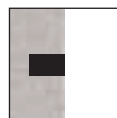

Incasso a parete
Recessed wall version



La cassaforma deve essere installata a filo muro.
holder must be recessed flush with the wall surface

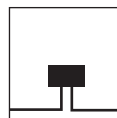

Doppia entrata cavi di alimentazione
Power supply cables input

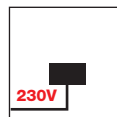

LED - art. 1011.88X - 1093.88X - 1094.88X art. 1099.88X

Led a tensione di rete 220/240V 50Hz.
Connessione diretta alla rete di alimentazione senza necessità di trasformatore.
LED's direct operation at 220/240V 50Hz.
No transformer is required.



CS 99 per/for MINI
Cassaforma in tecnopolimero per vano ad incasso - mm 230x95x85
Technopolymer holder to be recessed into the wall - mm 230x95x85



CS 19 per/for BIG
Controcassa in tecnopolimero da incassare nel muro mm 275x140x80
Technopolymer holder to be recessed into the wall mm 275x140x80

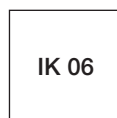

IK 06



Per/for Cod. 1092 - 1094

L'emissione di luce verso il basso è nel pieno rispetto delle leggi contro l'inquinamento luminoso.

The direct light emission is in full compliance with standard light pollution directives



1010

1010.00X		A60	60W	E27
1010.96X		TC-D	18W	G24 d-2
1010.95X		TC-D	26W	G24 d-3

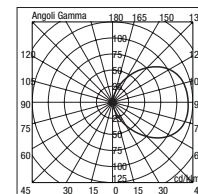
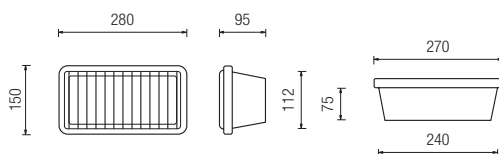

1010 00



1090

1090.00X		A60	60W	E27
1090.96X		TC-D	18W	G24 d-2
1090.95X		TC-D	26W	G24 d-3

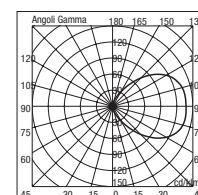
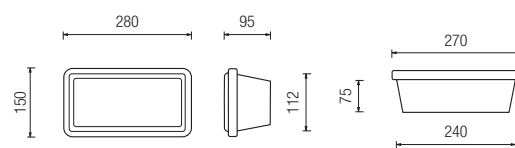

1090 00

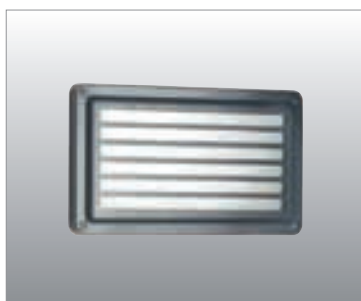

1091

1091.00X		A60	60W	E27
1091.96X		TC-D	18W	G24 d-2
1091.95X		TC-D	26W	G24 d-3

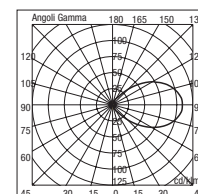
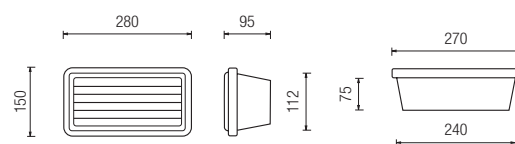

1091 00

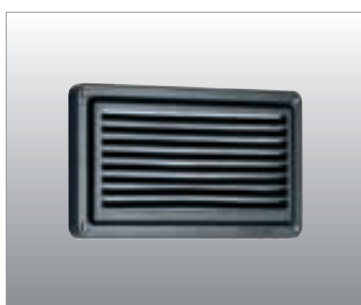

1092

1092.00X		A60	60W	E27
1092.96X		TC-D	18W	G24 d-2
1092.95X		TC-D	26W	G24 d-3

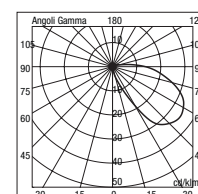
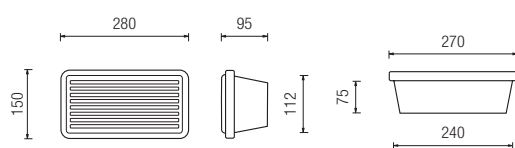



1092 95

GAMMA MINI

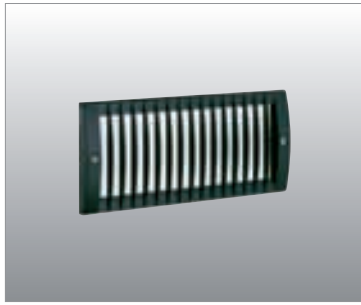
GAMMA MINI



1011

1011.00X		C35	40W	E14
1011.91X		TC	9W	G23
1011.88X		2LED bianco/white	8,2W	460 lm 6300 K

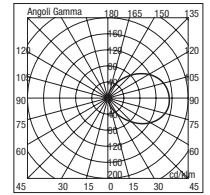
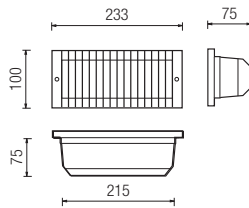

1011 00



1099

1099.00X		C35	40W	E14
1099.91X		TC	9W	G23
1099.88X		2LED bianco/white	8,2W	460 lm 6300 K

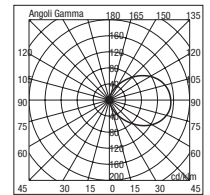
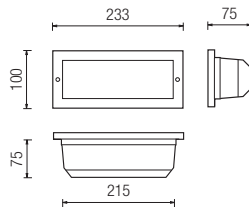

1099 00

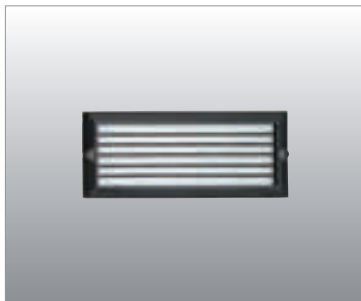

1093

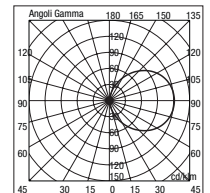
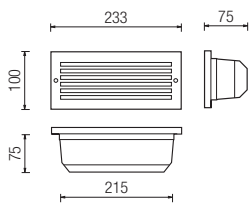

1093.00X		C35	40W	E14
1093.91X		TC	9W	G23
1093.88X		2LED bianco/white	8,2W	460 lm 6300 K

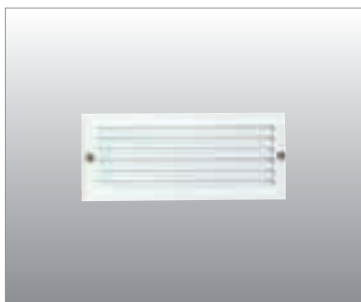

1093 00



1094

1094.00X		C35	40W	E14
1094.91X		TC	9W	G23
1094.88X		2LED bianco/white	8,2W	460 lm 6300 K

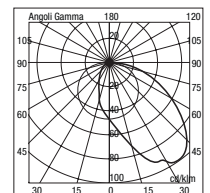
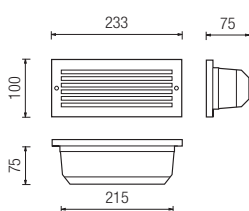

1094 91

GAMMA OVAL

GAMMA OVAL



1095

1095.00X  A60 60W E27

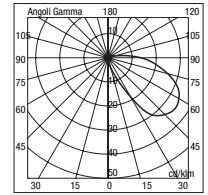
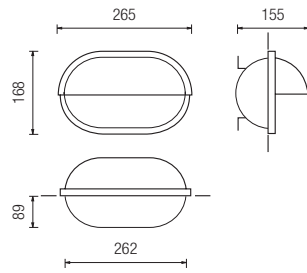

1095 00



1096

1096.00X  A60 60W E27

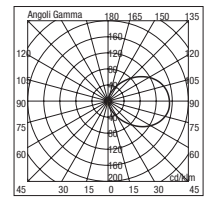
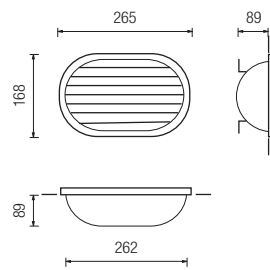

1096 00



1097

1097.00X  A60 60W E27

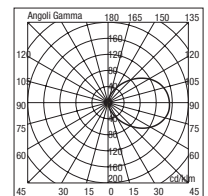
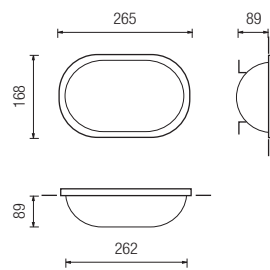

1097 00



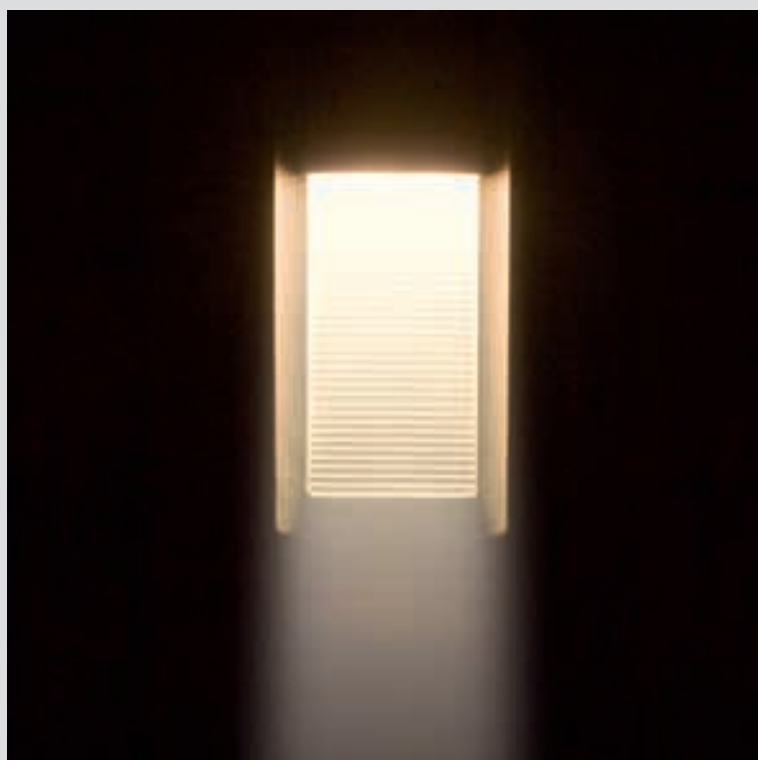



CLIC



CLIC

Apparecchio da incasso a parete per illuminazione di interni ed esterni costituito da:

- Struttura in alluminio pressofuso verniciato
- Diffusore in vetro temperato
- Parabola riflettente in alluminio
- Guarnizione in silicone
- Viti di chiusura in acciaio inox
- Cassaforma in tecnopolimero
- Verniciatura in polveri poliestere ad elevata resistenza ai raggi ultravioletti e alla corrosione

Indoor and outdoor recessed wall luminaire constructed of:



- Painted die-cast aluminium structure
- Tempered glass diffuser
- Aluminium reflector
- Silicon gasket
- Stainless steel screws
- Technopolymer wall holder
- Painting using high resistance to UV and corrosion polyester powders



CL I QT14 / 1LED

CL III QT9 / 12V

Colori - Colours

- X=3  Nero
Black
- X=9  Antracite
Anthracite
- X=4  Silver

Diffusore - Diffuser

Codice-Code 00 4019

per/for Cod. 4019

Codice-Code 00 4018

per/for Cod. 4018

Codice-Code 00 4010

per/for Cod. 4012/4015

Codice-Code 00 4011

per/for Cod. 4011/4014

Le lampadine vengono fornite solo su richiesta

Bulbs supplied only on request

Gli apparecchi vengono forniti completi di cassaforma

The holder is enclosed to the luminaire

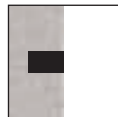

Incasso a parete
Recessed wall version

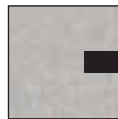

La cassaforma deve essere installata a filo muro.
Holder must be recessed flush with the wall surface

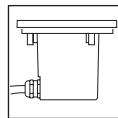

4011 - 4012 - 4014 - 4015 - 4018
Entrata singola cavi di alimentazione con pressacavi M16 (Ø 5÷10 mm).

Usare cavi flessibili. (Cavi rigidi possono compromettere la tenuta stagna IP67).
Single power supply entry cable with M16 cable glands. Use flexible cables (rigid cables may compromise IP 67 rating)

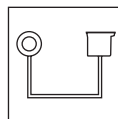

Per/for QT9 /12V
L'apparecchio necessita di trasformatore remoto 230V/12V posizionato all'inizio della linea di alimentazione.

The feeding transformer (230V-12V) for low voltage must be installed in the remote position

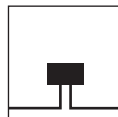

4019
Doppia entrata cavi di alimentazione
Power supply cables input

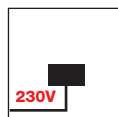

LED - art. 4011.88X - 4012.88X - 4014.88X
art. 4015.88X - 4018.88X - 4019.88X
Led a tensione di rete 220/240V 50Hz.
Connessione diretta alla rete di alimentazione senza necessità di trasformatore.
LED's direct operation at 220/240V 50Hz.
No transformer is required.



CS 4010
Per/for Cod. 4011 - 4012 - 4014 - 4015 - 4018

Cassaforma in tecnopolimero per vano ad incasso Ø mm 110 - h mm 97

Technopolymer holder to be recessed into the wall Ø mm 110 h mm 97



CS 99
Per/for Cod. 4019

Cassaforma in tecnopolimero per vano ad incasso mm 230x95x85

Technopolymer holder to be recessed into the wall mm 230x95x85



4011 - 4014

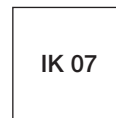

4018 - 4019



4012 - 4015



4018 - 4019
L'emissione di luce verso il basso è nel pieno rispetto delle leggi contro l'inquinamento luminoso.

The direct light emission is in full compliance with standard light pollution directives



4019

4019.14X	QT14 Halopin	40W	G9
4019.88X	1LED bianco/white	4,1W	230 lm 6300 K

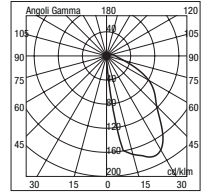
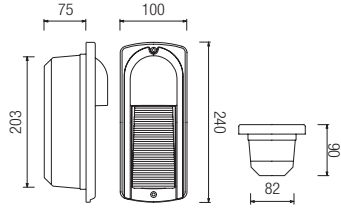

4019 14



4018

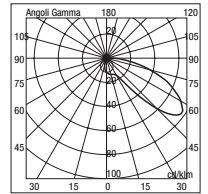
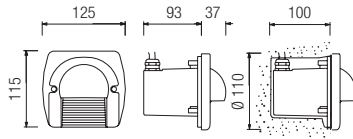

4018.14X	QT14 Halopin	25W	G9
4018.88X	1LED bianco/white	4,1W	230 lm 6300 K



4018 14



4011

4011.09X  QT9 20W G4 12V
 Con trasformatore remoto (non fornito) / Remote transformer (not supplied)
4011.14X  QT14 Halopin 25W G9
4011.88X 1LED bianco/white 4,1W 230 lm 6300 K

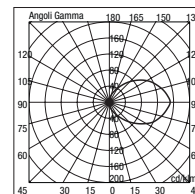
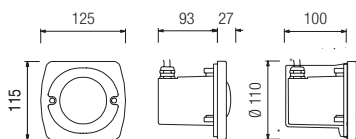

4011 14

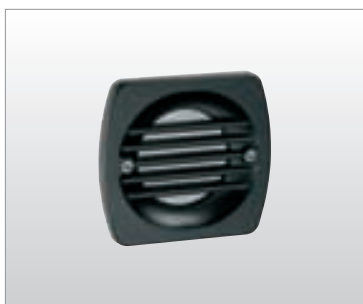

4012

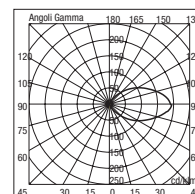
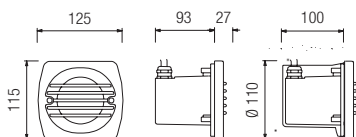

4012.09X  QT9 20W G4 12V
 Con trasformatore remoto (non fornito) / Remote transformer (not supplied)
4012.14X  QT14 Halopin 25W G9
4012.88X 1LED bianco/white 4,1W 230 lm 6300 K



4012 14



4014

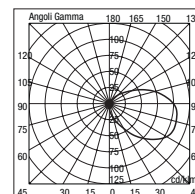
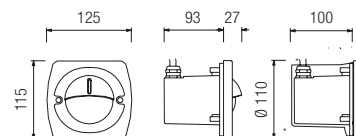

4014.09X  QT9 20W G4 12V
 Con trasformatore remoto (non fornito) / Remote transformer (not supplied)
4014.14X  QT14 Halopin 25W G9
4014.88X 1LED bianco/white 4,1W 230 lm 6300 K



4014 14



4015

4015.09X  QT9 20W G4 12V
 Con trasformatore remoto (non fornito) / Remote transformer (not supplied)
4015.14X  QT14 Halopin 25W G9
4015.88X 1LED bianco/white 4,1W 230 lm 6300 K

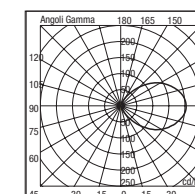
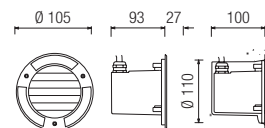

4015 14



CLIC INOX

Apparecchio da incasso a parete, per illuminazione di interni ed esterni costituito da:

- Struttura in alluminio pressofuso verniciato
- Anello o griglia frontale in acciaio inox AISI 316 o in ottone dorato
- Diffusore in vetro satinato temperato
- Parabola riflettente in alluminio
- Guarnizioni in silicone
- Cassaforma in tecnopolimero
- Viti di chiusura in acciaio inox
- Verniciatura in polveri poliestere ad elevata resistenza ai raggi ultravioletti e alla corrosione

Indoor and outdoor recessed wall luminaire constructed of:

- Painted die-cast aluminium structure
- Stainless steel AISI 316 or gold-plated brass cover
- Satin tempered glass diffuser
- Aluminium reflector
- Silicon gaskets
- Technopolymer holder
- Stainless steel screws
- Painting using high resistance to UV and corrosion polyester powders



CL I QT14 / T2 / 1 LED

CL III QT9 12V

Diffusore - Diffuser

Codice-Code 00 6010

(per/for Clic mini)

Codice-Code 00 2166

(per/for Clic big)

Le lampadine vengono fornite solo su richiesta ad eccezione della versione T2 6W

Bulbs supplied only on request except for T2 6W version

Gli apparecchi vengono forniti completi di cassaforma

The holder is enclosed to the luminaire

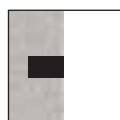

Incasso a parete
Recessed wall version

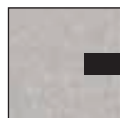

La cassaforma deve essere installata a filo muro.
Holder must be recessed flush with the wall surface

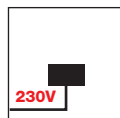

1 LED
Led a tensione di rete 220/240V 50Hz.
Connessione diretta alla rete di alimentazione senza necessità di trasformatore.
LED's direct operation at 220/240V 50Hz.
No transformer is required.

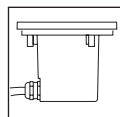

CLIC MINI
Entrata singola cavi di alimentazione con pressacavi M16 (Ø 5÷10 mm).
Usare cavi flessibili. (Cavi rigidi possono compromettere la tenuta stagna IP67).
Single power supply entry cable with M16 cable glands. Use flexible cables (rigid cables may compromise IP 67 rating)

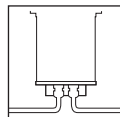

CLIC BIG
Doppia entrata cavi di alimentazione con pressacavi PG13,5 (Ø 6÷12 mm). Usare cavi flessibili per non compromettere la tenuta stagna IP67.
Double entrance of the supply cables with gland type PG 13,5 (Ø 6÷12 mm). Use only flexible cables to grant protection against water exposure (IP 67)

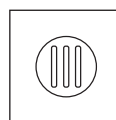

Fluorescente 6W Gx53
Non necessita di alcun alimentatore.
Fluorescent lamp 6W Gx53
Does not need the power supplier

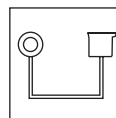

QT9 12V
L'apparecchio va utilizzato con trasformatore remoto 230V/12V posizionato all'inizio della linea di alimentazione.
The feeding transformer (230V-12V) for low voltage must be installed in the remote position



IK 09



CS 5087 per/for CLIC INOX MINI
(per/for 6W Gx53)
Cassaforma in tecnopolimero per vano ad incasso Ø 130 mm - h 100 mm.
Technopolymer holder to be recessed into the wall Ø 130 mm - h 100 mm



CS 1085
(per/for CLIC INOX BIG)
Controcassa in tecnopolimero da incassare nel muro prima dell'installazione della lampada Ø 185 mm - h. 130 mm. Non può essere installata a pavimento.
Technopolymer holder to be fitted into the wall before the installation of the luminaire Ø 185 mm - h 130 mm. Not to be fitted as a buried uplighter.



CS 4010
per/for CLIC INOX MINI - CLIC MINI GOLD
(per/for QT9 / QT14 / 1 LED)
Cassaforma in tecnopolimero per vano ad incasso Ø 110 mm - h 97 mm.
Technopolymer holder to be recessed into the wall Ø 110 mm - h 97 mm.

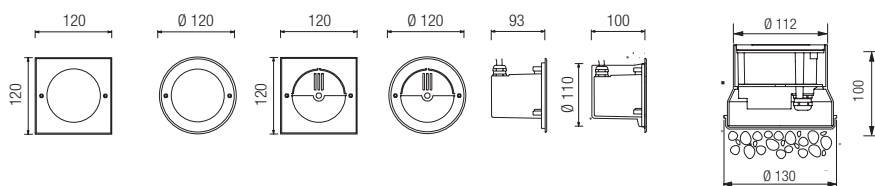

QT9 / QT14 / 1 LED
(CS 4010)

T2 6W Gx53
(CS 5087)



6012

6012.090 QT9 20W G4 12V
Con trasformatore remoto (non fornito) / Remote transformer (not supplied)

6012.140 QT14 Halopin 25W G9

• **6012.600** T2 6W Gx53

6012.880 1LED bianco/white 4,1W 230 lm 6300 K

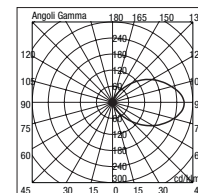

6012 14



6014

6014.090 QT9 20W G4 12V
Con trasformatore remoto (non fornito) / Remote transformer (not supplied)

6014.140 QT14 Halopin 25W G9

• **6014.600** T2 6W Gx53

6014.880 1LED bianco/white 4,1W 230 lm 6300 K

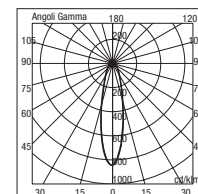

6014 60

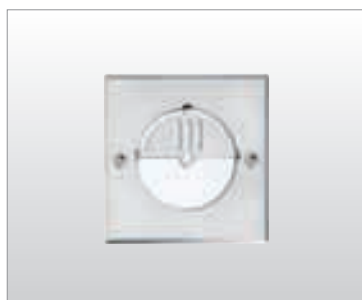

6011

6011.090 QT9 20W G4 12V
Con trasformatore remoto (non fornito) / Remote transformer (not supplied)

6011.140 QT14 Halopin 25W G9

• **6011.600** T2 6W Gx53

6011.880 1LED bianco/white 4,1W 230 lm 6300 K

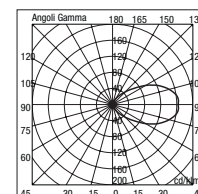

6011 14

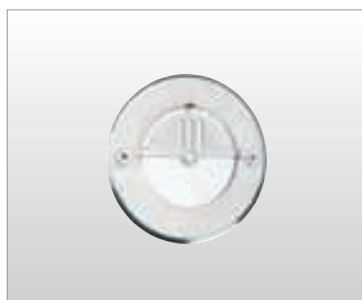

6010

6010.090 QT9 20W G4 12V
Con trasformatore remoto (non fornito) / Remote transformer (not supplied)

6010.140 QT14 Halopin 25W G9

• **6010.600** T2 6W Gx53

6010.880 1LED bianco/white 4,1W 230 lm 6300 K

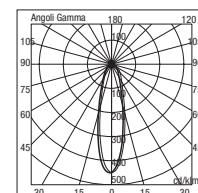

6010 60

- L'apparecchio viene fornito completo di lampadina
Bulb enclosed to the luminaire

CLIC MINI GOLD

CLIC MINI GOLD

Apparecchio per interni
Indoor luminaire

Griglia frontale in ottone dorato
gold-plated brass cover

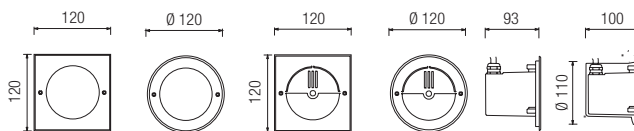

6812

6812.090 QT9 20W G4 12V
Con trasformatore remoto (non fornito) / Remote transformer (not supplied)

6812.140 QT14 Halopin 25W G9

• 6812.600 T2 6W Gx53

6812.880 1LED bianco/white 4,1W 230 lm 6300 K

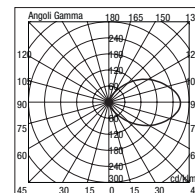

6812 14

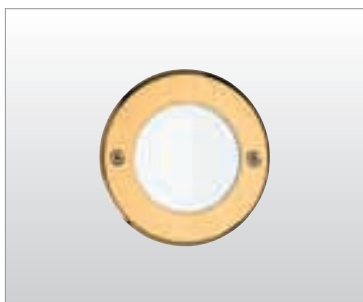

6814

6814.090 QT9 20W G4 12V
Con trasformatore remoto (non fornito) / Remote transformer (not supplied)

6814.140 QT14 Halopin 25W G9

• 6814.600 T2 6W Gx53

6814.880 1LED bianco/white 4,1W 230 lm 6300 K

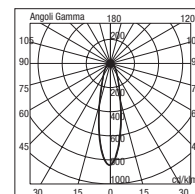

6814 60

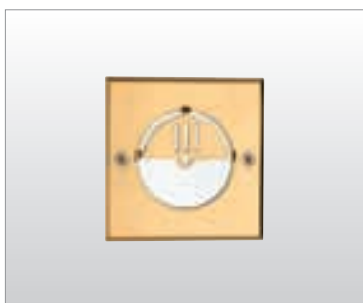

6811

6811.090 QT9 20W G4 12V
Con trasformatore remoto (non fornito) / Remote transformer (not supplied)

6811.140 QT14 Halopin 25W G9

• 6811.600 T2 6W Gx53

6811.880 1LED bianco/white 4,1W 230 lm 6300 K

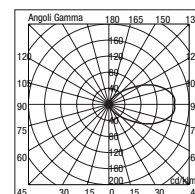

6811 14

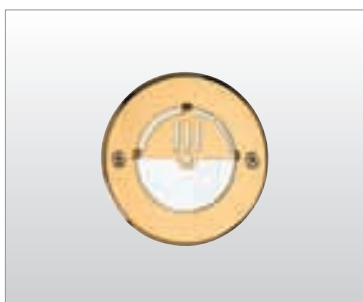

6810

6810.090 QT9 20W G4 12V
Con trasformatore remoto (non fornito) / Remote transformer (not supplied)

6810.140 QT14 Halopin 25W G9

• 6810.600 T2 6W Gx53

6810.880 1LED bianco/white 4,1W 230 lm 6300 K

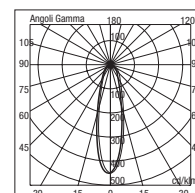

6810 60

- L'apparecchio viene fornito completo di lampadina
Bulb enclosed to the luminaire

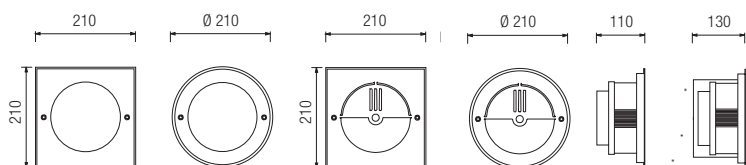

6015

6015.000		C35	40W	E14
6015.920		TC-D	10W	G24 d-1
6015.880		1LED bianco/white	4,1W	230 lm 6300 K

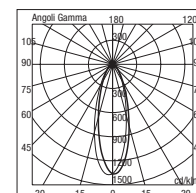

6015 00



6019

6019.000		C35	40W	E14
6019.920		TC-D	10W	G24 d-1
6019.880		1LED bianco/white	4,1W	230 lm 6300 K

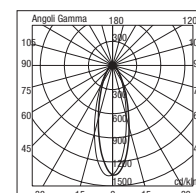

6019 00

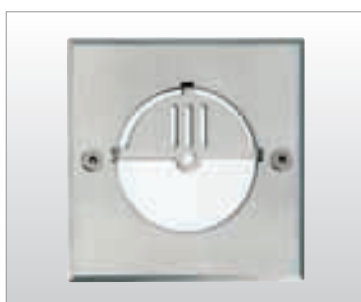

6016

6016.000		C35	40W	E14
6016.920		TC-D	10W	G24 d-1
6016.880		1LED bianco/white	4,1W	230 lm 6300 K

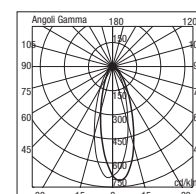

6016 00

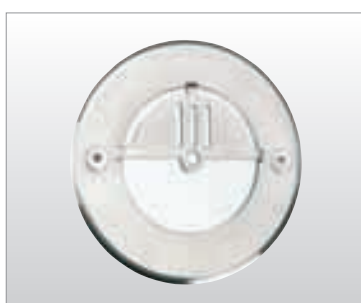

6018

6018.000		C35	40W	E14
6018.920		TC-D	10W	G24 d-1
6018.880		1LED bianco/white	4,1W	230 lm 6300 K

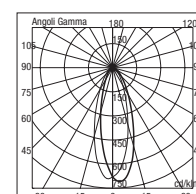

6018 00



CS 1085

Controcassa in tecnopolimero da incassare nel muro prima dell'installazione della lampada Ø 185 mm - h. 130 mm. Non può essere installata a pavimento.
Technopolymer holder to be recessed into the wall before the installation of the luminaire Ø 185 mm - h. 130 mm. Not to be fitted as a buried uplighter

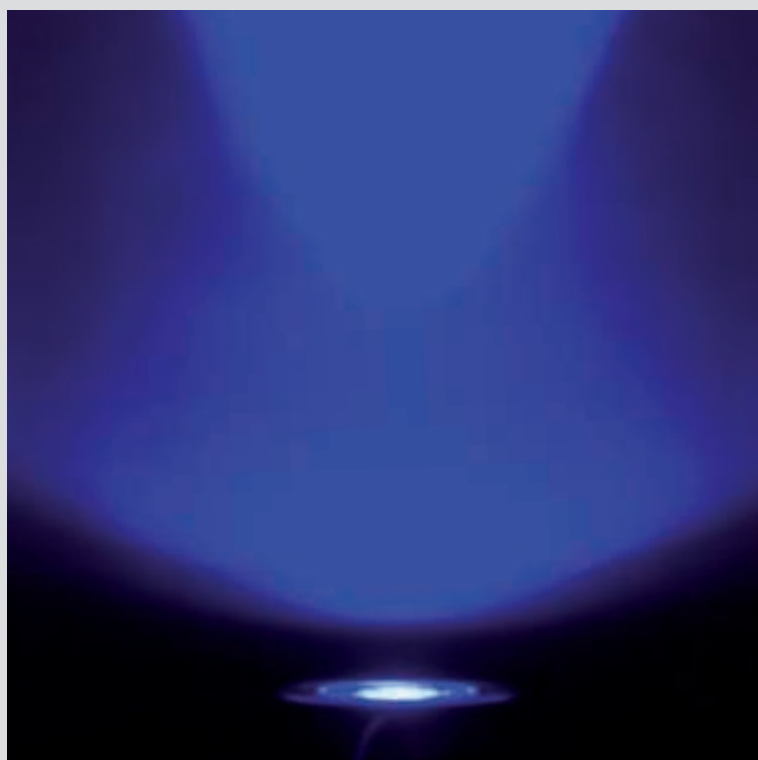



GEO



MICRO GEO

Apparecchio da incasso a terra e a parete per esterni ed interni costituito da:

- Corpo in alluminio pressofuso verniciato
- Anello frontale in acciaio inox AISI 316
- Diffusore in vetro satinato temperato
- Guarnizione in silicone
- Viti di chiusura in acciaio inox
- Controcassa in tecnopolimero
- Verniciatura in polveri poliestere ad elevata resistenza ai raggi ultravioletti e alla corrosione

Outdoor and indoor recessed ground and wall luminaire constructed of:

- Painted die-cast aluminium body
- Stainless steel AISI 316 ring
- Satin tempered glass diffuser
- Silicon gasket
- Stainless steel screws
- Technopolymer holder
- Painting using high resistance to UV and corrosion polyester powders



Colori 1 Led - 1 Led Colours



Diffusore - Diffuser

Codice-Code 00 5094

Le lampadine vengono fornite solo su richiesta

Bulbs supplied only on request

Gli apparecchi vengono forniti completi di cassafornia

The holder is enclosed to the luminaire

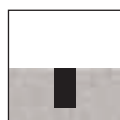

Incasso a terra
Recessed ground version

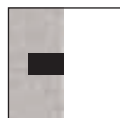

Incasso a parete
Recessed wall version

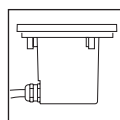

Entrata singola cavi di alimentazione con pressacavi PG 7 (Ø 3,5÷7 mm). Usare cavi flessibili. (Cavi rigidi possono compromettere la tenuta stagna IP67).
Single power supply entry cable with PG 7 (Ø 3,5÷7 mm) cable glands. Use flexible cables (rigid cables may compromise IP 67 rating)

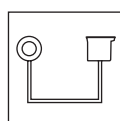

5094 530
L'apparecchio necessita di trasformatore remoto 230V/12V posizionato all'inizio della linea di alimentazione.
The transformer (230V-12V) for low voltage must be installed in the remote position

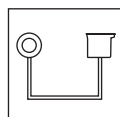

5094 LED
L'apparecchio necessita di alimentatore remoto elettronico 12-24V dc
The luminaire needs a remote power supplier 12-24V dc

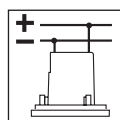

Connessione in parallelo.
Parallel connection.

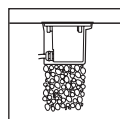

La cassafornia deve essere installata a filo terreno, prevedendo ghiaia di drenaggio per almeno 30 cm.
Ground luminaire. The box must be recessed into the ground providing a drainage-gravel for at least 30 cm



CS 74
Cassafornia in tecnopolimero per vano ad incasso h 94 mm - 114 x 85 mm - Ø 64
Technopolymer holder h 94 mm - 114 x 85 mm Ø 64

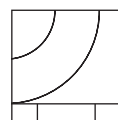

Carico massimo:
Kg 2000 a velocità max 30 Km/h
Maximum load:
Kg 2000 at 30/Km/h max speed

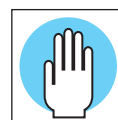

Simbolo che indica la temperatura superficiale sul vetro T<70°C (dati rilevati a ta di 15°C)
Glass surface temperature T<70°C (ambient temperature data of 15°C)

Temperatura calotta (ta 15°C) | Zona di installazione:
Cover's temperature (ta 15°C) | Intended usage:

1 LED	1,1 W	<40°C	5
QR-CBC 35	10 W	60°C	3/4

NOTA: zona di installazione definita dalla norma EN 60598-2-13 Allegato A - Vedi pag. 377

Note: intended usage is defined by the standard EN 60598-2-13 Annex A - See pag. 377



5094 LED

5094.010 1LED bianco/white max 1,1W 12-24V dc 100 lm 6300 K
 Con trasformatore remoto (non fornito) / Remote transformer (not supplied)

5094.020 1LED blu/blue max 1,1W 12-24V dc 40 lm
 Con trasformatore remoto (non fornito) / Remote transformer (not supplied)

5094.030 1LED rosso/red max 1,1W 12-24V dc 50 lm
 Con trasformatore remoto (non fornito) / Remote transformer (not supplied)

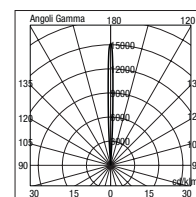
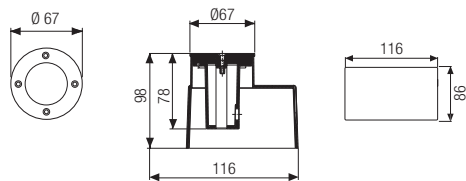

5094 01



5094

5094.530  QR-CBC35 10W GU4 12V
 Con trasformatore remoto (non fornito) / Remote transformer (not supplied)

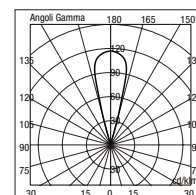
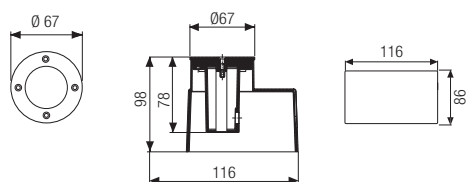

5094 53

GEO Ø120

Apparecchio da incasso a terra, per esterni costituito da:

- Corpo in alluminio pressofuso verniciato
- Anello frontale in acciaio inox AISI 316 o in alluminio pressofuso
- Diffusore in vetro satinato temperato
- Parabola riflettente in alluminio
- Guarnizione in silicone
- Viti di chiusura in acciaio inox
- Controcassa in tecnopolimero
- Verniciatura in polveri poliestere ad elevata resistenza ai raggi ultravioletti e alla corrosione

Outdoor recessed ground luminaire constructed of:

- Painted die-cast aluminium body
- Stainless steel AISI 316 or die-cast aluminium ring
- Satin tempered glass diffuser
- Aluminium reflector
- Silicon gasket
- Stainless steel screws
- Technopolymer holder
- Painting using high resistance to UV and corrosion polyester powders



CL I QT14 / T2 / 1 LED

CL III QT12 12V

Colori - Colours per-for Cod. 5080

X=3 Nero Black
 X=9 Antracite Anthracite X=4 Silver

Diffusore - Diffuser

Codice-Code 00 4010 per-for Cod. 5080

Codice-Code 00 6010 per-for Cod. 5081 - 5082

Le lampadine vengono fornite solo su richiesta ad eccezione della versione T2 6W e 60 LED
 Bulbs supplied only on request except for T2 6W and 60 LED version

Gli apparecchi vengono forniti completi di cassaforma
 The holder is enclosed to the luminaire



Incasso a terra
 Recessed ground version

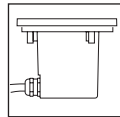

Entrata singola cavi di alimentazione con pressacavi M16 (Ø 5÷10 mm). Usare cavi flessibili. (Cavi rigidi possono compromettere la tenuta stagna IP67).
 Single power supply entry cable with M16 cable glands. Use flexible cables (rigid cables may compromise IP 67 rating)

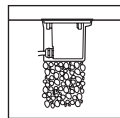

La cassaforma deve essere installata a filo terreno, prevedendo ghiaia di drenaggio per almeno 30 cm.
 Ground luminaire. The holder must be recessed into the ground providing a drainage-gravel for at least 30 cm

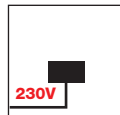

LED - art. 5080.88X - 5081.88X - 5082.88X
 Led a tensione di rete 220/240V 50Hz.
 Connessione diretta alla rete di alimentazione senza necessità di trasformatore.
 LED's direct operation at 220/240V 50Hz. No transformer is required.

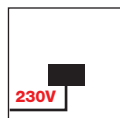

12 LED
 L'apparecchio è fornito completo di alimentatore elettronico Full Range 100/240V 50/60Hz posizionato all'interno dell'apparecchio.
 The luminaire is supplied with a Full Range 100/240V 50/60Hz built-in transformer

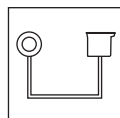

Per/for QT9 - QT12 /12V
 L'apparecchio necessita di trasformatore remoto 230V/12V posizionato all'inizio della linea di alimentazione.
 The feeding transformer (230V-12V) for low voltage must be installed in the remote position

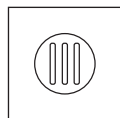

Fluorescente 6W Gx53
 Non necessita di alcun alimentatore.
 Fluorescent lamp 6W Gx53
 Does not need the power supplier

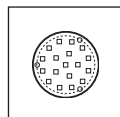

60 LED Gx53
 Non necessita di alcun alimentatore.
 60 LED Gx53
 Does not need the power supplier

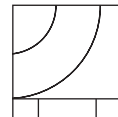

Carico massimo:
 Kg 2000 a velocità max 30 Km/h
 Maximum load:
 Kg 2000 at 30/Km/h max speed



IK 09



Simbolo che indica la temperatura superficiale sul vetro T<70°C (dati rilevati a ta per esterni di 15°C)
 Glass surface temperature T<70°C (ambient temperature data of 15°C)

	Temperatura calotta (ta 15°C) Cover's temperature (ta 15°C)		Zona di installazione: Intended usage:
	Power (W)	Temperature (°C)	
QT9	20W	80° C	2
QT12	50W	145°C	1
QT14	25W	85°C	2
QT14	40W	158°C	1
T2	6W	<40°C	5
1LED	4,1W	<40°C	5
12LED	9W	<40°C	5
60LED	4W	<40°C	5

NOTA: zona di installazione definita dalla norma EN 60598-2-13 Allegato A - Vedi pag. 377
 Note: intended usage is defined by the standard EN 60598-2-13 Annex A - See pag. 377



5080

5080.09X		QT9	20W	G4	12V
Con trasformatore remoto (non fornito) / Remote transformer (not supplied)					
5080.12X		QT12	50W	GY 6.35	12V
Con trasformatore remoto (non fornito) / Remote transformer (not supplied)					
5080.13X		QT14 Halopin	25W	G9	
5080.14X		QT14 Halopin	40W	G9	
5080.60X		T2	6W	Gx53	
5080.68X		60LED bianco/white	4W	Gx53	260 lm 4000 K
5080.16X		12LED bianco/white	6W		25 lm 6000 K
5080.88X		1LED bianco/white	4,1W		230 lm 6300 K

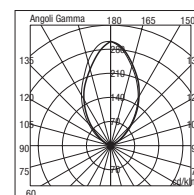

5080 14

Anello in alluminio
Die-cast aluminium ring

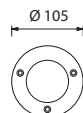

5081

5081.090		QT9	20W	G4	12V
Con trasformatore remoto (non fornito) / Remote transformer (not supplied)					
5081.120		QT12	50W	GY 6.35	12V
Con trasformatore remoto (non fornito) / Remote transformer (not supplied)					
5081.130		QT14 Halopin	25W	G9	
5081.140		QT14 Halopin	40W	G9	
5081.600		T2	6W	Gx53	
5081.680		60LED bianco/white	4W	Gx53	260 lm 4000 K
5081.160		12LED bianco/white	6W		25 lm 6000 K
5081.880		1LED bianco/white	4,1W		230 lm 6300 K

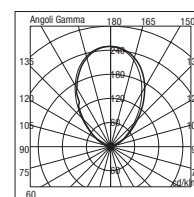

5081 60

Anello in acciaio inox
Stainless steel ring

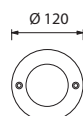

5082

5082.090		QT9	20W	G4	12V
Con trasformatore remoto (non fornito) / Remote transformer (not supplied)					
5082.120		QT12	50W	GY 6.35	12V
Con trasformatore remoto (non fornito) / Remote transformer (not supplied)					
5082.130		QT14 Halopin	25W	G9	
5082.140		QT14 Halopin	40W	G9	
5082.600		T2	6W	Gx53	
5082.680		60LED bianco/white	4W	Gx53	260 lm 4000 K
5082.160		12LED bianco/white	6W		25 lm 6000 K
5082.880		1LED bianco/white	4,1W		230 lm 6300 K

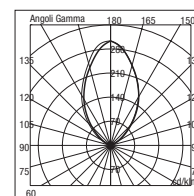

5082 14

Copertura in acciaio inox
Stainless steel cover

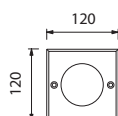

CS5087
(per/for T2 6W - 60LED)
Cassaforma in tecnopolimero
per vano ad incasso
Ø mm 112/130 - h mm 100
Technopolymer holder to be
recessed Ø mm 112/130
h mm 100

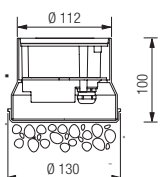

CS5080
(per/for QT12 - QT14 40W)
Cassaforma in tecnopolimero
per vano ad incasso
Ø mm 110 - h mm 155
Technopolymer holder to be
recessed Ø mm 110 - h mm 155

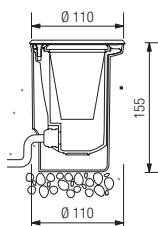

CS4010
(per/for QT9 - QT14 25W
1LED - 12LED)
Cassaforma in tecnopolimero
per vano ad incasso
Ø mm 110 - h mm 97
Technopolymer holder to be
recessed Ø mm 110 - h mm 97

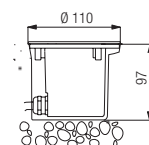

- L'apparecchio viene fornito completo di lampadina
Bulb enclosed to the luminaire

GEO Ø163

Apparecchio da incasso a terra per esterni costituito da:

- Struttura in alluminio pressofuso
- Anello frontale in acciaio inox AISI 316 o in alluminio pressofuso
- Diffusore in vetro trasparente
- Riflettore in alluminio
- Guarnizioni in silicone
- Viti di chiusura in acciaio inox
- Pozzetto in tecnopolimero
- Verniciatura in polveri poliestere ad elevata resistenza ai raggi ultravioletti e alla corrosione

Outdoor recessed ground luminaire constructed of:

- Painted die-cast aluminium structure
- Stainless steel AISI 316 or die-cast aluminium ring
- Transparent glass diffuser
- Aluminium reflector
- Silicon gaskets
- Stainless steel screws
- Technopolymer holder
- Painting using high resistance to UV and corrosion polyester powders



Colori per copertura in alluminio
Colours for aluminium cover

- X=3 Nero
Black
- X=9 Antracite
Anthracite
- X=4 Silver

Diffusore - Diffuser

Codice-Code 00 5090

Le lampadine vengono fornite solo su richiesta

Bulbs supplied only on request

Gli apparecchi vengono forniti completi di cassaforma

The holder is enclosed to the luminaire



Incasso a terra
Recessed ground version

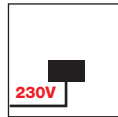

LED - art. 5090.88X - 5091.880
Led a tensione di rete 220/240V 50Hz.
Connessione diretta alla rete di alimentazione senza necessità di trasformatore.
LED's direct operation at 220/240V 50Hz.
No transformer is required.

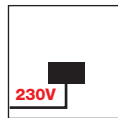

3 LED
L'apparecchio è fornito completo di alimentatore elettronico Full Range 100/240V 50/60Hz posizionato all'interno dell'apparecchio.
The luminaire is supplied with a Full Range 100/240V 50/60Hz built-in transformer

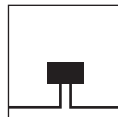

Entrata doppia cavi di alimentazione con presacavi M16 (Ø 5÷10 mm). Usare cavi flessibili. (Cavi rigidi possono compromettere la tenuta stagna IP67).

Double power supply entry cables with M16 cable glands. Use flexible cables (rigid cables may compromise IP 67 rating)

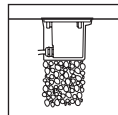

La cassaforma deve essere installata a filo terreno, prevedendo ghiaia di drenaggio per almeno 30 cm.
The holder must be recessed into the ground providing a drainage-gravel for at least 30 cm



CS 91
Controcassa in tecnopolimero
Technopolymer holder
Ø 158/120 mm - h 207 mm

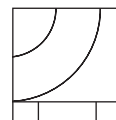

Carico massimo:
Kg 2000 a velocità max 30 Km/h
Maximum load:
Kg 2000 at 30/Km/h max speed



Simbolo che indica la temperatura superficiale sul vetro T<70°C (dati rilevati a ta per esterni di 15°C)
Glass surface temperature T<70°C (ambient temperature data of 15°C)

Temperatura calotta (ta 15°C) | Zona di installazione:
Cover's temperature (ta 15°C) | Intended usage:

Q PAR 20	50W	145°C	1
Q PAR 16	40W	145°C	1
1 LED	4,1W	<40°C	5
3 LED	9W	<40°C	5

NOTA: zona di installazione definita dalla norma EN 60598-2-13 Allegato A - Vedi pag. 377

Note: intended usage is defined by the standard EN 60598-2-13 Annex A - See pag. 377



ACCESSORIO:
FILTRI COLORATI
Negli apparecchi Geo Ø 163 è possibile inserire filtri dicroici colorati per ottenere effetti suggestivi.

Cod. 7758
ROSSO/RED

CHROMATIC FILTERS
Chromatic filters can be applied to the Geo Ø 163 luminaire, thus creating scenographic effects and dreaming atmospheres.

Cod. 7757
BLU/BLUE

Cod. 7759
VERDE/GREEN



5091

Copertura in acciaio inox
Stainless steel cover

5091.000		Q PAR20	50W	E27
Pos. lampadina fissa / Lamp position: not tilting				
5091.150		Q PAR16	40W	E14
Pos. lampadina basculante ± 30° / Lamp position: tilting ± 30°				
5091.880		1LED bianco/white	4,1W	230 lm 6300 K

Modulo da 3 LED orientabile ± 30° con lente 20/25°
3 LED adjustable module ± 30° with 20/25° lens

5091.660		3LED bianco/white	9W	500 lm 6300 K
Con alimentatore elettronico incorporato / Built-in electronic power supplier				

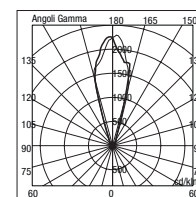
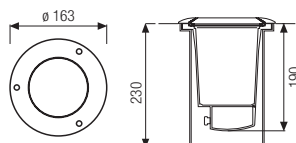

5091 00

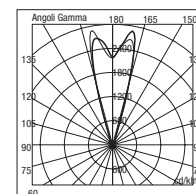

5091 66

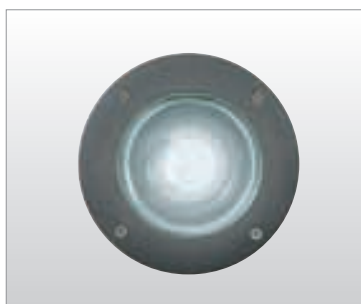

5090

Copertura in alluminio
Die-cast aluminium cover

5090.00X		Q PAR20	50W	E27
Pos. lampadina fissa / Lamp position: not tilting				
5090.15X		Q PAR16	40W	E14
Pos. lampadina basculante ± 30° / Lamp position: tilting ± 30°				
5090.88X		1LED bianco/white	4,1W	230 lm 6300 K

Modulo da 3 LED orientabile ± 30° con lente 20/25°
3 LED adjustable module ± 30° with 20/25° lens

5090.66X		3LED bianco/white	9W	500 lm 6300 K
Con alimentatore elettronico incorporato / Built-in electronic power supplier				

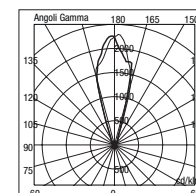
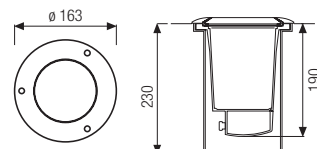

5090 00

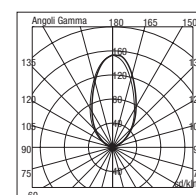

5090 15



GEO Ø220

Apparecchio da incasso a terra per esterni costituito da:

- Struttura in alluminio pressofuso
- Anello frontale in acciaio inox AISI 316 (disponibile in forma rotonda o quadrata) o in alluminio pressofuso
- Griglia frangiluce in alluminio pressofuso (a richiesta)
- Diffusore in vetro trasparente o satinato
- Riflettore in alluminio
- Guarnizioni in silicone
- Viti di chiusura in acciaio inox
- Pozzetto in polipropilene
- Verniciatura in polveri poliesteri ad elevata resistenza ai raggi ultravioletti e alla corrosione

Outdoor recessed ground luminaire

Constructed of:

- Painted die-cast aluminium structure
- Stainless steel AISI 316 (available in round or square shape) or die-cast aluminium ring
- Die-cast aluminium diffuser grid (on request)
- Transparent or satin glass diffuser
- Aluminium reflector
- Silicon gaskets
- Stainless steel screws
- Polypropylene holder
- Painting using high resistance to UV and corrosion polyester powders



CON ANELLO INOX

Diffusore trasparente: 00 2060
Diffusore satinato: 00 2166

With inox ring

Transparent diffuser: 00 2060
Satin diffuser: 002166

CON ANELLO ALLUMINIO

Diffusore trasparente: 00 3060
Diffusore satinato: 00 3166

With aluminium ring

Transparent diffuser: 00 3060
Satin diffuser: 00 3166

Le lampadine vengono fornite solo su richiesta ad eccezione della versione T2 6W e 60 LED

Bulbs supplied only on request except for T2 6W and 60 LED version

Gli apparecchi vengono forniti completi di cassaforma

The holder is enclosed to the luminaire

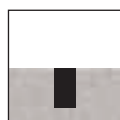

Incasso a terra
Recessed ground version

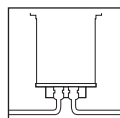

Doppia entrata cavi di alimentazione con presacavi PG13,5 (ø 6÷12 mm). Usare cavi flessibili per non compromettere la tenuta stagna IP67.
Double entrance of the supply cables with gland type PG 13,5(ø 6÷12 mm). Use only flexible cables to grant protection against water exposure (IP 67)

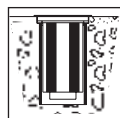

La cassaforma deve essere installata a filo terreno, prevedendo ghiaia di drenaggio per almeno 30 cm.
The holder must be recessed into the ground providing a drainage-gravel for at least 30 cm

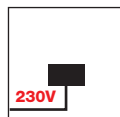

LED - art. 2063.88X
Led a tensione di rete 220/240V 50Hz. Connessione diretta alla rete di alimentazione senza necessità di trasformatore.
LED's direct operation at 220/240V 50Hz. No transformer is required.

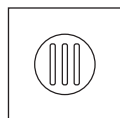

Fluorescente 6W Gx53
Non necessita di alcun alimentatore.
Fluorescent lamp 6W Gx53
Does not need the power supplier

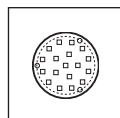

60 LED Gx53
Non necessita di alcun alimentatore.
60 LED Gx53
Does not need the power supplier

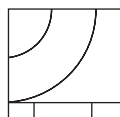

Carico massimo:
Kg 3500 a velocità max 30 Km/h
Maximum load:
Kg 3500 at 30/Km/h max speed



CS 2060
CS 2066
CS 1084
Pozzetto in polipropilene
Polypropylene holder Ø 180 mm



ACCESSORIO: GR 60
Griglia frangiluce Silver
Silver diffuser grid
Ø 135 mm



Simbolo che indica la temperatura superficiale sul vetro T<70°C (dati rilevati a ta per esterni di 15°C)
Glass surface temperature T<70°C (ambient temperature data of 15°C)

Temperatura calotta (ta 15°C)
Cover's temperature (ta 15°C)

Vetro trasparente / Transparent glass Vetro satinato / Satin glass

		Zona di installazione: Intended usage:	
Q PAR30	75W 135°C		1
TC-T	18W 61°C 69°C		3/4
QR111	75W 205°C		1
HIE	70W 130°C 142°C		1
HSE	70W 112°C 123°C		1
HME	80W 140°C		1
TC-T	26W 69°C 80°C		3/4
Q PAR38	80W 145°C		1
T2	6W <40°C		5
60LED	4W <40°C		5
1LED	4,1W <40°C		5

NOTA: zona di installazione definita dalla norma EN 60598-2-13 Allegato A - Vedi pag. 377

Note: intended usage is defined by the standard EN 60598-2-13 Annex A - See pag. 377

Direttiva/Directive
EuP/ErP (2005/52/CE-2009/125/CE)

Gli apparecchi per lampade a scarica ad alta intensità sono progettati per lampade chiare e opali.
Luminaires for high intensity discharge lamps are designed for either clear and coated lamps.



2060

Vetro Trasparente - Transparent glass

2060.000  Q PAR30 75W E27

Posizione lampadina: basculante - Lamp position: tilting

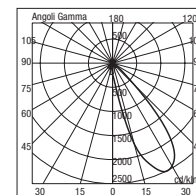
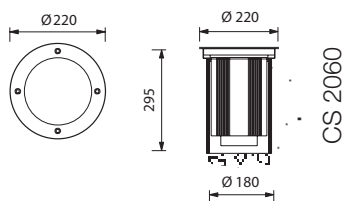

2060 00



2068

Vetro Trasparente - Transparent glass

2068.840  TC-T 18W GX24 d-2

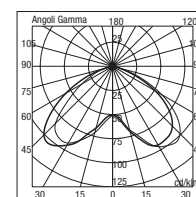
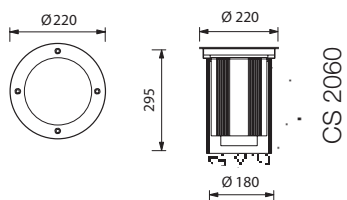

2068 84



2061

Vetro Trasparente - Transparent glass

2061.070  QR111 75W G53

Posizione lampadina: basculante - Lamp position: tilting

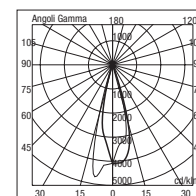
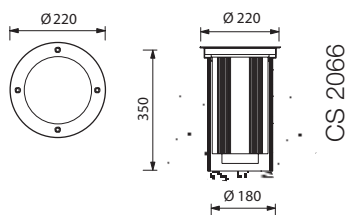

2061 07



2067

Vetro Trasparente - Transparent glass

2067.730  HIE 70W E27

2067.740  HSE 70W E27

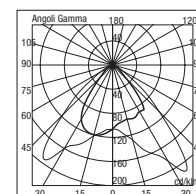
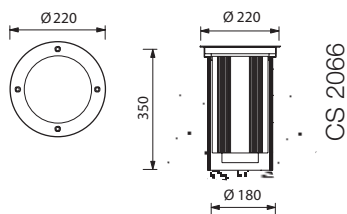

2067 73

GEO Ø220

GEO Ø220



2062

Vetro Trasparente - Transparent glass

2062.710  HME 80W E27

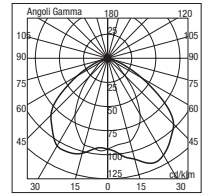
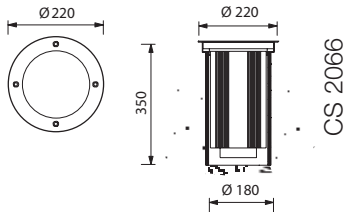

2062 71



2066

Vetro Trasparente - Transparent glass

2066.830  TC-T 26W GX24 d-3

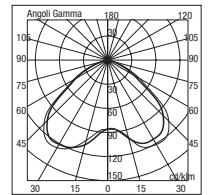
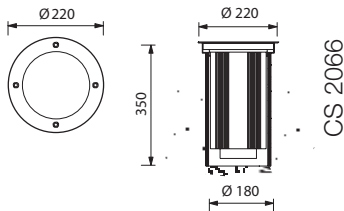

2066 83



2160

Vetro Trasparente - Transparent glass

2160.000  Q PAR38 80W E27

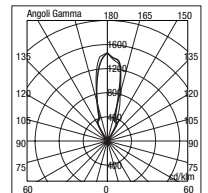
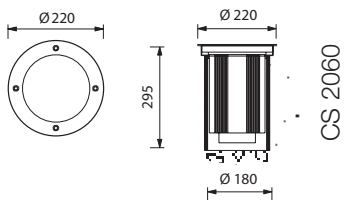

2160 00



2166 - 2167 - 2168

Vetro satinato - Satin glass

2168.840  TC-T 18W GX24 d-2

2166.830  TC-T 26W GX24 d-3

2167.730  HIE 70W E27

2167.740  HSE 70W E27

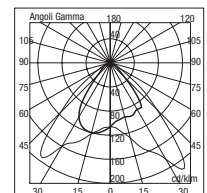
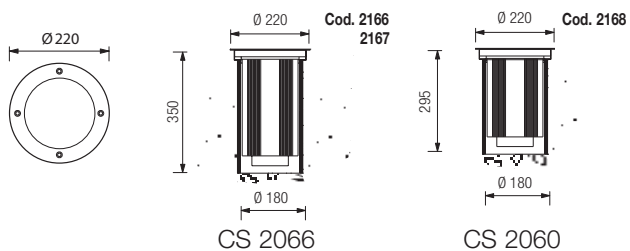

2167 73



2063

Vetro satinato - Satin glass

- **2063.600** T2 6W Gx53
- **2063.680** 60LED bianco/white 4W Gx53 260 lm 4000 K
- 2063.880** 1LED bianco/white 4,1W 230 lm 6300 K

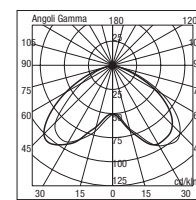
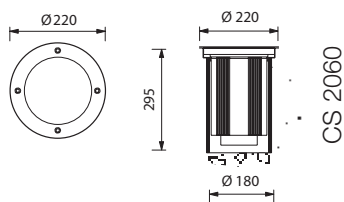

2063 60

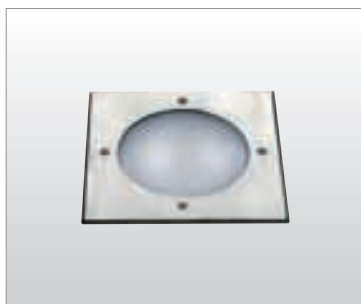

QUADRA

**VERSIONE QUADRA
SQUARE TYPE**

Vetro satinato - Satin glass

- 2367.730** HIE 70W E27
- 2367.740** HSE 70W E27
- 2368.840** TC-T 18W GX24 d-2
- 2366.830** TC-T 26W GX24 d-3

Vetro Trasparente - Transparent glass

- 2260.000** Q PAR30 75W E27
Posizione lampadina: basculante - Lamp position: tilting
- 2268.840** TC-T 18W GX24 d-2
- 2261.070** QR111 75W G53
Posizione lampadina: basculante - Lamp position: tilting
- 2267.730** HIE 70W E27
- 2267.740** HSE 70W E27
- 2262.710** HM E 80W E27
- 2266.830** TC-T 26W GX24 d-3
- 2360.000** Q PAR38 80W E27

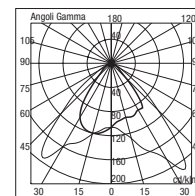

2367 73

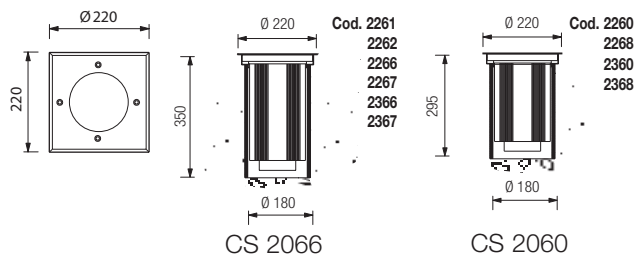

- L'apparecchio viene fornito completo di lampadina
Bulb enclosed to the luminaire

GEO Ø220

GEO Ø220

Anello frontale in alluminio verniciato nero
Black die cast aluminium bezel

ANELLO ALLUMINIO perfettamente a filo pavimento (sporgenza 0 mm)
in modo da non intralciare il camminamento
Perfectly flush with the floor **ALUMINIUM RING** (projection 0 mm)
as do not obstacle the walking

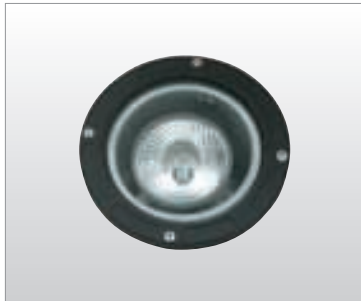

3060

Vetro Trasparente - Transparent glass

3060.003  Q PAR30 75W E27

Posizione lampadina: basculante - Lamp position: tilting

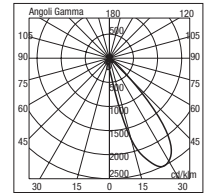
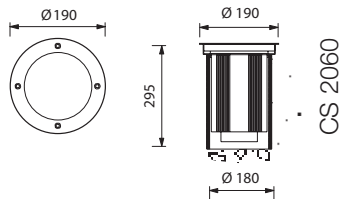

3060 00

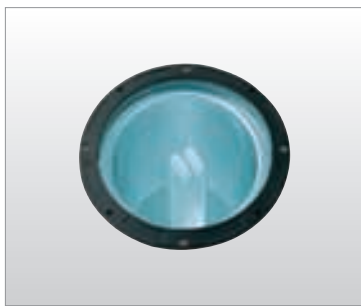

3068

Vetro Trasparente - Transparent glass

3068.843  TC-T 18W GX24 d-2

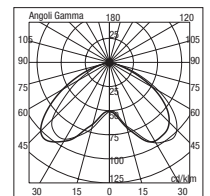
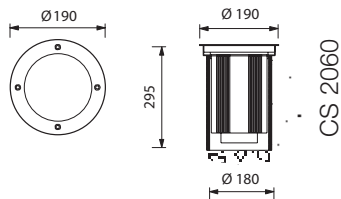

3068 84

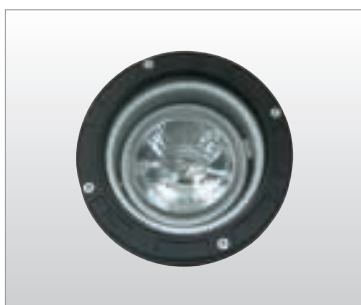

3061

Vetro Trasparente - Transparent glass

3061.073  QR111 75W G53

Posizione lampadina: basculante - Lamp position: tilting

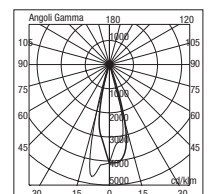
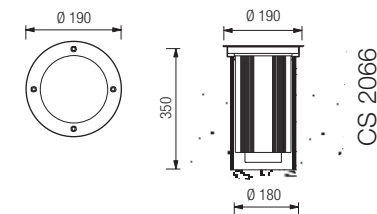

3061 07

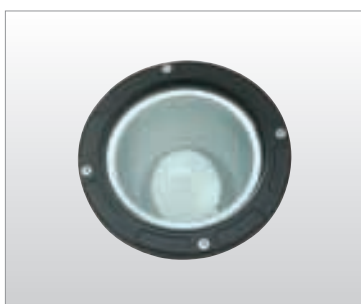

3067

Vetro Trasparente - Transparent glass

3067.733  HIE 70W E27

3067.743  HSE 70W E27

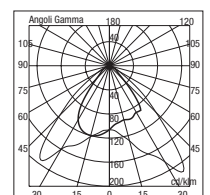
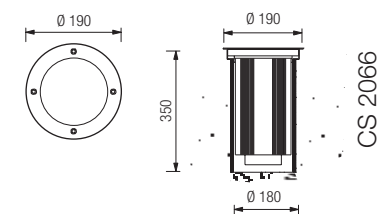

3067 73

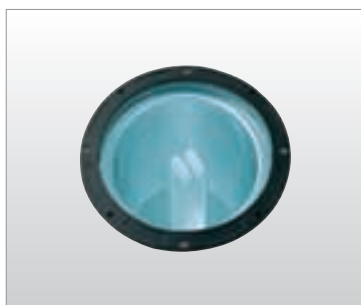

3066

Vetro Trasparente - Transparent glass

3066.833  TC-T 26W GX24 d-3

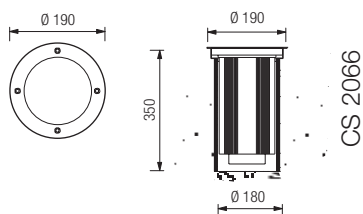

CS 2066

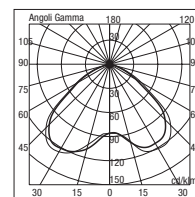

3066 83

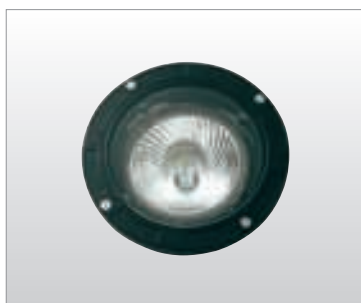

3160

Vetro Trasparente - Transparent glass

3160.003  Q PAR38 80W E27

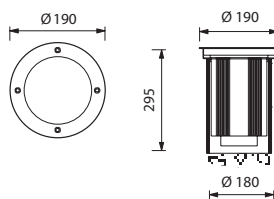

CS 2060

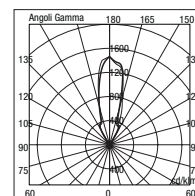

3160 00

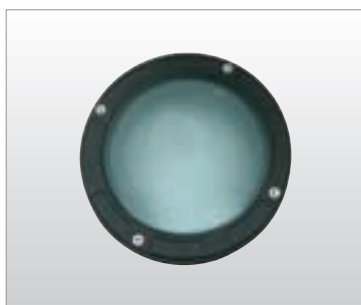



3166 - 3167 - 3168

Vetro satinato - Satin glass

3168.843  TC-T 18W GX24 d-2

3166.833  TC-T 26W GX24 d-3

3167.733  HIE 70W E27

3167.743  HSE 70W E27

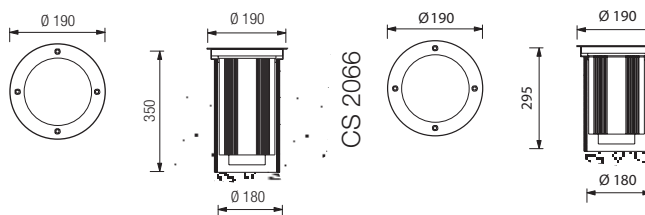

CS 2066

CS 2060

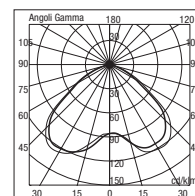

3166 83

GEO Ø245

Apparecchio da incasso a terra per esterni costituito da:

- Struttura in alluminio pressofuso
- Anello frontale in acciaio inox AISI 316 o in alluminio pressofuso
- Diffusore in vetro trasparente
- Riflettore in alluminio
- Guarnizioni in silicone
- Viti di chiusura in acciaio inox
- Controcassa in tecnopolimero
- Verniciatura in polveri poliestere ad elevata resistenza ai raggi ultravioletti e alla corrosione

Outdoor recessed ground luminaire constructed of:

- Painted die-cast aluminium structure
- Stainless steel AISI 316 or die-cast aluminium ring
- Transparent glass diffuser
- Aluminium reflector
- Silicon gaskets
- Stainless steel screws
- Technopolymer holder
- Painting using high resistance to UV and corrosion polyester powders



Colori per copertura in alluminio
Colours for aluminium cover

- X=3** Nero
Black
- X=9** Antracite
Anthracite
- X=4** Silver

Diffusore - Diffuser

Codice-Code **00 4070**
00 4470

Le lampadine vengono fornite solo su richiesta
Bulbs supplied only on request

Gli apparecchi vengono forniti completi di cassaforma
The holder is enclosed to the luminaire

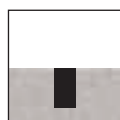

Incasso a terra
Recessed ground version

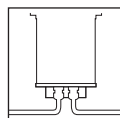

Doppia entrata cavi di alimentazione con presacavi PG13,5 (ø 6÷12 mm). Usare cavi flessibili per non compromettere la tenuta stagna IP67.
Double entrance of the supply cables with gland type PG 13,5(ø 6÷12 mm). Use only flexible cables to grant protection against water exposure (IP 67)



La cassaforma deve essere installata a filo terreno, prevedendo ghiaia di drenaggio per almeno 30 cm.
The holder must be recessed into the ground providing a drainage-gravel for at least 30 cm

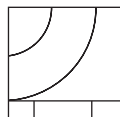

Carico massimo:
Kg 3500 a velocità max 30 Km/h
Maximum load:
Kg 3500 at 30/Km/h max speed

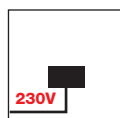

LED - art. 4070.880 - 4270.880 - 4470.880
Led a tensione di rete 220/240V 50Hz.
Connessione diretta alla rete di alimentazione senza necessità di trasformatore.
LED's operation at 220/240V 50Hz voltage directly.
No transformer is required.

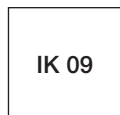

IK 09



CS 90
Controcassa in tecnopolimero
h 367 mm - Ø 230/180 mm
technopolymer holder
h 367 mm - Ø 230/180 mm

È molto importante che il bordo superficiale del tubo-pozzetto non fuoriesca dal terreno, rimanendo esattamente allo stesso livello.

It is important that the back box is installed flush with the ground.



Simbolo che indica la temperatura superficiale sul vetro T<70°C (dati rilevati a ta per esterni di 15°C)
Glass surface temperature T<70°C (ambient temperature data of 15°C)

Temperatura calotta (ta 15°C)
Cover's temperature (ta 15°C)

Zona di installazione:
Intended usage:

HIT	35W	95°C	2
HIT	70W	110°C	1
HIT-DE	70W	128°C	1
TC-T	26W	65°C	3/4
3LED	12,3W	< 50°C	4/5

NOTA: zona di installazione definita dalla norma EN 60598-2-13 Allegato A - Vedi pag. 377

Note: intended usage is defined by the standard EN 60598-2-13 Annex A - See pag. 377

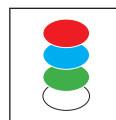

Cod. 7748
ROSSO/RED

Cod. 7747
BLU/BLUE

Cod. 7749
VERDE/GREEN

Cod. 7740
ANTICALORICO/
HEAT-DISSIPATING

ACCESSORIO:

Negli apparecchi Geo Ø 245 è possibile inserire filtri dicromatici colorati e filtri anticalorici. Non si possono mettere contemporaneamente filtri colorati e filtri anticalorici. I filtri dicromatici colorati e i filtri anticalorici vanno installati sotto il vetro di protezione utilizzando gli appositi anelli di sostegno forniti con gli stessi.

Dichroic chromatic filters and heat-dissipating filters can be applied to the Geo Ø 245 luminaires. The chromatic and heat-dissipating filters can't be applied simultaneously. The chromatic and heat-dissipating filters must be applied under the safety glass diffuser, using the proper rings which are supplied with them.

L'utilizzo del filtro anticalorico è consentito solo per le versioni:

HIT 35W G12 - TC-T 26W

Heat-dissipating filter can be applied only to the following versions:
HIT 35W G12 - TC-T 26W

Direttiva/Directive

EuP/ErP (2005/52/CE-2009/125/CE)

Gli apparecchi per lampade a scarica ad alta intensità sono progettati per lampade chiare e opali.

Luminaires for high intensity discharge lamps are designed for either clear and coated lamps.

ANELLO INOX perfettamente a filo pavimento (sporgenza 0 mm)
in modo da non intralciare il camminamento
 Perfectly flush with the floor INOX RING (projection 0 mm)
 as do not obstacle the walking

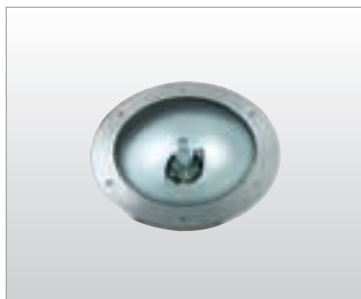

4070

- **4070.350**  HIT 35W G12
 Riflettore simmetrico - Pos. lampadina basculante $\pm 15^\circ$
 Symmetrical reflector - Lamp position: tilting $\pm 15^\circ$
- **Con filtro anticalorico** - With heat dissipating filter T < 70°C
- **4070.770**  HIT 70W G12
 Riflettore simmetrico - Pos. lampadina basculante $\pm 15^\circ$
 Symmetrical reflector - Lamp position: tilting $\pm 15^\circ$
- **4070.880** 3LED bianco/white 12,3W 690 lm 6300 K

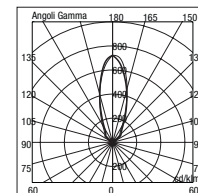

4070 77

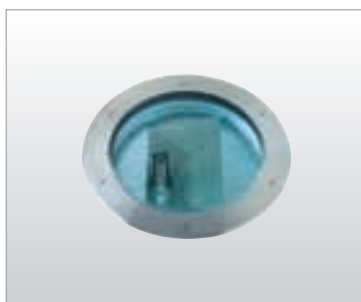
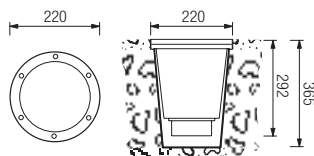

4071

- **4071.780**  HIT-DE 70W Rx7s
 Riflettore asimmetrico - Asymmetrical reflector

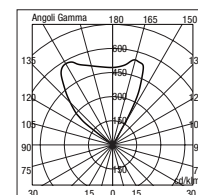

4071 78

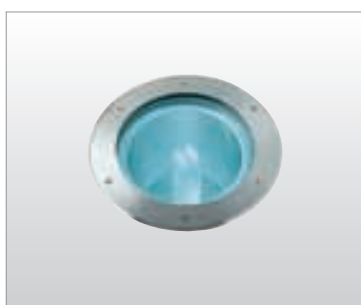
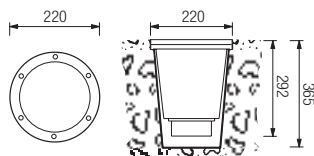

4076

- **4076.830**  TC-T 26W GX24 d-3
 ● **Con filtro anticalorico** - With heat dissipating filter T < 40°C

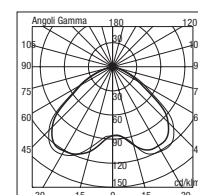

4076 83

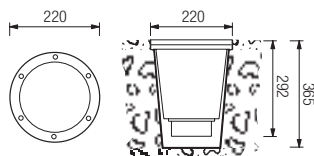

GEO Ø245

GEO Ø245

ANELLO INOX con sporgenza fuori terra inferiore a 5 mm
 INOX RING with projection from the ground less than 5 mm



4270

● **4270.350**  HIT 35W G12

Riflettore simmetrico - Pos. lampadina basculante $\pm 15^\circ$
 Symmetrical reflector - Lamp position: tilting $\pm 15^\circ$

● Con filtro anticalorico - With heat dissipating filter $T < 70^\circ\text{C}$

4270.770  HIT 70W G12

Riflettore simmetrico - Pos. lampadina basculante $\pm 15^\circ$
 Symmetrical reflector - Lamp position: tilting $\pm 15^\circ$

4270.880 3LED bianco/white 12,3W 690 lm 6300 K

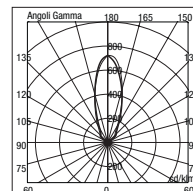
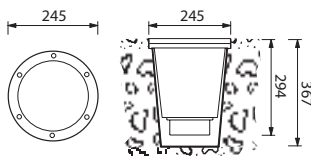

4270 77

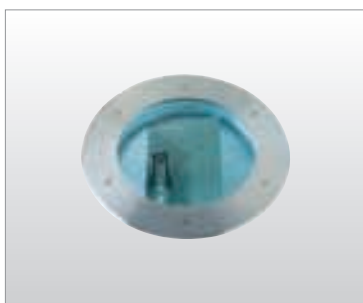

4271

4271.780  HIT-DE 70W Rx7s

Riflettore asimmetrico - Asymmetrical reflector

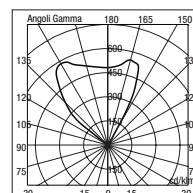
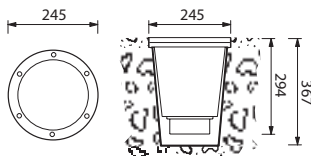

4271 78

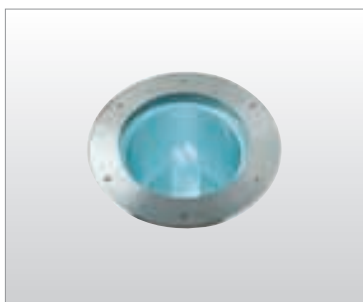

4276

● **4276.830**  TC-T 26W GX24 d-3

● Con filtro anticalorico - With heat dissipating filter $T < 40^\circ\text{C}$

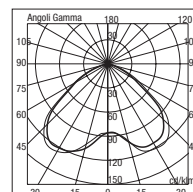
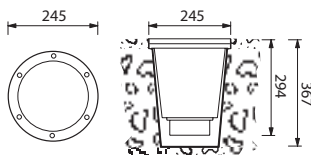

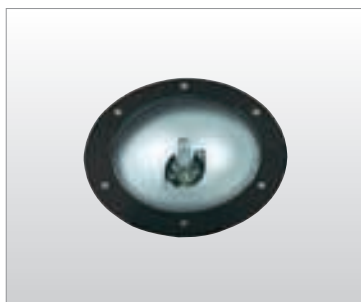

4276 83

ANELLO ALLUMINIO perfettamente a filo pavimento (sporgenza 0 mm)
in modo da non intralciare il camminamento
 Perfectly flush with the floor **ALUMINIUM RING** (projection 0 mm)
 as do not obstacle the walking



4470

- **4470.35X**  HIT 35W G12
 Riflettore simmetrico - Pos. lampadina basculante $\pm 15^\circ$
 Symmetrical reflector - Lamp position: tilting $\pm 15^\circ$
- Con filtro anticalorico - With heat dissipating filter T < 70°C
- **4470.77X**  HIT 70W G12
 Riflettore simmetrico - Pos. lampadina basculante $\pm 15^\circ$
 Symmetrical reflector - Lamp position: tilting $\pm 15^\circ$
- **4470.88X** 3LED bianco/white 12,3W 690 lm 6300 K

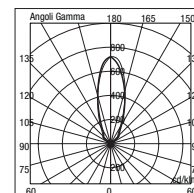
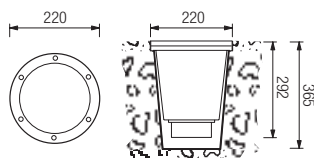

4470 77

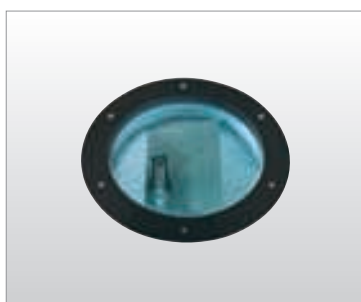

4471

- **4471.78X**  HIT-DE 70W Rx7s
 Riflettore asimmetrico - Asymmetrical reflector

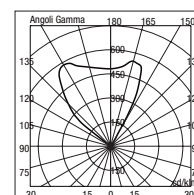
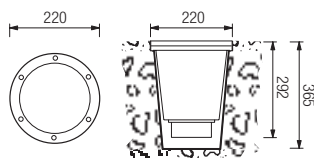

4471 78

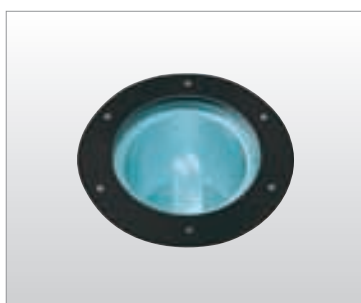

4476

- **4476.83X**  TC-T 26W GX24 d-3
 ● Con filtro anticalorico - With heat dissipating filter T < 40°C

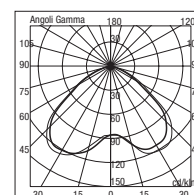
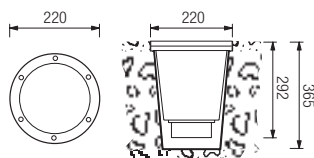

4476 83

GEO Ø275

Apparecchio da incasso a terra per esterni costituito da:

- Struttura in alluminio pressofuso
- Anello frontale in acciaio inox AISI 316 (disponibile in forma rotonda o quadrata) o in alluminio
- Griglia frangiluce in alluminio pressofuso (a richiesta)
- Diffusore in vetro trasparente o satinato
- Riflettore in alluminio
- Guarnizioni in silicone
- Viti di chiusura in acciaio inox
- Controcassa in tecnopolimero copolimero
- Verniciatura in polveri poliestere ad elevata resistenza ai raggi ultravioletti e alla corrosione

Outdoor recessed ground luminaire constructed of:

- Painted die-cast aluminium structure
- Stainless steel AISI 316 (available in round or square shape) or aluminium ring
- Die-cast aluminium diffuser grid (on request)
- Transparent or satin glass diffuser
- Aluminium reflector
- Silicon gaskets
- Stainless steel screws
- Technopolymer holder
- Painting using high resistance to UV and corrosion polyester powders



Diffusore - Diffuser

Codice-Code 00 1070

per/for Cod. 1070 - 1071 - 1072 - 1073 - 1270 - 1271 - 1272 - 1273

Codice-Code 00 1074

per/for Cod. 1074 - 1075 - 1274 - 1275

Codice-Code 00 2070

per/for Cod. 2070 - 2071 - 2072

Codice-Code 00 2074

per/for Cod. 2074 - 2075

Le lampadine vengono fornite solo su richiesta

Bulbs supplied only on request

Gli apparecchi vengono forniti completi di cassaforma

The holder is enclosed to the luminaire

L'utilizzo del filtro anticalorico è consentito

solo per le versioni: HIT 35W G12 - HIT 70W G12

Heat-dissipating filter can be applied only to the following versions: HIT 35W G12 - HIT 70W G12

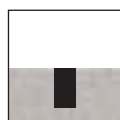

Incasso a terra
Recessed ground version

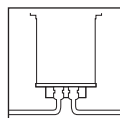

Doppia entrata cavi di alimentazione con presacavi PG13,5 (ø 6÷12 mm). Usare cavi flessibili per non compromettere la tenuta stagna IP67.
Double entrance of the supply cables with gland type PG 13,5(ø 6÷12 mm). Use only flexible cables to grant protection against water exposure (IP 67)



La cassaforma deve essere installata a filo terreno, prevedendo ghiaia di drenaggio per almeno 30 cm.
The holder must be recessed into the ground providing a drainage-gravel for at least 30 cm

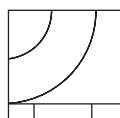

Carico massimo:
Kg 2000 a velocità max 30 Km/h
Maximum load:
Kg 2000 at 30/Km/h max speed



CS 70
Controcassa in tecnopolimero copolimero
Technopolymer holder
Ø 255 /190mm - h 350 mm

È molto importante che il bordo superficiale del tubopozzetto non fuoriesca dal terreno, rimanendo esattamente allo stesso livello.

It is important that the back box is installed flush with the ground.



ACCESSORIO: GR 70
Griglia frangiluce Silver
Silver diffuser grid
Ø 200 mm



Simbolo che indica la temperatura superficiale sul vetro T<70°C (dati rilevati a ta per esterni di 15°C)
Glass surface temperature T<70°C (ambient temperature data of 15°C)

Temperatura calotta (ta 15°C)
Cover's temperature (ta 15°C)

		Vetro trasparente Transparent glass	Vetro satinato Satin glass	Zona di installazione: Intended usage:
HIT	35W	52°C	59°C	3/4
HIT	70W	93°C	105°C	2
HIT-DE	70W	108°C	116°C	1
HME	80W	100°C	110°C	1
PAR38	120W	122°C	136°C	1

NOTA: zona di installazione definita dalla norma EN 60598-2-13 Allegato A - Vedi pag. 377

Note: intended usage is defined by the standard EN 60598-2-13 Annex A - See pag. 377

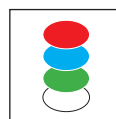

ACCESSORIO:

Negli apparecchi Geo Ø 275 è possibile inserire filtri dicroici colorati e filtri anticalorici. Non si possono mettere contemporaneamente filtri colorati e filtri anticalorici.

Cod. 7778
ROSSO/RED

Cod. 7777
BLU/BLUE

Cod. 7779
VERDE/GREEN

Cod. 7780
ANTICALORICO/
HEAT-DISSIPATING

- I filtri dicroici colorati servono ad ottenere effetti suggestivi.
- I filtri anticalorici hanno la funzione di abbassare la temperatura superficiale dei vetri, in modo da rendere gli apparecchi calpestabili (T<70°C). (Norma tecnica CEI EN 60598-2-13)

I filtri dicroici colorati e i filtri anticalorici vanno installati sotto il vetro di protezione.

Dichroic chromatic filters and heat-dissipating filters can be applied to the Geo Ø 275 luminaire.

The chromatic and heat-dissipating filters can't be applied simultaneously.

- The dichroic chromatic filters create scenographic effects and dreaming atmospheres
- The heat-dissipating filters reduce the temperature on the external glass surface under 70°C (T<70°C). (IEC EN 60598-2-13)

The chromatic and heat-dissipating filters must be supplied under the safety glass diffuser.

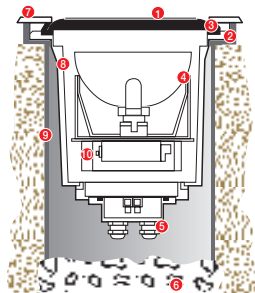

- 1 **Vetro temperato**
Protective glass cover
- 2 **Anello ferma vetro**
Glass cover retaining ring
- 3 **Guarnizione in silicone**
Silicon gasket
- 4 **Riflettore in alluminio**
Aluminium reflector
- 5 **Pressacavo PG 13.5**
Cable gland PG 13.5
- 6 **Ghiaia di drenaggio**
Drainage gravel
- 7 **Anello superiore alluminio pressofuso o inox**
Die-cast aluminium or stainless steel front bezel
- 8 **Corpo alluminio pressofuso**
Die-cast aluminium body
- 9 **Controcassa in tecnopolimero**
Polypropylene holder
- 10 **Gruppo di alimentazione**
Power supply unit



1070

Vetro Trasparente - Transparent glass

● **1070.350** HIT 35W G12

Riflettore simmetrico - Pos. lampadina basculante ± 15°
Symmetrical reflector - Lamp position: tilting ± 15°

● Con filtro anticalorico - With heat dissipating filter T < 70°C

● **1070.770** HIT 70W G12

Riflettore simmetrico - Pos. lampadina basculante ± 15°
Symmetrical reflector - Lamp position: tilting ± 15°

● Con filtro anticalorico - With heat dissipating filter T < 70°C

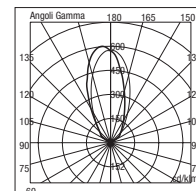
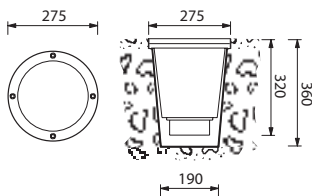

1070 77

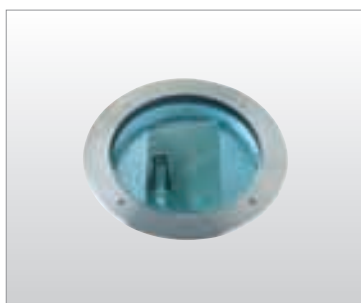

1071

Vetro Trasparente - Transparent glass

1071.780 HIT-DE 70W Rx7s

Riflettore asimmetrico - Asymmetrical reflector

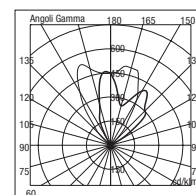
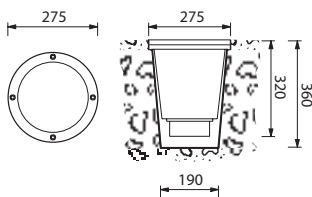

1071 78



1072

Vetro Trasparente - Transparent glass

1072.710 HME 80W E27

Riflettore simmetrico - Symmetrical reflector

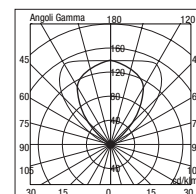
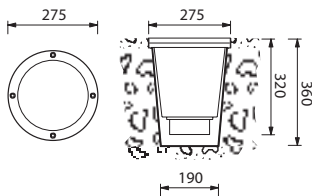

1072 71

Direttiva/Directive

EuP/ErP (2005/52/CE-2009/125/CE)

Gli apparecchi per lampade a scarica ad alta intensità sono progettati per lampade chiare e opali.

Luminaires for high intensity discharge lamps are designed for either clear and coated lamps.

GEO Ø275

GEO Ø275



1073

Vetro Trasparente - Transparent glass

1073.000  PAR38 120W E27

Riflettore simmetrico - Symmetrical reflector

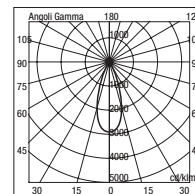
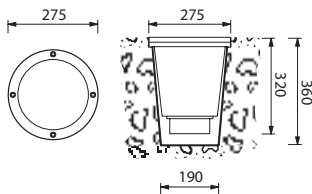

1073 00



1074 - 1075

Vetro satinato - Satin glass

1074.770  HIT 70W G12

Riflettore simmetrico - Pos. lampadina basculante
Symmetrical reflector - Lamp position: tilting

1075.710  HME 80W E27

Riflettore simmetrico - Symmetrical reflector

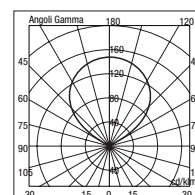
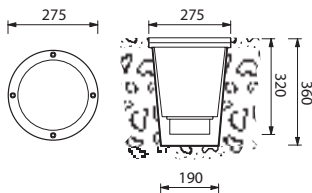

1075 71

VERSIONE QUADRA SQUARE TYPE



QUADRA

Vetro Trasparente - Transparent glass

1270.770  HIT 70W G12

Riflettore simmetrico - Pos. lampadina basculante
Symmetrical reflector - Lamp position: tilting

1271.780  HIT-DE 70W Rx7s

Riflettore asimmetrico - Asymmetrical reflector

1272.710  HME 80W E27

Riflettore simmetrico - Symmetrical reflector

1273.000  PAR38 120W E27

Riflettore simmetrico - Symmetrical reflector

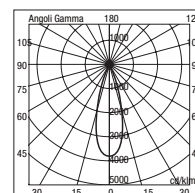

1273 00

Vetro satinato - Satin glass

1274.770  HIT 70W G12

Riflettore simmetrico - Pos. lampadina basculante
Symmetrical reflector - Lamp position: tilting

1275.710  HME 80W E27

Riflettore simmetrico - Symmetrical reflector

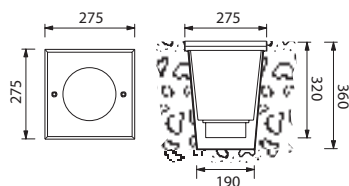

Anello frontale in alluminio verniciato nero
Black die cast aluminium bezel

ANELLO ALLUMINIO perfettamente a filo pavimento (sporgenza 0 mm)
in modo da non intralciare il camminamento

Perfectly flush with the floor ALUMINIUM RING (projection 0 mm)
as do not obstacle the walking

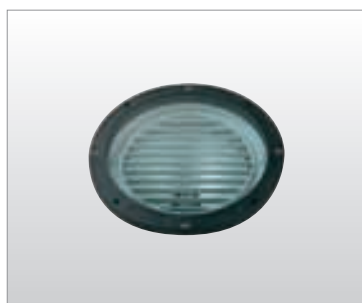

2070 - 2071 - 2072

Vetro Trasparente - Transparent glass

- **2070.353** HIT 35W G12

Riflettore simmetrico - Pos. lampadina basculante $\pm 15^\circ$

Symmetrical reflector - Lamp position: tilting $\pm 15^\circ$

- Con filtro anticalorico - With heat dissipating filter T < 70°C

- **2070.773** HIT 70W G12

Riflettore simmetrico - Pos. lampadina basculante

Symmetrical reflector - Lamp position: tilting

- Con filtro anticalorico - With heat dissipating filter T < 70°C

- **2071.783** HIT-DE 70W Rx7s

Riflettore asimmetrico - Asymmetrical reflector

- **2072.713** HME 80W E27

Riflettore simmetrico - Symmetrical reflector

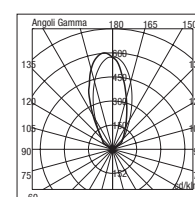
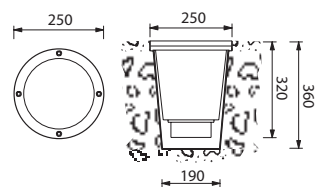

2070 77



2074 - 2075

Vetro satinato - Satin glass

- **2074.773** HIT 70W G12

Riflettore simmetrico - Pos. lampadina basculante

Symmetrical reflector - Lamp position: tilting

- **2075.713** HME 80W E27

Riflettore simmetrico - Symmetrical reflector

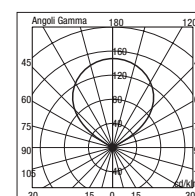
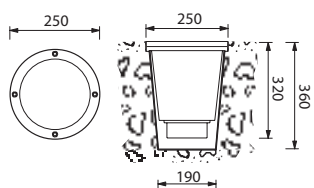

2075 71

GEO Ø310

Apparecchio da incasso a terra per esterni costituito da:

- Struttura in alluminio pressofuso
- Anello frontale in acciaio inox AISI 316 o in alluminio pressofuso
- Griglia frangiluce in alluminio pressofuso (a richiesta)
- Diffusore in vetro trasparente
- Riflettore in alluminio
- Guarnizioni in silicone
- Viti di chiusura in acciaio inox
- Controcassa in tecnopolimero
- Verniciatura in polveri poliestere ad elevata resistenza ai raggi ultravioletti e alla corrosione

Outdoor recessed ground luminaire constructed of:

- Painted die-cast aluminium structure
- Stainless steel AISI 316 or die-cast aluminium ring
- Die-cast aluminium diffuser grid (on request)
- Transparent glass diffuser
- Aluminium reflector
- Silicon gaskets
- Stainless steel screws
- Technopolymer holder
- Painting using high resistance to UV and corrosion polyester powders



Colori per copertura in alluminio
Colours for aluminium cover

- X=3 Nero
Black
- X=9 Antracite
Anthracite
- X=4 Silver

Diffusore - Diffuser
Codice-Code 00 1078
00 1478

Le lampadine vengono fornite solo su richiesta
Bulbs supplied only on request

Gli apparecchi vengono forniti completi di cassaforma
The holder is enclosed to the luminaire
Direttiva/Directive
EuP/ErP (2005/52/CE-2009/125/CE)
Gli apparecchi per lampade a scarica ad alta intensità sono progettati per lampade chiare e opali.
Luminaires for high intensity discharge lamps are designed for either clear and coated lamps.



Incasso a terra
Recessed ground version

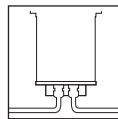

Doppia entrata cavi di alimentazione con presacavi PG13,5 (ø 6÷12 mm). Usare cavi flessibili per non compromettere la tenuta stagna IP67.
Double entrance of the supply cables with gland type PG 13,5(ø 6÷12 mm). Use only flexible cables to grant protection against water exposure (IP 67)

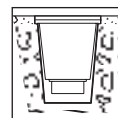

La cassaforma deve essere installata a filo terreno, prevedendo ghiaia di drenaggio per almeno 30 cm.
The holder must be recessed into the ground providing a drainage-gravel for at least 30 cm

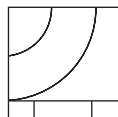

Carico massimo:
Kg 2000 a velocità max 30 Km/h
Maximum load:
Kg 2000 at 30/Km/h max speed



IK 09



CS 78
Controcassa in tecnopolimero
h 417 mm - Ø 290/230 mm
Technopolymer holder
h 417 mm - Ø 290/230 mm



ACCESSORIO: GR 78
Griglia frangiluce Silver
Silver diffuser grid
Ø 226 mm

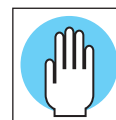

Simbolo che indica la temperatura superficiale sul vetro T<70°C (dati rilevati a ta per esterni di 15°C)
Glass surface temperature T<70°C (ambient temperature data of 15°C)

Temperatura calotta (ta 15°C) Cover's temperature (ta 15°C)			Zona di installazione: Intended usage:
HIT	35W	75°C	3/4
HIT	70W	103°C	1
HIT	150W	130°C	1
HIT-DE	150W	128°C	1

NOTA: zona di installazione definita dalla norma EN 60598-2-13 Allegato A - Vedi pag. 377
Note: intended usage is defined by the standard EN 60598-2-13 Annex A - See pag. 377

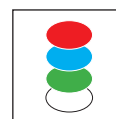

ACCESSORIO:
Negli apparecchi Geo Ø 310 è possibile inserire filtri dicroici colorati e filtri anticalorici. Non si possono mettere contemporaneamente filtri colorati e filtri anticalorici.

I filtri dicroici colorati e i filtri anticalorici vanno installati sotto il vetro di protezione utilizzando gli appositi anelli di sostegno forniti con gli stessi.

Cod. 7798
ROSSO/RED

Cod. 7797
BLU/BLUE

Cod. 7799
VERDE/GREEN

Cod. 7790
ANTICALORICO/
HEAT-DISSIPATING

Dichroic chromatic filters and heat-dissipating filters can be applied to the Geo Ø 275 luminaire. The chromatic and heat-dissipating filters can't be applied simultaneously.

The chromatic and heat-dissipating filters must be supplied under the safety glass diffuser, using the proper rings which are supplied with them.

L'utilizzo del filtro anticalorico è consentito solo per le versioni:
HIT 35W G12 - HIT 70W G12

Heat-dissipating filter can be applied only to the following versions:
HIT 35W G12 - HIT 70W G12

Anello frontale acciaio inox
Stainless steel bezel



1078

ANELLO INOX con sporgenza fuori terra inferiore a 5 mm
INOX RING with projection from the ground less than 5 mm

● **1078.350** HIT 35W G12

Riflettore simmetrico - Pos. lampadina basculante $\pm 15^\circ$
Symmetrical reflector - Lamp position: tilting $\pm 15^\circ$

● Con filtro anticalorico - With heat dissipating filter $T < 40^\circ\text{C}$

● **1078.770** HIT 70W G12

Riflettore simmetrico - Pos. lampadina basculante $\pm 15^\circ$
Symmetrical reflector - Lamp position: tilting $\pm 15^\circ$

● Con filtro anticalorico - With heat dissipating filter $T < 70^\circ\text{C}$

1078.750 HIT 150W G12

Riflettore simmetrico - Pos. lampadina basculante $\pm 15^\circ$
Symmetrical reflector - Lamp position: tilting $\pm 15^\circ$

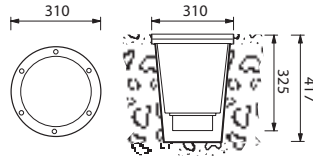

GEO Ø310

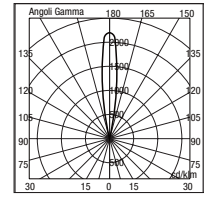

1078 75

GEO Ø310



1079

1079.720 HIT-DE 150W Rx7s

Riflettore asimmetrico - Asymmetrical reflector

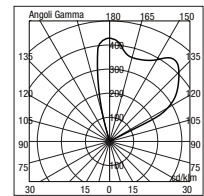
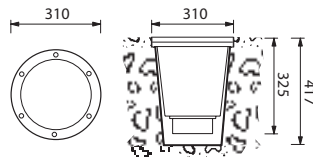

1079 72

Anello frontale in alluminio verniciato
Black die cast aluminium bezel

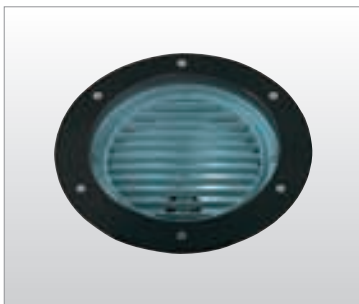

1478

ANELLO ALLUMINIO perfettamente a filo pavimento (sporgenza 0 mm)
in modo da non intralciare il camminamento

Perfectly flush with the floor ALUMINIUM RING (projection 0 mm)
as do not obstacle the walking

● **1478.35X** HIT 35W G12

Riflettore simmetrico - Pos. lampadina basculante $\pm 15^\circ$
Symmetrical reflector - Lamp position: tilting $\pm 15^\circ$

● Con filtro anticalorico - With heat dissipating filter $T < 40^\circ\text{C}$

● **1478.77X** HIT 70W G12

Riflettore simmetrico - Pos. lampadina basculante $\pm 15^\circ$
Symmetrical reflector - Lamp position: tilting $\pm 15^\circ$

● Con filtro anticalorico - With heat dissipating filter $T < 70^\circ\text{C}$

1478.75X HIT 150W G12

Riflettore simmetrico - Pos. lampadina basculante $\pm 15^\circ$
Symmetrical reflector - Lamp position: tilting $\pm 15^\circ$

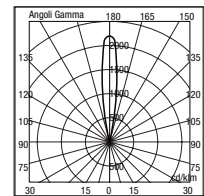
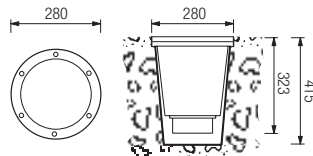

1478 75

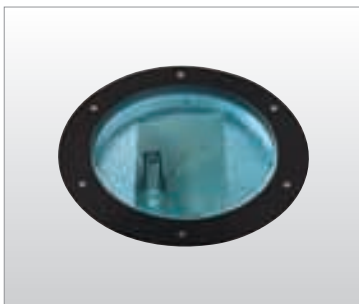

1479

1479.72X HIT-DE 150W Rx7s

Riflettore asimmetrico - Asymmetrical reflector

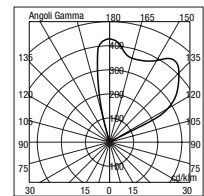
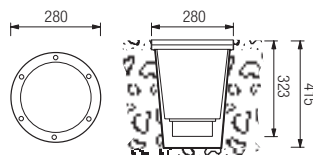

1479 72





HELIOS



HELIOS

Apparecchio da incasso a terra non calpestabile e non carrabile costituito da:

- Struttura in alluminio pressofuso
- Diffusore in vetro temperato trasparente
- Parabola riflettente in alluminio
- Guarnizioni in silicone
- Viti di chiusura in acciaio inox
- Pozzetto in polipropilene
- Verniciatura in polveri poliestere ad elevata resistenza ai raggi ultravioletti e alla corrosione

Not walkover and not driveover recessed ground luminaire constructed of:

- Die-cast aluminium structure
- Transparent tempered glass diffuser
- Aluminium reflector
- Silicon gaskets
- Stainless steel screws
- Polypropylene holder
- Painting using high resistance to UV and corrosion polyester powders



Colori - Colours

- X=2 Bianco White
 X=3 Nero Black
 X=9 Antracite Anthracite

Diffusore - Diffuser

Codice-Code 00 1050

Le lampadine vengono fornite solo su richiesta
 Bulbs supplied only on request

Gli apparecchi vengono forniti completi di cassaforma
 The holder is enclosed to the luminaire



Incasso a terra
 Recessed ground version

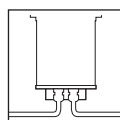

Doppia entrata cavi di alimentazione con presacavi PG13,5 (ø 6÷12 mm). Usare cavi flessibili per non compromettere la tenuta stagna IP67.
 Double entrance of the supply cables with gland type PG 13,5(ø 6÷12 mm). Use only flexible cables to grant protection against water exposure (IP 67)

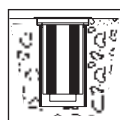

La cassaforma deve essere installata a filo terreno, prevedendo ghiaia di drenaggio per almeno 30 cm.
 The holder must be recessed into the ground providing a drainage-gravel for at least 30 cm

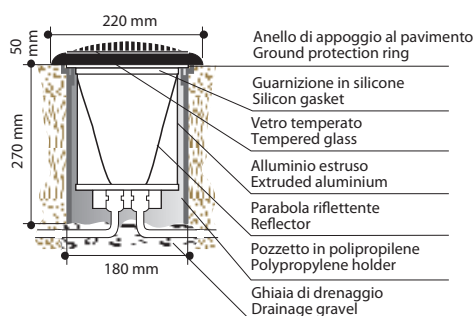
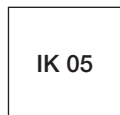

h 250 mm CS 51
 h 270 mm CS 18
 h 330 mm CS 71
 Pozzetto in polipropilene
 Ø 180 mm
 Polypropylene holder
 Ø 180 mm

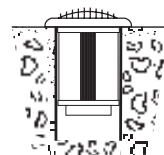

Simbolo che indica la temperatura superficiale sul vetro T<70°C (dati rilevati a ta per esterni di 15°C)
 Glass surface temperature T<70°C (ambient temperature data of 15°C)

Temperatura calotta (ta 15°C) Cover's temperature (ta 15°C)			Zona di installazione: Intended usage:
A60	100W	140°C	1
Q PAR30	75W	105°C	1
Q PAR38	80W	130°C	1
TC-T	18W	61°C	1
TC-T	26W	73°C	1
HME	80W	140°C	1
HIE/HSE	70W	130°C	1
QR111	75W	150°C	1
QT12	75W	150°C	1

NOTA: zona di installazione definita dalla norma EN 60598-2-13 Allegato A - Vedi pag. 377

Note: intended usage is defined by the standard EN 60598-2-13 Annex A - See pag. 377

Direttiva/Directive

EuP/ErP (2005/52/CE-2009/125/CE)

Gli apparecchi per lampade a scarica ad alta intensità sono progettati per lampade chiare e opali.

Luminaires for high intensity discharge lamps are designed for either clear and coated lamps.

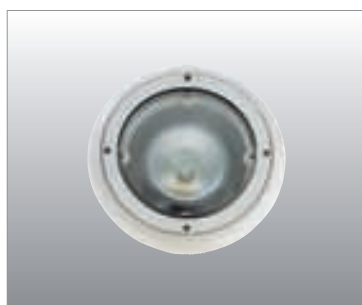

ANELLO/RING

ANELLO RING

1043.00X		A60	100W	E27
1051.00X		QPAR30	75W	E27
1055.00X basculante - tilting		QPAR30	75W	E27
1053.00X		QPAR38	80W	E27
1018.84X		TC-T	18W	GX24 d-2
1026.83X		TC-T	26W	GX24 d-3
1041.71X		HME	80W	E27
1047.73X		HIE	70W	E27
1047.74X		HSE	70W	E27
1014.07X basculante - tilting		QR111	75W	G53
1049.12X basculante - tilting		QT12	75W	GY 6.35

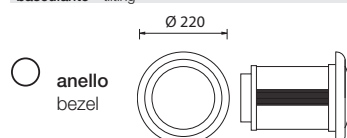

GRIGLIA GRID

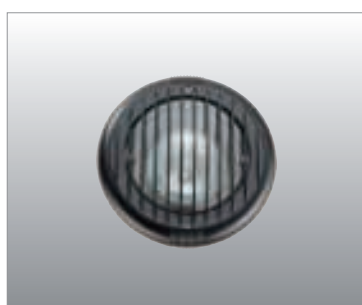

GRIGLIA/GRID

1042.00X		A60	100W	E27
1050.00X		QPAR30	75W	E27
1054.00X basculante - tilting		QPAR30	75W	E27
1052.00X		QPAR38	80W	E27
1019.84X		TC-T	18W	GX24 d-2
1027.83X		TC-T	26W	GX24 d-3
1040.71X		HME	80W	E27
1046.73X		HIE	70W	E27
1046.74X		HSE	70W	E27
1012.07X basculante - tilting		QR111	75W	G53
1048.12X basculante - tilting		QT12	75W	GY 6.35

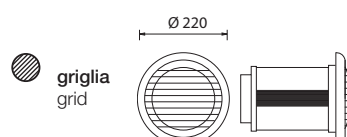



CARATTERISTICHE - CHARACTERISTICS

HELIOS

HELIOS

Cod. 1014.07X

$\eta = 100\%$ cd / 1000 lm

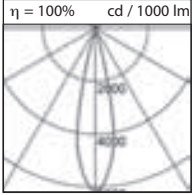

CO-C180
23°

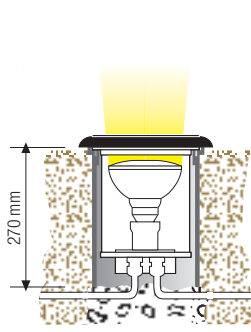

PAR 38 80W

Cod. ● 1052 ○ 1053

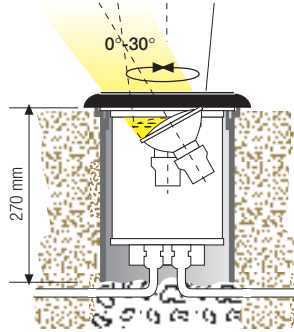

PAR 30 75W

Cod. ● 1054 ○ 1055
Basculante / Tilting

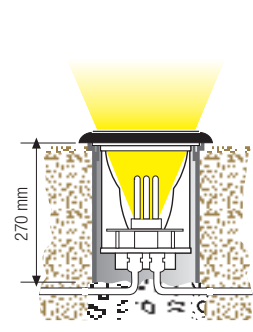

TC-T 18W

Cod. ● 1019 ○ 1018

Cod. 1019.84X

$\eta = 24.6\%$ cd / 1000 lm

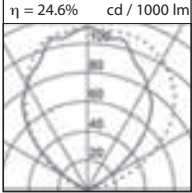

CO / C180 / C90 / C270
-/-/-

Cod. 1026.83X

$\eta = 49.3\%$ cd / 1000 lm

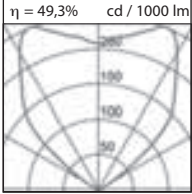

CO-C180

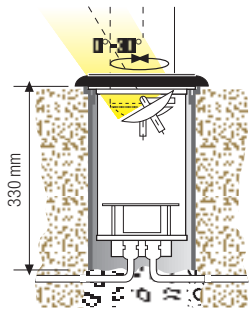

QR111 75W

Cod. ● 1012 ○ 1014
Basculante / Tilting

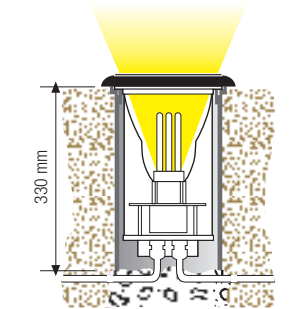

TC-T 26W

Cod. ● 1027 ○ 1026

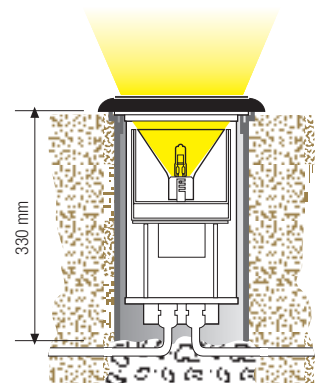

QT12 75W

Cod. ● 1048 ○ 1049
Basculante / Tilting

Cod. 1027.83X

$\eta = 24.6\%$ cd / 1000 lm

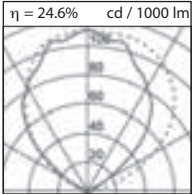

CO / C180 / C90 / C270
-/-/-

Cod. 1040.71X

$\eta = 49.3\%$ cd / 1000 lm

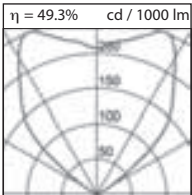

CO-C180

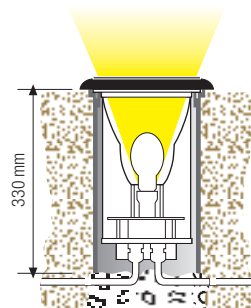

HME 80W

Cod. ● 1040 ○ 1041
HIE/HSE 70W

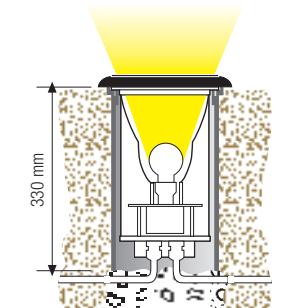

A60 100W

Cod. ● 1042 ○ 1043

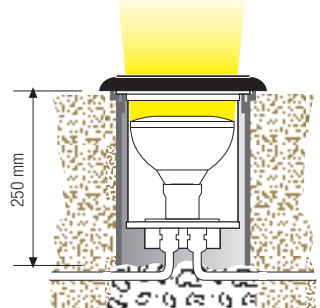

PAR 30 75W

Cod. ● 1050 ○ 1051

Cod. 1042.00X

$\eta = 24.6\%$ cd / 1000 lm

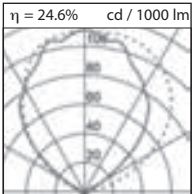

CO / C180 / C90 / C270
-/-/-

○ anello
bezel ● griglia
grid

Cod. 1046.73X

$\eta = 51.3\%$ cd / 1000 lm

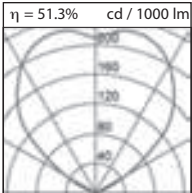

CO-C180

Cod. 1050.00X

$\eta = 100\%$ cd / 1000 lm

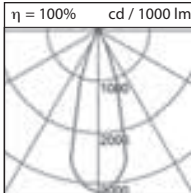

CO-C180
27.5°

Cod. 1051.00X

$\eta = 100\%$ cd / 1000 lm

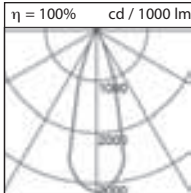

CO-C180
27.5°

Cod. 1018.84X

$\eta = 49.3\%$ cd / 1000 lm

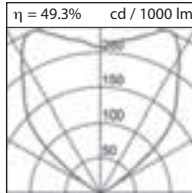

CO-C180

Cod. 1043.00X

$\eta = 49.3\%$ cd / 1000 lm

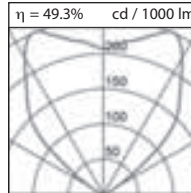

CO-C180

Cod. 1041.71X

$\eta = 49.3\%$ cd / 1000 lm

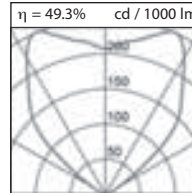

CO-C180

HELIOS WALL

Apparecchio da incasso a parete costituito da:

- Struttura in alluminio pressofuso
- Diffusore in vetro temperato satinato
- Parabola riflettente in alluminio
- Guarnizioni in silicone
- Viti di chiusura in acciaio inox
- Pozzetto in tecnopolimero
- Verniciatura in polveri poliesteri ad elevata resistenza ai raggi ultravioletti e alla corrosione

Recessed ground luminaire constructed of:

- Die-cast aluminium structure
- Satin tempered glass diffuser
- Aluminium reflector
- Silicon gaskets
- Stainless steel screws
- Technopolymer holder
- Painting using high resistance to UV and corrosion polyester powders



Colori - Colours

X=2  Bianco
White

X=3  Nero
Black

X=9  Antracite
Anthracite

Diffusore - Diffuser

Codice-Code 00 1020

per/for Cod. 1020 - 1021 - 1022
1030 - 1031 - 1032

Codice-Code 00 1023

per/for Cod. 1023 - 1033

Le lampadine vengono fornite solo su richiesta

Bulbs supplied only on request

Gli apparecchi vengono forniti completi di cassaforma

The holder is enclosed to the luminaire

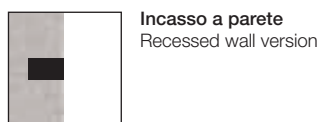

Incasso a parete
Recessed wall version

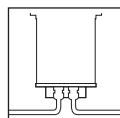

Doppia entrata cavi di alimentazione con presacavi PG13,5 (ø 6÷12 mm). Usare cavi flessibili per non compromettere la tenuta stagna IP67.
Double entrance of the supply cables with gland type PG 13,5(ø 6÷12 mm). Use only flexible cables to grant protection against water exposure (IP 67)

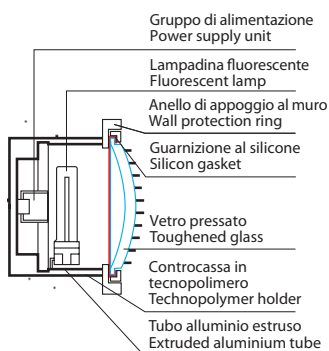
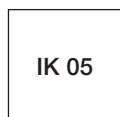

La cassaforma deve essere installata a filo muro.
Holder must be recessed flush with the wall surface



CS 20
Controcassa in tecnopolimero da incassare nel muro prima dell'installazione della lampada Ø 185 mm - h. 100 mm. Non può essere installata a pavimento.

Technopolymer holder to be recessed into the wall before the installation of the luminaire Ø 185 mm - h. 100 mm. Not to be fitted as a buried uplighter.

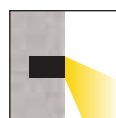

Per/for Cod. 1023 - 1033
L'emissione di luce verso il basso è nel pieno rispetto delle leggi contro l'inquinamento luminoso.

The direct light emission is in full compliance with standard light pollution directives

HELIOS WALL

HELIOS WALL



1030

1030.00X		C35	40W	E14
1030.92X		TC-D	10W	G24 d-1

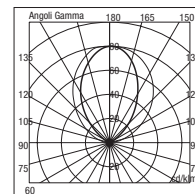
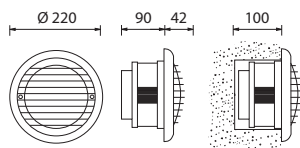

1030 92

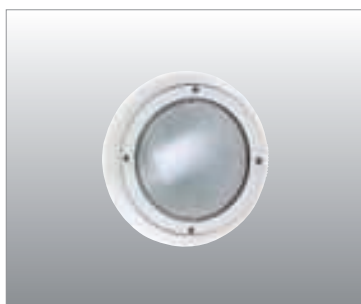

1031

1031.00X		C35	40W	E14
1031.92X		TC-D	10W	G24 d-1

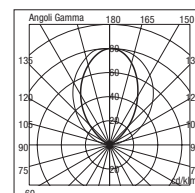
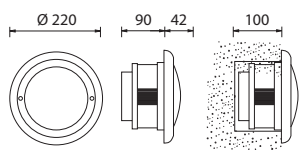

1031 92

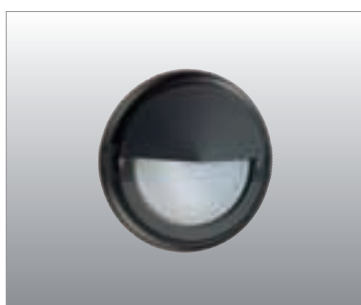

1032

1032.00X		C35	40W	E14
1032.92X		TC-D	10W	G24 d-1

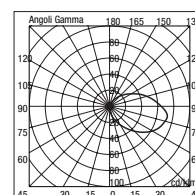
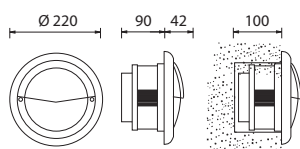



1032 92

HELIOS WALL

HELIOS WALL



1020

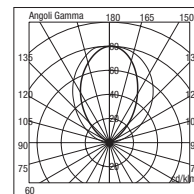
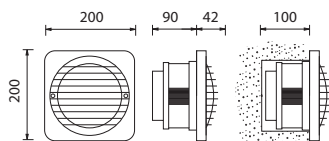

1020.00X		C35	40W	E14
1020.92X		TC-D	10W	G24 d-1

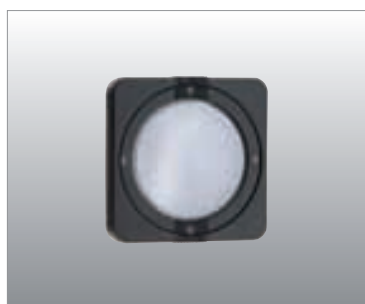

1020 92



1021

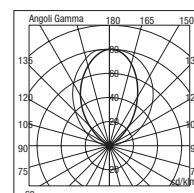
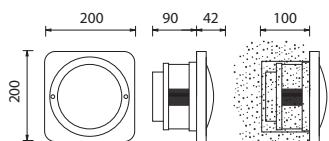

1021.00X		C35	40W	E14
1021.92X		TC-D	10W	G24 d-1

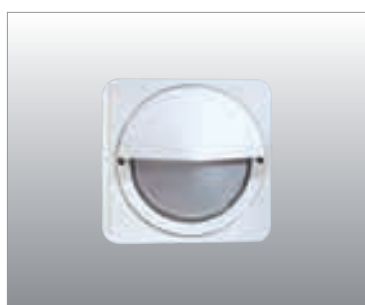

1021 92



1022

1022.00X		C35	40W	E14
1022.92X		TC-D	10W	G24 d-1

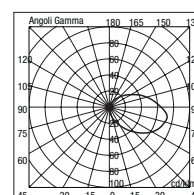
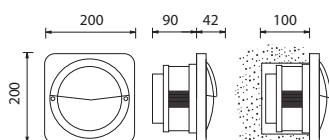

1022 92

HELIOS WALL

HELIOS WALL

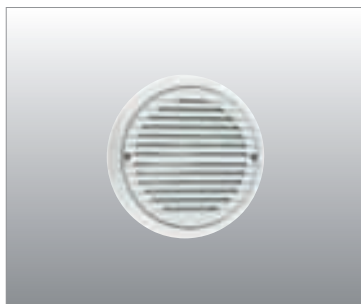

1033

1033.00X		C35	40W	E14
1033.92X		TC-D	10W	G24 d-1

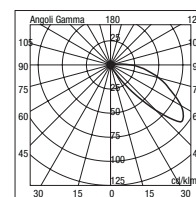
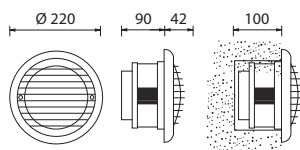

1033 92

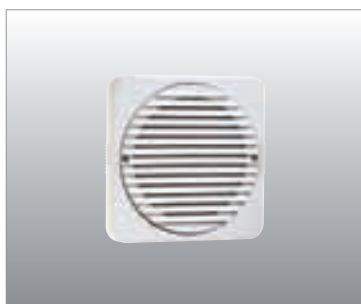

1023

1023.00X		C35	40W	E14
1023.92X		TC-D	10W	G24 d-1

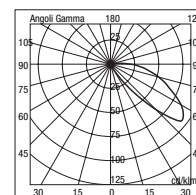
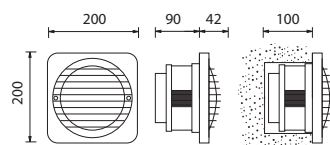

1023 92

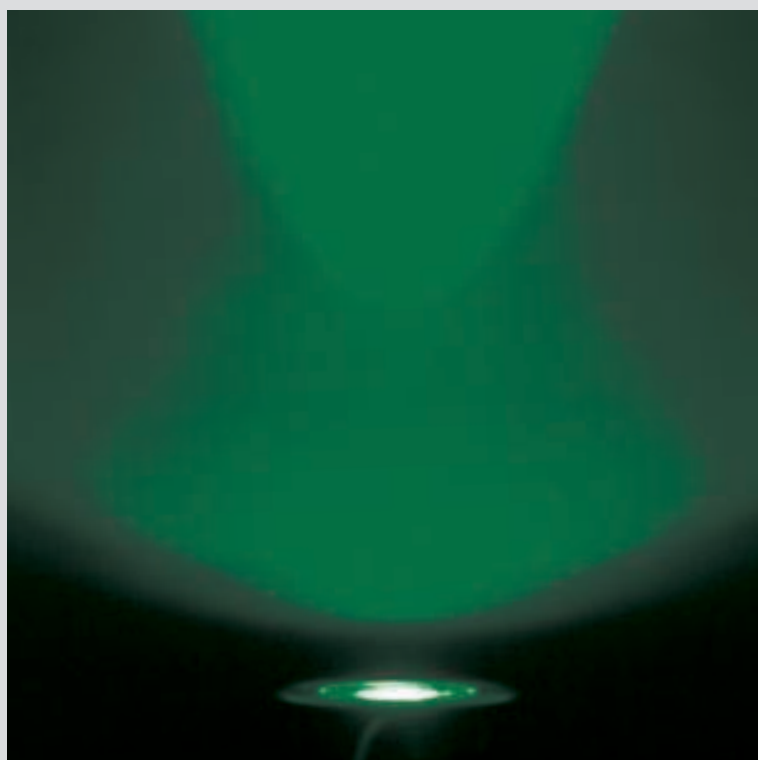



ADAS

ADAS

Apparecchio da incasso a parete e a terra costituito da:

- Struttura in alluminio pressofuso
- Copertura in acciaio inox satinato
- Diffusore in vetro temperato trasparente
- Parabola riflettente in alluminio
- Guarnizioni in silicone
- Viti di chiusura in acciaio inox
- Controcassa in tecnopolimero per Cod. 1085
- Pozzetto in polipropilene per Cod. 1084
- Verniciatura in polveri poliestere ad elevata resistenza ai raggi ultravioletti e alla corrosione

Outdoor recessed wall or ground luminaire constructed of:

- Die-cast aluminium structure
- Satin stainless steel bezel
- Transparent tempered glass diffuser
- Aluminium reflector
- Silicon gaskets
- Stainless steel screws
- Technopolymer holder for Code 1085
- Polypropylene holder for Code 1084
- Painting using high resistance to UV and corrosion polyester powders



Diffusore - Diffuser

Codice-Code 00 1085

Le lampadine vengono fornite solo su richiesta
Bulbs supplied only on request

Gli apparecchi vengono forniti completi di cassaforma
The holder is enclosed to the luminaire

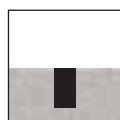

Cod. 1084
Incasso a terra
Recessed ground version

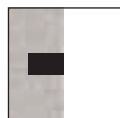

Cod. 1085
Incasso a parete
Recessed wall version

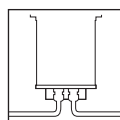

Doppia entrata cavi di alimentazione con presacavi PG13,5 (ø 6÷12 mm). Usare cavi flessibili per non compromettere la tenuta stagna IP67.
Double entrance of the supply cables with gland type PG 13,5(ø 6÷12 mm). Use only flexible cables to grant protection against water exposure (IP 67)



Versione terra. La cassaforma deve essere installata a filo terreno, prevedendo ghiaia di drenaggio per almeno 30 cm.
Recessed ground luminaire.
The holder must be recessed into the ground providing a drainage-gravel for at least 30 cm



Versione muro. La cassaforma deve essere installata a filo muro.
Wall version. Holder must be recessed flush with the wall surface

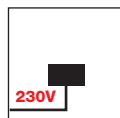

LED - art. 1085.880 - 1084.880
Led a tensione di rete 220/240V 50Hz.
Connessione diretta alla rete di alimentazione senza necessità di trasformatore.
LED's direct operation at 220/240V 50Hz.
No transformer is required.

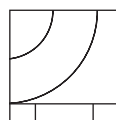

Carico massimo:
Kg 2000 a velocità max 10 Km/h
Maximum load:
Kg 2000 at 10/Km/h max speed



Simbolo che indica la temperatura superficiale sul vetro T<70°C (dati rilevati a ta di 15°C)
Glass surface temperature T<70°C (ambient temperature data of 15°C)

Temperatura calotta (ta 15°C)			Zona di installazione:
Cover's temperature (ta 15°C)			Intended usage:
C35	60W	75°C	4
TC-D	10W	40°C	5
1 LED	4,1W	<40°C	5

NOTA: zona di installazione definita dalla norma EN 60598-2-13 Allegato A - Vedi pag. 377
Note: intended usage is defined by the standard EN 60598-2-13 Annex A - See pag. 377



CS 1084 per/for Cod. 1084
Pozzetto in polipropilene
Polypropylene holder
Ø 180 mm - h 180 mm



CS 1085 per/for Cod. 1085
Controcassa in tecnopolimero da incassare a filo muro prima dell'installazione della lampada
Ø 185 mm - h. 130 mm.
Non può essere installata a pavimento.
Technopolymer holder to be recessed into the wall before the installation of the luminaire
Ø 185 mm - h. 130 mm.
Not to be fitted as a buried uplighter.



1085

Apparecchio da incasso a parete
Recessed wall luminaire

1085.000		C35	40W	E14
1085.920		TC-D	10W	G24 d-1
1085.880		1LED bianco/white	4,1W	230 lm 6300 K

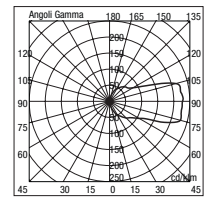
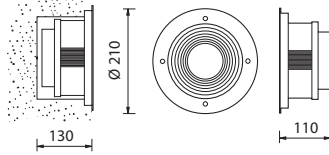



1085 00



1084

Apparecchio da incasso a terra
Ground recessed luminaire

1084.000		C35	60W	E14
1084.920		TC-D	10W	G24 d-1
1084.880		1LED bianco/white	4,1W	230 lm 6300 K

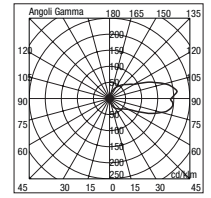
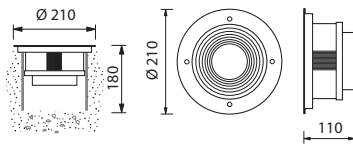

1084 92



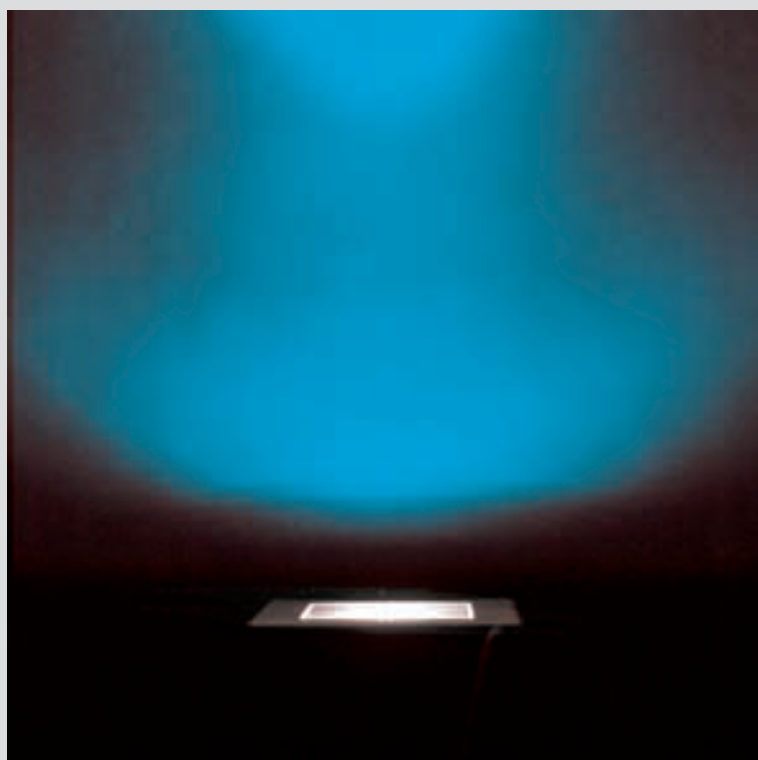



QUAD

MICRO QUAD

Apparecchio da incasso a terra e a parete per esterni ed interni costituito da:

- Corpo in alluminio pressofuso verniciato
- Anello frontale in acciaio inox AISI 316
- Diffusore in vetro satinato temperato
- Guarnizione in silicone
- Viti di chiusura in acciaio inox
- Controcassa in tecnopolimero
- Verniciatura in polveri poliestere ad elevata resistenza ai raggi ultravioletti e alla corrosione

Outdoor and indoor recessed ground and wall luminaire constructed of:

- Painted die-cast aluminium body
- Stainless steel AISI 316 ring
- Satin tempered glass diffuser
- Silicon gasket
- Stainless steel screws
- Technopolymer holder
- Painting using high resistance to UV and corrosion polyester powders



Colori 1 Led - 1 Led Colours



Diffusore - Diffuser

Codice-Code 00 5074

Le lampadine vengono fornite solo su richiesta

Bulbs supplied only on request

Gli apparecchi vengono forniti completi di cassaforma

The holder is enclosed to the luminaire

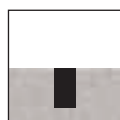

Incasso a terra
Recessed ground version

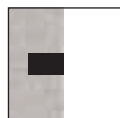

Incasso a parete
Recessed wall version

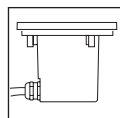

Entrata singola cavi di alimentazione con pressacavi PG 7 (Ø 3,5÷7 mm). Usare cavi flessibili. (Cavi rigidi possono compromettere la tenuta stagna IP67).

Single power supply entry cable with PG 7 (Ø 3,5÷7 mm) cable glands. Use flexible cables (rigid cables may compromise IP 67 rating)

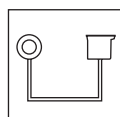

5074.530
L'apparecchio necessita di trasformatore remoto 230V/12V posizionato all'inizio della linea di alimentazione.
The transformer (230V-12V) for low voltage must be installed in the remote position

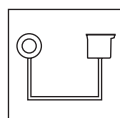

5094 LED
L'apparecchio necessita di alimentatore remoto elettronico 12-24V dc.
The luminaire needs a remote power supplier 12-24V dc.

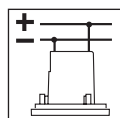

Connessione in parallelo.
Parallel connection.

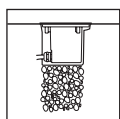

La cassaforma deve essere installata a filo terreno, prevedendo ghiaia di drenaggio per almeno 30 cm.

Ground luminaire. The holder must be recessed into the ground providing a drainage-gravel for at least 30 cm



CS 44
Cassaforma in tecnopolimero per vano ad incasso h 94 mm - 114 x 85 mm - □ 64 mm
Technopolymer holder to be recessed h 94 mm - 114 x 85 mm - □ 64 mm

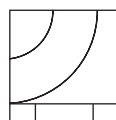

Carico massimo:
Kg 2000 a velocità max 30 Km/h
Maximum load:
Kg 2000 at 30/Km/h max speed



Simbolo che indica la temperatura superficiale sul vetro T<70°C (dati rilevati a ta di 15°C)
Glass surface temperature T<70°C (ambient temperature data of 15°C)

Temperatura calotta (ta 15°C)		Zona di installazione:	
Cover's temperature (ta 15°C)		Intended usage:	
1 LED	1,1W	<40°C	5
QR-CBC 35	10W	60°C	3/4

NOTA: zona di installazione definita dalla norma EN 60598-2-13 Allegato A - Vedi pag. 377
Note: intended usage is defined by the standard EN 60598-2-13 Annex A - See pag. 377

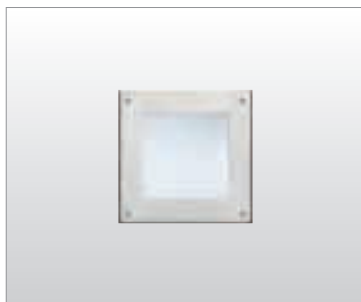

5074 LED

5074.010 1LED bianco/white max 1,1W 12-24V dc 100 lm 6300 K

Con trasformatore remoto (non fornito) / Remote transformer (not supplied)

5074.020 1LED blu/blue max 1,1W 12-24V dc 40 lm

Con trasformatore remoto (non fornito) / Remote transformer (not supplied)

5074.030 1LED rosso/red max 1,1W 12-24V dc 50 lm

Con trasformatore remoto (non fornito) / Remote transformer (not supplied)

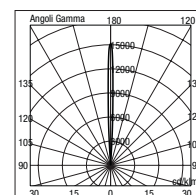
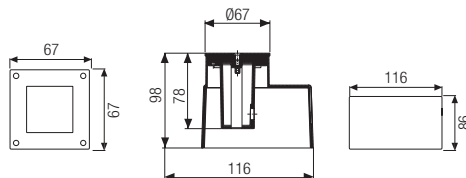

5074 01

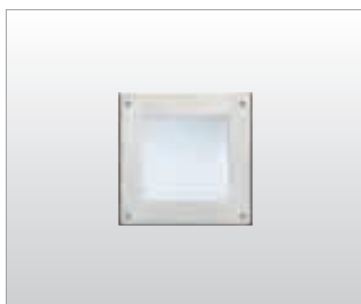

5074

5074.530  QR-CBC35 10W GU4 12V

Con trasformatore remoto (non fornito) / Remote transformer (not supplied)

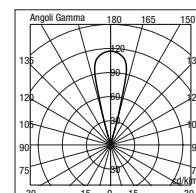
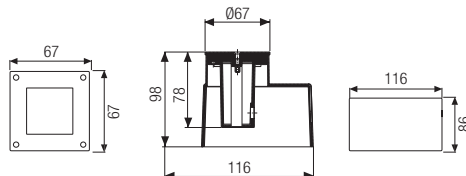

5074 53

QUAD 125

Apparecchio da incasso a parete e a terra per interni ed esterni costituito da:

- Struttura in alluminio pressofuso verniciato
- Anello in acciaio inox AISI 316 o in alluminio pressofuso
- Diffusore in vetro satinato
- Riflettore in alluminio
- Guarnizioni in silicone
- Viti di chiusura in acciaio inox
- Controcassa in tecnopolimero
- Verniciatura in polveri poliestere ad elevata resistenza ai raggi ultravioletti e alla corrosione

Outdoor and indoor wall and recessed ground luminaire constructed of:

- Painted die-cast aluminium structure
- Stainless steel AISI 316 or die cast aluminium ring
- Satin glass diffuser
- Aluminium reflector
- Silicon gaskets
- Stainless steel screws
- Technopolymer holder
- Painting using high resistance to UV and corrosion polyester powders



Colori - Colours per/for 5070

- X=2 Bianco White
- X=3 Nero Black
- X=9 Antracite Anthracite
- X=4 Silver

Diffusore - Diffuser

Codice-Code 00 5070

Le lampadine vengono fornite solo su richiesta ad eccezione della versione T2 6W e 60 LED
Bulbs supplied only on request except for T2 6W and 60 LED version

Gli apparecchi vengono forniti completi di cassaforma
The holder is enclosed to the luminaire

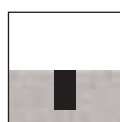

Incasso a terra
Recessed ground version

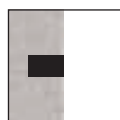

Incasso a parete
Recessed wall version

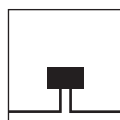

Doppia entrata cavi di alimentazione con pressacavi M16 (Ø 5x10 mm). Usare cavi flessibili. (Cavi rigidi possono compromettere la tenuta stagna IP67).
Double power supply entry cable with M16 cable glands. Use flexible cables (rigid cables may compromise IP 67 rating)

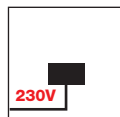

LED
Led a tensione di rete 220/240V 50Hz.
Connessione diretta alla rete di alimentazione senza necessità di trasformatore.
LED's direct operation at 220/240V 50Hz.
No transformer is required.

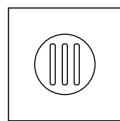

Fluorescente 6W-Gx53
Non necessita di alcun alimentatore.
Fluorescent lamp 6W-Gx53
Does not need the power supplier

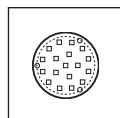

60 LED Gx53
Non necessita di alcun alimentatore.
60 LED Gx53
Does not need the power supplier

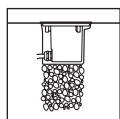

Apparecchio versione terra.
La cassaforma deve essere installata a filo terreno, prevedendo ghiaia di drenaggio per almeno 30 cm.
Ground luminaire. The holder must be recessed into the ground providing a drainage-gravel for at least 30 cm



Versione muro.
La cassaforma deve essere installata a filo muro.
Wall version.
Holder must be recessed flush with the wall surface



CS 72
Cassaforma in tecnopolimero
Technopolymer holder
118 mm - h 125 mm

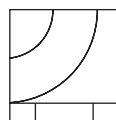

Carico massimo:
Kg 2000 a velocità max 30 Km/h
Maximum load:
Kg 2000 at 30/Km/h max speed



IK 07



Simbolo che indica la temperatura superficiale sul vetro T<70°C (dati rilevati a ta di 15°C)
Glass surface temperature T<70°C (ambient temperature data of 15°C)

Temperatura calotta (ta 15°C)			Zona di installazione: Intended usage:
Cover's temperature (ta 15°C)			
QT14	40W	130°C	1
Q PAR16	35W	170°C	1
60 LED	4W	<40°C	5
T2	6W	<40°C	5
1 LED	4,1W	<40°C	5

NOTA: zona di installazione definita dalla norma EN 60598-2-13 Allegato A - Vedi pag. 377
Note: intended usage is defined by the standard EN 60598-2-13 Annex A - See pag. 377

QUAD 125

QUAD 125



5072

Copertura in acciaio inox

Stainless steel cover

5072.140		QT14 Halopin	40W	G9		
5072.150		Q PAR16	35W	GU10		
• 5072.600		T2	6W	Gx53		
• 5072.680		60LED bianco/white	4W	Gx53	260 lm	4000 K
5072.880		1LED bianco/white	4,1W		230 lm	6300 K

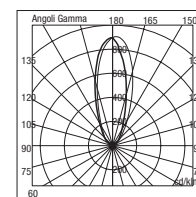
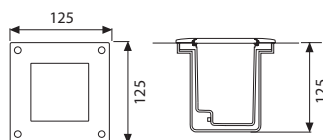

5072 15



5070

Copertura in alluminio

Die-cast aluminium cover

5070.14X		QT14 Halopin	40W	G9		
5070.15X		Q PAR16	35W	GU10		
• 5070.60X		T2	6W	Gx53		
• 5070.68X		60LED bianco/white	4W	Gx53	260 lm	4000 K
5070.88X		1LED bianco/white	4,1W		230 lm	6300 K

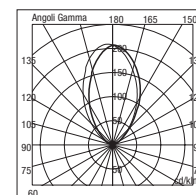
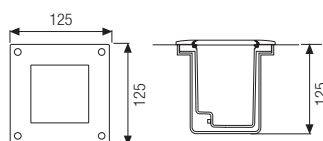

5070 14

- L'apparecchio viene fornito completo di lampadina
Bulb enclosed to the luminaire

QUAD 163

Apparecchio da incasso a terra per esterni costituito da:

- Struttura in alluminio pressofuso
- Anello frontale in acciaio inox AISI 316 o in alluminio pressofuso
- Diffusore in vetro trasparente
- Riflettore in alluminio
- Guarnizioni in silicone
- Viti di chiusura in acciaio inox
- Pozzetto in tecnopolimero
- Verniciatura in polveri poliestere ad elevata resistenza ai raggi ultravioletti e alla corrosione

Outdoor recessed ground luminaire constructed of:

- Painted die-cast aluminium structure
- Stainless steel AISI 316 or die-cast aluminium ring
- Transparent glass diffuser
- Aluminium reflector
- Silicon gaskets
- Stainless steel screws
- Technopolymer holder
- Painting using high resistance to UV and corrosion polyester powders



Colori - Colours

- X=3** Nero
Black
- X=9** Antracite
Anthracite
- X=4** Silver

Diffusore - Diffuser

Codice-Code 00 5092

Le lampadine vengono fornite solo su richiesta
Bulbs supplied only on request

Gli apparecchi vengono forniti completi di cassaforma
The holder is enclosed to the luminaire

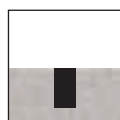

Incasso a terra
Recessed ground version

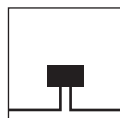

Doppia entrata cavi di alimentazione con presacavi M16 (Ø 5÷10 mm). Usare cavi flessibili. (Cavi rigidi possono compromettere la tenuta stagna IP67).
Double power supply entry cable with M16 cable glands. Use flexible cables (rigid cables may compromise IP 67 rating)

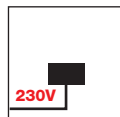

LED - art. 5092.880 - 5093.88X
Led a tensione di rete 220/240V 50Hz.
Connessione diretta alla rete di alimentazione senza necessità di trasformatore.
LED's direct operation at 220/240V 50Hz.
No transformer is required.

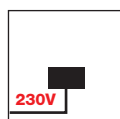

3 LED
L'apparecchio è fornito completo di alimentatore elettronico Full Range 100/240V 50/60Hz posizionato all'interno dell'apparecchio.
The luminaire is supplied with a Full Range 100/240V 50/60Hz built-in transformer

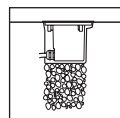

Apparecchio versione terra. La cassaforma deve essere installata a filo terreno, prevedendo ghiaia di drenaggio per almeno 30 cm.
Ground luminaire. The holder must be recessed into the ground providing a drainage-gravel for at least 30 cm



CS 92
Cassaforma in tecnopolimero
Technopolymer holder
158 mm - h 210 mm

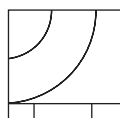

Carico massimo:
Kg 2000 a velocità max 30 Km/h
Maximum load:
Kg 2000 at 30/Km/h max speed



IK 09



Simbolo che indica la temperatura superficiale sul vetro T<70°C (dati rilevati a ta di 15°C)
Glass surface temperature T<70°C (ambient temperature data of 15°C)

Temperatura calotta (ta 15°C)
Cover's temperature (ta 15°C)

Zona di installazione:
Intended usage:

Q PAR 20	50W	145°C	1
Q PAR 16	40W	145°C	1
1 LED	4,1W	<40°C	5
3 LED	9W	<40°C	5

NOTA: zona di installazione definita dalla norma EN 60598-2-13 Allegato A - Vedi pag. 377
Note: intended usage is defined by the standard EN 60598-2-13 Annex A - See pag. 377

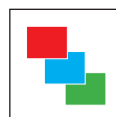

FILTRI COLORATI
Negli apparecchi Quad 163 è possibile inserire filtri dicroici colorati per ottenere effetti suggestivi.

Cod. 7768
ROSSO/RED

CHROMATIC FILTERS
Chromatic filters can be applied to the Quad 163 luminaire, thus creating scenographic effects and dreaming atmospheres.

Cod. 7767
BLU/BLUE

Cod. 7769
VERDE/GREEN



5092

Copertura in alluminio
Die-cast aluminium cover

5092.000 Q PAR20 50W E27

Pos. lampadina fissa / Lamp position: not tilting

5092.150 Q PAR16 40W E14

Pos. lampadina basculante $\pm 30^\circ$ / Lamp position: tilting $\pm 30^\circ$

5092.880 1LED bianco/white 4,1W 230 lm 6300 K

Modulo da 3 LED orientabile $\pm 30^\circ$ con lente 20/25°
3 LED adjustable module $\pm 30^\circ$ with 20/25° lens

5092.660 3LED bianco/white 9W 500 lm 6300 K

Con alimentatore elettronico incorporato / Built-in electronic power supplier

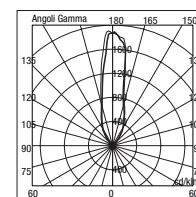
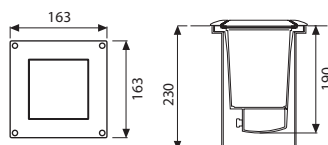

5092 00

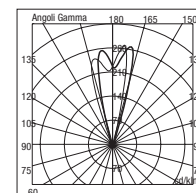

5092 66

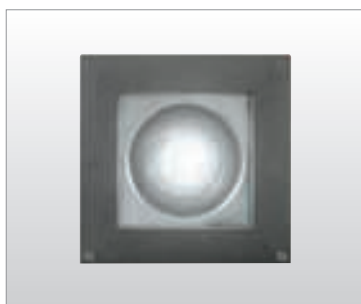

5093

Copertura in alluminio
Die-cast aluminium cover

5093.00X Q PAR20 50W E27

Pos. lampadina fissa / Lamp position: not tilting

5093.15X Q PAR16 40W E14

Pos. lampadina basculante $\pm 30^\circ$ / Lamp position: tilting $\pm 30^\circ$

5093.88X 1LED bianco/white 4,1W 230 lm 6300 K

Modulo da 3 LED orientabile $\pm 30^\circ$ con lente 20/25°
3 LED adjustable module $\pm 30^\circ$ with 20/25° lens

5093.66X 3LED bianco/white 9W 500 lm 6300 K

Con alimentatore elettronico incorporato / Built-in electronic power supplier

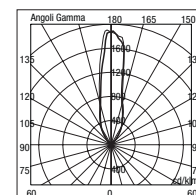
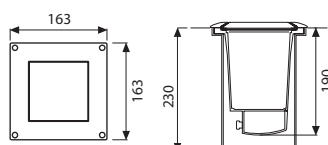

5093 00

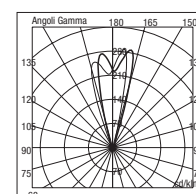

5093 66

QUAD 200

Apparecchio da incasso a terra per esterni costituito da:

- Struttura in alluminio pressofuso
- Anello frontale in acciaio inox AISI 316 o in alluminio pressofuso
- Diffusore in vetro trasparente
- Riflettore in alluminio
- Guarnizioni in silicone
- Viti di chiusura in acciaio inox
- Pozzetto in tecnopolimero
- Verniciatura in polveri poliestere ad elevata resistenza ai raggi ultravioletti e alla corrosione

Outdoor recessed ground luminaire constructed of:

- Painted die-cast aluminium structure
- Stainless steel AISI 316 or die-cast aluminium ring
- Transparent glass diffuser
- Aluminium reflector
- Silicon gaskets
- Stainless steel screws
- Technopolymer holder
- Painting using high resistance to UV and corrosion polyester powders

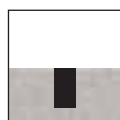

Incasso a terra
Recessed ground version

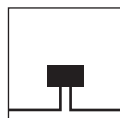

Entrata doppia cavi di alimentazione con pressacavi PG 13,5 (Ø 6÷12 mm). Usare cavi flessibili. (Cavi rigidi possono compromettere la tenuta stagna IP67).

Double power supply entry cables with PG 13,5 (Ø 6÷12 mm) cable glands. Use flexible cables (rigid cables may compromise IP 67 rating)

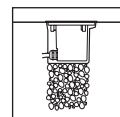

La cassaforma deve essere installata a filo terreno, prevedendo ghiaia di drenaggio per almeno 30 cm.

Ground luminaire. The holder must be recessed into the ground providing a drainage-gravel for at least 30 cm



CS 95
Cassaforma in tecnopolimero
Technopolymer holder
h 360 mm - ∅ 220/250 mm

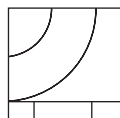

Carico massimo:
Kg 2000 a velocità max 30 Km/h
Maximum load:
Kg 2000 at 30/Km/h max speed

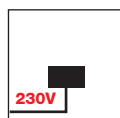

LED - art. 7030.880 - 7230.880 - 7430.880
Led a tensione di rete 220/240V 50Hz.
Connessione diretta alla rete di alimentazione senza necessità di trasformatore.
LED's operation at 220/240V 50Hz voltage directly. No transformer is required.



IK 09



Simbolo che indica la temperatura superficiale sul vetro <70°C (dati rilevati a ta di 15°C)
Glass surface temperature <70°C (ambient temperature data of 15°C)

Temperatura calotta (ta 15°C)
Cover's temperature (ta 15°C)

Zona di installazione:
Intended usage:

HIT	35W	94°C	2
HIT	70W	105°C	1
HIT-DE	70W	110°C	1
TC-T	26W	62°C	3/4
4LED	16,4W	<50°C	4/5

NOTA: zona di installazione definita dalla norma EN 60598-2-13 Allegato A - Vedi pag. 377
Note: intended usage is defined by the standard EN 60598-2-13 Annex A - See pag. 377

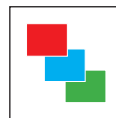

Negli apparecchi Quad è possibile inserire filtri dicroici colorati e filtri anticalorici. Non si possono mettere contemporaneamente filtri colorati e filtri anticalorici.

I filtri dicroici colorati e i filtri anticalorici vanno installati sotto il vetro di protezione utilizzando gli appositi anelli di sostegno forniti con gli stessi.

Cod. 7738
ROSSO/RED

Cod. 7737
BLU/BLUE

Cod. 7739
VERDE/GREEN

Cod. 7730
ANTICALORICO/
HEAT-DISSIPATING

Dichroic chromatic filters and heat-dissipating filters can be applied to the Quad luminaires. The chromatic and heat-dissipating filters can't be applied simultaneously.

The chromatic and heat-dissipating filters must be supplied under the safety glass diffuser, using the apposite rings which are supplied with them.

L'utilizzo del filtro anticalorico è consentito solo per le versioni:
HIT 35W G12 - TC-T 26W

Heat-dissipating filter can be applied only to the following versions:
HIT 35W G12 - TC-T 26W



Colori - Colours

Per/for Cod. 7430 - 7431 - 7433 - 7436

X=3 Nero
Black

X=9 Antracite
Anthracite

X=4 Silver

Diffusore - Diffuser

Codice-Code 00 7030
00 7430

Le lampadine vengono fornite solo su richiesta
Bulbs supplied only on request

Gli apparecchi vengono forniti completi di cassaforma
The holder is enclosed to the luminaire

Direttiva/Directive EuP/ErP (2005/52/CE-2009/125/CE)
Gli apparecchi per lampade a scarica ad alta intensità sono progettati per lampade chiare e opali.
Luminaires for high intensity discharge lamps are designed for either clear and coated lamps.

ANELLO INOX perfettamente a filo pavimento (sporgenza 0 mm)
 in modo da non intralciare il camminamento
*Perfectly flush with the floor INOX RING (projection 0 mm)
 as do not obstacle the walking*

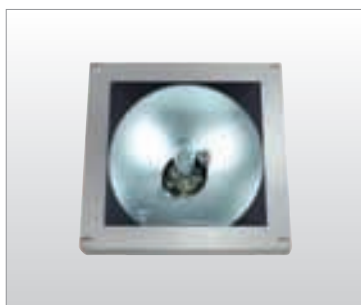

7030

- **7030.350** HIT 35W G12
 Riflettore simmetrico - Pos. lampadina basculante $\pm 15^\circ$
 Symmetrical reflector - Lamp position: tilting $\pm 15^\circ$
- Con filtro anticalorico - With heat dissipating filter T < 70°C
- **7030.770** HIT 70W G12
 Riflettore simmetrico - Pos. lampadina basculante $\pm 15^\circ$
 Symmetrical reflector - Lamp position: tilting $\pm 15^\circ$
- **7030.880** 4LED bianco/white 16,4W 920 lm 6300 K

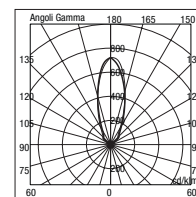
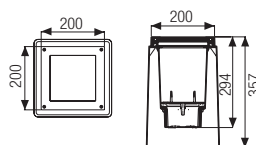

7030 77



7031

- **7031.780** HIT-DE 70W Rx7s
 Riflettore asimmetrico - Asymmetrical reflector

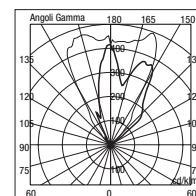
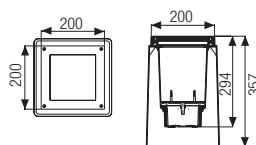

7031 78



7033

- **7033.780** HIT-DE 70W Rx7s
 Riflettore simmetrico - Symmetrical reflector

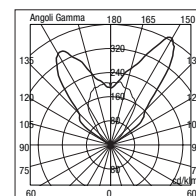
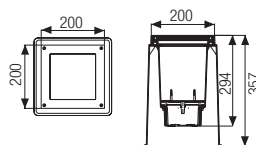

7033 78

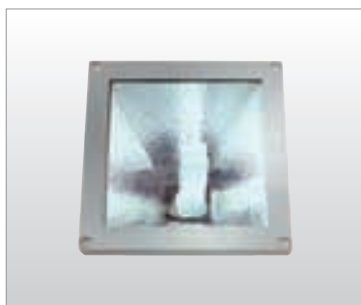

7036

- **7036.830** TC-T 26W GX24 d-3
 Con filtro anticalorico - With heat dissipating filter T < 40°C

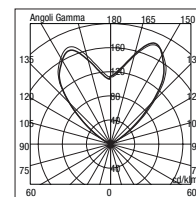
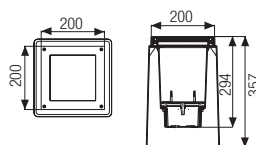

7036 83

QUAD 200

QUAD 200

ANELLO INOX con sporgenza fuori terra inferiore a 5 mm
 INOX RING with projection from the ground less than 5 mm

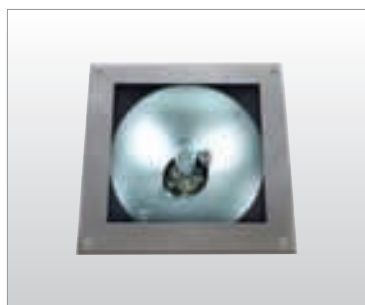

7230

- 7230.350** HIT 35W G12
 Riflettore simmetrico - Pos. lampadina basculante $\pm 15^\circ$
 Symmetrical reflector - Lamp position: tilting $\pm 15^\circ$
- Con filtro anticalorico - With heat dissipating filter $T < 70^\circ\text{C}$
- 7230.770** HIT 70W G12
 Riflettore simmetrico - Pos. lampadina basculante $\pm 15^\circ$
 Symmetrical reflector - Lamp position: tilting $\pm 15^\circ$
- 7230.880** 4LED bianco/white 16,4W 920 lm 6300 K

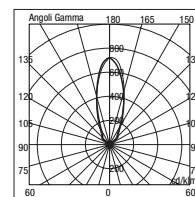
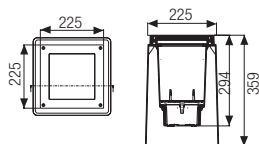

7230 77



7231

- 7231.780** HIT-DE 70W Rx7s
 Riflettore asimmetrico - Asymmetrical reflector

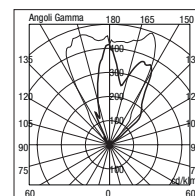
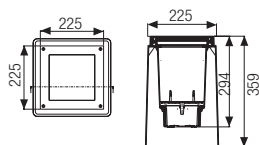

7231 78

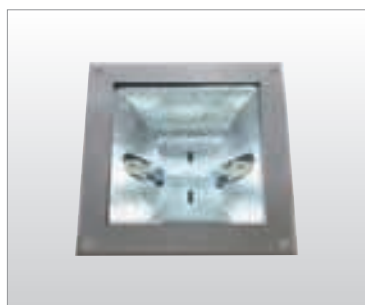

7233

- 7233.780** HIT-DE 70W Rx7s
 Riflettore simmetrico - Symmetrical reflector

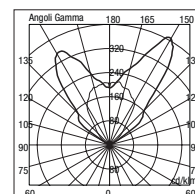
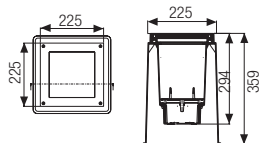

7233 78



7236

- 7236.830** TC-T 26W GX24 d-3
 Con filtro anticalorico - With heat dissipating filter $T < 40^\circ\text{C}$

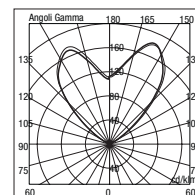
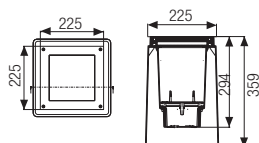

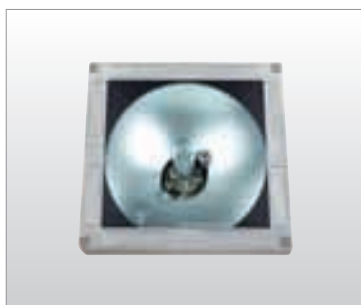

7236 83

ANELLO ALLUMINIO perfettamente a filo pavimento (sporgenza 0 mm)
 in modo da non intralciare il camminamento
*Perfectly flush with the floor ALUMINIUM RING (projection 0 mm)
 as do not obstacle the walking*



7430

- **7430.35X**  HIT 35W G12
 Riflettore simmetrico - Pos. lampadina basculante $\pm 15^\circ$
 Symmetrical reflector - Lamp position: tilting $\pm 15^\circ$
- Con filtro anticalorico - With heat dissipating filter T < 70°C
- **7430.77X**  HIT 70W G12
 Riflettore simmetrico - Pos. lampadina basculante $\pm 15^\circ$
 Symmetrical reflector - Lamp position: tilting $\pm 15^\circ$
- **7430.88X**  4LED bianco/white 16,4W 920 lm 6300 K

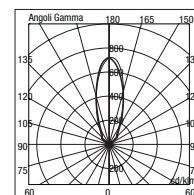
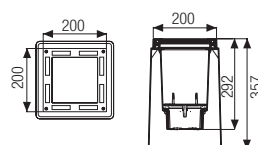

7430 77

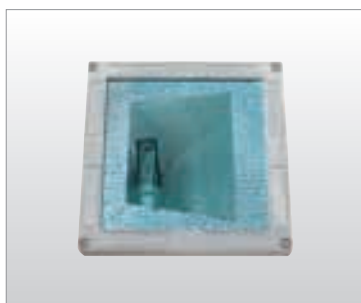

7431

- **7431.78X**  HIT-DE 70W Rx7s
 Riflettore asimmetrico - Asymmetrical reflector

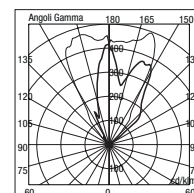
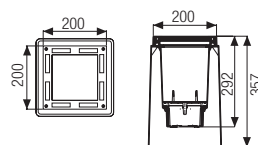

7431 78



7433

- **7433.78X**  HIT-DE 70W Rx7s
 Riflettore simmetrico - Symmetrical reflector

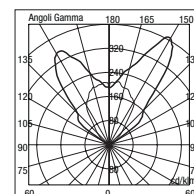
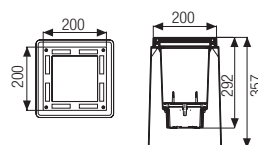

7433 78



7436

- **7436.83X**  TC-T 26W GX24 d-3
 ● Con filtro anticalorico - With heat dissipating filter T < 40°C

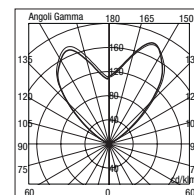
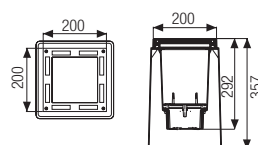

7436 83





DIG

DIG

Apparecchio da esterni per installazione a parete costituito da:

- Corpo in alluminio pressofuso verniciato
- Diffusore in vetro temperato satinato
- Parabola riflettente in alluminio
- Guarnizioni in silicone
- Viti di chiusura in acciaio inox
- Verniciatura in polveri poliestere ad elevata resistenza ai raggi ultravioletti e alla corrosione

Wall outdoor luminaire constructed of:

- Painted die-cast aluminium body
- Satin tempered glass diffuser
- Aluminium reflector
- Silicon gaskets
- Stainless steel screws
- Painting using high resistance to UV and corrosion polyester powders



Colori - Colours

X=2  Bianco
White

X=3  Nero
Black

X=9  Antracite
Anthracite

X=4  Silver

Diffusore - Diffuser

Codice-Code 00 5050

Le lampadine vengono fornite solo su richiesta ad eccezione della versione T2 6W e 60 LED

Bulbs supplied only on request except for T2 6W and 60 LED version

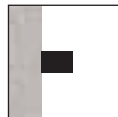

Installazione a parete

Wall mounting

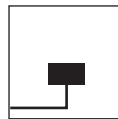

Entrata singola cavi di alimentazione

Single power supply cables input

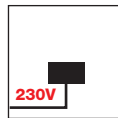

LED - art. 5050.88X

Led a tensione di rete 220/240V 50Hz.

Connessione diretta alla rete di alimentazione senza necessità di trasformatore.

LED's direct operation at 220/240V 50Hz.

No transformer is required.

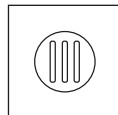

Fluorescente 6W Gx53

Non necessita di alcun alimentatore

Fluorescent lamp 6W Gx53

Does not need the power supplier

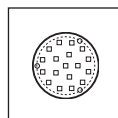

60 LED Gx53

Non necessita di alcun alimentatore.

60 LED Gx53



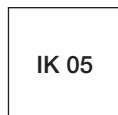

Does not need the power supplier



IK 05



5050

5050.14X		QT14 Halopin	75W	G9		
5050.76X		QT-DE12	60W	R7s		
• 5050.60X		T2	6W	Gx53		
• 5050.68X		60LED bianco/white	4W	Gx53	260 lm	4000 K
5050.88X		1LED bianco/white	4,1W		230 lm	6300 K

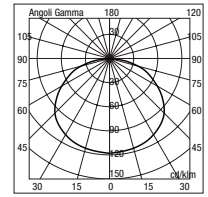
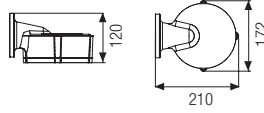

5050 60

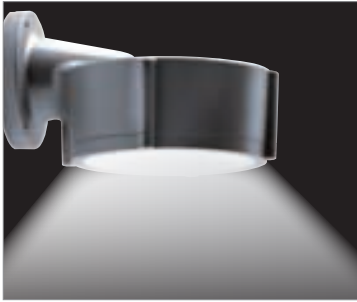

- L'apparecchio viene fornito completo di lampadina
Bulb enclosed to the luminaire

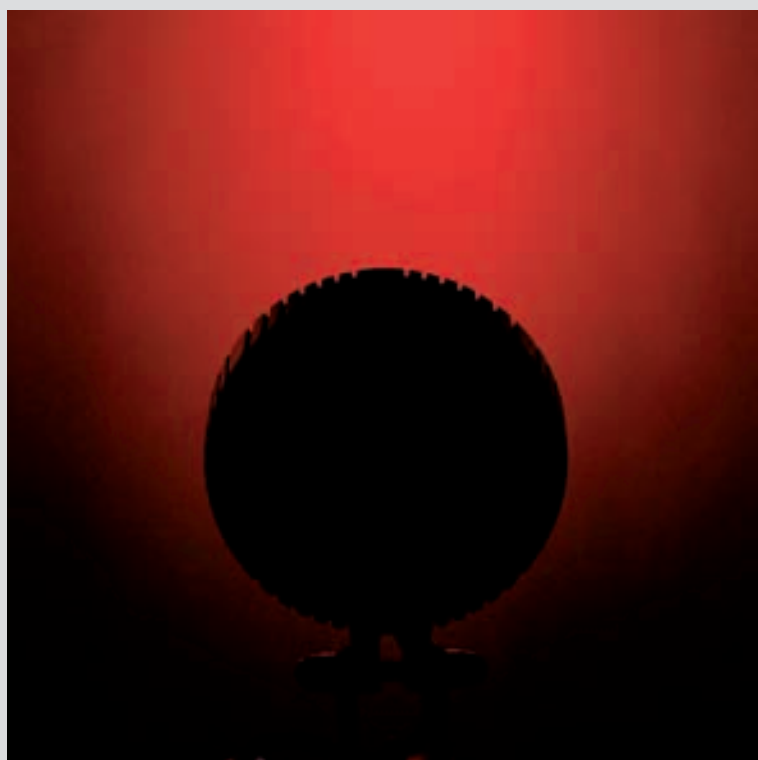



SPOTTY

SPOTTY

Proiettore orientabile per esterni ed interni applicabile a parete o a terra A TECNOLOGIA LED costituito da:

- Corpo in alluminio pressofuso verniciato
- Diffusore in policarbonato trasparente
- Guarnizioni in silicone
- Viti di chiusura in acciaio inox
- Verniciatura in polveri poliestere ad elevata resistenza ai raggi ultravioletti e alla corrosione

Adjustable outdoor and indoor wall or ground luminaire with LED TECHNOLOGY constructed of:

- Die-cast aluminium body
- Transparent polycarbonate diffuser
- Aluminium reflector
- Silicon gaskets
- Stainless steel screws
- Technopolymer holder
- Painting using high resistance to UV and corrosion polyester powders

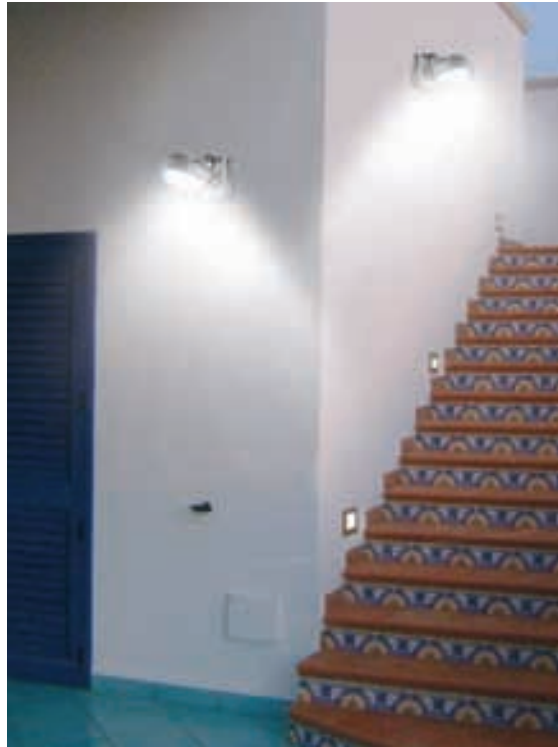

Colori - Colours

X=4  Silver

Colori 12 Led - 12 Led Colours



Diffusore - Diffuser

Codice-Code 00 8080

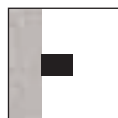

Installazione a parete
Wall mounting



Installazione a terra
Floor mounting

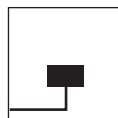

Entrata singola cavi di alimentazione
Single power supply cables input

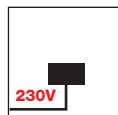

12 LED
L'apparecchio è fornito completo di alimentatore elettronico 90/250V posizionato all'interno dell'apparecchio.
The luminaire is supplied with a 90/250V built-in transformer

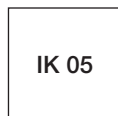

IK 05

APPARECCHIO ORIENTABILE
A TECNOLOGIA LED AD ALTA EFFICIENZA
INCLINAZIONE: 90°
ROTAZIONE: 330°

HIGH EFFICIENCY ADJUSTABLE LUMINAIRE
WITH LED TECHNOLOGY
INCLINATION: 90°
ROTATION: 330°

SPOTTY A TERRA CON PICCHETTO
Apparecchio provvisto di cavo
H05RN-F con spina 2P+T IP44

SPOTTY WITH SPIKE FOR GROUND
Luminaire provided with flexible cable
H05RN-F and plug 2P+T IP44

Installazione a parete

Wall mounting



8080

8080.664	12LED bianco/white	18W	1000 lm	5500 K
8080.674	12LED blu/blue	18W	1000 lm	5500 K
8080.684	12LED rosso/red	18W	1000 lm	5500 K

Con alimentatore elettronico incorporato / Built-in electronic power supplier

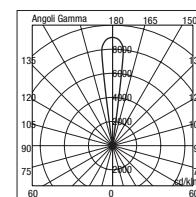
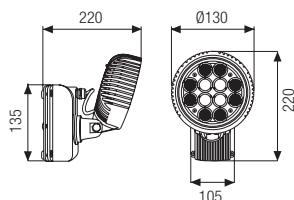

8080 66



Installazione a terra con picchetto

Ground fixing with spike



8090

8090.664	12LED bianco/white	18W	1000 lm	5500 K
8090.674	12LED blu/blue	18W	1000 lm	5500 K
8090.684	12LED rosso/red	18W	1000 lm	5500 K

Con alimentatore elettronico incorporato / Built-in electronic power supplier

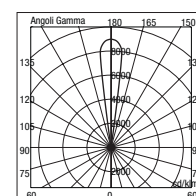
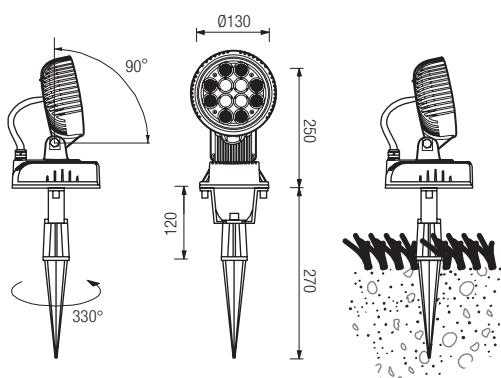

8090 66





SPRINT

SPRINT DOUBLE



SPRINT

Proiettore per interni ed esterni costituito da:

- Struttura in alluminio pressofuso verniciato
- Diffusore in vetro temperato satinato per QT12 e QT14 e trasparente per QR70
- Parabola riflettente in alluminio
- Guarnizioni in silicone
- Viti di chiusura in acciaio inox
- Verniciatura in polveri poliestere ad elevata resistenza ai raggi ultravioletti e alla corrosione

Indoor and outdoor spotlight constructed of:

- Painted die-cast aluminium structure
- Satin tempered glass diffuser for QT12 and QT14 and transparent glass diffuser for QR70
- Aluminium reflector
- Silicon gaskets
- Stainless steel screws
- Painting using high resistance to UV and corrosion polyester powders



Colori - Colours

X=9  Antracite
Anthracite

X=4  Silver

Diffusore - Diffuser

Codice-Code 00 4010
per/for QT12 - QT14

Codice-Code 05 4011
per/for QR70

Vetro cupolino trasparente
Domed transparent glass

Le lampadine vengono fornite
solo su richiesta

Bulbs supplied only
on request

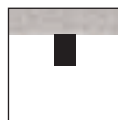

Installazione a soffitto
Ceiling mounting

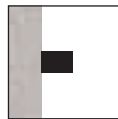

Installazione a parete
Wall mounting

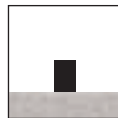

Installazione a terra
Floor mounting



IK 07

SPRINT CON PICCHETTO A TERRA
Apparecchio provvisto di cavo H05RN-F
con spina 2P+T IP44

SPRINT WITH GROUND SPIKE
Luminaire provided with flexible cable H05RN-F
and plug 2P+T IP44

Installazione a parete
Wall mounting

SPRINT

SPRINT



2010 ○ anello / ring

2010.12X QT12 50W GY 6.35 12V
Con trasformatore elettronico incorporato / Built-in electronic transformer
2010.14X QT14 Halopin 40W G9

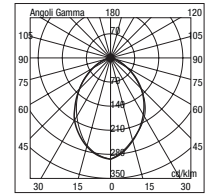
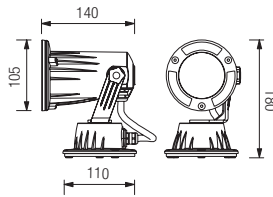

2010 14



2011 ● griglia / grid

2011.12X QT12 50W GY 6.35 12V
Con trasformatore elettronico incorporato / Built-in electronic transformer
2011.14X QT14 Halopin 40W G9

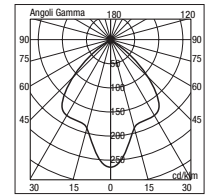
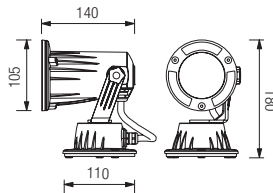

2011 14



2020 ○ anello / ring

2020.12X QT12 50W GY 6.35 12V
Con trasformatore elettronico incorporato / Built-in electronic transformer
2020.14X QT14 Halopin 40W G9
2020.40X QR70 50W BA15d 12V
Con trasformatore elettronico incorporato / Built-in electronic transformer

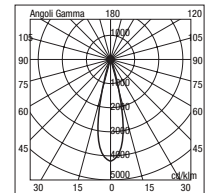
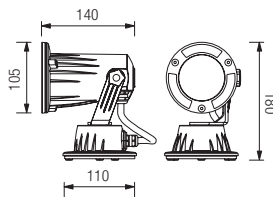

2020 40



2024

2024.12X QT12 50W GY 6.35 12V
Con trasformatore elettronico incorporato / Built-in electronic transformer
2024.14X QT14 Halopin 40W G9
2024.40X QR70 50W BA15d 12V
Con trasformatore elettronico incorporato / Built-in electronic transformer

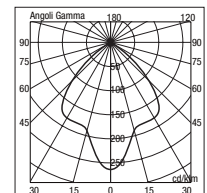
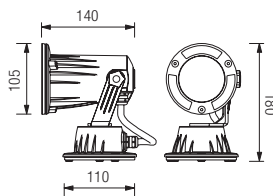

2024 14



Installazione a terra con picchetto

Ground fixing with spike



2041

● griglia / grid





2040

○ anello / ring

2041.12X  QT12 50W GY 6.35 12V

Con trasformatore elettronico incorporato / Built-in electronic transformer

2041.14X  QT14 Halopin 40W G9

2040.12X  QT12 50W GY 6.35 12V

Con trasformatore elettronico incorporato / Built-in electronic transformer

2040.14X  QT14 Halopin 40W G9

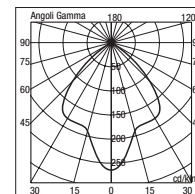

2041 14

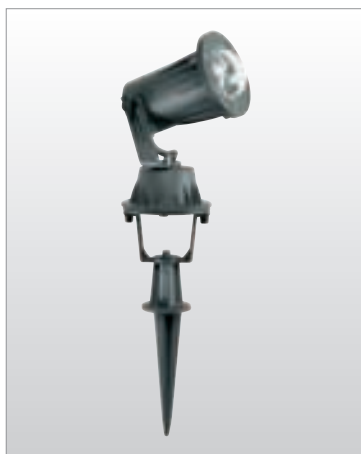
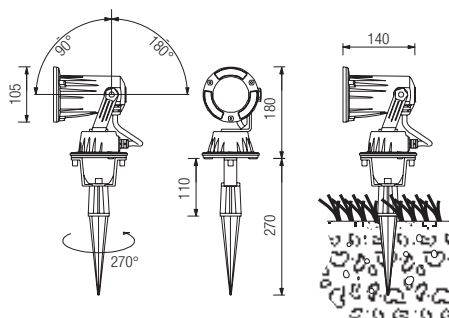

2050

○ anello / ring



2054

2050.12X  QT12 50W GY 6.35 12V

Con trasformatore elettronico incorporato / Built-in electronic transformer

2050.14X  QT14 Halopin 40W G9

2050.40X  QR70 50W BA15d 12V

Con trasformatore elettronico incorporato / Built-in electronic transformer

2054.12X  QT12 50W GY 6.35 12V

Con trasformatore elettronico incorporato / Built-in electronic transformer

2054.14X  QT14 Halopin 40W G9

2054.40X  QR70 50W BA15d 12V

Con trasformatore elettronico incorporato / Built-in electronic transformer

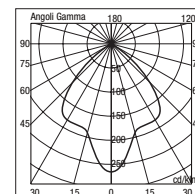

2050 14

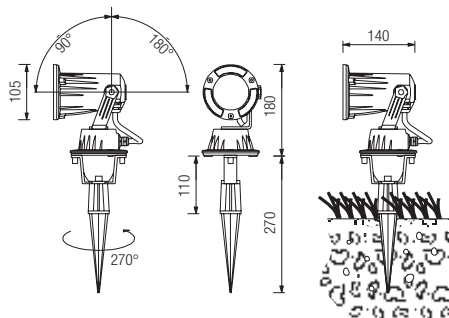

SPRINT DOUBLE

Proiettore per interni ed esterni
costituito da:

- Struttura in alluminio pressofuso verniciato
- Diffusore in vetro temperato satinato per QT12 e QT14 e trasparente per QR70
- Parabola riflettente in alluminio
- Guarnizioni in silicone
- Viti di chiusura in acciaio inox
- Verniciatura in polveri poliestere ad elevata resistenza ai raggi ultravioletti e alla corrosione

Indoor and outdoor spotlight constructed of:

- Painted die-cast aluminium structure
- Satin tempered glass diffuser for QT12 and QT14 and transparent glass diffuser for QR70
- Aluminium reflector
- Silicon gaskets
- Stainless steel screws
- Painting using high resistance to UV and corrosion polyester powders



Colori - Colours

X=9 Antracite
Anthracite

X=4 Silver

Diffusore - Diffuser

Codice-Code 00 4010
per/for QT12 - QT14

Codice-Code 05 4011
per/for QR70

Vetro cupolino trasparente
Domed transparent glass

Le lampadine vengono fornite
solo su richiesta

Bulbs supplied only
on request

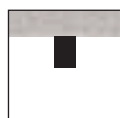
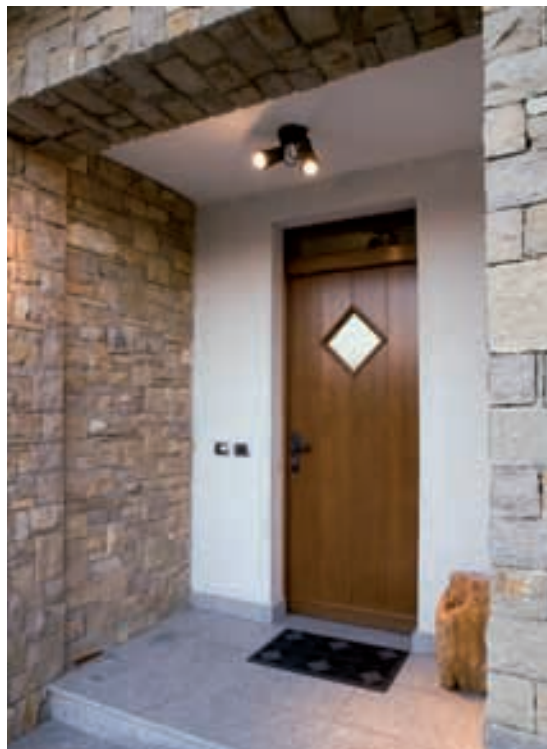

Installazione a soffitto
Ceiling mounting



Installazione a parete
Wall mounting

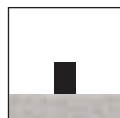

Installazione a terra
Floor mounting



SPRINT DOUBLE CON PICCHETTO A TERRA
Apparecchio provvisto di cavo H05RN-F
con spina 2P+T IP44

SPRINT DOUBLE WITH GROUND SPIKE
Luminaire provided with flexible cable H05RN-F
and plug 2P+T IP44

Installazione a parete Wall mounting



2220



2210

2211

2224

2220.12X QT12 2x50W GY 6.35 12V

Con trasformatore elettronico incorporato / Built-in electronic transformer

2220.14X QT14 Halopin 2x40W G9

2220.40X QR70 2x50W BA15d 12V
Con trasformatore elettronico incorporato / Built-in electronic transformer

2210.12X QT12 2x50W GY 6.35 12V

Con trasformatore elettronico incorporato / Built-in electronic transformer

2210.14X QT14 Halopin 2x40W G9

2211.12X QT12 2x50W GY 6.35 12V

Con trasformatore elettronico incorporato / Built-in electronic transformer

2211.14X QT14 Halopin 2x40W G9

2224.12X QT12 2x50W GY 6.35 12V

Con trasformatore elettronico incorporato / Built-in electronic transformer

2224.14X QT14 Halopin 2x40W G9

2224.40X QR70 2x50W BA15d 12V

Con trasformatore elettronico incorporato / Built-in electronic transformer

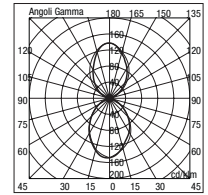
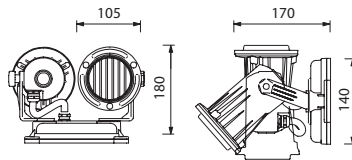

2220 12

Installazione a terra con picchetto Ground fixing with spike

Ground fixing with spike



2250



2240

2241

2254

2250.12X QT12 2x50W GY 6.35 12V

Con trasformatore elettronico incorporato / Built-in electronic transformer

2250.14X QT14 Halopin 2x40W G9

2250.40X QR70 2x50W BA15d 12V
Con trasformatore elettronico incorporato / Built-in electronic transformer

2240.12X QT12 2x50W GY 6.35 12V

Con trasformatore elettronico incorporato / Built-in electronic transformer

2240.14X QT14 Halopin 2x40W G9

2241.12X QT12 2x50W GY 6.35 12V

Con trasformatore elettronico incorporato / Built-in electronic transformer

2241.14X QT14 Halopin 2x40W G9

2254.12X QT12 2x50W GY 6.35 12V

Con trasformatore elettronico incorporato / Built-in electronic transformer

2254.14X QT14 Halopin 2x40W G9

2254.40X QR70 2x50W BA15d 12V

Con trasformatore elettronico incorporato / Built-in electronic transformer

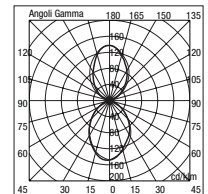
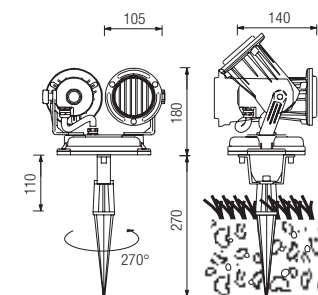

2250 12





SPARK

SPARK

Proiettore per interni ed esterni
costituito da:

- Corpo in alluminio pressofuso verniciato
- Diffusore in vetro trasparente temperato
- Parabola riflettente in alluminio
- Guarnizioni in silicone
- Viti di chiusura in acciaio inox
- Verniciatura in polveri poliesteri ad elevata resistenza ai raggi ultravioletti e alla corrosione

Indoor and outdoor spotlight constructed of:

- Painted die-cast aluminium body
- Transparent tempered glass diffuser
- Aluminium reflector
- Silicon gaskets
- Stainless steel screws
- Painting using high resistance to UV and corrosion polyester powders



Colori - Colours

X=9 Antracite
Anthracite

X=4 Silver

Diffusore - Diffuser

Codice-Code 00 1080

per-for SPARK 1 - MAXILUX

Le lampadine vengono fornite solo su richiesta

Bulbs supplied only on request

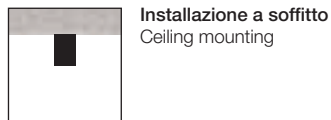

Installazione a soffitto
Ceiling mounting



Installazione a parete
Wall mounting

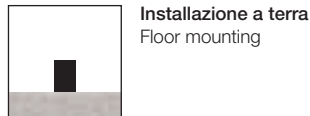

Installazione a terra
Floor mounting



IK 07



ACCESSORIO: CP 80
Accessorio in alluminio pressofuso per Spark Maxilux e Spark 1
Die-cast aluminium accessory for Spark Maxilux and Spark 1

SPARK CON PICCHETTO A TERRA
Apparecchio provvisto di cavo H05RN-F con spina 2P+T IP44

SPARK WITH GROUND SPIKE
Luminaire provided with flexible cable H05RN-F and plug 2P+T IP44

Direttiva/Directive
EuP/ErP (2005/52/CE-2009/125/CE)
Gli apparecchi per lampade a scarica ad alta intensità sono progettati per lampade chiare e opali.
Luminaires for high intensity discharge lamps are designed for either clear and coated lamps.

Installazione a parete Wall mounting



1080 ○ anello / ring



1081 ● griglia / grid

1080.00X		Q PAR30	75W	E27
1081.00X		Q PAR30	75W	E27

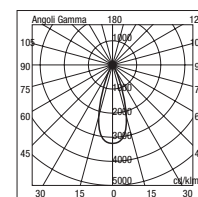
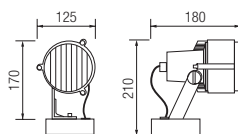

1080 00

Installazione a terra con picchetto Ground fixing with spike



1082 ○ anello / ring



1083 ● griglia / grid

1082.00X		Q PAR30	75W	E27
1083.00X		Q PAR30	75W	E27

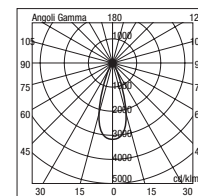
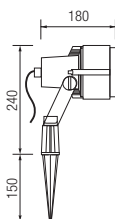

1083 00



SPARK 1

SPARK 1



1089 H 450  griglia / grid



1086 H 450  anello / ring



1088 H 700  anello / ring



1087 H 700  griglia / grid

Spark palo

- Faretto in alluminio pressofuso verniciato
- Palo in alluminio estruso verniciato

Spark post

- Painted die-cast aluminium spotlight
- Painted extruded aluminium post

1089.00X		Q PAR30	75W	E27
1086.00X		Q PAR30	75W	E27

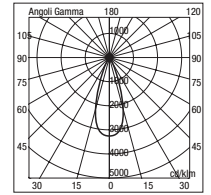
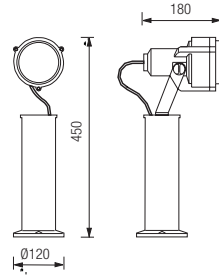

1089 00

1088.00X		Q PAR30	75W	E27
1087.00X		Q PAR30	75W	E27

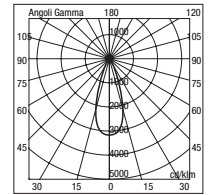
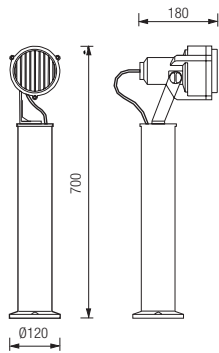

1087 00



Installazione a parete Wall mounting



1180 ○ anello / ring

1180.63X HIT 35W G12
Con reattore elettronico incorporato / Built-in electronic ballast

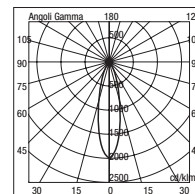
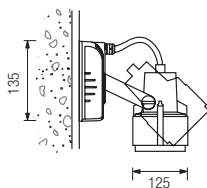

1180 63



1181 ● griglia / grid

1181.63X HIT 35W G12
Con reattore elettronico incorporato / Built-in electronic ballast

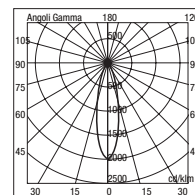
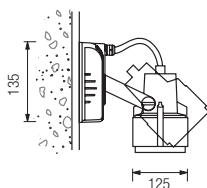

1181 63

Installazione a terra con picchetto Ground fixing with spike



1182 ○ anello / ring

1182.63X HIT 35W G12
Con reattore elettronico incorporato / Built-in electronic ballast

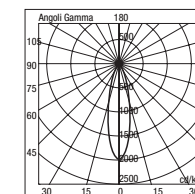
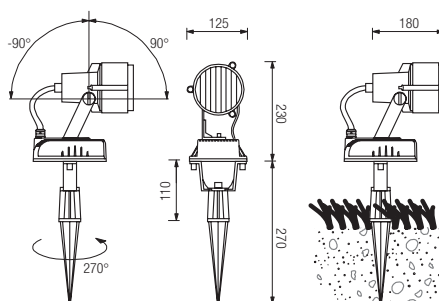

1182 63



1183 ● griglia / grid

1183.63X HIT 35W G12
Con reattore elettronico incorporato / Built-in electronic ballast

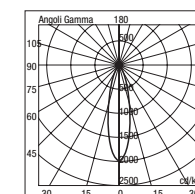
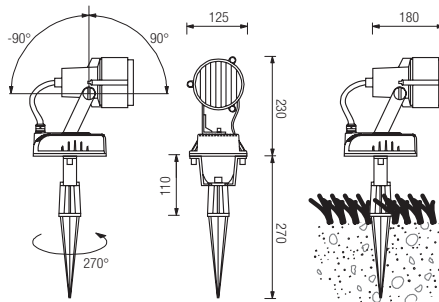

1183 63

SPARK BIG

Proiettore per interni ed esterni costituito da:

- Corpo in alluminio pressofuso verniciato
- Diffusore in vetro trasparente temperato
- Parabola riflettente in alluminio
- Guarnizioni in silicone
- Viti di chiusura in acciaio inox
- Verniciatura in polveri poliestere ad elevata resistenza ai raggi ultravioletti e alla corrosione

Indoor and outdoor spotlight constructed of:

- Painted die-cast aluminium body
- Transparent tempered glass diffuser
- Aluminium reflector
- Silicon gaskets
- Stainless steel screws
- Painting using high resistance to UV and corrosion polyester powders



Colori - Colours

X=9 Antracite
Anthracite

X=4 Silver

Diffusore - Diffuser

Codice-Code 00 1780

Le lampadine vengono fornite solo su richiesta

Bulbs supplied only on request

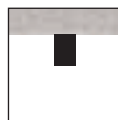

Installazione a soffitto
Ceiling mounting

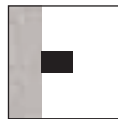

Installazione a parete
Wall mounting

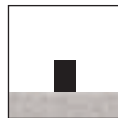

Installazione a terra
Floor mounting



IK 07



ACCESSORIO: CP 70
Accessorio in alluminio
Die-cast aluminium accessory

SPARK CON PICCHETTO A TERRA
Apparecchio provvisto di cavo H05RN-F
con spina 2P+T IP44

SPARK WITH GROUND SPIKE
Luminaire provided with flexible cable H05RN-F
and plug 2P+T IP44

Direttiva/Directive

EuP/ErP (2005/52/CE-2009/125/CE)

Gli apparecchi per lampade a scarica ad alta intensità sono progettati per lampade chiare e opali.

Luminaires for high intensity discharge lamps are designed for either clear and coated lamps.

Installazione a parete
Wall mounting



1780 ○ anello / ring

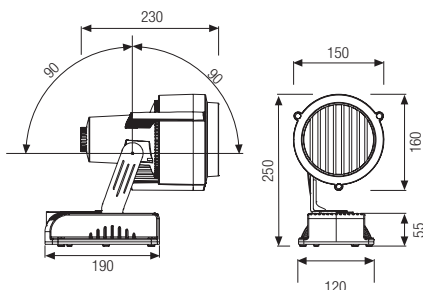

1780.74X		HIT	70W	G12
Con reattore elettronico incorporato / Built-in electronic ballast				
1780.75X		HIT	150W	G12
Con reattore elettronico incorporato / Built-in electronic ballast				
1780.00X		PAR38	120W	E27

SPARK BIG

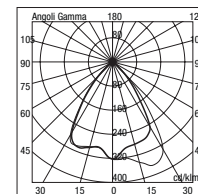

1780 74

SPARK BIG



1781 ● griglia / grid

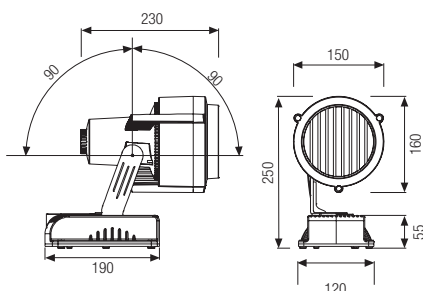

1781.74X		HIT	70W	G12
Con reattore elettronico incorporato / Built-in electronic ballast				
1781.75X		HIT	150W	G12
Con reattore elettronico incorporato / Built-in electronic ballast				
1781.00X		PAR38	120W	E27

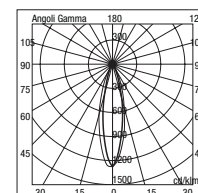

1781 00



Installazione a terra con picchetto
Ground fixing with spike



1782

1782.74X		HIT	70W	G12
Con reattore elettronico incorporato / Built-in electronic ballast				
1782.75X		HIT	150W	G12
Con reattore elettronico incorporato / Built-in electronic ballast				
1782.00X		PAR38	120W	E27

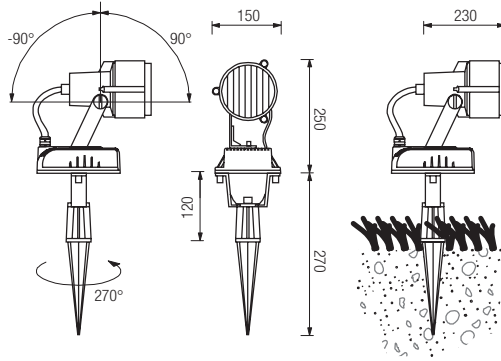

SPARK BIG

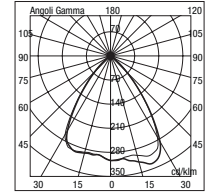

1782.75

SPARK BIG



1783

1783.74X		HIT	70W	G12
Con reattore elettronico incorporato / Built-in electronic ballast				
1783.75X		HIT	150W	G12
Con reattore elettronico incorporato / Built-in electronic ballast				
1783.00X		PAR38	120W	E27

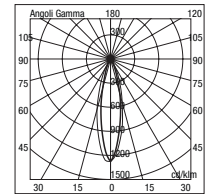
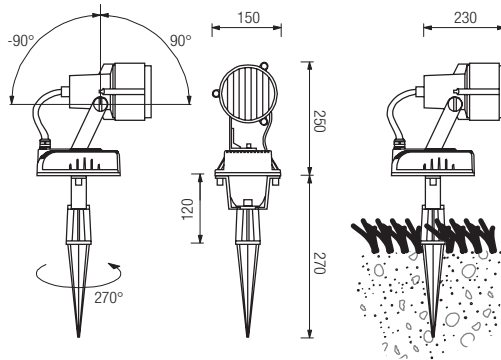

1783.00





SHOW

SHOW

Proiettore per interni ed esterni a parete, a soffitto o a terra costituito da:

- Struttura in alluminio pressofuso verniciato
- Diffusore in vetro temperato
- Guarnizioni in silicone
- Viti di chiusura in acciaio Inox
- Verniciatura in polveri poliestere ad elevata resistenza ai raggi ultravioletti e alla corrosione

Indoor and outdoor wall, ceiling or ground spotlight constructed of:

- Die-cast painted aluminium body
- Tempered glass diffuser
- Silicon gaskets
- Stainless steel screws
- Painting using high resistance to UV and corrosion polyester powders



Colori - Colours

X=2 Bianco
White

X=31 Antracite metallico
Anthracite metallic

Diffusore - Diffuser

Codice-Code 00 4050

Le lampadine vengono fornite solo su richiesta

Bulbs supplied only on request

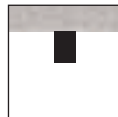

Installazione a soffitto
Ceiling mounting

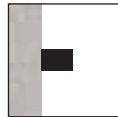

Installazione a parete
Wall mounting

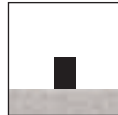

Installazione a terra
Floor mounting



IK 07

4060 - 4061
Apparecchio provvisto di cavo H05RN-F
con spina 2P+T IP44

4060 - 4061
Luminaire provided with flexible cable H05RN-F
and plug 2P+T IP44



Installazione a parete
Wall mounting



4050 ○ anello / ring

4050.15X Q PAR16 50W GU10

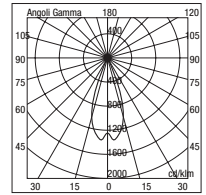
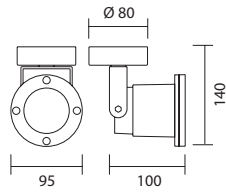

4050 15



4051 ● griglia / grid

4051.15X Q PAR16 50W GU10

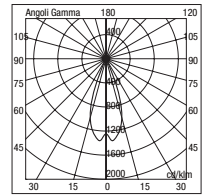
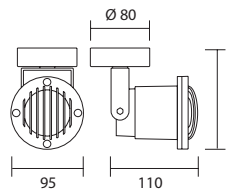

4051 15

Installazione a terra con picchetto
Ground fixing with spike



4060 ○ anello / ring

4060.15X Q PAR16 50W GU10

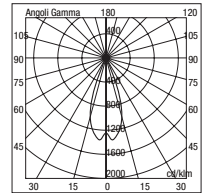
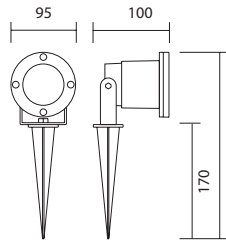

4060 15



4061 ● griglia / grid

4061.15X Q PAR16 50W GU10

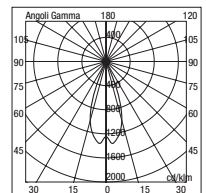
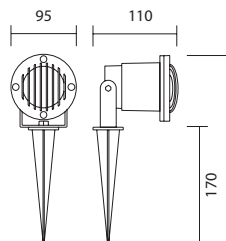

4061 15





GRETA

GRETA MINI

Apparecchio per illuminazione di esterni costituito da:

- Palo in alluminio estruso verniciato
- Struttura superiore in alluminio pressofuso verniciato
- Diffusore in vetro satinato
- Guarnizione in silicone
- Viti di chiusura in acciaio inox
- Verniciatura in polveri poliestere ad elevata resistenza ai raggi ultravioletti e alla corrosione

Outdoor luminaire constructed of:

- Painted extruded aluminium post
- Painted die-cast aluminium head
- Satin glass diffuser
- Silicon gasket
- Stainless steel screws
- Painting using high resistance to UV and corrosion polyester powders



Colori - Colours

X=3  Nero
Black

X=9  Antracite
Anthracite

X=4  Silver

Diffusore - Diffuser

Codice-Code 00 3050

Le lampadine vengono fornite solo su richiesta

Bulbs supplied only on request

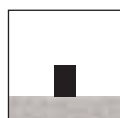

Installazione a terra
Floor mounting

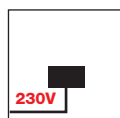

7 LED

L'apparecchio è fornito completo di alimentatore elettronico Full Range 100/240V 50/60Hz posizionato all'interno dell'apparecchio.
The luminaire is supplied with a Full Range 100/240V 50/60Hz built-in transformer.



IK 07

Direttiva/Directive
EuP/ErP (2005/52/CE-2009/125/CE)

Gli apparecchi per lampade a scarica ad alta intensità sono progettati per lampade chiare e opali.

Luminaires for high intensity discharge lamps are designed for either clear and coated lamps.

GRETA MINI

GRETA MINI



3056 H 208

3056.00X		A60	75W	E27
3056.92X		TC-D	10W	G24 d-1
3056.66X		7LED bianco/white	8,4W	945 lm 6000 K

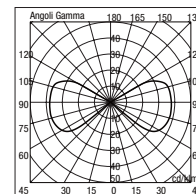
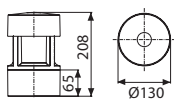

3056 92

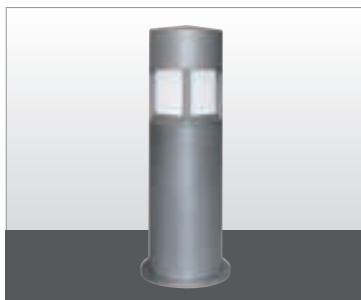

3052 H 360

3052.00X		A60	75W	E27
3052.83X		TC-T	26W	GX24 d-3
3052.35X		HIT	35W	G12
3052.66X		7LED bianco/white	8,4W	945 lm 6000 K

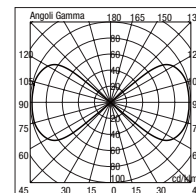
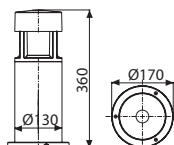

3052 35

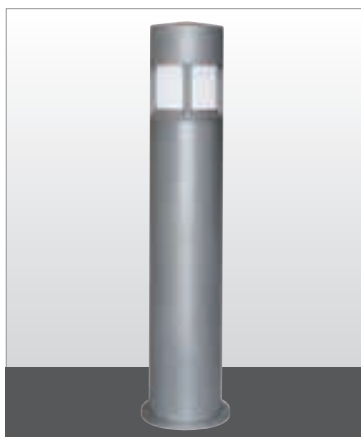

3051 H 650

3051.00X		A60	75W	E27
3051.83X		TC-T	26W	GX24 d-3
3051.35X		HIT	35W	G12
3051.66X		7LED bianco/white	8,4W	945 lm 6000 K

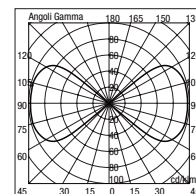
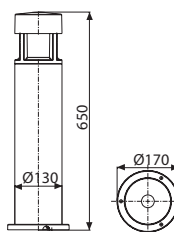

3051 35



3050 H 1000

3050.00X		A60	75W	E27
3050.83X		TC-T	26W	GX24 d-3
3050.35X		HIT	35W	G12
3050.66X		7LED bianco/white	8,4W	945 lm 6000 K

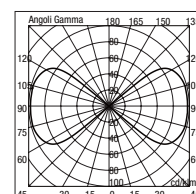
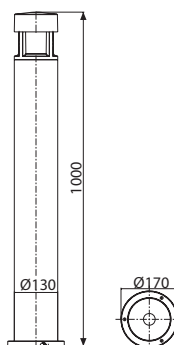

3050 35

GRETA BIG

Apparecchio per illuminazione di esterni a luce diretta o indiretta costituito da:



- Palo in alluminio estruso verniciato
- Struttura superiore in alluminio pressofuso verniciato
- Diffusore in vetro satinato o trasparente
- Parabola riflettente in alluminio
- Guarnizione in silicone
- Viti di chiusura in acciaio inox
- Verniciatura in polveri poliestere ad elevata resistenza ai raggi ultravioletti e alla corrosione

Outdoor luminaire constructed of:

- Painted extruded aluminium post
- Painted die-cast aluminium head
- Satin or transparent glass diffuser
- Aluminium reflector
- Silicon gasket
- Stainless steel screws
- Painting using high resistance to UV and corrosion polyester powders



Colori - Colours

- X=3  Nero
Black
- X=9  Antracite
Anthracite
- X=4  Silver

Diffusore - Diffuser

Codice-Code 00 8040

vetro satinato/satin glass

Codice-Code 00 8140

vetro trasparente/transparent glass

Le lampadine vengono fornite solo su richiesta

Bulbs supplied only on request

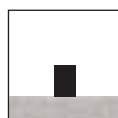

Installazione a terra
Floor mounting

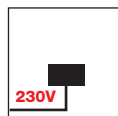

7 LED

L'apparecchio è fornito completo di alimentatore elettronico Full Range 100/240V 50/60Hz posizionato all'interno dell'apparecchio.
The luminaire is supplied with a Full Range 100/240V 50/60Hz built-in transformer.



IK 07

Direttiva/Directive
EuP/ErP (2005/52/CE-2009/125/CE)

Gli apparecchi per lampade a scarica ad alta intensità sono progettati per lampade chiare e opali.

Luminaires for high intensity discharge lamps are designed for either clear and coated lamps.



Apparecchio a luce indiretta - Vetro trasparente
Indirect light luminaire - Transparent glass

GRETA BIG



8146 H 260

8146.00X A60 100W E27

8146.35X HIT 35W G12

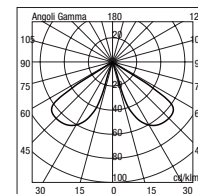
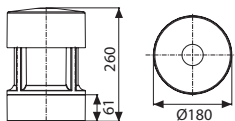

8146 35



8142 H 400

8142.00X A60 100W E27

8142.35X HIT 35W G12

8142.77X HIT 70W G12

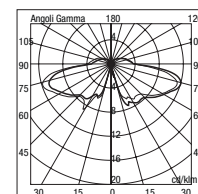
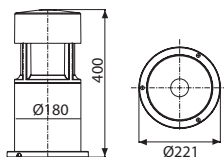

8142 77



8141 H 700

8141.00X A60 100W E27

8141.35X HIT 35W G12

8141.77X HIT 70W G12

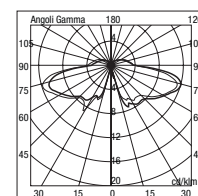
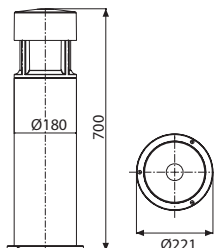

8141 77



8140 H 1100

8140.00X A60 100W E27

8140.35X HIT 35W G12

8140.77X HIT 70W G12

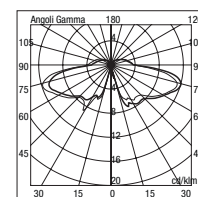
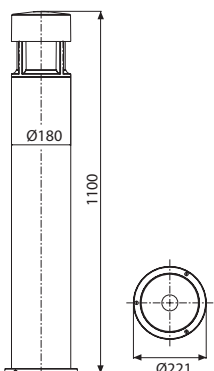

8140 77

GRETA BIG



Vetro satinato
Satin glass

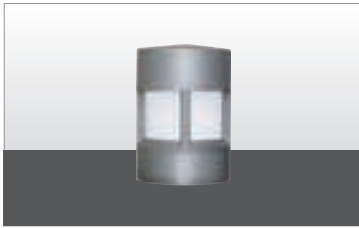

8046 H 260

8046.00X		A60	100W	E27
8046.83X		TC-T	26W	GX24 d-3
8046.35X		HIT	35W	G12
8046.66X		7LED bianco/white	15W	1400 lm 6000 K

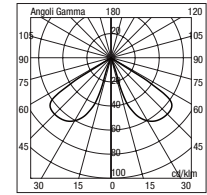
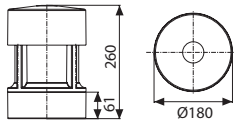

8046 35



8042 H 400

8042.00X		A60	100W	E27
8042.81X		TC-TEL	26-32-42W	GX24 q-3-4
Con reattore elettronico / With electronic ballast				
8042.35X		HIT	35W	G12
8042.66X		7LED bianco/white	15W	1400 lm 6000 K

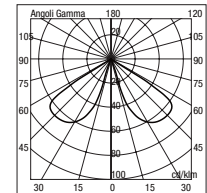
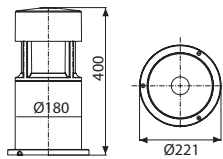

8042 35



8041 H 700

8041.00X		A60	100W	E27
8041.81X		TC-TEL	26-32-42W	GX24 q-3-4
Con reattore elettronico / With electronic ballast				
8041.35X		HIT	35W	G12
8041.66X		7LED bianco/white	15W	1400 lm 6000 K

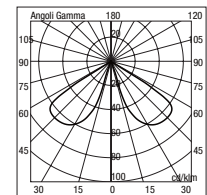
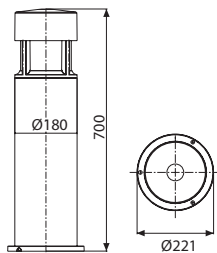

8041 35



8040 H 1100

8040.00X		A60	100W	E27
8040.81X		TC-TEL	26-32-42W	GX24 q-3-4
Con reattore elettronico / With electronic ballast				
8040.35X		HIT	35W	G12
8040.66X		7LED bianco/white	15W	1400 lm 6000 K

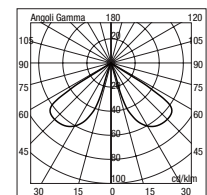
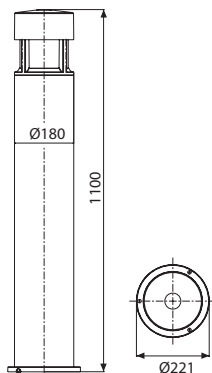

8040 35

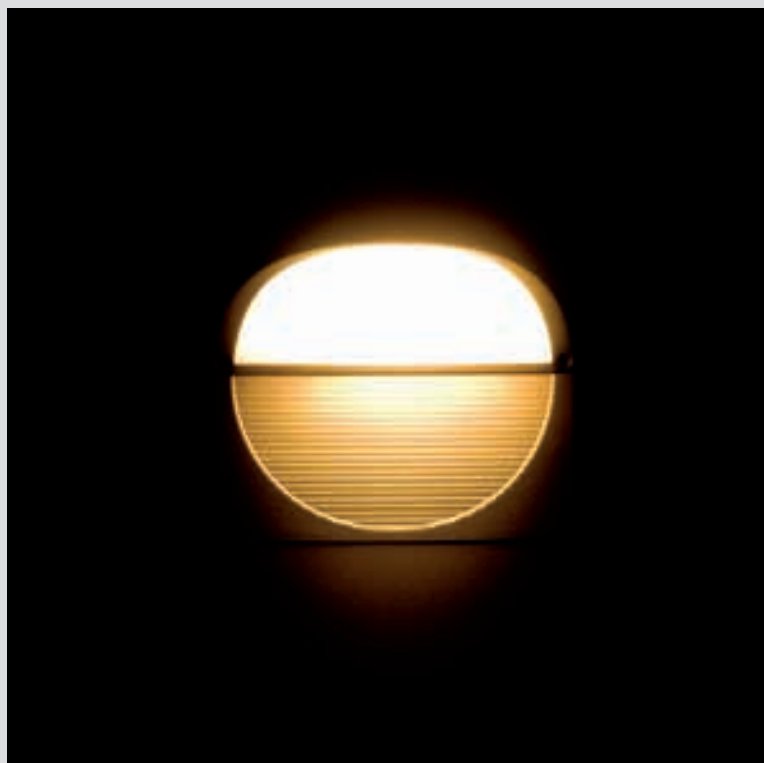



ENCO

ENCO STELO



ENCO

Apparecchio per illuminazione di esterni costituito da:

- Palo in alluminio estruso verniciato
- Struttura superiore in alluminio pressofuso verniciato
- Diffusore in policarbonato
- Parabola riflettente in alluminio
- Guarnizione in silicone
- Viti di chiusura in acciaio inox
- Verniciatura in polveri poliestere ad elevata resistenza ai raggi ultravioletti e alla corrosione

Outdoor luminaire constructed of:

- Painted extruded aluminium post
- Painted die-cast aluminium head
- Polycarbonate diffuser
- Aluminium reflector
- Silicon gasket
- Stainless steel screws
- Painting using high resistance to UV and corrosion polyester powders



Colori - Colours

X=2  Bianco
White

X=3  Nero
Black

X=9  Antracite
Anthracite

X=4  Silver

Diffusore - Diffuser

Codice-Code 08 4080

Le lampadine vengono fornite solo su richiesta

Bulbs supplied only on request

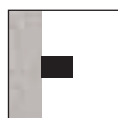

4080
Installazione a parete
Wall mounting



4082 - 4084
4086 - 4088
Installazione a terra
Floor mounting

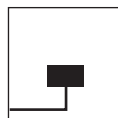

Entrata singola
cavi di alimentazione
Single power supply
cables input

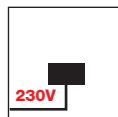

LED - art. 4080.88X
Led a tensione di rete 220/240V 50Hz.
Connessione diretta alla rete di alimentazione
senza necessità di trasformatore.
LED's direct operation at 220/240V 50Hz.
No transformer is required.

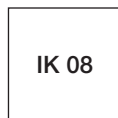

IK 08





4080

4080.00X		A60	75W	E27
4080.95X		TC-D	26W	G24 d-3
4080.88X		2LED bianco/white	8,2W	460 lm 6300 K

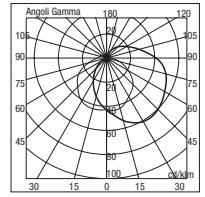
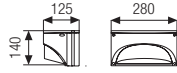

4080 95



4086 H 700
4082 H 1100

4086.00X		A60	75W	E27
4086.95X		TC-D	26W	G24 d-3
4086.81X		TC-TEL 26-32-42W	GX24 q-3-4	

Con reattore elettronico / With electronic ballast

4086.88X		2LED bianco/white	8,2W	460 lm 6300 K
-----------------	--	-------------------	------	---------------

4082.00X		A60	75W	E27
4082.95X		TC-D	26W	G24 d-3
4082.81X		TC-TEL 26-32-42W	GX24 q-3-4	

Con reattore elettronico / With electronic ballast

4082.88X		2LED bianco/white	8,2W	460 lm 6300 K
-----------------	--	-------------------	------	---------------

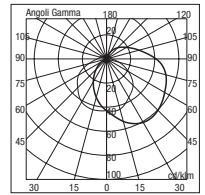
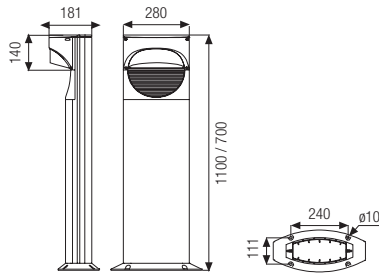

4086 95

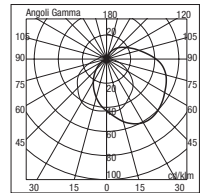

4082 95

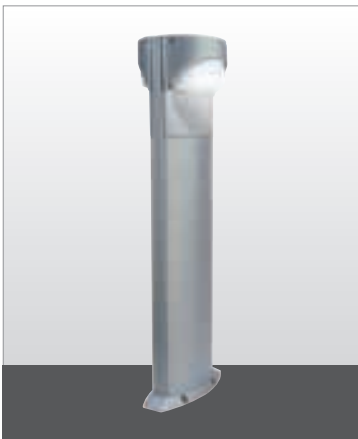

4084 H 700 doppia/double
4088 H 1100 doppia/double

4084.00X		A60	2x75W	E27
4084.95X		TC-D	2x26W	G24 d-3
4084.81X		TC-TEL 2x26-32W	GX24 q-3	

Con reattore elettronico / With electronic ballast

4088.00X		A60	2x75W	E27
4088.95X		TC-D	2x26W	G24 d-3
4088.81X		TC-TEL 2x26-32W	GX24 q-3	

Con reattore elettronico / With electronic ballast

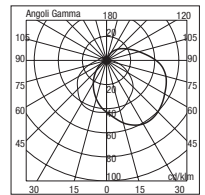
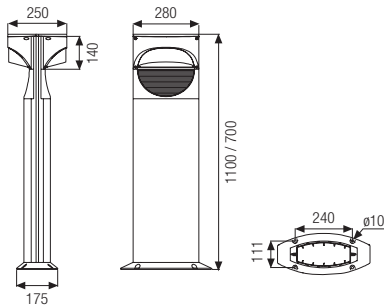

4084 95

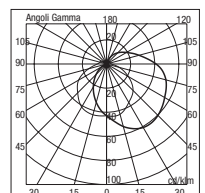

4088 95





SELECTA

SELECTA STELO



SELECTA

Apparecchio per interni ed esterni a parete o a soffitto.

Disponibile in due diverse dimensioni MINI e BIG costituito da:

- Corpo in alluminio pressofuso verniciato
- Diffusore in vetro opale temperato
- Parabola riflettente in alluminio
- Guarnizioni in EPDM e in silicone
- Viti di chiusura in acciaio inox
- Verniciatura in polveri poliestere ad elevata resistenza ai raggi ultravioletti e alla corrosione

Indoor and outdoor wall or ceiling luminaire available in two different dimensions MINI and BIG constructed of:

- Painted die-cast aluminium body
- Tempered opal glass diffuser
- Aluminium reflector
- EPDM and silicon gaskets
- Stainless steel screws
- Painting using high resistance to UV and corrosion polyester powders

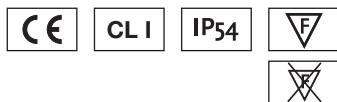

Colori - Colours

X=2  Bianco
White

X=3  Nero
Black

X=9  Antracite
Anthracite

X=4  Silver

Diffusore - Diffuser

Codice-Code 00 2080 BIG
00 5040 MINI

Le lampadine vengono fornite solo su richiesta

Bulbs supplied only on request

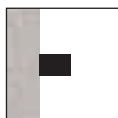

Installazione a parete
Wall mounting



2083 - 5043
Installazione a soffitto
Ceiling mounting

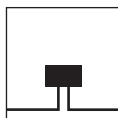

Doppia entrata
cavi di alimentazione
Double power supply
cables input

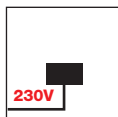

16 LED
L'apparecchio è fornito completo di alimentatore elettronico Full Range 100/240V 50/60Hz posizionato all'interno dell'apparecchio.
The luminaire is supplied with a Full Range 100/240V 50/60 Hz built-in transformer.



IK 07

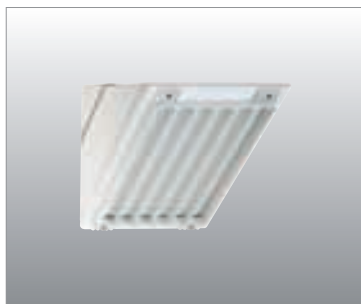

2080 BIG
5040 MINI

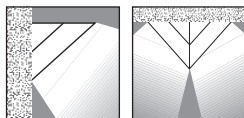

SELECTA BIG

2080.00X		A65	150W	E27	
2080.51X		HME	50W	E27	
2080.86X		TC-F	36W	2G10	
2080.76X		QT-DE 12	300W	R7s-15	
2080.66X		16LED bianco/white	14W	1170 lm 4000 K	

Con alimentatore elettronico incorporato / Built-in electronic power supplier

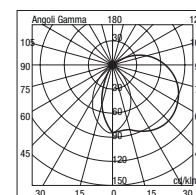

5040 86

SELECTA MINI

5040.00X		A60	100W	E27	
5040.86X		TC-F	24W	2G10	
5040.66X		16LED bianco/white	14W	1170 lm 4000 K	

Con alimentatore elettronico incorporato / Built-in electronic power supplier

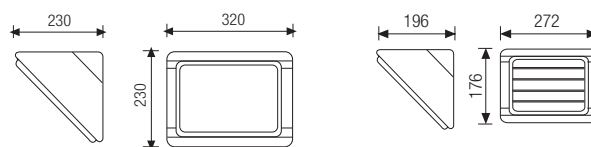

BIG

MINI



2081 BIG
5041 MINI

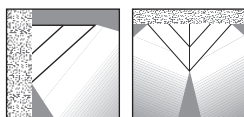

SELECTA BIG

2081.00X		A65	150W	E27	
2081.51X		HME	50W	E27	
2081.86X		TC-F	36W	2G10	
2081.76X		QT-DE 12	300W	R7s-15	
2081.66X		16LED bianco/white	14W	1170 lm 4000 K	

Con alimentatore elettronico incorporato / Built-in electronic power supplier

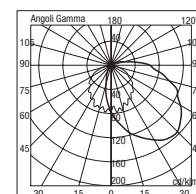

2081 00

SELECTA MINI

5041.00X		A60	100W	E27	
5041.86X		TC-F	24W	2G10	
5041.66X		16LED bianco/white	14W	1170 lm 4000 K	

Con alimentatore elettronico incorporato / Built-in electronic power supplier

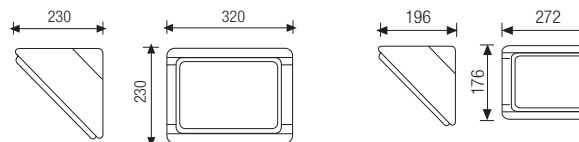

BIG

MINI



2083 BIG
5043 MINI

SELECTA BIG

2083.00X		A65	150W	E27	
2083.86X		TC-F	36W	2G10	
2083.66X		16LED bianco/white	14W	1170 lm 4000 K	

Con alimentatore elettronico incorporato / Built-in electronic power supplier

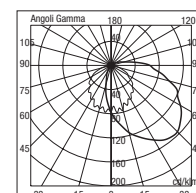

2083 00

SELECTA MINI

5043.00X		A60	100W	E27	
5043.86X		TC-F	24W	2G10	
5043.66X		16LED bianco/white	14W	1170 lm 4000 K	

Con alimentatore elettronico incorporato / Built-in electronic power supplier

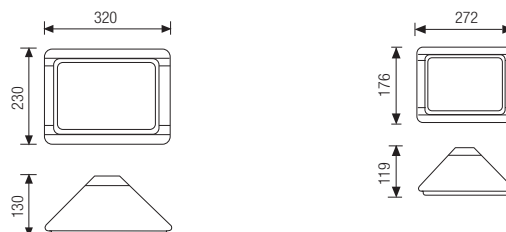

BIG

MINI

SELECTA STELO

Piantana da giardino per esterni.
Costituito da:

- Corpo in alluminio pressofuso verniciato
- Diffusore in vetro opale temperato
- Parabola riflettente in alluminio
- Guarnizioni in EPDM e in silicone
- Viti di chiusura in acciaio inox
- Verniciatura in polveri poliesteri ad elevata resistenza ai raggi ultravioletti e alla corrosione
- A richiesta supporto di installaggio CP 20 per SELECTA BIG

Outdoor post garden luminaire constructed of:

- Painted die-cast aluminium body
- Tempered opal glass diffuser
- Aluminium reflector
- EPDM and silicon gaskets
- Stainless steel screws
- Painting using high resistance to UV and corrosion polyester powders
- Installation support CP 20 for SELECTA BIG on request



Colori - Colours

X=2 Bianco White

X=3 Nero Black

X=9 Antracite Anthracite

X=4 Silver

Diffusore - Diffuser

Codice-Code 00 2080 BIG
00 5040 MINI

Le lampadine vengono fornite solo su richiesta

Bulbs supplied only on request

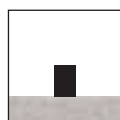

SELECTA STELO
Installazione a terra
SELECTA STELO
Floor mounting

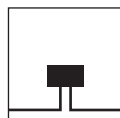

Doppia entrata cavi di alimentazione
Double power supply cables input

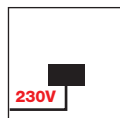

16 LED
L'apparecchio è fornito completo di alimentatore elettronico Full Range 100/240V 50/60Hz posizionato all'interno dell'apparecchio.

The luminaire is supplied with a Full Range 100/240V 50/60 Hz built-in transformer.



IK 07

CP 20
Controbases di fissaggio a terra per piantane
SELECTA BIG
Root-mount for pedestal luminaire ground fixing

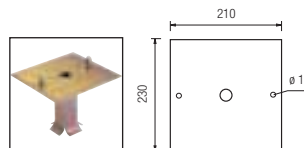



2092 BIG H 1200 ● griglia / grid
5062 MINI H 1000 ● griglia / grid



2093 BIG H 1200 ○ anello / ring
5063 MINI H 1000 ○ anello / ring

SELECTA BIG

con griglia / grid

2092.00X		A65	150W	E27
2092.71X		HME	80W	E27
2092.86X		TC-F	36W	2G10
● 2092.66X		16LED bianco/white	14W	1170 lm 4000 K

con anello / ring

2093.00X		A65	150W	E27
2093.71X		HME	80W	E27
2093.86X		TC-F	36W	2G10
● 2093.66X		16LED bianco/white	14W	1170 lm 4000 K

SELECTA MINI

con griglia / grid

5062.00X		A60	100W	E27
5062.86X		TC-F	24W	2G10
● 5062.66X		16LED bianco/white	14W	1170 lm 4000 K

con anello / ring

5063.00X		A60	100W	E27
5063.86X		TC-F	24W	2G10
● 5063.66X		16LED bianco/white	14W	1170 lm 4000 K

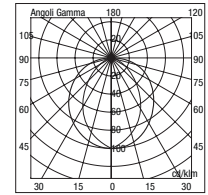

2092 86

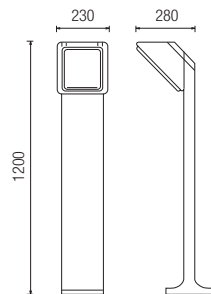

BIG

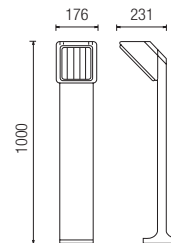

MINI



2097 BIG H 850 ○ anello / ring
5067 MINI H 650 ○ anello / ring



2096 BIG H 850 ● griglia / grid
5066 MINI H 650 ● griglia / grid

SELECTA BIG

con griglia / grid

2096.00X		A65	150W	E27
2096.71X		HME	80W	E27
2096.86X		TC-F	36W	2G10
● 2096.66X		16LED bianco/white	14W	1170 lm 4000 K

con anello / ring

2097.00X		A65	150W	E27
2097.71X		HME	80W	E27
2097.86X		TC-F	36W	2G10
● 2097.66X		16LED bianco/white	14W	1170 lm 4000 K

SELECTA MINI

con griglia / grid

5066.00X		A60	100W	E27
5066.86X		TC-F	24W	2G10
● 5066.66X		16LED bianco/white	14W	1170 lm 4000 K

con anello / ring

5067.00X		A60	100W	E27
5067.86X		TC-F	24W	2G10
● 5067.66X		16LED bianco/white	14W	1170 lm 4000 K

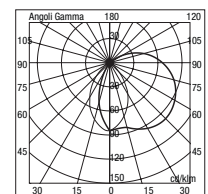

5066 86

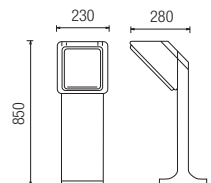

BIG

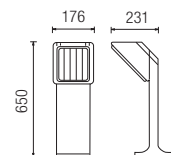

MINI

● Con alimentatore elettronico incorporato / Built-in electronic power supplier



SELECTA STELO

SELECTA STELO



2094 BIG H 1200  griglia / grid
5064 MINI H 1000  griglia / grid



2095 BIG H 1200  anello / ring
5065 MINI H 1000  anello / ring

SELECTA BIG

con griglia / grid

2094.00X  A65 2x150W E27

2094.71X  HME 2x80W E27

2094.86X  TC-F 2x36W 2G10

con anello / ring

2095.00X  A65 2x150W E27

2095.71X  HME 2x80W E27

2095.86X  TC-F 2x36W 2G10

SELECTA MINI

con griglia / grid

5064.00X  A60 2x100W E27

5064.86X  TC-F 2x24W 2G10

con anello / ring

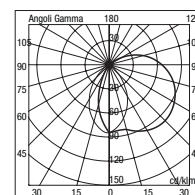
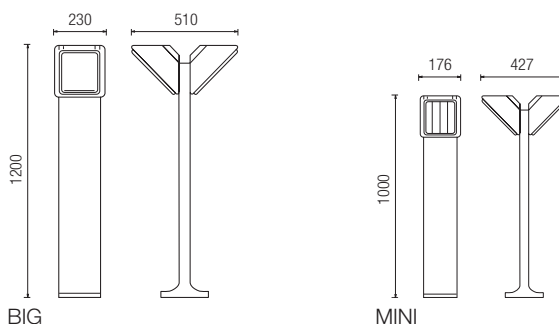

5065.00X  A60 2x100W E27

5065.86X  TC-F 2x24W 2G10





5064 86



2099 BIG H 850  anello / ring
5069 MINI H 650  anello / ring



2098 BIG H 850  griglia / grid
5068 MINI H 650  griglia / grid

SELECTA BIG

con griglia / grid

2098.00X  A65 2x150W E27

2098.71X  HME 2x80W E27

2098.86X  TC-F 2x36W 2G10

con anello / ring

2099.00X  A65 2x150W E27

2099.71X  HME 2x80W E27

2099.86X  TC-F 2x36W 2G10

SELECTA MINI

con griglia / grid

5068.00X  A60 2x100W E27

5068.86X  TC-F 2x24W 2G10

con anello / ring

5069.00X  A60 2x100W E27

5069.86X  TC-F 2x24W 2G10

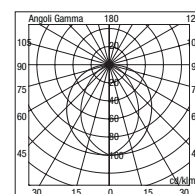
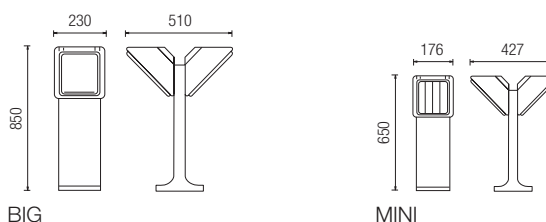

2098 86

S 90.00X



SELECTA BIG

ACCESSORIO:

Supporto orientabile a doppia installazione in alluminio pressofuso privo di parte elettrica da inserire su palo Ø 60.

Double direction fixing bracket without electrical components suitable for Ø 60 mm post fixing.

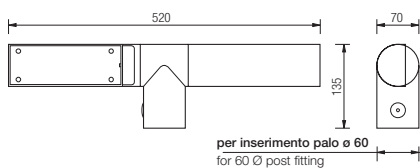

S 80.00X



SELECTA BIG

ACCESSORIO:

Supporto orientabile a installazione singola in alluminio pressofuso privo di parte elettrica da inserire su palo Ø 60.

Mono direction fixing bracket without electrical components suitable for Ø 60 mm post fixing.

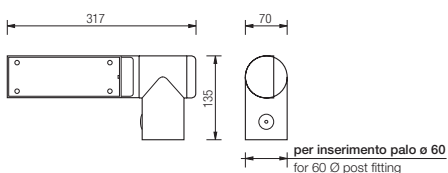

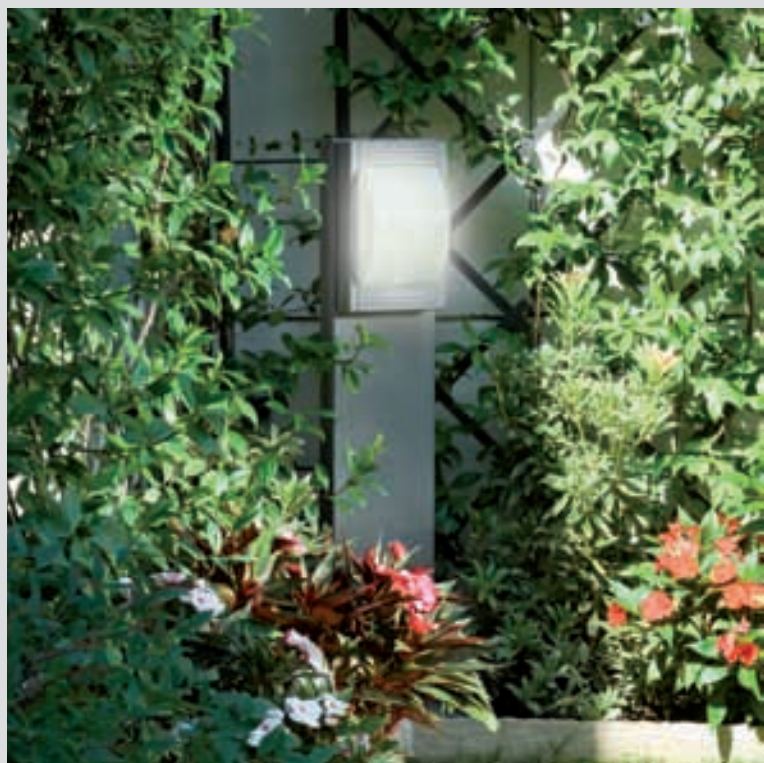



DUNE

DUNE STELO



DUNE

Apparecchio per interni ed esterni costituito da:

- Corpo in alluminio pressofuso verniciato
- Palo in alluminio estruso
- Diffusore in vetro satinato
- Parabola riflettente in alluminio
- Guarnizioni in EPDM
- Viti di chiusura in acciaio inox
- Verniciatura in polveri poliestere ad elevata resistenza ai raggi ultravioletti e alla corrosione

Indoor and outdoor luminaire constructed of:

- Painted die-cast aluminium body
- Extruded aluminium post
- Internally satin glass diffuser
- Aluminium reflector
- EPDM gaskets
- Stainless steel screws
- Painting using high resistance to UV and corrosion polyester powders



Colori - Colours

X=2  Bianco
White

X=3  Nero
Black

X=9  Antracite
Anthracite

X=4  Silver

Diffusore - Diffuser

Codice-Code 00 5020

Le lampadine vengono fornite solo su richiesta

Bulbs supplied only on request

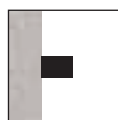

Cod. 5020 - 5030
Installazione a parete
Wall mounting



Cod. 5020
Installazione a soffitto
Ceiling mounting

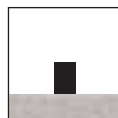

DUNE STELO
Installazione a terra
DUNE POST
Floor mounting

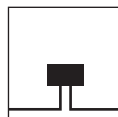

Doppia entrata
cavi di alimentazione
Double power supply
cables input

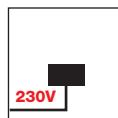

LED - art. 5020.88X - 5021.88X - 5022.88X
art. 5028.88X - 5030.88X - 5031.88X
art. 5032.88X

Led a tensione di rete 220/240V 50Hz.
Connessione diretta alla rete di alimentazione
senza necessità di trasformatore.
LED's direct operation at 220/240V 50Hz.
No transformer is required.



IK 05

CP 20

Per/for 5021 - 5022 - 5028

Controbasse di fissaggio a terra per piantane
Root-mount for pedestal luminaire ground fixing

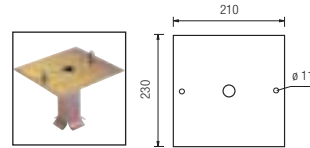



5020

5020.00X		A60	100W	E27
5020.96X		TC-D	18W	G24 d-2
5020.95X		TC-D	26W	G24 d-3
5020.88X		3LED bianco/white	12,3W	690 lm 6300 K

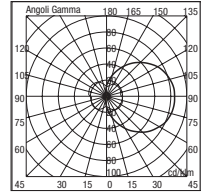
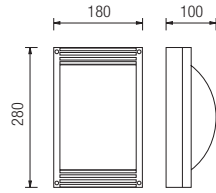

5020 95

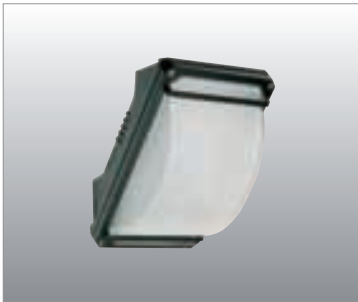

5030

5030.00X		A60	100W	E27
5030.96X		TC-D	18W	G24 d-2
5030.95X		TC-D	26W	G24 d-3
5030.88X		3LED bianco/white	12,3W	690 lm 6300 K

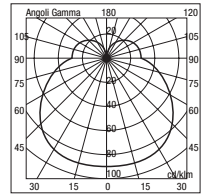
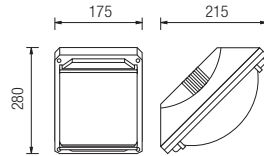

5030 00



DUNE STELO

DUNE STELO



5032 2 luci / 2 lights H 1050



5031 1 luce / 1 light H 950

5031.00X		A60	100W	E27
5031.96X		TC-D	18W	G24 d-2
5031.95X		TC-D	26W	G24 d-3
5031.88X		3LED bianco/white	12,3W	690 lm 6300 K
5032.00X		A60	2x100W	E27
5032.96X		TC-D	2x18W	G24 d-2
5032.95X		TC-D	2x26W	G24 d-3
5032.88X		6LED bianco/white	2x12,3W	2x690 lm 6300 K

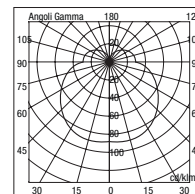

5031 96

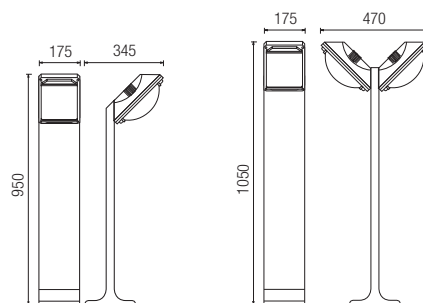

5031

5032



5021 1 luce / 1 light H 980

5022 1 luce / 1 light H 610



5028 2 luci / 2 lights H 980

5021.00X		A60	100W	E27
5021.96X		TC-D	18W	G24 d-2
5021.95X		TC-D	26W	G24 d-3
5021.88X		3LED bianco/white	12,3W	690 lm 6300 K
5022.00X		A60	100W	E27
5022.96X		TC-D	18W	G24 d-2
5022.95X		TC-D	26W	G24 d-3
5022.88X		3LED bianco/white	12,3W	690 lm 6300 K
5028.00X		A60	2x100W	E27
5028.96X		TC-D	2x18W	G24 d-2
5028.95X		TC-D	2x26W	G24 d-3
5028.88X		6LED bianco/white	2x12,3W	2x690 lm 6300 K

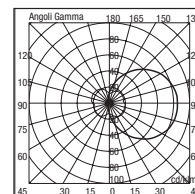

5021 95

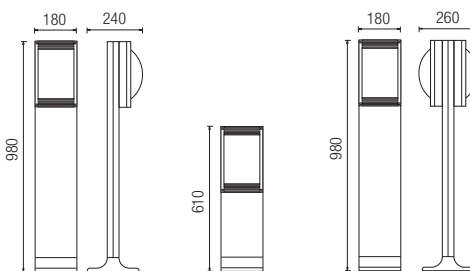

5021

5022

5028







INTRO

INTRO STELO



INTRO

Apparecchio a parete per interni ed esterni costituito da:

- Corpo in alluminio pressofuso
- Diffusore in policarbonato
- Guarnizioni in silicone
- Viti di chiusura in acciaio inox
- Verniciatura in polveri poliestere ad elevata resistenza ai raggi ultravioletti e alla corrosione

Indoor and outdoor wall luminaire constructed of:

- Die-cast aluminium body
- Polycarbonate diffuser
- Silicon gaskets
- Stainless steel screws

INTRO STELO

Piantana per esterni. Costituita da:

- Corpo in alluminio pressofuso verniciato
- Palo in alluminio estruso verniciato
- Diffusore in policarbonato

Outdoor post luminaire constructed of:

- Painted die-cast aluminium body
- Painted extruded aluminium post
- Polycarbonate diffuser
- Painting using high resistance to UV and corrosion polyester powders



IP65 INTRO

IP55 INTRO STELO

Colori - Colours

- X=2 Bianco
White
- X=3 Nero
Black
- X=9 Antracite
Anthracite
- X=4 Silver

Diffusore - Diffuser
Codice-Code 08 7040

Gli apparecchi vengono forniti completi di lampadina
Bulb enclosed to the luminaires

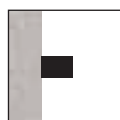

INTRO
Installazione a parete
Wall mounting

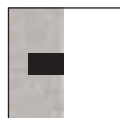

Cod. 7040
Incasso a parete
Recessed wall version

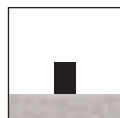

INTRO STELO
Installazione a terra
Floor mounting



7040
La cassaforma deve essere installata a filo muro.
Holder must be recessed flush with the wall surface

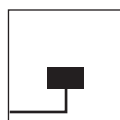

Entrata singola
cavi di alimentazione
Single power supply cables input

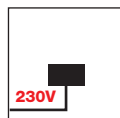

LED - art. 7040.88X - 7041.88X - 7042.88X
Led a tensione di rete 230V 50Hz.
Connessione diretta alla rete di alimentazione senza necessità di trasformatore.
LED's operation at 230V 50Hz voltage directly.
No transformer is required.

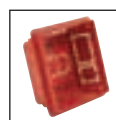

CS 40 per/for 7040
Cassaforma in tecnopolimero 92x92x45 mm
Technopolymer holder 92x92x45 mm

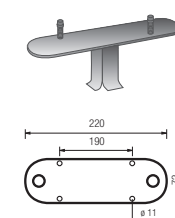

CP 90
ACCESSORIO PER PALO
Controbasse di fissaggio a terra
ACCESSORY FOR POST
Root-mount for ground fixing

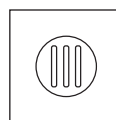

Fluorescente 6W Gx53
Non necessita di alcun alimentatore.
Fluorescent lamp 6W Gx53
Does not need the power supplier

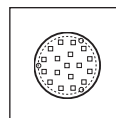

60 LED Gx53
Non necessita di alcun alimentatore.
60 LED Gx53
Does not need the power supplier

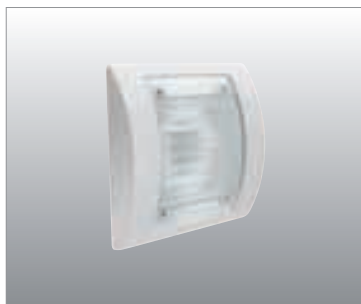

7040

- **7040.60X**  T2 6W Gx53
- **7040.68X**  60LED bianco/white 4W Gx53 260 lm 4000 K
- **7040.88X** 1LED bianco/white 4,1W 230 lm 6300 K

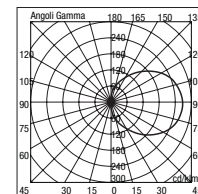
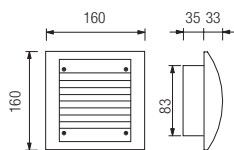

7040 60

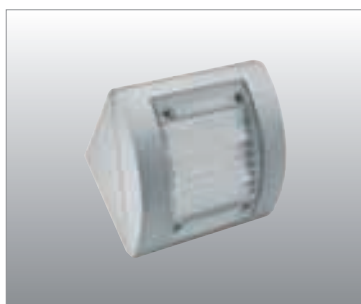

7041

- **7041.60X**  T2 6W Gx53
- **7041.68X**  60LED bianco/white 4W Gx53 260 lm 4000 K
- **7041.88X** 1LED bianco/white 4,1W 230 lm 6300 K

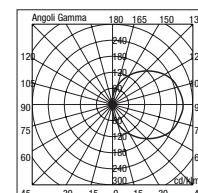
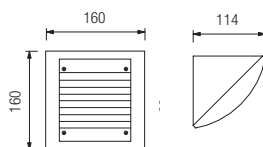

7041 60



7042

- **7042.60X**  T2 6W Gx53
- **7042.68X**  60LED bianco/white 4W Gx53 260 lm 4000 K
- **7042.88X** 1LED bianco/white 4,1W 230 lm 6300 K

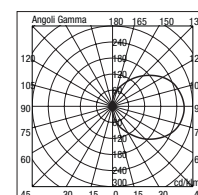
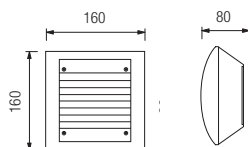

7042 60

- L'apparecchio viene fornito completo di lampadina
Bulb enclosed to the luminaire

INTRO STELO

INTRO STELO



7081 H 600

- **7081.60X** T2 6W Gx53
- **7081.68X** 60LED bianco/white 4W Gx53 260 lm 4000 K
- **7081.88X** 1LED bianco/white 4,1W 230 lm 6300 K

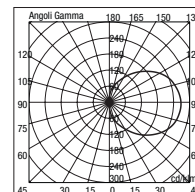
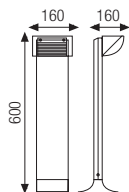

7081 60



7080 H 950

- **7080.60X** T2 6W Gx53
- **7080.68X** 60LED bianco/white 4W Gx53 260 lm 4000 K
- **7080.88X** 1LED bianco/white 4,1W 230 lm 6300 K

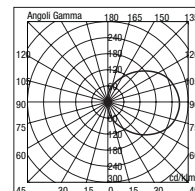
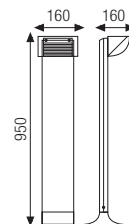

7080 60



7381 doppia / double H 600

- **7381.60X** T2 2x6W Gx53
- **7381.68X** 60LED bianco/white 2x4W Gx53 2x260 lm 4000 K
- **7381.88X** 2LED bianco/white 2x4,1W 2x230 lm 6300 K

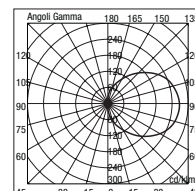
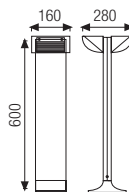

7381 60



7380 doppia / double H 950

- **7380.60X** T2 2x6W Gx53
- **7380.68X** 60LED bianco/white 2x4W Gx53 2x260 lm 4000 K
- **7380.88X** 2LED bianco/white 2x4,1W 2x230 lm 6300 K

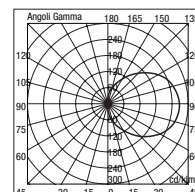
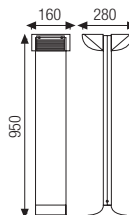

7380 60

- L'apparecchio viene fornito completo di lampadina
Bulb enclosed to the luminaire



7181 H 600

- **7181.60X**  T2 6W Gx53
- **7181.68X**  60LED bianco/white 4W Gx53 260 lm 4000 K
- **7181.88X** 1LED bianco/white 4,1W 230 lm 6300 K

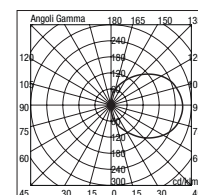
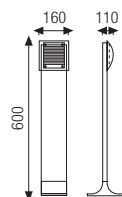

7181 60



7180 H 950

- **7180.60X**  T2 6W Gx53
- **7180.68X**  60LED bianco/white 4W Gx53 260 lm 4000 K
- **7180.88X** 1LED bianco/white 4,1W 230 lm 6300 K

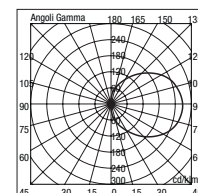
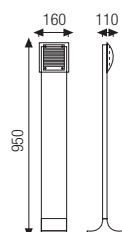

7180 60



7281 doppia / double H 600

- **7281.60X**  T2 2x6W Gx53
- **7281.68X**  60LED bianco/white 2x4W Gx53 2x260 lm 4000 K
- **7281.88X** 2LED bianco/white 2x4,1W 2x230 lm 6300 K

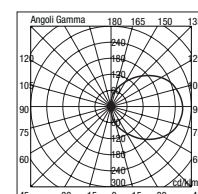
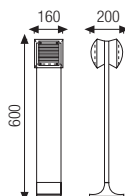

7281 60



7280 doppia / double H 950

- **7280.60X**  T2 2x6W Gx53
- **7280.68X**  60LED bianco/white 2x4W Gx53 2x260 lm 4000 K
- **7280.88X** 2LED bianco/white 2x4,1W 2x230 lm 6300 K

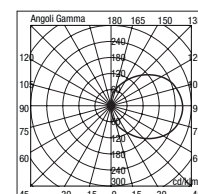
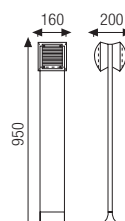

7280 60

- L'apparecchio viene fornito completo di lampadina
Bulb enclosed to the luminaire

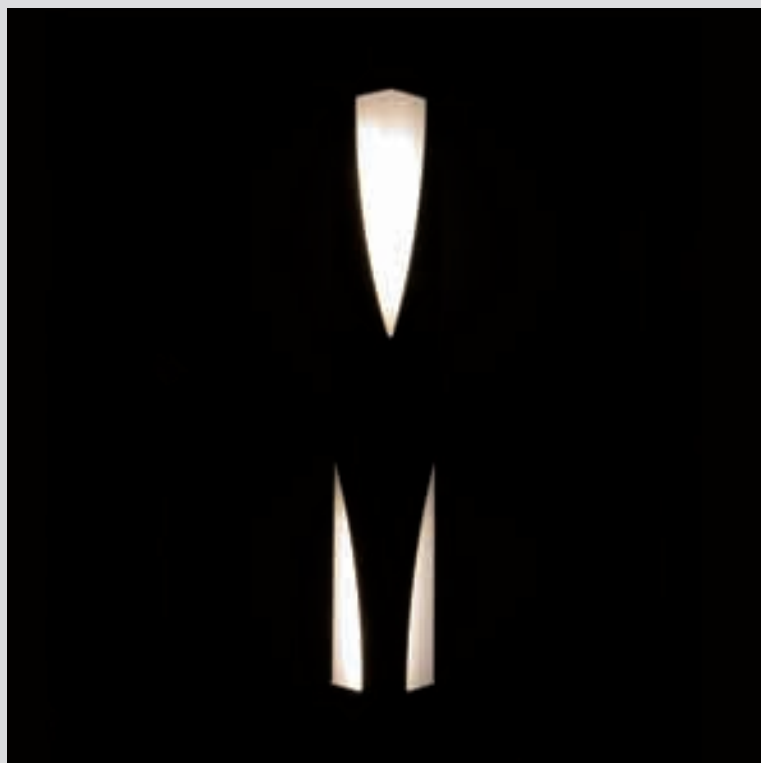



SKA

SKA

Apparecchio per illuminazione di esterni costituito da:

- Palo in alluminio estruso verniciato
- Base e chiusura in alluminio pressofuso verniciato
- Diffusore in policarbonato
- Guarnizione in silicone
- Viti di chiusura in acciaio inox
- Verniciatura in polveri poliestere ad elevata resistenza ai raggi ultravioletti e alla corrosione

Outdoor luminaire constructed of:

- Painted extruded aluminium post
- Painted die-cast aluminium base and cap
- Polycarbonate diffuser
- Silicon gasket
- Stainless steel screws
- Painting using high resistance to UV and corrosion polyester powders



Colori - Colours

X=2 Bianco
White

X=3 Nero
Black

X=9 Antracite
Anthracite

X=4 Silver

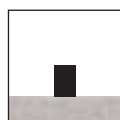

Installazione a terra
Floor mounting



Diffusore - Diffuser

Codice-Code 08 1800

per/for Cod. 1800 - 1840

Codice-Code 08 1801

per/for Cod. 1801 - 1841

Le lampadine vengono fornite solo su richiesta

Bulbs supplied only
on request



1800 H 1000



1801 H 600

4 fasci luminosi - 4 light beams
1800.99X  TC-L 2x24W 2G11

2 fasci luminosi - 2 light beams
1801.99X  TC-L 1x24W 2G11

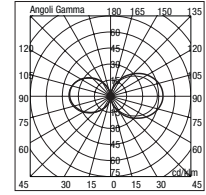
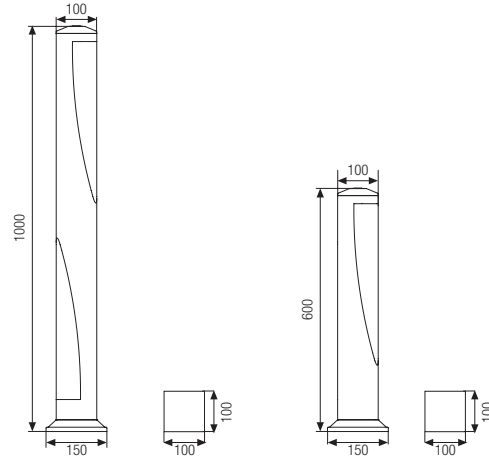

1800 99

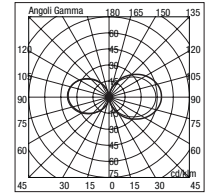

1801 99

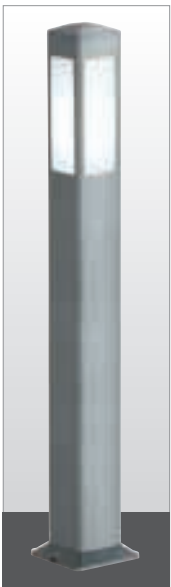

1840 H 1000



1841 H 600

4 fasci luminosi - 4 light beams
1840.99X  TC-L 24W 2G11

1841.99X  TC-L 24W 2G11

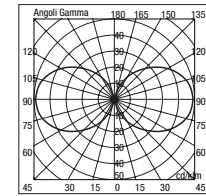
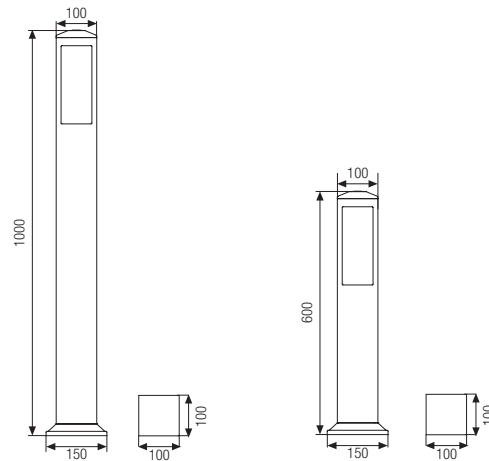

1840 99

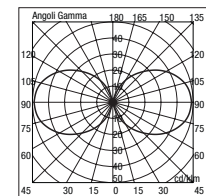

1841 99

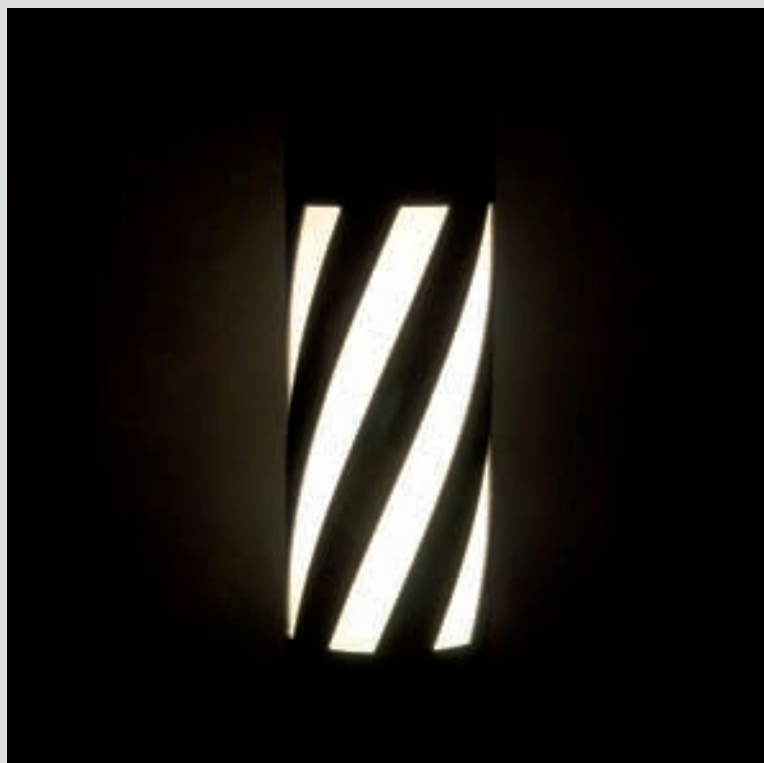



TWIST

TWIST

Apparecchio per illuminazione di esterni costituito da:

- Palo in alluminio estruso verniciato
- Base e chiusura in alluminio pressofuso verniciato
- Diffusore in policarbonato
- Guarnizione in silicone
- Viti di chiusura in acciaio inox
- Verniciatura in polveri poliestere ad elevata resistenza ai raggi ultravioletti e alla corrosione

Outdoor luminaire constructed of:

- Painted extruded aluminium post
- Painted die-cast aluminium base and cap
- Polycarbonate diffuser
- Silicon gasket
- Stainless steel screws
- Painting using high resistance to UV and corrosion polyester powders



Colori - Colours

X=2 Bianco
White

X=3 Nero
Black

X=9 Antracite
Anthracite

X=4 Silver

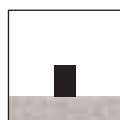

Installazione a terra
Floor mounting



Diffusore - Diffuser

TWIST MINI

08 1580 per/for 1580 -1380

08 1581 per/for 1581 -1381

TWIST BIG

08 1680 per/for 1680

08 1681 per/for 1681

Le lampadine vengono fornite solo su richiesta

Bulbs supplied only on request

TWIST MINI

TWIST MINI



1580

1580.99X  TC-L 24W 2G11

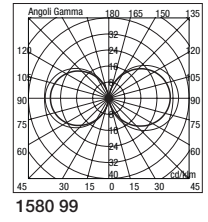
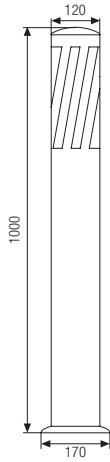

1580 99



1581

1581.99X  TC-L 24W 2G11

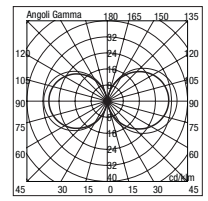
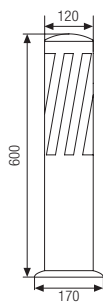

1581 99

TWIST MINI

TWIST MINI



1380

1380.99X  TC-L 24W 2G11

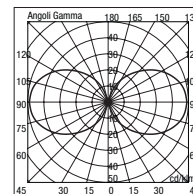
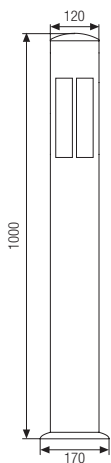

1380 99



1381

1381.99X  TC-L 24W 2G11

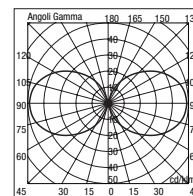
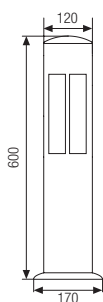

1381 99

TWIST BIG

TWIST BIG



1680

1680.94X  TC-L 36W 2G11

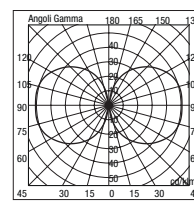
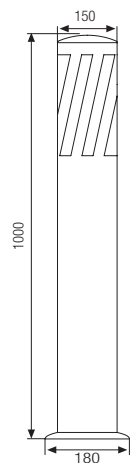

1680 94



1681

1681.94X  TC-L 36W 2G11

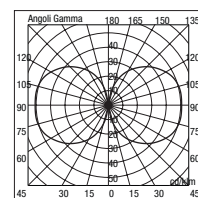
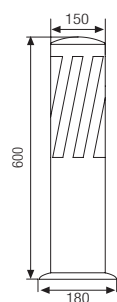

1681 94





LUNA

LUNA

Apparecchio per illuminazione di esterni a una o a due uscite di luce. È disponibile in due dimensioni Ø 80 e Ø 120 e in diverse altezze costituito da:

- Base e chiusura in alluminio pressofuso verniciato
- Palo in alluminio estruso verniciato
- Diffusore in policarbonato
- Viti di chiusura in acciaio inox
- Verniciatura in polveri poliestere ad elevata resistenza ai raggi ultravioletti e alla corrosione

Outdoor luminaire with 1 or 2 light openings. Available in Ø 80 and Ø 120.

Available in different heights constructed of:

- Painted die-cast aluminium base and cap
- Painted extruded aluminium post
- Polycarbonate diffuser
- Silicon gaskets
- Stainless steel screws
- Painting using high resistance to UV and corrosion polyester powders

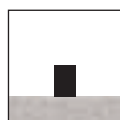

Installazione a terra
Floor mounting



Colori - Colours

- X=2 Bianco
White
- X=3 Nero
Black
- X=9 Antracite
Anthracite
- X=4 Silver

Diffusore - Diffuser

Codice-Code 08 2610

per/for Cod. 2610 - 2616

Codice-Code 08 2611

per/for Cod. 2611 - 2618

Codice-Code 08 2614

per/for Cod. 2614 - 2615

Codice-Code 08 2612

per/for Cod. 2612 - 2619

Le lampadine vengono fornite solo su richiesta

Bulbs supplied only on request



Per/for LUNA MINI
ACCESSORIO: art. CP 26
Supporto orientabile con picchetto in alluminio pressofuso.
Die-cast aluminium directional fixing bracket with spike.



Versione in biemissione
Double-light version

LUNA MINI



2616

2616.99X  TC-L 24W 2G11

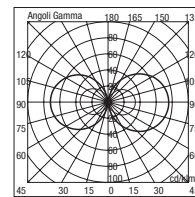
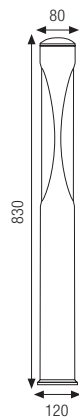

2616 99

LUNA MINI

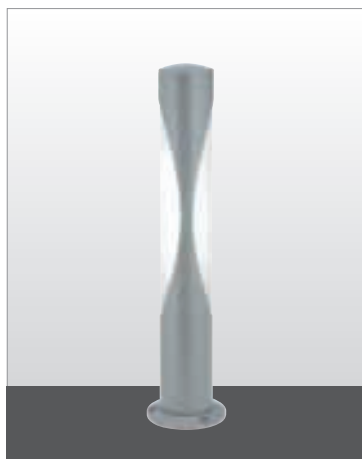

2618

2618.98X  TC-L 18W 2G11

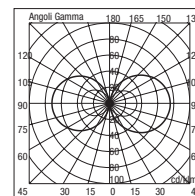
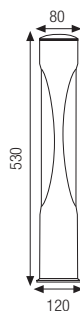

2618 98

LUNA MINI

LUNA MINI

Versione in monoemissione
Mono-light version



2610

2610.99X  TC-L 24W 2G11

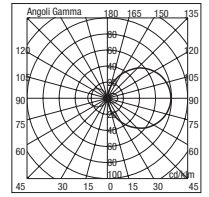

2610 99

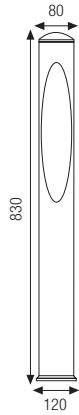

2611

2611.98X  TC-L 18W 2G11

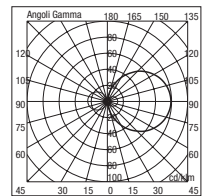

2611 98



Versione in biemissione
Double-light version



2614 H 1000
2612 H 650

2614.94X  TC-L 36W 2G11

2612.99X  TC-L 24W 2G11

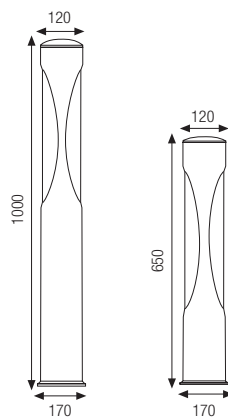

LUNA BIG

LUNA BIG

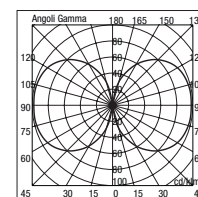



2614 94

Versione in monoemissione
Mono-light version



2615 H 1000
2619 H 650

2615.94X  TC-L 36W 2G11

2619.99X  TC-L 24W 2G11

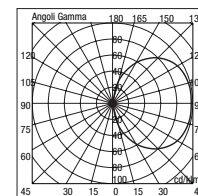
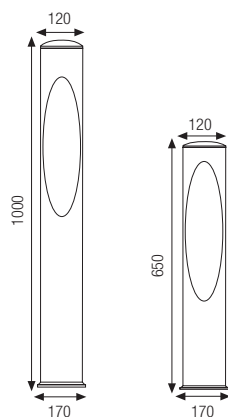

2615 94

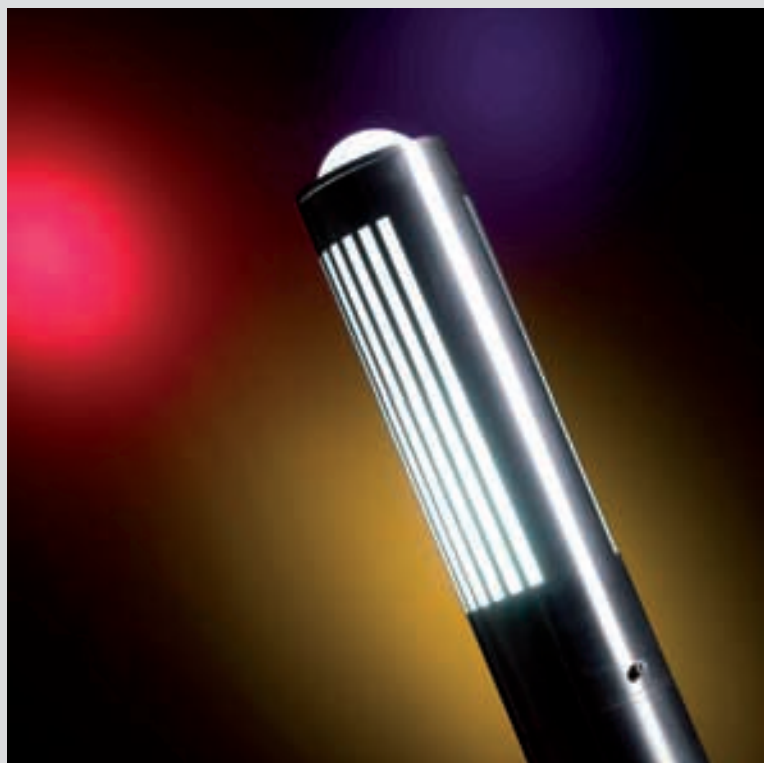



ARES INOX

ARES INOX

Apparecchio per illuminazione di esterni costituito da:

- Struttura interamente in acciaio inox AISI 316
- Diffusore in policarbonato
- Guarnizioni in silicone
- Viti di chiusura in acciaio inox

Outdoor luminaire constructed of:

- Entirely stainless steel AISI 316 structure
- Opal polycarbonate diffuser
- Silicon gaskets
- Stainless steel screws



Diffusore - Diffuser
Codice-Code 08 2030

Le lampadine vengono fornite solo su richiesta
Bulbs supplied only on request

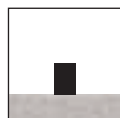

Installazione a terra
Floor mounting



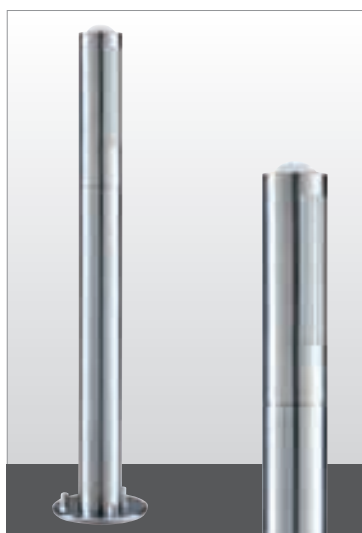

2032 H 900 1 apertura
2034 H 580 1 opening

2032.950		TC-D	26W	G24 d-3
2034.950		TC-D	26W	G24 d-3

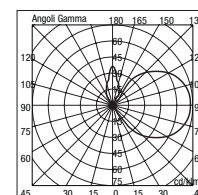
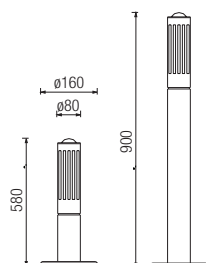

2032 95



2030 H 900 2 aperture
2036 H 580 2 openings

2030.950		TC-D	26W	G24 d-3
2036.950		TC-D	26W	G24 d-3

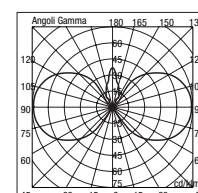
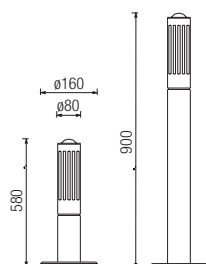

2030 95

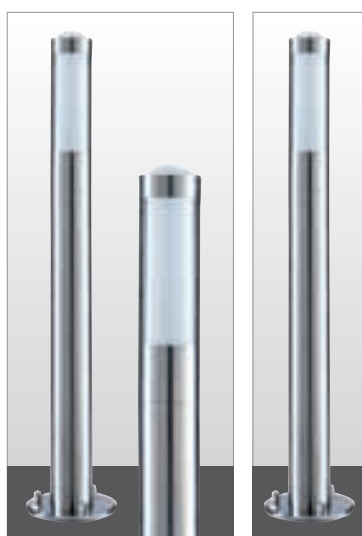

2031 H 900
2035 H 580
 2 apertura
 2 opening

2039 H 900
2037 H 580
 1 apertura
 1 opening

2031.950		TC-D	26W	G24 d-3
2035.950		TC-D	26W	G24 d-3
2039.950		TC-D	26W	G24 d-3
2037.950		TC-D	26W	G24 d-3

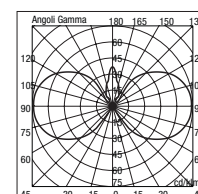
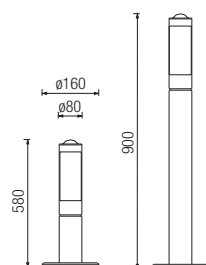

2031 95





STICK



RAY



STICK

Apparecchio per illuminazione di esterni costituito da:

- Palo in alluminio estruso verniciato
- Diffusore in policarbonato trasparente
- Guarnizione in EPDM
- Viti di chiusura in acciaio inox
- Verniciatura in polveri poliestere ad elevata resistenza ai raggi ultravioletti e alla corrosione

Outdoor luminaire constructed of:

- Painted extruded aluminium post
- Transparent polycarbonate diffuser
- EPDM gasket
- Stainless steel screws
- Painting using high resistance to UV and corrosion polyester powders



Colori - Colours

X=2  Bianco
White

X=3  Nero
Black

X=9  Antracite
Anthracite

X=4  Silver

Diffusore - Diffuser

Codice-Code 08 3011
trasparente/transparent

**Le lampadine vengono fornite
solo su richiesta**

Bulbs supplied only
on request



3011 - 3015
Installazione a terra
Floor mounting

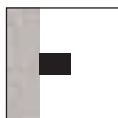

3017
Installazione a muro
Wall mounting

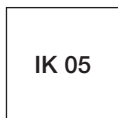



3017

3017.91X		TC	11W	G23
3017.96X		TC-D	18W	G24 d-2

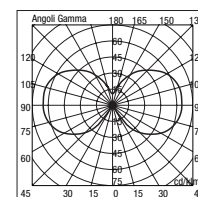
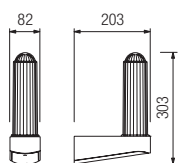

3017 96

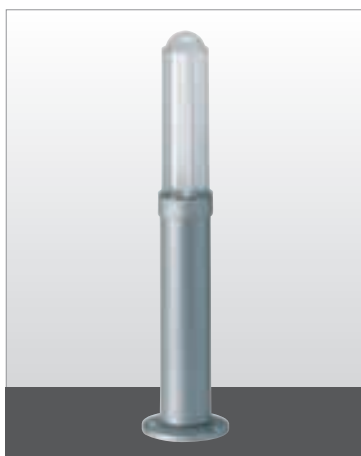

3011 H 550

3011.91X		TC	11W	G23
3011.96X		TC-D	18W	G24 d-2

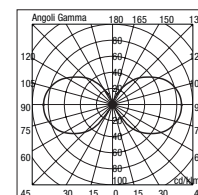
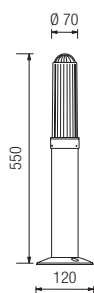

3011 91



3015 H 1000

3015.91X		TC	11W	G23
3015.96X		TC-D	18W	G24 d-2

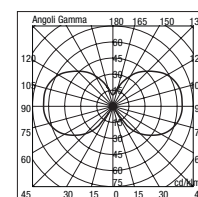
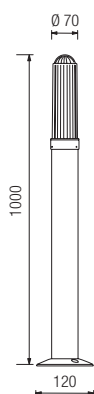

3015 96

RAY

Apparecchio per illuminazione di esterni costituito da:



- Palo in alluminio estruso verniciato
- Struttura superiore in alluminio pressofuso verniciato
- Diffusore in policarbonato
- Guarnizione in silicone
- Viti di chiusura in acciaio inox
- Verniciatura in polveri poliestere ad elevata resistenza ai raggi ultravioletti e alla corrosione

Outdoor luminaire constructed of:

- Painted extruded aluminium post
- Painted die-cast aluminium head
- Polycarbonate diffuser
- Silicon gasket
- Stainless steel screws
- Painting using high resistance to UV and corrosion polyester powders



Colori - Colours

- X=3  Nero
Black
- X=9  Antracite
Anthracite
- X=4  Silver

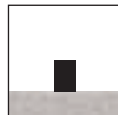

2810-2811
Installazione a terra
Floor mounting

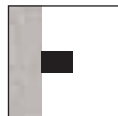

2812
Installazione a muro
Wall mounting

Diffusore - Diffuser
Codice-Code 08 2810



Le lampadine vengono fornite solo su richiesta
Bulbs supplied only on request





2812

Apparecchio a parete
in alluminio pressofuso
Die-cast aluminium wall luminaire

2812.00X		A60	60W	E27
2812.96X		TC-D	18W	G24 d-2

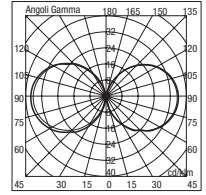
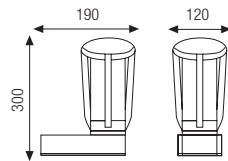

2812 96

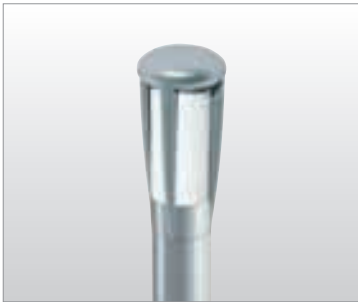

2811 H 700

2811.00X		A60	60W	E27
2811.96X		TC-D	18W	G24 d-2

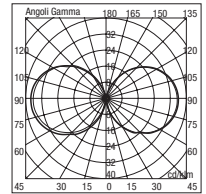
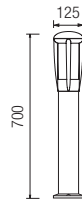

2811 96



2810 H 1000

2810.00X		A60	60W	E27
2810.96X		TC-D	18W	G24 d-2

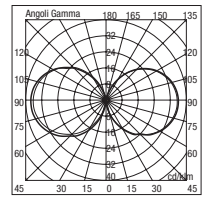
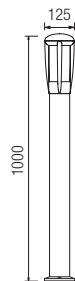

2810 96





BLOB



BLOB

Apparecchio per illuminazione di esterni a luce diretta o indiretta costituito da:

- Palo in alluminio estruso verniciato
- Struttura superiore in alluminio pressofuso verniciato
- Diffusore in policarbonato opale per Blob e trasparente per Blob 2
- Guarnizioni in silicone
- Viti di chiusura in acciaio inox
- Verniciatura in polveri poliestere ad elevata resistenza ai raggi ultravioletti ed alla corrosione

Outdoor and indoor direct or indirect light luminaire constructed of:

- Painted extruded aluminium post
- Die-cast aluminium painted head
- Opal polycarbonate diffuser for Blob and transparent polycarbonate diffuser for Blob 2
- Silicon gaskets
- Stainless steel screws
- Painting using high resistance to UV and corrosion polyester powders



8030 - 8034 - 8032 - 8031
8130 - 8131 - 8132 - 8134
Installazione a terra
Floor mounting

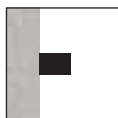

8033 - 8133
Installazione a muro
Wall mounting



Direttiva/Directive

EuP/ErP (2005/52/CE-2009/125/CE)

Gli apparecchi per lampade a scarica ad alta intensità sono progettati per lampade chiare e opali.

Luminaires for high intensity discharge lamps are designed for either clear and coated lamps.

Colori - Colours

X=3  Nero
Black

X=9  Antracite
Anthracite

X=4  Silver

Diffusore - Diffuser

Codice-Code 08 8030

per/for Cod. 8030 - 8034

Codice-Code 08 8033

per/for Cod. 8031 - 8032 - 8033

Codice-Code 08 8130

per/for Cod. 8130 - 8134

Codice-Code 08 8133

per/for Cod. 8131 - 8132 - 8133

Le lampadine vengono fornite solo su richiesta

Bulbs supplied only on request

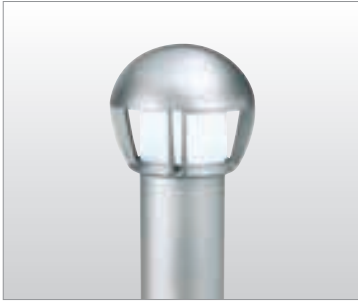

8034 H 600

8034.00X		A60	75W	E27
8034.95X		TC-D	26W	G24 d-3
8034.35X		HIT	35W	G12

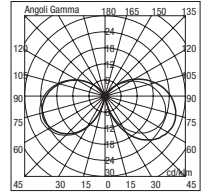
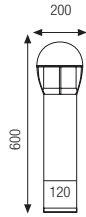

8034 95



8030 H 1050

8030.00X		A60	75W	E27
8030.95X		TC-D	26W	G24 d-3
8030.35X		HIT	35W	G12

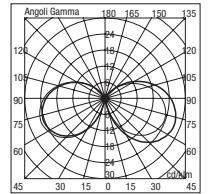
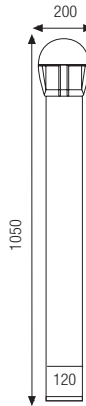

8030 95



BLOB

BLOB

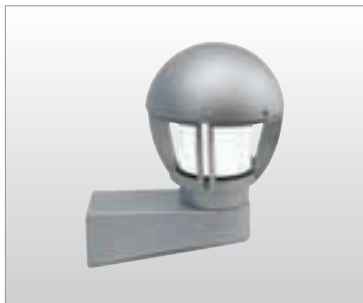

8033

Apparecchio a parete
in alluminio pressofuso
Die-cast aluminium wall luminaire

8033.00X		A60	60W	E27
8033.84X		TC-T	18W	GX24 d-2

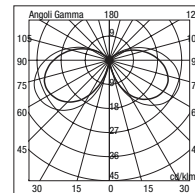
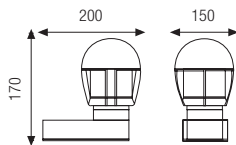

8033 84

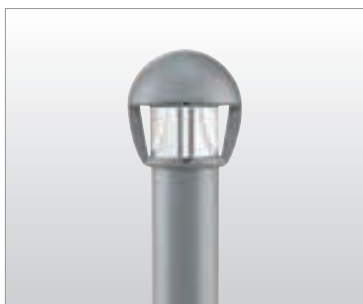

8031 H 600

8031.00X		A60	60W	E27
8031.84X		TC-T	18W	GX24 d-2

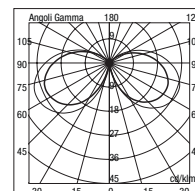
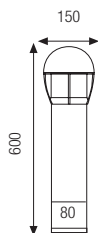

8031 84



8032 H 900

8032.00X		A60	60W	E27
8032.84X		TC-T	18W	GX24 d-2

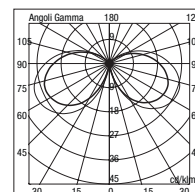
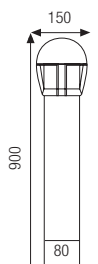

8032 84

Apparecchio a luce indiretta.

In Blob 2 la luce irradiata dalla sorgente subisce una riflessione indiretta diffusa e intensa.

Indirect light luminaire.

In Blob 2 the light irradiating from the source has a diffuse and intense reflection.



8133

8133.84X  TC-T 18W GX24 d-2

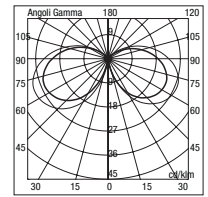
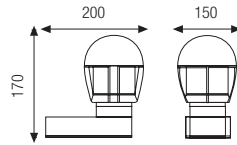



8133 84



8131 H 600

8132 H 900

8131.84X  TC-T 18W GX24 d-2

8132.84X  TC-T 18W GX24 d-2

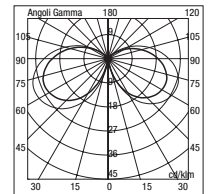
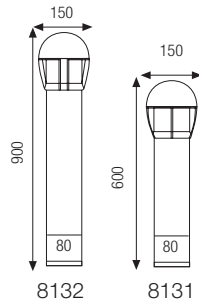



8131 84





8130 H 1050

8134 H 600

8130.95X  TC-D 26W G24 d-3

8130.35X  HIT 35W G12

8134.95X  TC-D 26W G24 d-3

8134.35X  HIT 35W G12

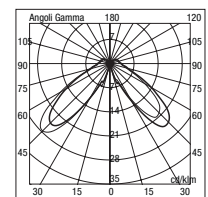
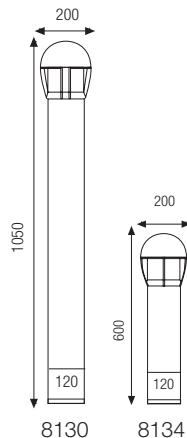

8130 95





ARGO

ARGO

Apparecchio per illuminazione di esterni costituito da:

- Palo in alluminio estruso verniciato
- Struttura superiore in alluminio pressofuso verniciato
- Diffusore in policarbonato
- Guarnizione in silicone
- Viti di chiusura in acciaio inox
- Verniciatura in polveri poliestere ad elevata resistenza ai raggi ultravioletti e alla corrosione

Outdoor luminaire constructed of:

- Painted extruded aluminium post
- Painted die-cast aluminium head
- Polycarbonate diffuser
- Silicon gasket
- Stainless steel screws
- Painting using high resistance to UV and corrosion polyester powders



Colori - Colours

X=3  Nero
Black

X=9  Antracite
Anthracite

X=4  Silver

Diffusore - Diffuser

Codice-Code 08 2100

Policarbonato/Polycarbonate

Le lampadine vengono fornite solo su richiesta

Bulbs supplied only on request

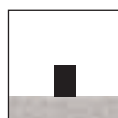

Installazione a terra
Floor mounting



Direttiva/Directive
EuP/ErP (2005/52/CE-2009/125/CE)

Gli apparecchi per lampade a scarica ad alta intensità sono progettati per lampade chiare e opali.

Luminaires for high intensity discharge lamps are designed for either clear and coated lamps.



2102 H 550

2102.00X		A60	100W	E27
2102.95X		TC-D	26W	G24 d-3
2102.81X		TC-TEL 26-32-42W		GX24 q-3-4
Con reattore elettronico / With electronic ballast				
2102.35X		HIT	35W	G12

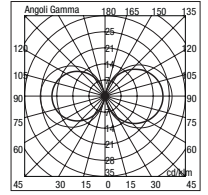
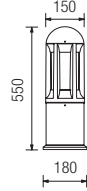

2102 81



2101 H 710

2101.00X		A60	100W	E27
2101.95X		TC-D	26W	G24 d-3
2101.81X		TC-TEL 26-32-42W		GX24 q-3-4
Con reattore elettronico / With electronic ballast				
2101.35X		HIT	35W	G12

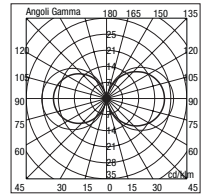
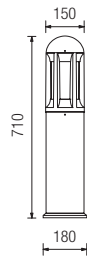

2101 81



2100 H 1160

2100.00X		A60	100W	E27
2100.95X		TC-D	26W	G24 d-3
2100.81X		TC-TEL 26-32-42W		GX24 q-3-4
Con reattore elettronico / With electronic ballast				
2100.35X		HIT	35W	G12

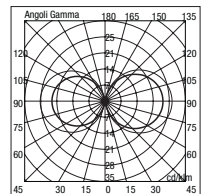

2100 81





LEXUS

LEXUS

Apparecchio per illuminazione di esterni a luce indiretta costituito da:

- Palo in alluminio estruso verniciato
- Struttura superiore in alluminio pressofuso verniciato
- Diffusore in vetro temperato
- Parabola riflettente in alluminio
- Guarnizione in silicone
- Viti di chiusura in acciaio inox
- Verniciatura in polveri poliestere ad elevata resistenza ai raggi ultravioletti e alla corrosione

Indirect light outdoor luminaire constructed of:

- Painted extruded aluminium post
- Painted die-cast aluminium head
- Tempered glass diffuser
- Aluminium reflector
- Silicon gasket
- Stainless steel screws
- Painting using high resistance to UV and corrosion polyester powders



Colori - Colours

X=3 Nero
Black

X=9 Antracite
Anthracite

X=4 Silver

Diffusore - Diffuser

Codice-Code 05 4011

Vetro/Glass

Le lampadine vengono fornite solo su richiesta

Bulbs supplied only on request

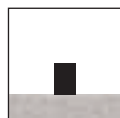

Installazione a terra
Floor mounting

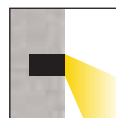

L'emissione di luce verso il basso è nel pieno rispetto delle leggi contro l'inquinamento luminoso.

The direct light emission is in full compliance with standard light pollution directives

Direttiva/Directive

EuP/ErP (2005/52/CE-2009/125/CE)

Gli apparecchi per lampade a scarica ad alta intensità sono progettati per lampade chiare e opali.

Luminaires for high intensity discharge lamps are designed for either clear and coated lamps.





2401 H 530

2401.83X		TC-T	26W	GX24 d-3
2401.35X		HIT	35W	G12

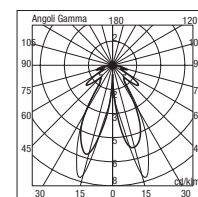
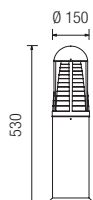

2401 83



2400 H 730

2400.83X		TC-T	26W	GX24 d-3
2400.35X		HIT	35W	G12

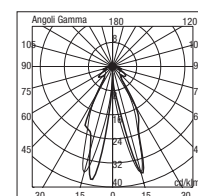
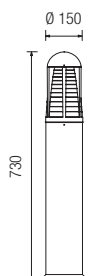

2400 35





ZEUS



ARES



ARES 2

ZEUS

Apparecchio per illuminazione di esterni costituito da:

- Palo in alluminio estruso verniciato
- Struttura superiore in alluminio pressofuso verniciato
- Diffusore in policarbonato o in vetro
- Guarnizione in silicone
- Viti di chiusura in acciaio inox
- Verniciatura in polveri poliestere ad elevata resistenza ai raggi ultravioletti e alla corrosione

Outdoor luminaire constructed of:

- Painted extruded aluminium post
- Painted die-cast aluminium head
- Polycarbonate diffuser
- Silicon gasket
- Stainless steel screws
- Painting using high resistance to UV and corrosion polyester powders



Colori - Colours

X=2  Bianco
White

X=3  Nero
Black

X=9  Antracite
Anthracite

X=4  Silver

Diffusore - Diffuser

Codice-Code 00 2000 Vetro/Glass

Codice-Code 08 2000

Policarbonato/Polycarbonate

Codice-Code 08 2009

Policarbonato/Polycarbonate
per-for Cod. 2009

Le lampadine vengono fornite solo su richiesta ad eccezione della versione T2 6W-60 LED Gx53

Bulbs supplied only on request except for T2 6W-60 LED Gx53 version

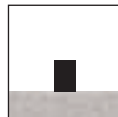

Installazione a terra
Floor mounting

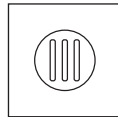

Fluorescente 6W Gx53
Non necessita di alcun alimentatore.
Fluorescent lamp 6W Gx53
Does not need the power supplier

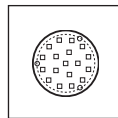

60 LED Gx53
Non necessita di alcun alimentatore.
60 LED Gx53
Does not need the power supplier

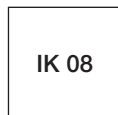

diffusore vetro
glass diffuser



diffusore policarbonato
polycarbonate diffuser

Direttiva/Directive
EuP/ErP (2005/52/CE-2009/125/CE)
Gli apparecchi per lampade a scarica ad alta intensità sono progettati per lampade chiare e opali.
Luminaires for high intensity discharge lamps are designed for either clear and coated lamps.



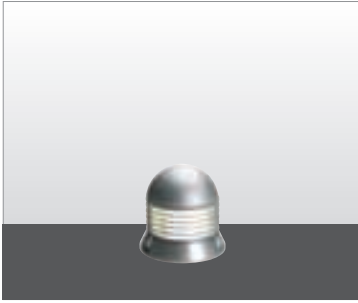

2009 H 175

2009.14X		QT14 Halopin	40W	G9	230V	diff. Polic./Polyc. diff.
2009.60X		T2	6W	Gx53		diff. Polic./Polyc. diff.
2009.68X		60LED bianco/white	4W	Gx53	260 lm	4000 K

- L'apparecchio viene fornito completo di lampadina
Bulb enclosed to the luminaire

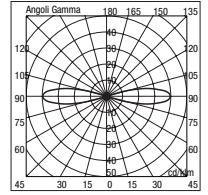
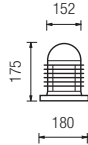

2009 14



2003 H 500
2004 H 650

2003.00X		A60	100W	E27		diff. Polic./Polyc. diff.
2003.35X		HIT	35W	G12		diff. Vetro/Glass diff.
2003.83X		TC-T	26W	GX24 d-3		diff. Polic./Polyc. diff.
2003.71X		HME	80W	E27		diff. Vetro/Glass diff.
2004.00X		A60	100W	E27		diff. Polic./Polyc. diff.
2004.35X		HIT	35W	G12		diff. Vetro/Glass diff.
2004.83X		TC-T	26W	GX24 d-3		diff. Polic./Polyc. diff.
2004.71X		HME	80W	E27		diff. Vetro/Glass diff.

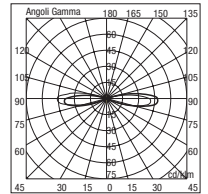
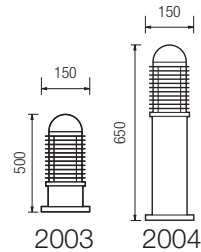

2003 00



2008 H 1100

2008.00X		A60	100W	E27		diff. Polic./Polyc. diff.
2008.35X		HIT	35W	G12		diff. Vetro/Glass diff.
2008.83X		TC-T	26W	GX24 d-3		diff. Polic./Polyc. diff.
2008.71X		HME	80W	E27		diff. Vetro/Glass diff.

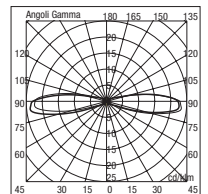

2008 83

ARES

Apparecchio per illuminazione di esterni costituito da:

- Palo in alluminio estruso verniciato
- Struttura superiore in alluminio pressofuso verniciato
- Diffusore in vetro pirex satinato o in policarbonato
- Guarnizioni in silicone
- Viti di chiusura in acciaio inox
- Verniciatura in polveri poliesteri ad elevata resistenza ai raggi ultravioletti e alla corrosione

Outdoor luminaire constructed of:

- Painted extruded aluminium post
- Painted die-cast aluminium head
- Satin pyrex or polycarbonate diffuser
- Silicon gaskets
- Stainless steel screws
- Painting using high resistance to UV and corrosion polyester powders



Colori - Colours

X=2 Bianco
White

X=3 Nero
Black

X=9 Antracite
Anthracite

X=4 Silver

Diffusore - Diffuser

Codice-Code 00 2000 Vetro/Glass

Codice-Code 08 2000

Policarbonato/Polycarbonate

Le lampadine vengono fornite solo su richiesta

Bulbs supplied only on request



Installazione a terra
Floor mounting

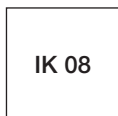

diffusore vetro
glass diffuser



diffusore policarbonato
polycarbonate diffuser

Direttiva/Directive
EuP/ErP (2005/52/CE-2009/125/CE)

Gli apparecchi per lampade a scarica ad alta intensità sono progettati per lampade chiare e opali.

Luminaires for high intensity discharge lamps are designed for either clear and coated lamps.



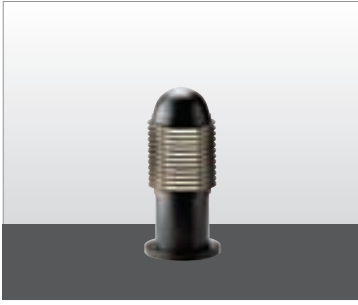

2002 H 500

2002.00X		A60	100W	E27
Diffusore policarbonato / Polycarbonate diffuser				
2002.71X		HME	80W	E27
Diffusore vetro / Glass diffuser				
2002.83X		TC-T	26W	GX24 d-3
Diffusore policarbonato / Polycarbonate diffuser				

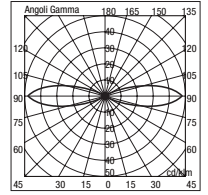
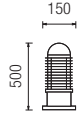

2002 00

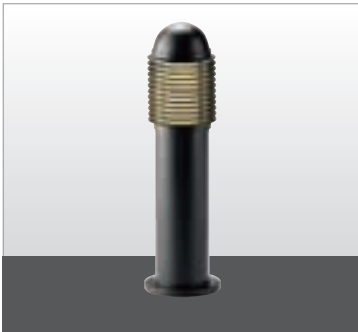

2001 H 650

2001.00X		A60	100W	E27
Diffusore policarbonato / Polycarbonate diffuser				
2001.71X		HME	80W	E27
Diffusore vetro / Glass diffuser				
2001.83X		TC-T	26W	GX24 d-3
Diffusore policarbonato / Polycarbonate diffuser				

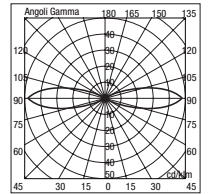
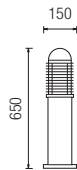

2001 00



2000 H 1100

2000.00X		A60	100W	E27
Diffusore policarbonato / Polycarbonate diffuser				
2000.71X		HME	80W	E27
Diffusore vetro / Glass diffuser				
2000.83X		TC-T	26W	GX24 d-3
Diffusore policarbonato / Polycarbonate diffuser				

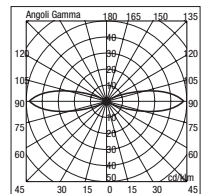

2000 00

ARES 2

Apparecchio per illuminazione di esterni costituito da:

- Palo in alluminio estruso verniciato
- Struttura superiore in alluminio pressofuso verniciato
- Puntalino superiore in policarbonato trasparente
- Diffusore in vetro pirex sabbatiato o in policarbonato
- Guarnizioni in silicone
- Viti di chiusura in acciaio inox
- Verniciatura in polveri poliestere ad elevata resistenza ai raggi ultravioletti e alla corrosione

Outdoor luminaire constructed of:

- Painted extruded aluminium post
- Painted die-cast aluminium head
- Transparent polycarbonate cap
- Sandblasted Pyrex or polycarbonate diffuser
- Silicon gaskets
- Stainless steel screws
- Painting using high resistance to UV and corrosion polyester powders



Colori - Colours

X=2 Bianco
White

X=3 Nero
Black

X=4 Silver

Diffusore - Diffuser

Codice-Code 00 2000 Vetro/Glass

Codice-Code 08 2000

Polycarbonato/Polycarbonate

Le lampadine vengono fornite solo su richiesta

Bulbs supplied only on request

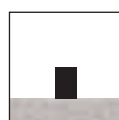

Installazione a terra
Floor mounting



diffusore vetro
glass diffuser



diffusore policarbonato
polycarbonate diffuser

Direttiva/Directive
EuP/ErP (2005/52/CE-2009/125/CE)

Gli apparecchi per lampade a scarica ad alta intensità sono progettati per lampade chiare e opali.

Luminaires for high intensity discharge lamps are designed for either clear and coated lamps.

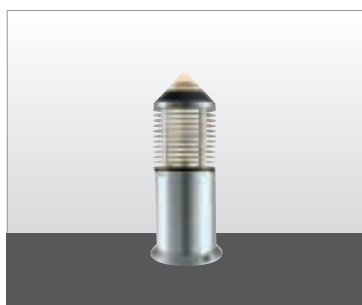

2005 H 530

2005.00X		A60	100W	E27	diff. Polic./Polyc. diff.
2005.71X		HME	80W	E27	diff. Vetro/Glass diff.
2005.95X		TC-D	26W	G24 d-3	diff. Polic./Polyc. diff.

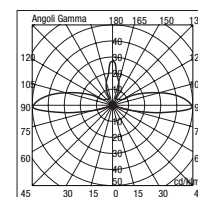
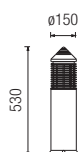

2005 95

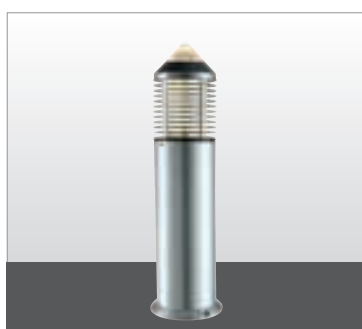

2006 H 670

2006.00X		A60	100W	E27	diff. Polic./Polyc. diff.
2006.71X		HME	80W	E27	diff. Vetro/Glass diff.
2006.95X		TC-D	26W	G24 d-3	diff. Polic./Polyc. diff.

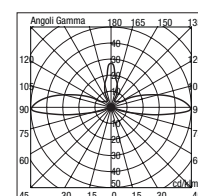
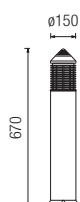

2006 95



2007 H 1120

2007.00X		A60	100W	E27	diff. Polic./Polyc. diff.
2007.71X		HME	80W	E27	diff. Vetro/Glass diff.
2007.95X		TC-D	26W	G24 d-3	diff. Polic./Polyc. diff.

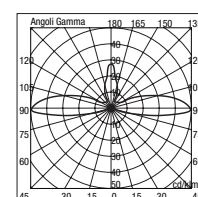
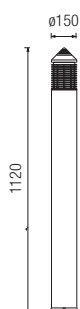

2007 95





AIRONE

AIRONE STELO



AIRONE

Apparecchio per interni ed esterni costituito da:

- Corpo in alluminio pressofuso verniciato
- Diffusore in policarbonato
- Parabola riflettente in alluminio
- Guarnizioni in EPDM
- Viti di chiusura in acciaio inox
- Verniciatura in polveri poliestere ad elevata resistenza ai raggi ultravioletti e alla corrosione

Indoor and outdoor luminaire constructed of:

- Painted die-cast aluminium body
- Polycarbonate diffuser
- Aluminium reflector
- EPDM gaskets
- Stainless steel screws
- Painting using high resistance to UV and corrosion polyester powders



AIRONE STELO

- Palo in alluminio estruso
- Corpo in alluminio pressofuso
- Diffusore in policarbonato
- Su richiesta controbases di fissaggio a terra CP 90

- Extruded aluminium post
- Painted die-cast aluminium structure
- Polycarbonate diffuser
- Root mount for pedestal luminaire ground fixing CP 90 on request



Colori - Colours

X=2 Bianco
White

X=3 Nero
Black

X=9 Antracite
Anthracite

X=4 Silver

Diffusore - Diffuser

Codice-Code 08 9040

Policarbonato/Polycarbonate

Le lampadine vengono fornite solo su richiesta

Bulbs supplied only on request

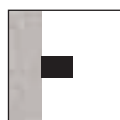

AIRONE
Installazione a parete
Wall mounting



AIRONE STELO
Installazione a terra
Floor mounting

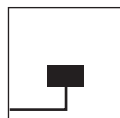

Entrata singola
cavi di alimentazione
Single power supply
cables input

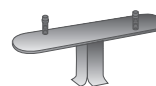

CP 90
ACCESSORIO PER PALO
Controbases di fissaggio a terra
ACCESSORY FOR POST
Root-mount for ground fixing

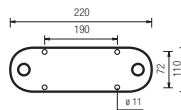



9040

9040.00X		A60	75W	E27
9040.96X		TC-D	18W	G24 d-2

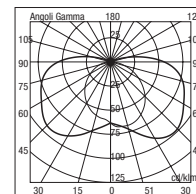
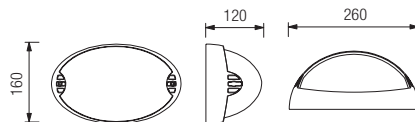

9040 96



9041

9041.00X		A60	75W	E27
9041.96X		TC-D	18W	G24 d-2

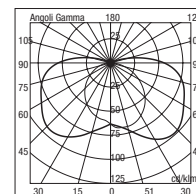
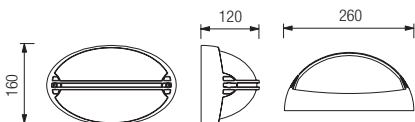

9041 96



9042

9042.00X		A60	75W	E27
9042.96X		TC-D	18W	G24 d-2

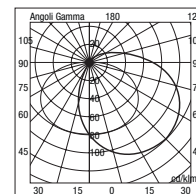
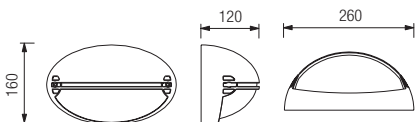

9042 00



9039

9039.00X		A60	75W	E27
9039.96X		TC-D	18W	G24 d-2

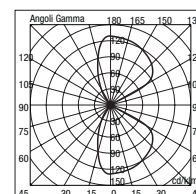
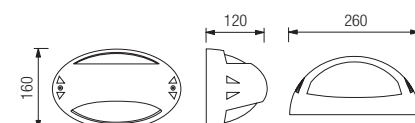

9039 96

AIRONE

AIRONE



9043

9043.00X		A60	75W	E27
9043.96X		TC-D	18W	G24 d-2

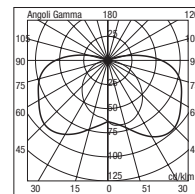
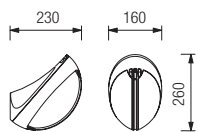

9043 96



9044

9044.00X		A60	75W	E27
9044.96X		TC-D	18W	G24 d-2

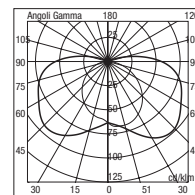
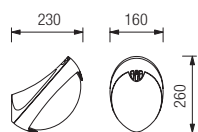

9044 96



9046 H 1020

9045 H 650

9046.00X		A60	75W	E27
9046.96X		TC-D	18W	G24 d-2

9045.00X		A60	75W	E27
9045.96X		TC-D	18W	G24 d-2

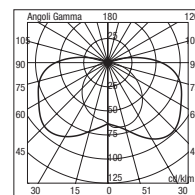
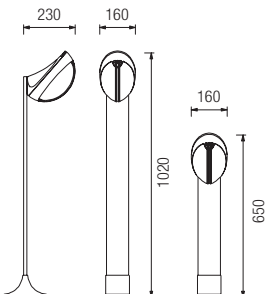

9045 96



9246 doppia / double H 1020

9245 doppia / double H 650

9246.00X		A60	2x75W	E27
9246.96X		TC-D	2x18W	G24 d-2

9245.00X		A60	2x75W	E27
9245.96X		TC-D	2x18W	G24 d-2

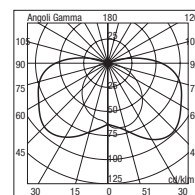
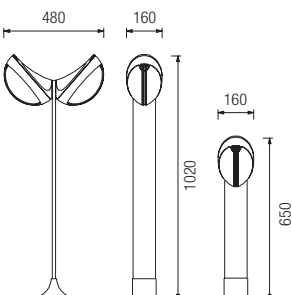

9246 96

AIRONE

AIRONE



9048 H 1020

9047 H 650

9048.00X		A60	75W	E27
9048.96X		TC-D	18W	G24 d-2
9047.00X		A60	75W	E27
9047.96X		TC-D	18W	G24 d-2

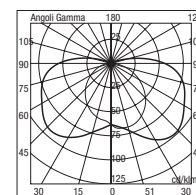

9048 96

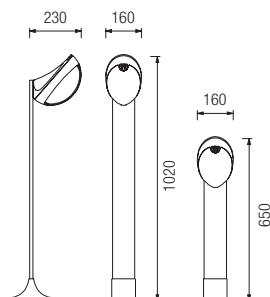

9248 doppia / double H 1020

9247 doppia / double H 650

9248.00X		A60	2x75W	E27
9248.96X		TC-D	2x18W	G24 d-2
9247.00X		A60	2x75W	E27
9247.96X		TC-D	2x18W	G24 d-2

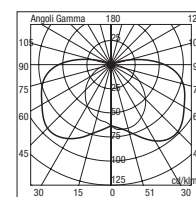

9247 96

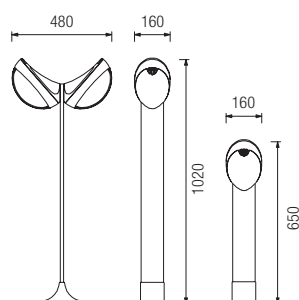





ROSE

ROSE

Apparecchio da parete per interni ed esterni costituito da:

- Corpo in alluminio pressofuso
- Diffusore in policarbonato satinato
- Parabola riflettente in alluminio
- Guarnizione in silicone
- Viti di chiusura in acciaio inox
- Verniciatura in polveri poliestere ad elevata resistenza ai raggi ultravioletti e alla corrosione

Indoor and outdoor wall luminaire constructed of:

- Die-cast aluminium body
- Satin polycarbonate diffuser
- Aluminium reflector
- Silicon gasket
- Stainless steel screws
- Painting using high resistance to UV and corrosion polyester powders



Colori - Colours

X=2  Bianco
White

X=3  Nero
Black

X=9  Antracite
Anthracite

X=4  Silver

Diffusore - Diffuser

Codice-Code 08 1618 - 08 1620

Le lampadine vengono fornite solo su richiesta

Bulbs supplied only on request

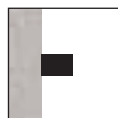

Installazione a parete
Wall mounting

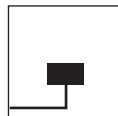

Entrata singola
cavi di alimentazione
Single power supply
cables input

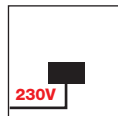

LED - art. 1618.88X - 1620.88X
Led a tensione di rete 230V 50Hz.
Connessione diretta alla rete di
alimentazione senza necessità di
trasformatore.

LED's operation at 230V 50Hz voltage directly.
No transformer is required.

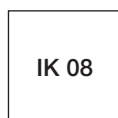

IK 08



1618

1618.00X		A60	60W	E27
1618.92X		TC-D	10W	G24 d-1
1618.88X		1LED bianco/white	4,1W	230 lm 6300 K

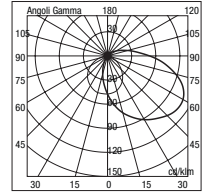
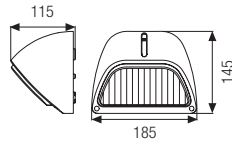

1618 00



1620

1620.00X		A60	75W	E27
1620.96X		TC-D	18W	G24 d-2
1620.88X		2LED bianco/white	8,2W	460 lm 6300 K

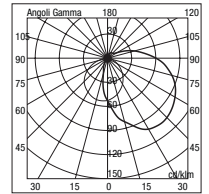
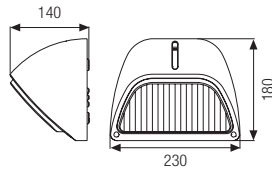

1620 96





STELLA

LEM



STELLA

Apparecchio per interni ed esterni costituito da:

- Corpo in alluminio pressofuso verniciato
- Diffusore in vetro satinato o policarbonato opale
- Parabola riflettente in alluminio
- Guarnizioni in EPDM
- Viti di chiusura in acciaio inox
- Verniciatura in polveri poliesteri ad elevata resistenza ai raggi ultravioletti e alla corrosione

Indoor and outdoor luminaire constructed of:

- Die-cast aluminium body
- Satin glass or opal polycarbonate diffuser
- Aluminium reflector
- EPDM gaskets
- Stainless steel screws
- Painting using high resistance to UV and corrosion polyester powders



Colori - Colours

X=2 Bianco
White

X=3 Nero
Black

X=9 Antracite
Anthracite

X=4 Silver

Diffusore - Diffuser

Codice-Code 00 1000

Vetro/Glass

Codice-Code 08 1000

Polycarbonato/Polycarbonate

Le lampadine vengono fornite solo su richiesta

Bulbs supplied only on request

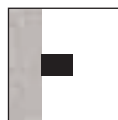

Installazione a parete
Wall mounting

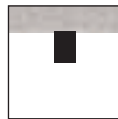

Installazione a soffitto
Ceiling mounting

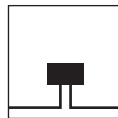

Doppia entrata
cavi di alimentazione
Double power supply
cables input

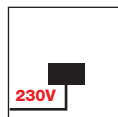

16 LED
L'apparecchio è fornito completo di alimentatore elettronico Full Range 100/240V 50/60Hz posizionato all'interno dell'apparecchio.
The luminaire is supplied with a Full Range 100/240V 50/60Hz built-in transformer

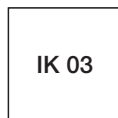

diffusore vetro
glass diffuser



diffusore policarbonato
polycarbonate diffuser

- Gli apparecchi della serie Stella sono forniti con diffusore in vetro. Su richiesta sono disponibili anche con diffusore in policarbonato.

The luminaires of the Stella series are supplied with a glass diffuser. Available also with polycarbonate diffuser on request.



3040

3040.00X		A60	75W	E27
3040.96X		TC-D	18W	G24 d-2
3040.95X		TC-D	26W	G24 d-3
3040.66X		16LED bianco/white	9W	900 lm 4000 K

Con alimentatore elettronico incorporato / Built-in electronic power supplier

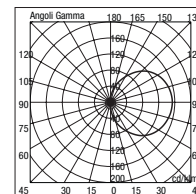

3040 00

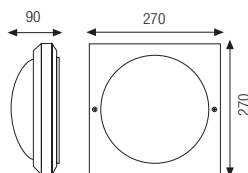

3041

3041.00X		A60	75W	E27
3041.96X		TC-D	18W	G24 d-2
3041.95X		TC-D	26W	G24 d-3
3041.66X		16LED bianco/white	9W	900 lm 4000 K

Con alimentatore elettronico incorporato / Built-in electronic power supplier

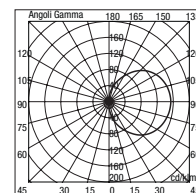

3041 00

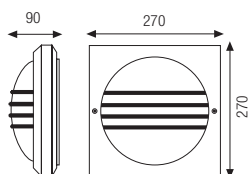

3042

3042.00X		A60	75W	E27
3042.96X		TC-D	18W	G24 d-2
3042.95X		TC-D	26W	G24 d-3
3042.66X		16LED bianco/white	9W	900 lm 4000 K

Con alimentatore elettronico incorporato / Built-in electronic power supplier

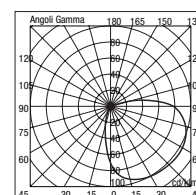

3042 00

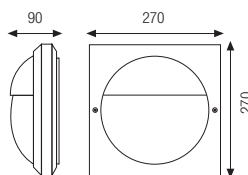

LEM

Apparecchio per interni ed esterni costituito da:

- Corpo in alluminio pressofuso verniciato
- Diffusore in vetro satinato o in policarbonato opale
- Parabola riflettente in alluminio
- Guarnizioni in EPDM
- Viti di chiusura in acciaio inox
- Verniciatura in polveri poliestere ad elevata resistenza ai raggi ultravioletti e alla corrosione

Indoor and outdoor luminaire constructed of:

- Painted die-cast aluminium structure
- Satin glass or opal polycarbonate diffuser
- Aluminium reflector
- EPDM gaskets
- Stainless steel screws
- Painting using high resistance to UV and corrosion polyester powders



Colori - Colours

X=2  Bianco
White

X=3  Nero
Black

X=9  Antracite
Anthracite

X=4  Silver

Diffusore - Diffuser

per/for LEM ROUND MINI

Codice-Code 00 861 - Vetro/Glass

per/for LEM ROUND

Codice-Code 00 1000 - Vetro/Glass

Codice-Code 08 1000

Policarbonato/Polycarbonate

per/for LEM MAXI

Codice-Code 00 859 - Vetro/Glass

per/for LEM OVAL

Codice-Code 00 1006 - Vetro/Glass

Codice-Code 08 1006

Policarbonato/Polycarbonate

Le lampadine vengono fornite solo su richiesta

Bulbs supplied only on request

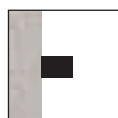

Installazione a parete
Wall mounting



Installazione a soffitto
Ceiling mounting

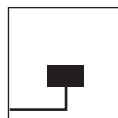

LEM MINI / OVAL
Entrata singola
cavi di alimentazione
Single power supply
cables input

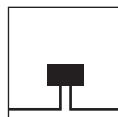

LEM MAXI / ROUND
Doppia entrata
cavi di alimentazione
Double power supply
cables input

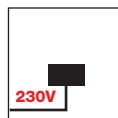

16 LED
L'apparecchio è fornito completo di alimentatore elettronico Full Range 100/240V 50/60Hz posizionato all'interno dell'apparecchio
The luminaire is supplied with a Full Range 100/240V 50/60Hz built-in transformer.

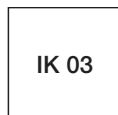

diffusore vetro
glass diffuser



diffusore policarbonato
polycarbonate diffuser

- Gli apparecchi LEM sono forniti con diffusore in vetro. Su richiesta gli articoli LEM ROUND e LEM OVAL sono disponibili anche con diffusore in policarbonato.

Luminaires LEM are supplied with a glass diffuser. The articles LEM ROUND and LEM OVAL are available also with polycarbonate diffuser on request.



1003

Disponibile solo con diffusore in vetro.
Available only with glass diffuser.

1003.00X  A60 60W E27

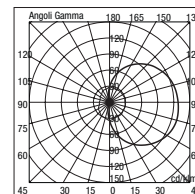
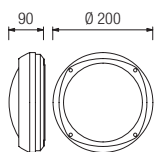

1003 00



1004

Disponibile solo con diffusore in vetro.
Available only with glass diffuser.

1004.00X  A60 60W E27

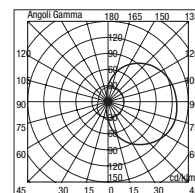
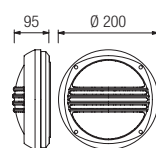

1004 00



1005

Disponibile solo con diffusore in vetro.
Available only with glass diffuser.

1005.00X  A60 60W E27

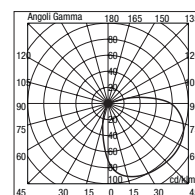
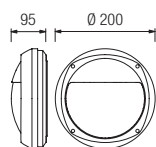

1005 00

LEM ROUND

LEM ROUND



1000

Diffusore in vetro o in policarbonato.
Glass or polycarbonate diffuser.

1000.00X		A60	100W	E27
1000.96X		TC-D	18W	G24 d-2
1000.95X		TC-D	26W	G24 d-3
1000.66X		16LED bianco/white	9W	900 lm 4000 K

Con alimentatore elettronico incorporato / Built-in electronic power supplier

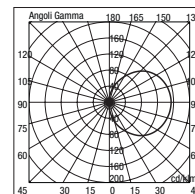
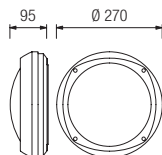

1000 00



1001

Diffusore in vetro o in policarbonato.
Glass or polycarbonate diffuser.

1001.00X		A60	100W	E27
1001.96X		TC-D	18W	G24 d-2
1001.95X		TC-D	26W	G24 d-3
1001.66X		16LED bianco/white	9W	900 lm 4000 K

Con alimentatore elettronico incorporato / Built-in electronic power supplier

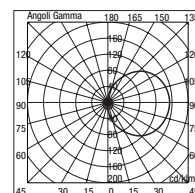
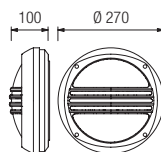

1001 00



1002

Diffusore in vetro o in policarbonato.
Glass or polycarbonate diffuser.

1002.00X		A60	100W	E27
1002.96X		TC-D	18W	G24 d-2
1002.95X		TC-D	26W	G24 d-3
1002.66X		16LED bianco/white	9W	900 lm 4000 K

Con alimentatore elettronico incorporato / Built-in electronic power supplier

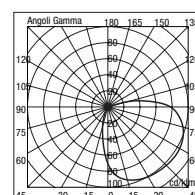
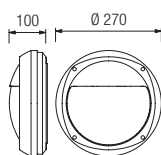

1002 00

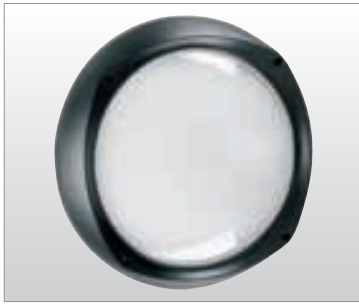

8010

Disponibile solo con diffusore in vetro.
Available only with glass diffuser.

8010.00X		A60	2x60W	E27
8010.95X		TC-D	2x26W	G24 d-3
8010.98X		TC-L	2x18W	2G11

Con reattore elettronico - With electronic ballast

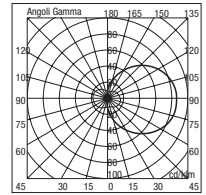
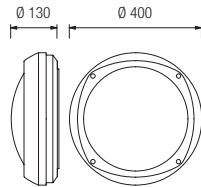

8010 00



8011

Disponibile solo con diffusore in vetro.
Available only with glass diffuser.

8011.00X		A60	2x60W	E27
8011.95X		TC-D	2x26W	G24 d-3
8011.98X		TC-L	2x18W	2G11

Con reattore elettronico - With electronic ballast

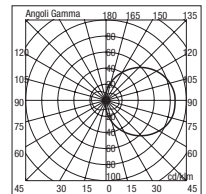
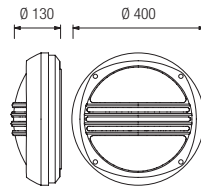

8011 95



8012

Disponibile solo con diffusore in vetro.
Available only with glass diffuser.

8012.00X		A60	2x60W	E27
8012.95X		TC-D	2x26W	G24 d-3
8012.98X		TC-L	2x18W	2G11

Con reattore elettronico - With electronic ballast

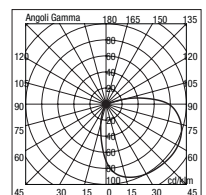
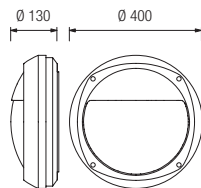

8012 95

LEM OVAL

LEM OVAL



1006

Diffusore in vetro o in policarbonato.
Glass or polycarbonate diffuser.

1006.00X		A60	100W	E27
1006.96X		TC-D	18W	G24 d-2
1006.95X		TC-D	26W	G24 d-3

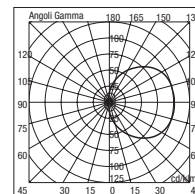
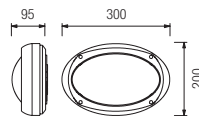

1006 00



1007

Diffusore in vetro o in policarbonato.
Glass or polycarbonate diffuser.

1007.00X		A60	100W	E27
1007.96X		TC-D	18W	G24 d-2
1007.95X		TC-D	26W	G24 d-3

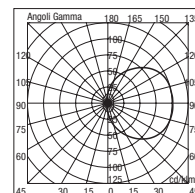
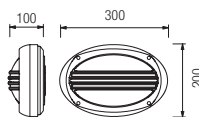

1007 00



1008

Diffusore in vetro o in policarbonato.
Glass or polycarbonate diffuser.

1008.00X		A60	100W	E27
1008.96X		TC-D	18W	G24 d-2
1008.95X		TC-D	26W	G24 d-3

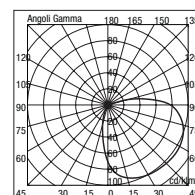
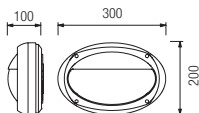

1008 00







LASER



LASER

Apparecchio per interni ed esterni costituito da:

- Corpo in alluminio pressofuso verniciato
- Diffusore in vetro con lavorazione nido d'ape o in policarbonato
- Parabola riflettente in alluminio
- Guarnizione in EPDM
- Viti di chiusura in acciaio inox
- Verniciatura in polveri poliestere ad elevata resistenza ai raggi ultravioletti e alla corrosione

Indoor and outdoor luminaire constructed of:

- Painted die-cast aluminium body
- Patterned glass or polycarbonate diffuser
- Aluminium reflector
- EPDM gasket
- Stainless steel screws
- Painting using high resistance to UV and corrosion polyester powders



Colori - Colours

X=2 Bianco
White

X=3 Nero
Black

X=9 Antracite
Anthracite

X=4 Silver

Diffusore - Diffuser

Codice-Code 00 3080

Vetro a nido d'ape

/Patterned glass

Codice-Code 08 1000

Policarbonato opale

/Opal polycarbonate

Le lampadine vengono fornite solo su richiesta

Bulbs supplied only on request

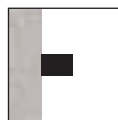

Installazione a parete
Wall mounting

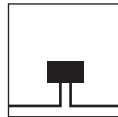

Doppia entrata
cavi di alimentazione
Double power supply
cables input

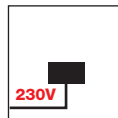

16 LED
L'apparecchio è fornito completo di alimentatore elettronico Full Range 100/240V posizionato all'interno dell'apparecchio
The luminaire is supplied with a Full Range 100/240V built-in transformer

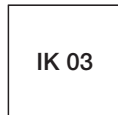

diffusore vetro
glass diffuser



diffusore policarbonato
polycarbonate diffuser

- **Gli apparecchi della serie Laser sono forniti con diffusore in vetro. Su richiesta sono disponibili anche con diffusore in policarbonato.**

The luminaires of the Laser series are supplied with a glass diffuser.
Available also with polycarbonate diffuser on request.



3082

3082.00X		A60	75W	E27
3082.96X		TC-D	18W	G24 d-2
3082.95X		TC-D	26W	G24 d-3
3082.66X		16LED bianco/white	9W	900 lm 4000 K

Con alimentatore elettronico incorporato / Built-in electronic power supplier

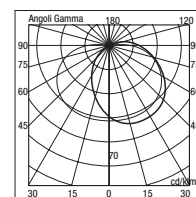
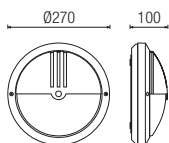

3082 95



3083

3083.00X		A60	75W	E27
3083.96X		TC-D	18W	G24 d-2
3083.95X		TC-D	26W	G24 d-3
3083.66X		16LED bianco/white	9W	900 lm 4000 K

Con alimentatore elettronico incorporato / Built-in electronic power supplier

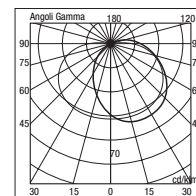
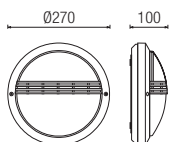

3083 95

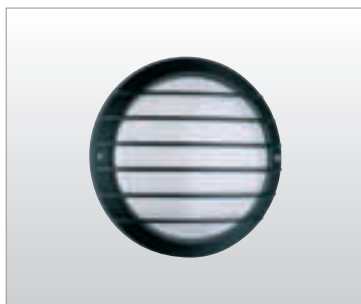

3084

3084.00X		A60	75W	E27
3084.96X		TC-D	18W	G24 d-2
3084.95X		TC-D	26W	G24 d-3
3084.66X		16LED bianco/white	9W	900 lm 4000 K

Con alimentatore elettronico incorporato / Built-in electronic power supplier

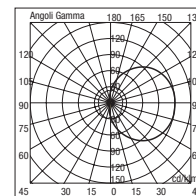
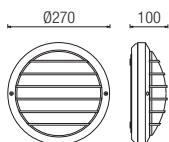

3084 00



3085

3085.00X		A60	75W	E27
3085.96X		TC-D	18W	G24 d-2
3085.95X		TC-D	26W	G24 d-3
3085.66X		16LED bianco/white	9W	900 lm 4000 K

Con alimentatore elettronico incorporato / Built-in electronic power supplier

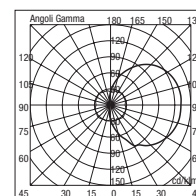
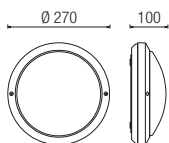

3085 00





ASTRA

REM



ASTRA

Apparecchio per interni ed esterni costituito da:

- Corpo in alluminio pressofuso verniciato
- Diffusore in vetro satinato oppure policarbonato opale
- Parabola riflettente in alluminio
- Guarnizione in EPDM
- Viti di chiusura in acciaio inox
- A richiesta controcassa in tecnopolimero per semincasso
- Verniciatura in polveri poliestere ad elevata resistenza ai raggi ultravioletti e alla corrosione

Indoor and outdoor luminaire constructed of:

- Painted die-cast aluminium body
- Satin or opal polycarbonate diffuser
- Aluminium reflector
- EPDM gasket
- Stainless steel screws
- Technopolymer box for semi-recessing on request
- Painting using high resistance to UV and corrosion polyester powders



Colori - Colours

X=2 Bianco White

X=3 Nero Black

X=4 Silver

Diffusore - Diffuser

Codice-Code 00 9380

Vetro/Glass

Codice-Code 08 9380

Polic. OP/Polyc. OP

Le lampadine vengono fornite solo su richiesta

Bulbs supplied only on request

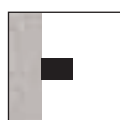

Installazione a parete
Wall mounting

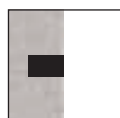

Incasso a muro
Recessed wall version

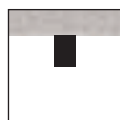

Cod. 9320 - 9321
Installazione a soffitto
Ceiling mounting

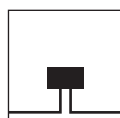

Doppia entrata
cavi di alimentazione
Double power supply
cables input

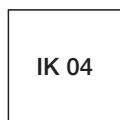

diffusore vetro
glass diffuser



diffusore policarbonato
polycarbonate diffuser



ACCESSORIO
CS 93

Controcassa in tecnopolimero da incassare a filo muro prima dell'installazione della lampada.

Technopolymer holder to be recessed flush with the wall before the installation of the luminaire.

Ø mm 260 - h mm 60.

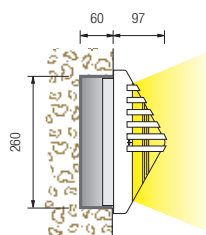

- Gli apparecchi della serie Astra sono forniti con diffusore in vetro. Su richiesta sono disponibili anche con diffusore in policarbonato.

The luminaires of the Astra series are supplied with a glass diffuser. Available also with polycarbonate diffuser on request.



9320

9320.00X		A60	75W	E27
9320.96X		TC-D	18W	G24 d-2
9320.95X		TC-D	26W	G24 d-3

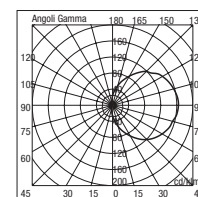
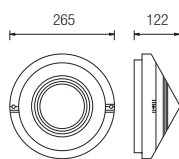

9320 00

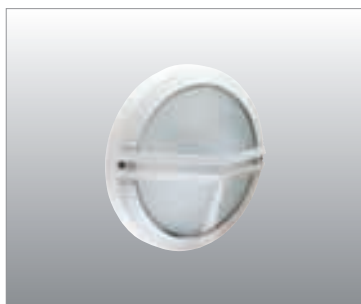

9321

9321.00X		A60	75W	E27
9321.96X		TC-D	18W	G24 d-2
9321.95X		TC-D	26W	G24 d-3

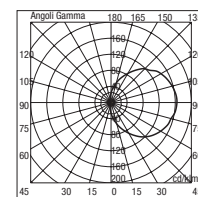
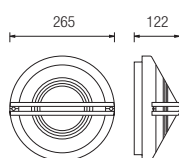

9321 00

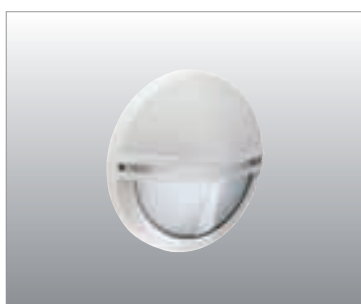

9322

9322.00X		A60	75W	E27
9322.96X		TC-D	18W	G24 d-2
9322.95X		TC-D	26W	G24 d-3

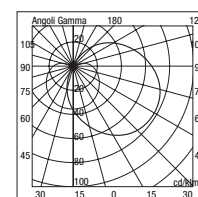
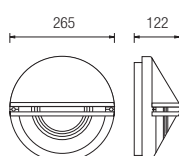

9322 00

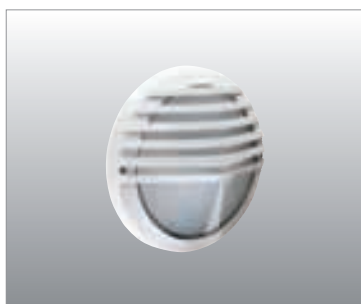

9324

9324.00X		A60	75W	E27
9324.96X		TC-D	18W	G24 d-2
9324.95X		TC-D	26W	G24 d-3

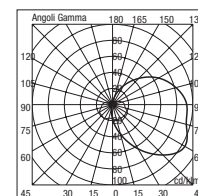
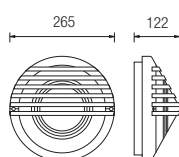

9324 00

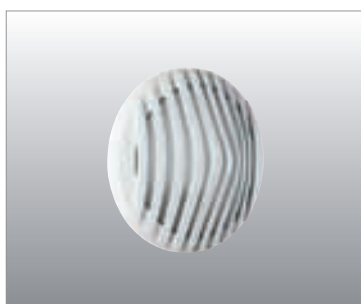

9325

9325.00X		A60	75W	E27
9325.96X		TC-D	18W	G24 d-2
9325.95X		TC-D	26W	G24 d-3

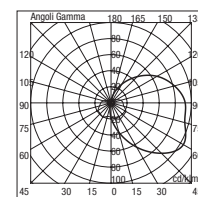
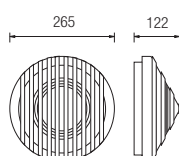

9325 00

REM

Apparecchio per interni ed esterni
costituito da:

- Corpo in alluminio pressofuso verniciato
- Diffusore in vetro satinato
- Parabola riflettente in alluminio
- Guarnizioni in EPDM
- Viti di chiusura in acciaio inox
- Verniciatura in polveri poliestere ad elevata resistenza ai raggi ultravioletti e alla corrosione

Indoor and outdoor luminaire
constructed of:

- Painted die-cast aluminium structure
- Satin glass diffuser
- Aluminium reflector
- EPDM gaskets
- Stainless steel screws
- Painting using high resistance to UV and corrosion polyester powders



Colori - Colours

X=2 Bianco
White

X=3 Nero
Black

X=9 Antracite
Anthracite

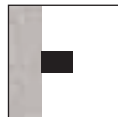

Installazione a parete
Wall mounting

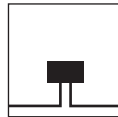

Doppia entrata
cavi di alimentazione
Double power supply
cables input

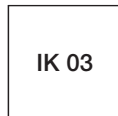

Diffusore - Diffuser

Codice-Code 00 1060

Codice-Code 00 1000

per/for Cod. 1009

**Le lampadine vengono fornite
solo su richiesta**

Bulbs supplied only
on request



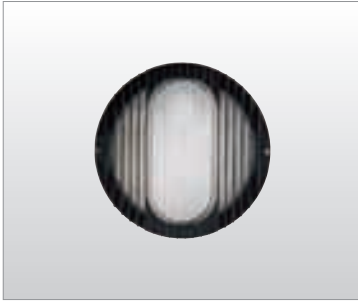

1060

1060.00X		A60	75W	E27
1060.96X		TC-D	18W	G24 d-2
1060.95X		TC-D	26W	G24 d-3

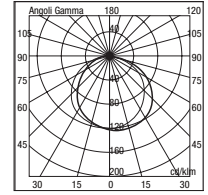
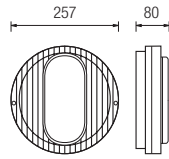

1060 00



1061

1061.00X		A60	75W	E27
1061.96X		TC-D	18W	G24 d-2
1061.95X		TC-D	26W	G24 d-3

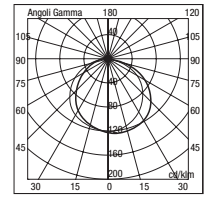
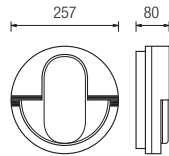

1061 00



1062

1062.00X		A60	75W	E27
1062.96X		TC-D	18W	G24 d-2
1062.95X		TC-D	26W	G24 d-3

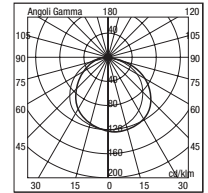
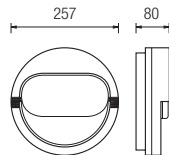

1062 00



1009

1009.00X		A60	75W	E27
1009.96X		TC-D	18W	G24 d-2
1009.95X		TC-D	26W	G24 d-3

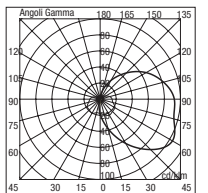
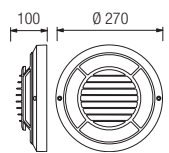

1009 00





IBIS

IBIS STELO



IBIS

Apparecchio da parete per interni ed esterni costituito da:

- Corpo in alluminio pressofuso
- Diffusore in vetro satinato o in policarbonato
- Parabola riflettente in alluminio
- Guarnizione in EPDM
- Viti di chiusura in acciaio inox
- Verniciatura in polveri poliestere ad elevata resistenza ai raggi ultravioletti e alla corrosione

Indoor and outdoor wall luminaire constructed of:

- Die-cast aluminium body
- Satin or polycarbonate glass diffuser
- Aluminium reflector
- EPDM gasket
- Stainless steel screws
- Painting using high resistance to UV and corrosion polyester powders

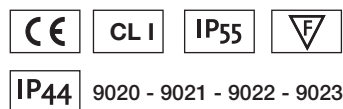

Colori - Colours

- X=2 Bianco
White
- X=3 Nero
Black

Diffusore - Diffuser

Codice-Code 00 4000

Vetro ovale /Oval glass

Codice-Code 08 4020

Polic. ovale /Oval polyc.

Codice-Code 00 860

Vetro tondo /Round glass

Codice-Code 08 3020

Polic. tondo /Round polyc.

Codice-Code 00 861

Vetro/ Glass

per/for Cod. 9010

Le lampadine vengono fornite solo su richiesta

Bulbs supplied only on request

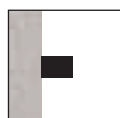

Installazione a parete
Wall mounting



Per/for Cod. 9020 - 9021 - 9022 - 9023
Installazione a terra
Floor mounting

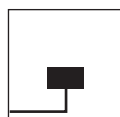

Entrata singola
cavi di alimentazione
Single power supply
cables input

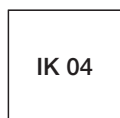

diffusore vetro
glass diffuser



diffusore policarbonato
polycarbonate diffuser

- Gli apparecchi della serie Ibis sono forniti con diffusore in vetro. Su richiesta sono disponibili anche con diffusore in policarbonato.

The luminaires of the Ibis series are supplied with a glass diffuser. Available also with polycarbonate diffuser on request.

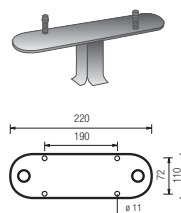

CP 90
ACCESSORIO PER PALO
Controbasso di fissaggio a terra
ACCESSORY FOR POST
Root-mount for ground fixing



9000

9000.00X		A60	75W	E27
9000.96X		TC-D	18W	G24 d-2

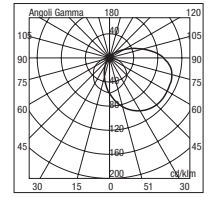
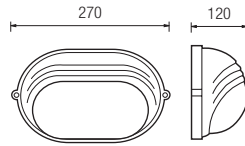

9000 00



9001

9001.00X		A60	75W	E27
9001.96X		TC-D	18W	G24 d-2

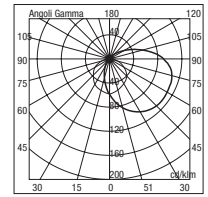
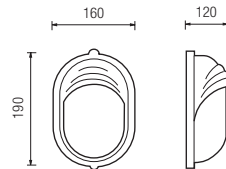

9001 00



9010 Ø 190

9010.00X		A60	60W	E27
-----------------	--	-----	-----	-----

Solo con diffusore in vetro
Only with glass diffuser

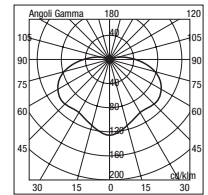
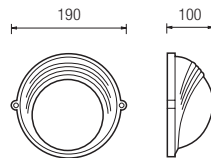

9010 00



9008 Ø 240

9008.00X		A60	100W	E27
9008.96X		TC-D	18W	G24 d-2

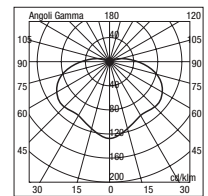
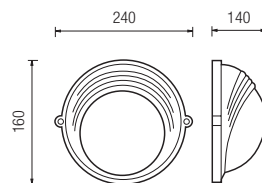

9008 00

IBIS STELO

IBIS STELO



9021 1 luce/1 light H 960
9022 2 luce/2 lights H 960

Piantana da giardino composta da:

- Corpo in alluminio pressofuso
- Palo in alluminio estruso

Garden post luminaire constructed of:

- Die-cast aluminium body
- Extruded aluminium post

9021.00X		A60	75W	E27
9021.96X		TC-D	18W	G24 d-2

9022.00X		A60	2x75W	E27
9022.96X		TC-D	2x18W	G24 d-2

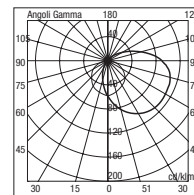

9021 00

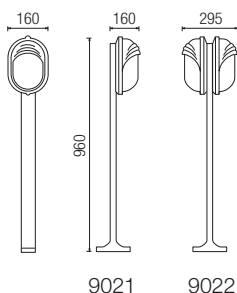

9020 1 luce/1 light H 550
9023 2 luce/2 lights H 550

9020.00X		A60	75W	E27
9020.96X		TC-D	18W	G24 d-2

9023.00X		A60	2x75W	E27
9023.96X		TC-D	2x18W	G24 d-2

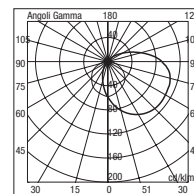

9020 00

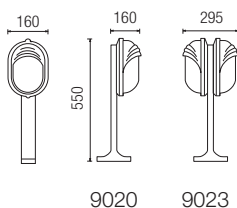







KAPPA



KAPPA

Apparecchio da parete o da soffitto per interni ed esterni costituito da:

- Corpo in alluminio pressofuso verniciato
- Diffusore in vetro satinato
- Guarnizione in EPDM
- Viti di chiusura in acciaio inox
- Verniciatura in polveri poliestere ad elevata resistenza ai raggi ultravioletti e alla corrosione

Indoor and outdoor wall or ceiling luminaire constructed of:

- Painted die-cast aluminium body
- Satin glass diffuser
- EPDM gasket
- Stainless steel screws
- Painting using high resistance to UV and corrosion polyester powders

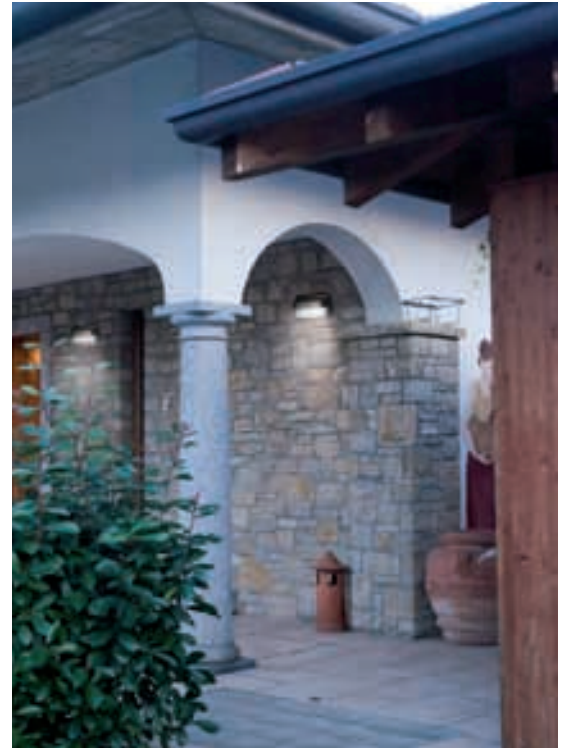

Colori - Colours

X=2  Bianco
White

X=3  Nero
Black

X=4  Silver

Diffusore - Diffuser

Codice-Code 00 9030

Le lampadine vengono fornite solo su richiesta

Bulbs supplied only on request

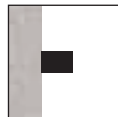

Installazione a parete
Wall mounting

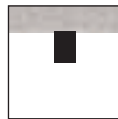

Installazione a soffitto
Ceiling mounting

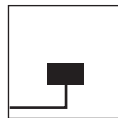

Entrata singola
cavi di alimentazione
Single power supply
cables input

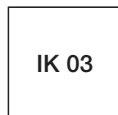

IK 03

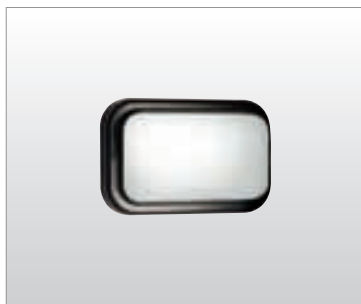

9030

9030.00X		A60	60W	E27
9030.80X		TC	2x9W	G23

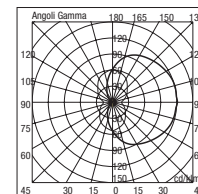
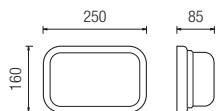

9030 00

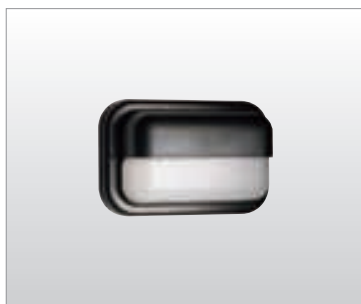

9031

9031.00X		A60	60W	E27
9031.80X		TC	2x9W	G23

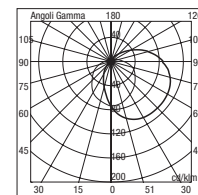
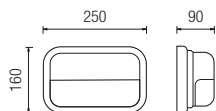

9031 00



9032

9032.00X		A60	60W	E27
9032.80X		TC	2x9W	G23

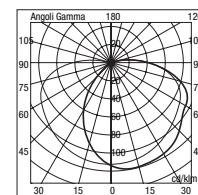
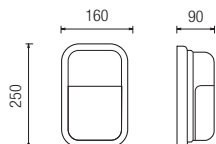

9032 00



9033

9033.00X		A60	60W	E27
9033.80X		TC	2x9W	G23

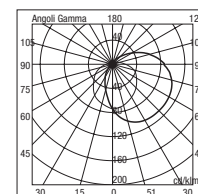
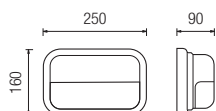

9033 00

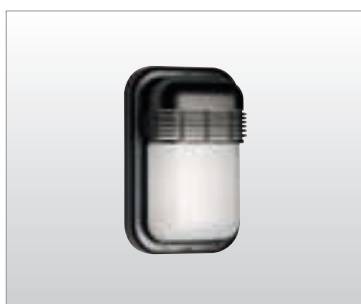

9034

9034.00X		A60	60W	E27
9034.80X		TC	2x9W	G23

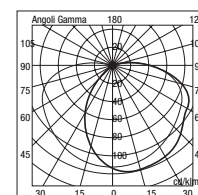
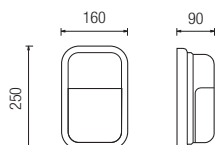

9034 00





ALFA

IRON



ALFA

Apparecchio per interni ed esterni costituito da:

- Corpo in alluminio pressofuso verniciato
- Diffusore in vetro satinato o in policarbonato opale
- Parabola riflettente in alluminio
- Guarnizione in EPDM
- Viti di chiusura in acciaio inox
- Verniciatura in polveri poliestere ad elevata resistenza ai raggi ultravioletti e alla corrosione

Indoor and outdoor luminaire constructed of:

- Painted die-cast aluminium body
- Opal polycarbonate or satin glass diffuser
- Aluminium reflector
- EPDM gasket
- Stainless steel screws
- Painting using high resistance to UV and corrosion polyester powders



IP54 3012 - 9011 - 9014

ALFA ROUND / OVAL

Colori - Colours

X=2 Bianco
White

X=3 Nero
Black

X=9 Antracite
Anthracite

X=4 Silver

ALFA

Colori - Colours

X=2 Bianco
White

X=3 Nero
Black

Le lampadine vengono fornite solo su richiesta

Bulbs supplied only on request

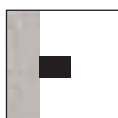

Installazione a parete
Wall mounting



Installazione a soffitto
Ceiling mounting

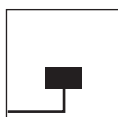

Entrata singola
cavi di alimentazione
Single power supply
cables input

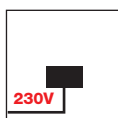

24 LED
L'apparecchio è fornito completo di alimentatore elettronico Full Range 100/240V 50/60Hz posizionato all'interno dell'apparecchio.
The luminaire is supplied with a Full Range 100/240V 50/60Hz built-in transformer

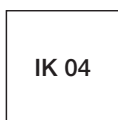

diffusore vetro
glass diffuser

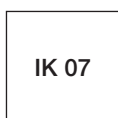

diffusore policarbonato
polycarbonate diffuser

- **Gli apparecchi della serie Alfa sono forniti con diffusore in vetro. Su richiesta sono disponibili anche con diffusore in policarbonato.**

The luminaires of the Alfa series are supplied with a glass diffuser.

Available also with polycarbonate diffuser on request.

Direttiva/Directive

EuP/ErP (2005/52/CE-2009/125/CE)

Gli apparecchi per lampade a scarica ad alta intensità sono progettati per lampade chiare e opali.

Luminaires for high intensity discharge lamps are designed for either clear and coated lamps.

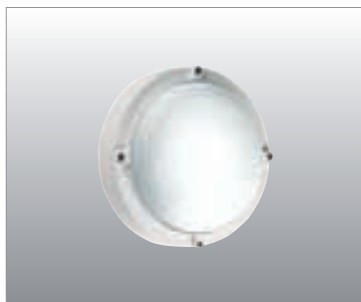

3019

3019.96X		TC-D	18W	G24 d-2
• 3019.82X		24LED bianco/white	12W	800 lm 3200 K
• 3019.87X		24LED bianco/white	12W	850 lm 5000 K

Solo con diffusore in policarbonato / Only with polycarbonate diffuser

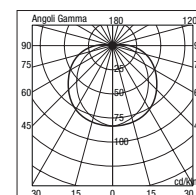
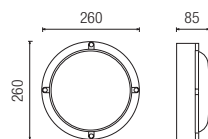

3019 96

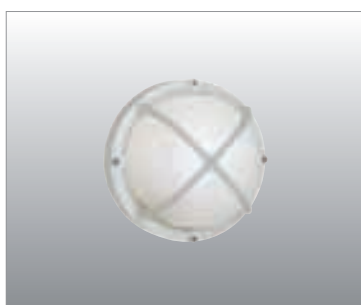

3020

3020.00X		A60	100W	E27
3020.96X		TC-D	18W	G24 d-2
3020.95X		TC-D	26W	G24 d-3
3020.51X		HME	50W	E27
• 3020.82X		24LED bianco/white	12W	800 lm 3200 K
• 3020.87X		24LED bianco/white	12W	850 lm 5000 K

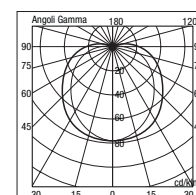
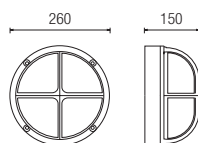

3020 00

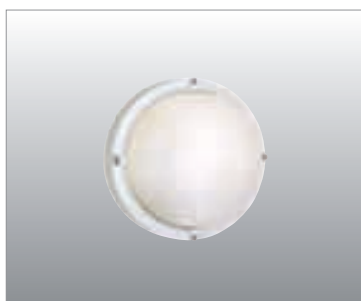

3021

3021.00X		A60	100W	E27
3021.96X		TC-D	18W	G24 d-2
3021.95X		TC-D	26W	G24 d-3
3021.51X		HME	50W	E27
• 3021.82X		24LED bianco/white	12W	800 lm 3200 K
• 3021.87X		24LED bianco/white	12W	850 lm 5000 K

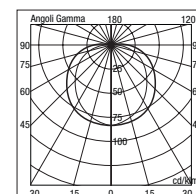
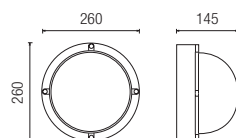

3021 00

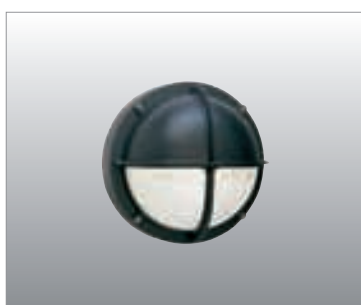

3022

3022.00X		A60	100W	E27
3022.96X		TC-D	18W	G24 d-2
3022.95X		TC-D	26W	G24 d-3
3022.51X		HME	50W	E27
• 3022.82X		24LED bianco/white	12W	800 lm 3200 K
• 3022.87X		24LED bianco/white	12W	850 lm 5000 K

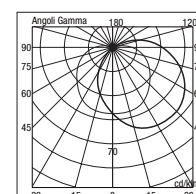
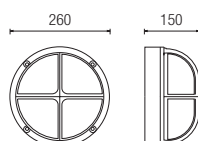

3022 00

Diffusore - Diffuser

Codice-Code 08 3019 Polic. OP/Polyc.OP

Codice-Code 00 860 Vetro/Glass

Codice-Code 08 3020 Polic. OP/Polyc.OP

• Con alimentatore elettronico incorporato
Built-in electronic power supplier

ALFA OVAL

ALFA OVAL



4020

4020.00X		A60	75W	E27
4020.96X		TC-D	18W	G24 d-2
4020.95X		TC-D	26W	G24 d-3
4020.51X		HME	50W	E27

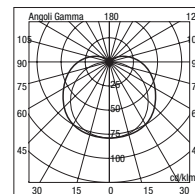
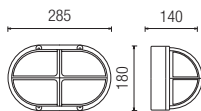

4020 00



4021

4021.00X		A60	75W	E27
4021.96X		TC-D	18W	G24 d-2
4021.95X		TC-D	26W	G24 d-3
4021.51X		HME	50W	E27

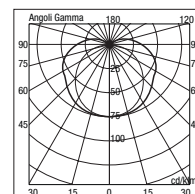
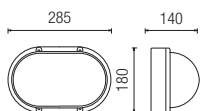

4021 00

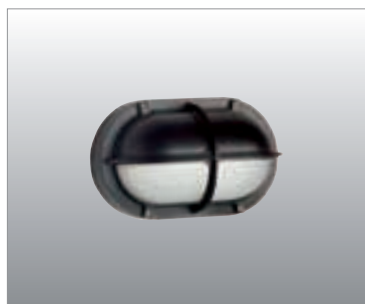

4022

4022.00X		A60	75W	E27
4022.96X		TC-D	18W	G24 d-2
4022.95X		TC-D	26W	G24 d-3
4022.51X		HME	50W	E27

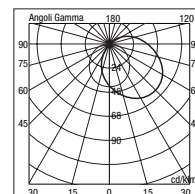
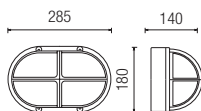

4022 00



4023

4023.00X		A60	75W	E27
4023.96X		TC-D	18W	G24 d-2
4023.95X		TC-D	26W	G24 d-3
4023.51X		HME	50W	E27

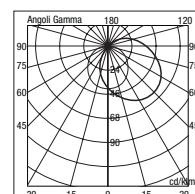
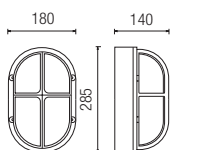

4023 00

Diffusore - Diffuser

Codice-Code 00 4000 Vetro/Glass

Codice-Code 08 4020 Polic. OP/Polyc.OP



4000

4000.00X		A60	75W	E27
4000.96X		TC-D	18W	G24 d-2

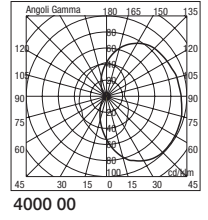
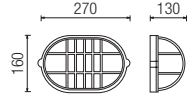

4000 00



4001

4001.00X		A60	75W	E27
4001.96X		TC-D	18W	G24 d-2

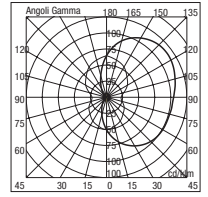
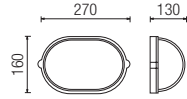

4001 00

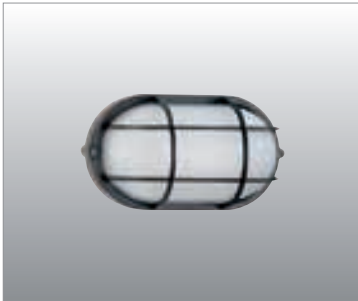

4913

4913.00X		A60	75W	E27
4913.96X		TC-D	18W	G24 d-2

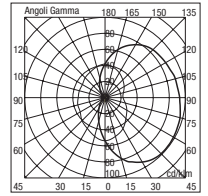
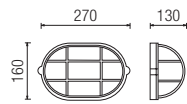

4913 00

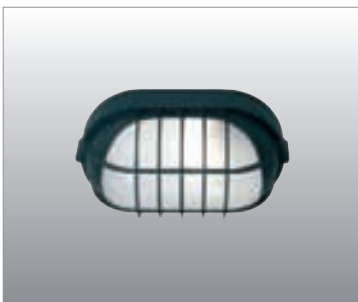

6000

6000.00X		A60	75W	E27
6000.96X		TC-D	18W	G24 d-2

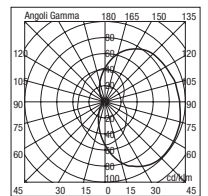
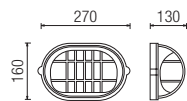

6000 00

Diffusore - Diffuser

Codice-Code	00 4000	per/for	Cod. 4000 - 4001 - 6000
Codice-Code	08 4020	per/for	Cod. 4000 - 4001 - 6000
Codice-Code	00 913	per/for	Cod. 4913

Vetro	/ Glass
Polic.	OP / Polyc. OP
Vetro	/ Glass



3000

3000.00X		A60	100W	E27
3000.96X		TC-D	18W	G24 d-2

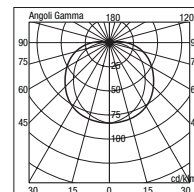
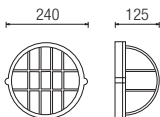

3000 00



3001 Ø 240

3001.00X		A60	100W	E27
3001.96X		TC-D	18W	G24 d-2

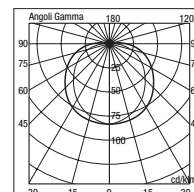
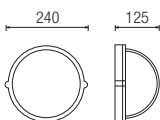

3001 00



3012 Ø 190

3012.00X		A60	60W	E27
-----------------	--	-----	-----	-----

Solo con diffusore in vetro
Only with glass diffuser

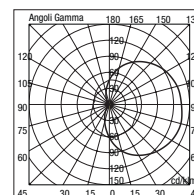
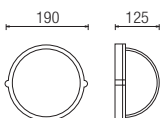

3012 00



3905

3905.00X		A60	100W	E27
3905.96X		TC-D	18W	G24 d-2

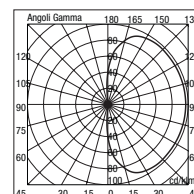
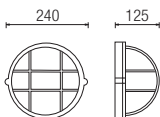

3905 96

Diffusore - Diffuser

Codice-Code 00 860	per/for	Cod. 3000 - 3001	Vetro/Glass
Codice-Code 08 3020	per/for	Cod. 3000 - 3001	Polic. OP/Polyc.OP
Codice-Code 00 905	per/for	Cod. 3905	Vetro/Glass
Codice-Code 00 861	per/for	Cod. 3012	Vetro/Glass

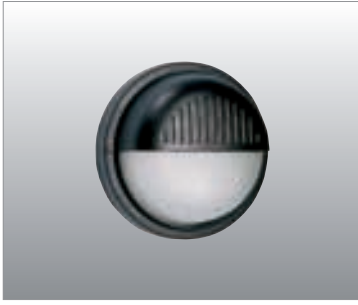

9011 Ø 190

9011.00X  A60 60W E27

Solo con diffusore in vetro Cod. 00 861
Only with glass diffuser

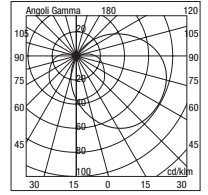
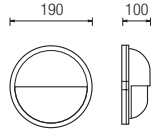

9011 00

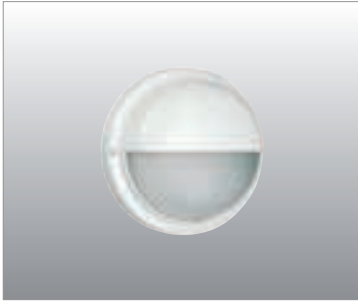

9014 Ø 190

9014.00X  A60 60W E27

Solo con diffusore in vetro Cod. 00 861
Only with glass diffuser

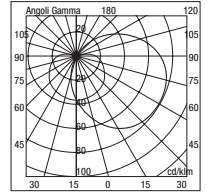
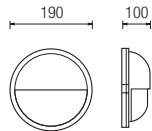

9014 00

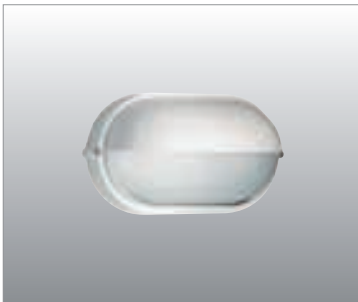

9035

9035.00X  A60 75W E27

9035.96X  TC-D 18W G24 d-2

Diffusore in vetro Cod. 00 4000 Glass diffuser
Diffusore in polic. Cod. 08 4020 Polyc. diffuser

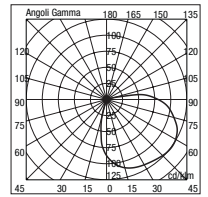
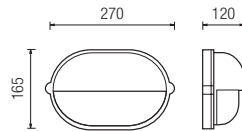

9035 00

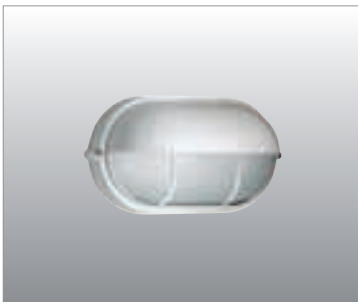

9037

9037.00X  A60 75W E27

9037.96X  TC-D 18W G24 d-2

Diffusore in vetro Cod. 00 913 Glass diffuser
Diffusore in polic. Cod. 08 4020 Polyc. diffuser

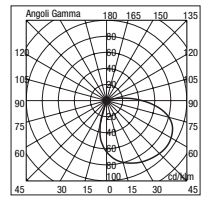
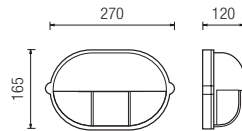

9037 96

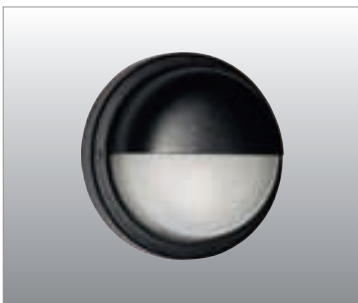

9036 Ø 225

9036.00X  A60 75W E27

9036.96X  TC-D 18W G24 d-2

Diffusore in vetro Cod. 00 860 Glass diffuser
Diffusore in polic. Cod. 08 3020 Polyc. diffuser

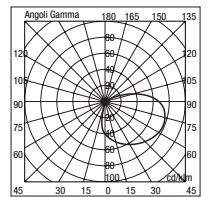
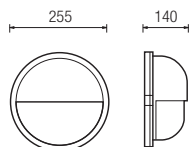

9036 96

IRON

Apparecchio per interni ed esterni
costituito da:

- Corpo in alluminio pressofuso verniciato
- Griglia o anello in metallo verniciato
- Diffusore in vetro satinato
- Parabola riflettente in alluminio
- Guarnizione in EPDM
- Viti di chiusura in acciaio inox
- Verniciatura in polveri poliestere ad elevata resistenza ai raggi ultravioletti e alla corrosione

Indoor and outdoor luminaire
constructed of:

- Painted die-cast aluminium body
- Painted metal grid or bezel
- Satin glass diffuser
- Aluminium reflector
- EPDM gasket
- Stainless steel screws
- Painting using high resistance to UV and corrosion polyester powders



Colori - Colours

X=2  Bianco
White

X=3  Nero
Black

Diffusore - Diffuser

Codice-Code 00 905

per/for Cod. 904/905

Codice-Code 00 901

per/for Cod. 900/901

Codice-Code 00 903

per/for Cod. 902/903

Codice-Code 00 913

per/for Cod. 912/913

Le lampadine vengono fornite
solo su richiesta

Bulbs supplied only
on request

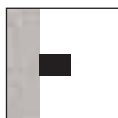

Installazione a parete
Wall mounting



Installazione a soffitto
Ceiling mounting

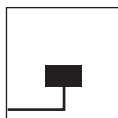

Entrata singola
cavi di alimentazione
Single power supply
cables input

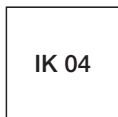

IK 04



0904 Ø 240
0900 Ø 190

0904.00X		A60	100W	E27
0904.96X		TC-D	18W	G24 d-2
0900.00X		A60	60W	E27

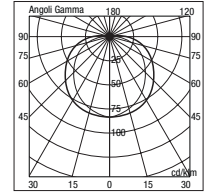
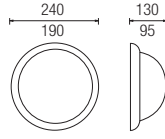

0904 00

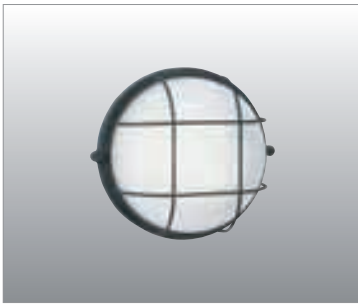

0905 Ø 240
0901 Ø 190

0905.00X		A60	100W	E27
0905.96X		TC-D	18W	G24 d-2
0901.00X		A60	60W	E27

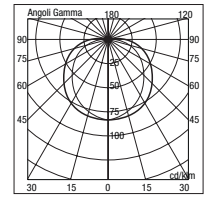
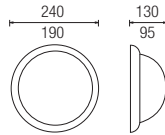

0905 00



0912 27x16
0902 21x21

0912.00X		A60	100W	E27
0912.96X		TC-D	18W	G24 d-2
0902.00X		A60	60W	E27

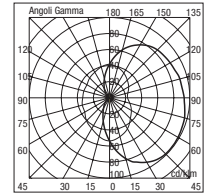
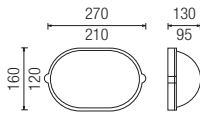

0912 00



0913 27x16
0903 21x21

0913.00X		A60	100W	E27
0913.96X		TC-D	18W	G24 d-2
0903.00X		A60	60W	E27

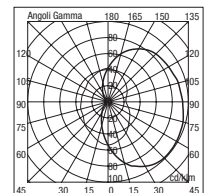
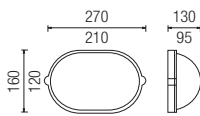

0913 00





LUCY



K 90



BIP

LUCY

Apparecchio per interni ed esterni
costituito da:

- Corpo in materiale termoplastico
- Diffusore in policarbonato satinato
- Parabola riflettente in alluminio
- Viti di chiusura in acciaio inox
- Verniciatura in polveri poliestere ad elevata resistenza ai raggi ultravioletti e alla corrosione

Indoor and outdoor luminaire
constructed of:

- Thermoplastic body
- Satin polycarbonate diffuser
- Aluminium reflector
- Stainless steel screws
- Painting using high resistance to UV and corrosion polyester powders



Colori - Colours

X=2 Bianco
White

X=3 Nero
Black

X=4 Silver

Diffusore - Diffuser

Codice-Code 08 9090

**Le lampadine vengono fornite
solo su richiesta**

Bulbs supplied only
on request

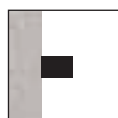

Installazione a parete
Wall mounting



Installazione a soffitto
Ceiling mounting

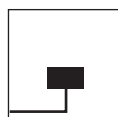

Entrata singola
cavi di alimentazione
Single power supply
cables input

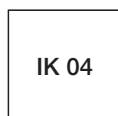

IK 04



9090

9090.00X		A60	60W	E27
9090.96X		TC-D	18W	G24 d-2

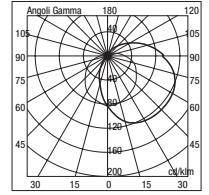
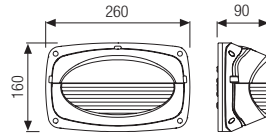

9090 00



9091

9091.00X		A60	60W	E27
9091.96X		TC-D	18W	G24 d-2

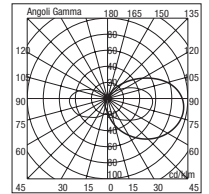
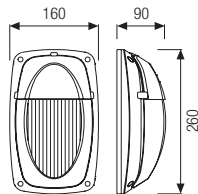

9091 00



9092

9092.00X		A60	60W	E27
9092.96X		TC-D	18W	G24 d-2

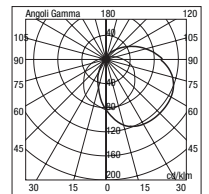
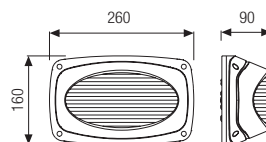

9092 00

K 90

Apparecchio per interni ed esterni costituito da:

- Corpo in materiale termoplastico
- Diffusore in vetro satinato
- Parabola riflettente in alluminio solo per versione incandescenza
- Viti di chiusura in acciaio inox

Indoor and outdoor luminaire constructed of:

- Thermoplastic body
- Satin glass diffuser
- Aluminium reflector for incandescent version only
- Stainless steel screws



Colori - Colours

X=2 Bianco
White

X=3 Nero
Black

X=4 Silver

Diffusore - Diffuser

Codice-Code 00 9030

Le lampadine vengono fornite solo su richiesta

Bulbs supplied only on request

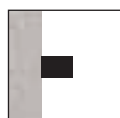

Installazione a parete
Wall mounting



Installazione a soffitto
Ceiling mounting

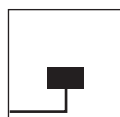

Entrata singola
cavi di alimentazione
Single power supply
cables input

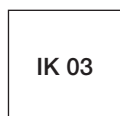

IK 03



9050

9050.00X		A60	60W	E27
9050.91X		TC	9W	G23
9050.80X		TC	2x9W	G23

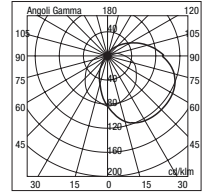
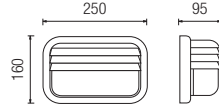

9050 00



9051

9051.00X		A60	60W	E27
9051.91X		TC	9W	G23
9051.80X		TC	2x9W	G23

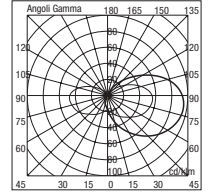
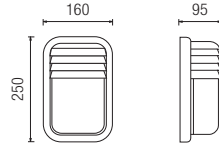

9051 00



9052

9052.00X		A60	60W	E27
9052.91X		TC	9W	G23
9052.80X		TC	2x9W	G23

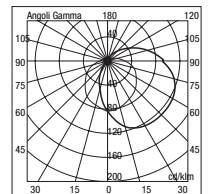
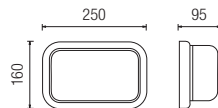

9052 00

BIP

Apparecchio a parete per interni ed esterni costituito da:

- Base in alluminio pressofuso verniciato bianco
- Visiera in policarbonato
- Diffusore in vetro satinato
- Viti di chiusura in acciaio inox

Indoor and outdoor wall luminaire constructed of:

- White-painted die-cast aluminium base
- Polycarbonate cover
- Satin glass diffuser
- Stainless steel screws



Colori - Colours

X=2  Bianco
White

X=3  Nero
Black

X=4  Silver

Diffusore - Diffuser

Codice-Code 00 9080

Le lampadine vengono fornite solo su richiesta

Bulbs supplied only on request

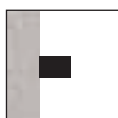

Installazione a parete
Wall mounting

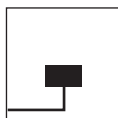

Entrata singola
cavi di alimentazione
Single power supply
cables input

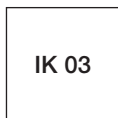

IK 03



9080

9080.00X  A60 60W E27

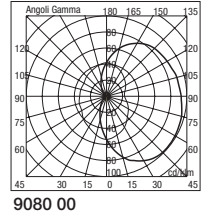
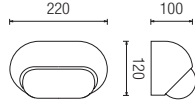

9080 00





MARINA



MARINA

Apparecchio per interni ed esterni
costituito da:

- Corpo in ottone pressofuso
- Griglia in ottone pressofuso
- Diffusore in vetro satinato
- Viti di chiusura in ottone

Indoor and outdoor luminaire
constructed of:

- Die-cast brass body
- Die-cast brass grid
- Satin glass diffuser
- Brass screws



IP43 art. 1190

Diffusore - Diffuser

Codice-Code **00 M85**

Codice-Code **00 M86**

Codice-Code **00 M87**

Codice-Code **00 M88**

Codice-Code **00 1190**

**Le lampadine vengono fornite
solo su richiesta**

Bulbs supplied only
on request

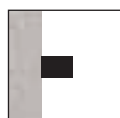

Installazione a parete
Wall mounting



Installazione a soffitto
Ceiling mounting

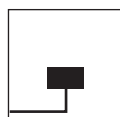

**Entrata singola
cavi di alimentazione**
Single power supply
cables input

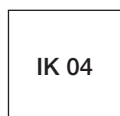

IK 04

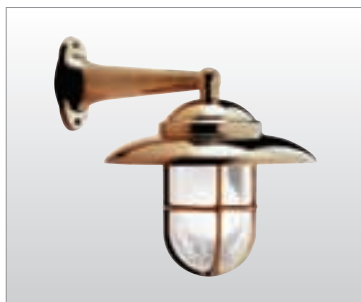

1190

1190.000  A60 75W E27



M85

M85.000  A60 60W E27

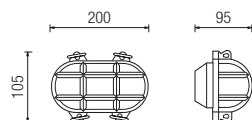

M86

M86.000  A60 60W E27

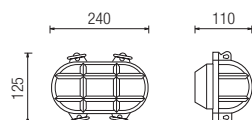

M87

M87.000  A60 60W E27

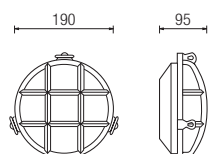

M88

M88.000  A60 75W E27

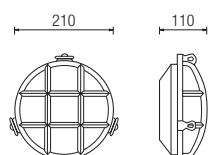





SLIM

SLIM

Apparecchio a parete o a soffitto per interni, disponibile in due dimensioni.

Costituito da:

- Supporto in metallo verniciato bianco
- Diffusore in materiale sintetico opalino (PMMA)

Il fissaggio del diffusore avviene tramite fermo rotante in plastica

Indoor wall or ceiling luminaire, available in two sizes.

Constructed of:

- Metal white painted support
- Opal syntetic diffuser (PMMA)

Diffuser must be fixed by using the plastic rotating lock



Colori - Colours

X=2 Bianco
White

Diffusore - Diffuser

Codice-Code 08 1404

Codice-Code 08 1406

Le lampadine vengono fornite solo su richiesta

Bulbs supplied only on request

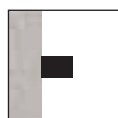

Installazione a parete
Wall mounting



Installazione a soffitto
Ceiling mounting

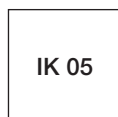



Lo spessore molto ridotto dell'apparecchio lo rende particolarmente adatto all'installazione su pareti
Le elevate potenze luminose garantiscono un effetto luminoso ottimale.

It can be easily adapted for wall fixing
The high power guarantees an excellent light effect



1404

1404.752  T16 24W G5
Con reattore elettronico / With electronic ballast

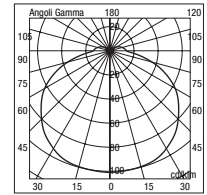
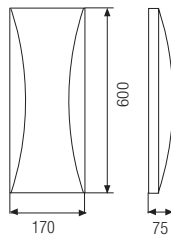

1404 75



1406

1406.752  T16 2X24W G5
Con reattore elettronico / With electronic ballast

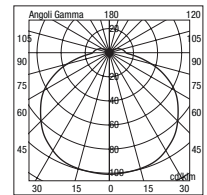
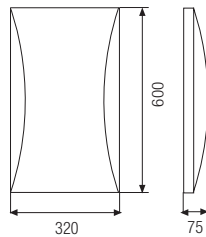

1406 75





BALL

FLAT



BALL

Apparecchio a sospensione per interni, disponibile in tre diverse dimensioni:

Ø 300 mm

Ø 350 mm

Ø 400 mm

Costituito da:

- Sfera in PMMA
- Cupola in metallo verniciato bianco
- Rosone in plastica
- Fune di acciaio e cavo di collegamento

Indoor suspended luminaire available in three different sizes:

Ø 300 mm

Ø 350 mm

Ø 400 mm

Costruito di:

- PMMA opal diffuser
- Metal white painted dome
- White plastic canopy
- Steel supporting rope and supply cable

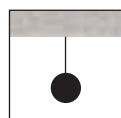

Installazione a sospensione
For suspended use

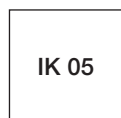

Diffusore - Diffuser

Codice-Code 08 9100

Codice-Code 08 9101

Codice-Code 08 9102

Le lampadine vengono fornite solo su richiesta

Bulbs supplied only on request

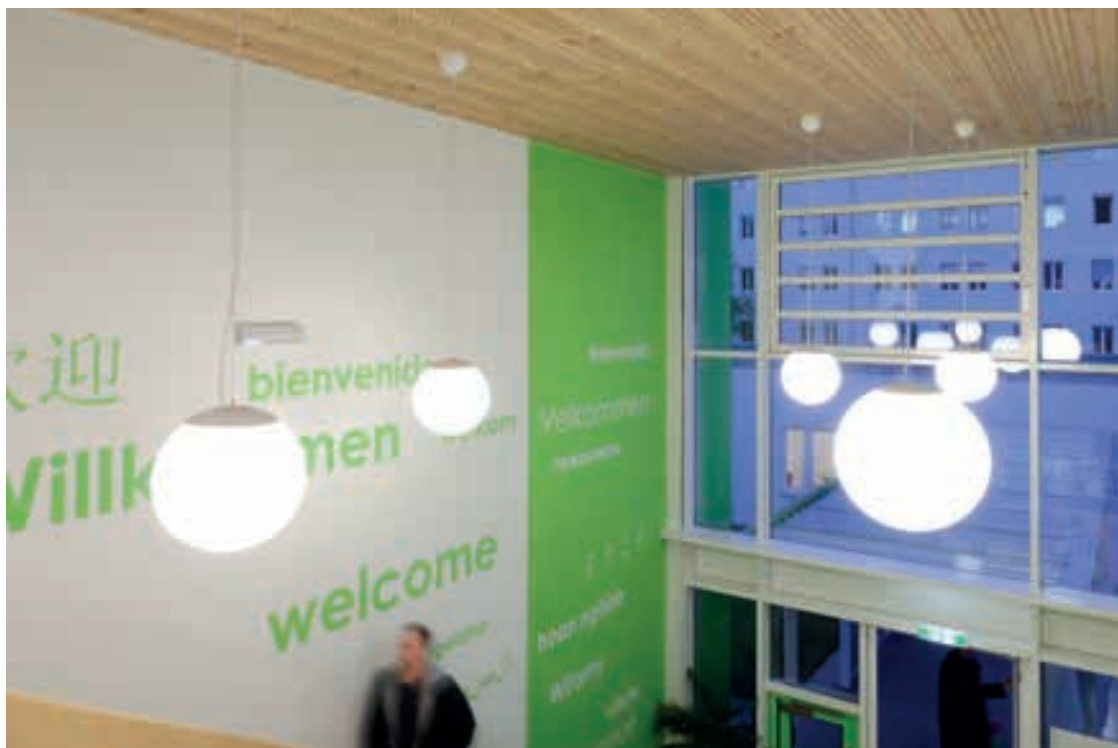



9100 Ø 300

Apparecchio Ø 300 mm - Luminaire Ø 300 mm

- **9100.842**  TC-TEL 18W GX24 q-2
- Con reattore elettronico / With electronic ballast

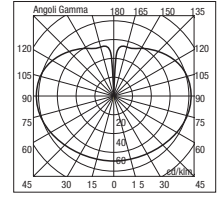
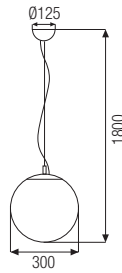

9100 842



9101 Ø 350

Apparecchio Ø 350 mm - Luminaire Ø 350 mm

- **9101.842**  TC-TEL 18W GX24 q-2
- Con reattore elettronico / With electronic ballast

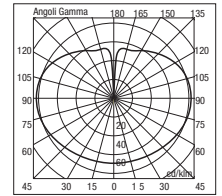
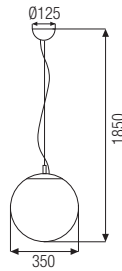

9101 842



9102 Ø 400

Apparecchio Ø 400 mm - Luminaire Ø 400 mm

- **9102.812**  TC-TEL 26/32W GX24 q-3-4
- Con reattore elettronico / With electronic ballast

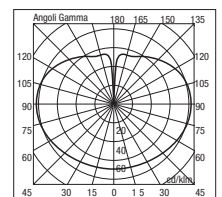
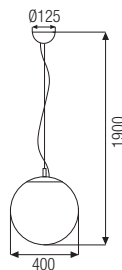

9102 842

FLAT

Apparecchio a parete o a soffitto per interni, disponibile in due diverse dimensioni:

- Ø 360 mm
- Ø 460 mm

Costituito da:

- Supporto in metallo verniciato bianco
- Diffusore in materiale sintetico opalino (PMMA)
- Morsetto a vite 4x2,5 mm²

Indoor wall or ceiling luminaire, available in two sizes:

- Ø 360 mm
- Ø 460 mm

Constructed of:

- Metal white painted support
- Opal syntetic diffuser (PMMA)
- Terminal type screw 4x2,5mm²



Diffusore - Diffuser

Codice-Code 08 1136

Codice-Code 08 1146

Le lampadine vengono fornite solo su richiesta

Bulbs supplied only on request

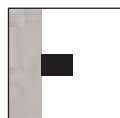

Installazione a parete
Wall mounting



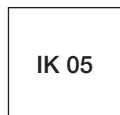

Installazione a soffitto
Ceiling mounting

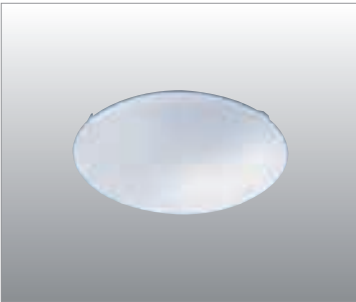
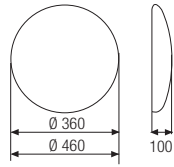



1136 Ø360

Apparecchio Ø 360 mm - Luminaire Ø 360 mm

- **1136.962**  TC-D 2X18W G24 q-2
- **1136.982**  TC-L 2X18W 2G11
- Con reattore elettronico / With electronic ballast

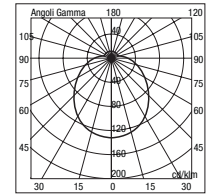

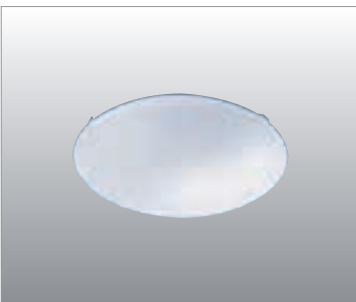

1136 96



1146 Ø460

Apparecchio Ø 460 mm - Luminaire Ø 460 mm

- **1146.952**  TC-D 2X26W G24 q-3
- **1146.982**  TC-L 2X18W 2G11
- Con reattore elettronico / With electronic ballast

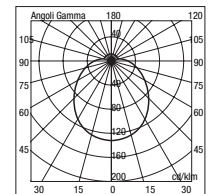

1146 95

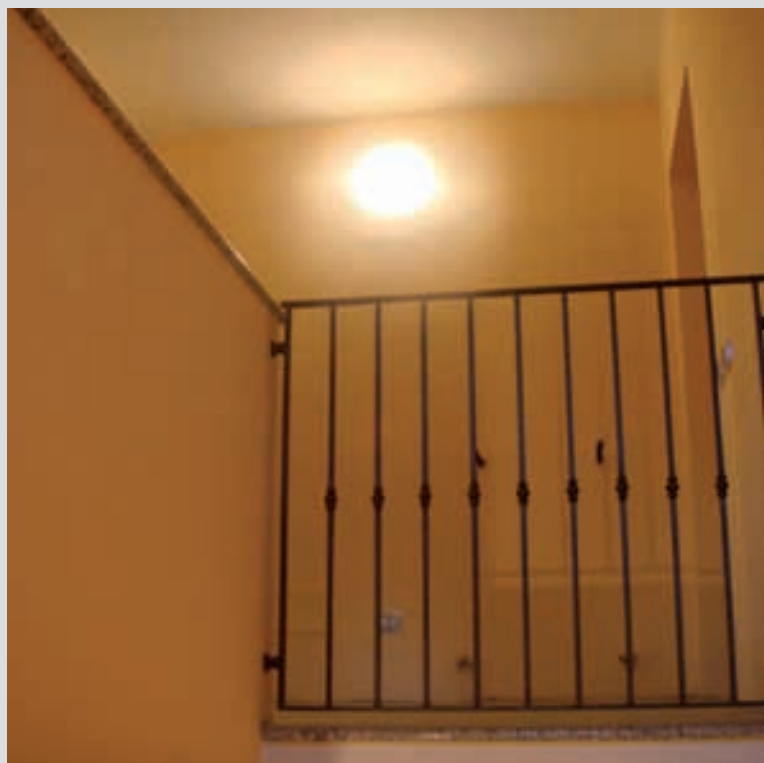



PERLA



PERLA

Plafoniera da soffitto o da parete
costituito da:

- Base in metallo verniciato bianco
- Anello in ABS UV
- Diffusore in vetro o in policarbonato

Ceiling or wall luminaire.

Costrutto di:

- White-painted metal base
- Self-extinguishing ABS UV
- Glass or polycarbonate diffuser



Colori - Colours

X=2  Bianco
White

X=3  Nero
Black

X=4  Silver

**Le lampadine vengono fornite
solo su richiesta**

Bulbs supplied only
on request

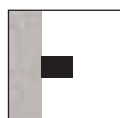

Installazione a parete
Wall mounting



Installazione a soffitto
Ceiling mounting

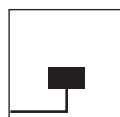

**Entrata singola
cavi di alimentazione**
Single power supply
cables input

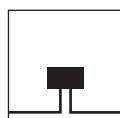

Cod. 0859 - 3081 - 9381
**Doppia entrata cavi
di alimentazione**
Double power supply
cable input

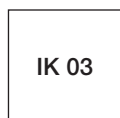

IK 03

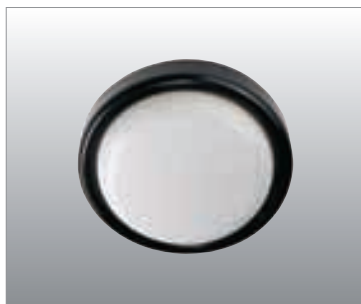

3018

Diffusore in policarbonato
Polycarbonate diffuser

3018.96X		TC-D	18W	G24 d-2
-----------------	--	------	-----	---------

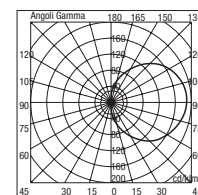
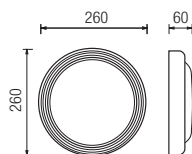

3018 96



9380

Diffusore in vetro o in policarbonato
Glass or polycarbonate diffuser

9380.00X		A60	75W	E27
9380.80X		TC	2x9W	G23
9380.96X		TC-D	18W	G24 d-2

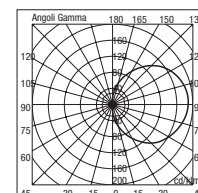
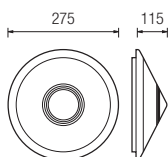

9380 00



9381

Diffusore in vetro
Glass diffuser

9381.00X		A60	2x60W	E27
9381.96X		TC-D	2x18W	G24 d-2
9381.95X		TC-D	2x26W	G24 d-3

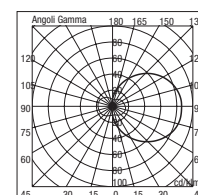
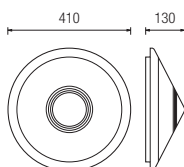

9381 00

Diffusori - Diffuser

Codice-Code	08 3019	per/for	Cod. 3018	Polic./Polyc.
Codice-Code	00 9380	per/for	Cod. 9380	Vetro/Glass
Codice-Code	08 9380	per/for	Cod. 9380	Polic./Polyc.
Codice-Code	00 9381	per/for	Cod. 9381	Vetro/Glass

PERLA

PERLA



0859

Diffusore in vetro Glass diffuser

0859.00X		A60	2x60W	E27
0859.96X		TC-D	2x18W	G24 d-2
0859.95X		TC-D	2x26W	G24 d-3

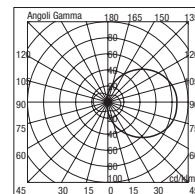
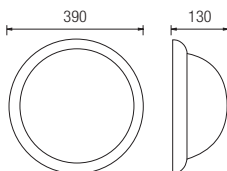

0859 00

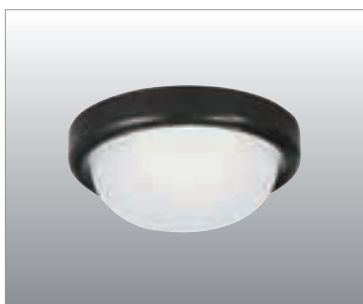

0860

Diffusore in vetro o in policarbonato Glass or polycarbonate diffuser

0860.00X		A60	75W	E27
0860.96X		TC-D	18W	G24 d-2

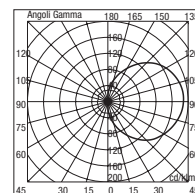
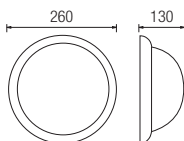

0860 00



0861

Diffusore in vetro Glass diffuser

0861.00X		C35	40W	E14
-----------------	--	-----	-----	-----

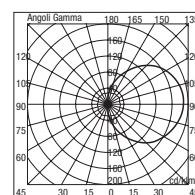
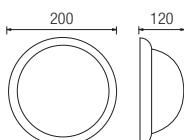

0861 00

Diffusori - Diffuser

Codice-Code	00 859	per/for	Cod. 0859	Vetro/Glass
Codice-Code	00 860	per/for	Cod. 0860	Vetro/Glass
Codice-Code	00 861	per/for	Cod. 0861	Vetro/Glass
Codice-Code	08 3020	per/for	Cod. 0860	Polic./Polyc.



3080

Diffusore in vetro a nido d'ape
Patterned glass diffuser

3080.00X		A60	75W	E27
3080.96X		TC-D	18W	G24 d-2

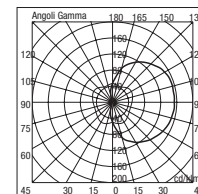
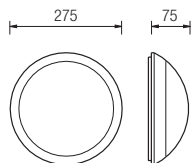

3080 00



3088

Diffusore in vetro o in policarbonato
Glass or polycarbonate diffuser

3088.00X		A60	75W	E27
3088.96X		TC-D	18W	G24 d-2

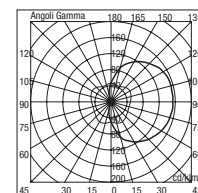
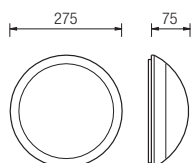

3088 00



3081

Diffusore in vetro a nido d'ape
Patterned glass diffuser

3081.00X		A60	2x60W	E27
3081.96X		TC-D	2x18W	G24 d-2
3081.95X		TC-D	2x26W	G24 d-3

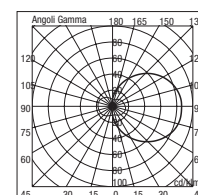
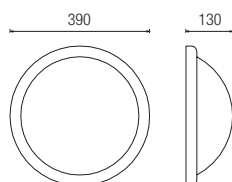

3081 00

Diffusori - Diffuser

Codice-Code	00 3080	per/for	Cod. 3080	Vetro a nido d'ape /Patterned glass
Codice-Code	00 3081	per/for	Cod. 3081	Vetro a nido d'ape /Patterned glass
Codice-Code	00 1000	per/for	Cod. 3088	Vetro liscio /Smooth glass
Codice-Code	08 1000	per/for	Cod. 3088	Polic. /Polyc.

Classificazione apparecchi Technical characteristics

Classificazione secondo l'infiammabilità del piano d'appoggio.
Classification on the basis of the flammability of the supporting surface.



L'apparecchio è idoneo all'installazione su superfici normalmente infiammabili (temperatura sulla base d'appoggio < 90°C).
The luminaire is suitable for mounting on normally flammable surfaces (temperature on supporting surface max. 90°C).



L'apparecchio non è idoneo all'installazione su superfici normalmente infiammabili.
The luminaire is unsuitable for mounting on normally inflammable surfaces.

Classificazione secondo il grado di isolamento elettrico.
Classification on the basis of the class of electrical insulation.

Classe I - Class I

Apparecchio con isolamento elettrico fondamentale. Deve essere collegato al circuito di terra dell'impianto elettrico generale.

Electrical device with basic electrical insulation. Must be connected to the ground circuit of the main electrical system.

Classe II - Class II



Apparecchio con doppio isolamento elettrico. Non necessita di collegamento al circuito di terra dell'impianto elettrico generale.
Electrical device with double insulation. Need not be connected to the ground circuit of the main electrical system.

Classe III - Class III



Apparecchio funzionante con bassissima tensione di alimentazione (12V, 24V).
Device working with very low voltage (12V, 24V).

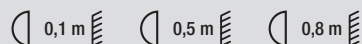

Distanza minima di installazione dagli oggetti illuminati.
Minimum distance from lighted objects.



CODICE IK Sistema di classificazione dei gradi di protezione degli involucri contro gli impatti meccanici.

IK CODE System for classifying the degrees of protection provided by the enclosure against mechanical impacts.

Energia di impatto (J) / Impact Energy (J)

IK01	IK02	IK03	IK04	IK05
0,15	0,2	0,35	0,5	0,7
IK06	IK07	IK08	IK09	IK10
1	2	5	10	20

Grado di protezione IP Protection index

Il grado di protezione degli apparecchi di illuminazione viene indicato dalla sigla IP (international protection) seguita da due cifre di cui, la prima indica il grado di protezione contro l'ingresso dei corpi solidi e la seconda dei liquidi. Esempio: IP54 indica che l'apparecchio ha protezione 5 contro la penetrazione di solidi e 4 contro la penetrazione d'acqua.
The degree of protection of light fixtures is indicated by the letters IP (international protection) followed by two figures, the first of which indicates the index of protection against the penetration of solid bodies and the second of liquids. For example: IP54 indicates that the device has an index of protection 5 against the penetration of solids and 4 against the penetration of water.

Protezione dai solidi - Prima cifra IP
Protection against solids - First IP figure

0 Non protetto
Not protected

1 Protetto dalla penetrazione di corpi solidi di dimensioni maggiori a 50 mm
Protected against penetration of solid bodies measuring more than 50 mm

2 Protetto dalla penetrazione di corpi solidi di dimensioni maggiori a 12 mm
Protected against penetration of solid bodies measuring more than 12 mm

3 Protetto dalla penetrazione di corpi solidi di dimensioni maggiori a 2,5 mm
Protected against penetration of solid bodies measuring more than 2.5 mm

4 Protetto dalla penetrazione di corpi solidi di dimensioni maggiori a 1 mm
Protected against penetration of solid bodies measuring more than 1 mm

5 Protetto contro la polvere
Protected against dust

6 Stagno contro la polvere
Sealed against dust

Protezione dai liquidi - Seconda cifra IP
Protection against liquids - Second IP figure

0 Non protetto
Not protected

1 Protetto contro gocce d'acqua che cadono verticalmente
Protected against drops of water falling vertically

2 Protetto contro gocce d'acqua che cadono con inclinazione massima di 15°
Protected against drops of water falling with a maximum angle of 15°

3 Protetto contro la pioggia
Protected against rain

4 Protetto contro gli spruzzi
Protected against splashes

5 Protetto contro i getti d'acqua
Protected against jets of water

6 Protetto contro le ondate
Protected against waves

7 Protetto contro l'immersione
Protected against immersion

8 Protetto contro la sommersione
Protected against submersion

Omologazioni Quality marking

Marcatura CE
CE marking



Tutti I prodotti sono conformi alle norme EN 60598-1 e alle parti seconde applicabili nonché alle norme EMC applicabili.

La marcatura CE, applicata sugli articoli, testimonia la conformità alle direttive Europee: 73/23 CEE, 93/68 CE, 2006/95/CE (direttiva di bassa tensione)

89/336 CEE, 93/68 CE, 2004/108/CE

(direttiva di compatibilità elettromagnetica).

All the products are in compliance to EN 60598-1 and part two applicable standards and to EMC applicable standards.

The CE marking, applied on the products, certify their conformity with the European directives:

73/23 CEE, 93/68 CE, 2006/95/CE

(Low Voltage Directive).

89/336 CEE, 93/68 CE, 2004/108/CE

(Electromagnetic Compatibility Directive).

RoHs

Apparecchi conformi alla direttiva 2002/95 RoHs (direttiva sulla restrizione dell'uso di sostanze pericolose).

Appliances in compliance to directive 2002/95 RoHs (directive on the restriction of the use of certain hazardous substances).

RAEE

Gli apparecchi devono essere smaltiti a fine vita conformemente a quanto prescritto dalla direttiva 2002/96/CE RAEE e successive modificazioni (direttiva sui rifiuti di apparecchiature elettriche ed elettroniche).

At the end of their life, the appliances shall be disposed according to the requirements of 2002/96/EC WEEE and its amendments (directive on waste of electrical and electronic equipment).

Norma tecnica CEI EN 60598-2-13 per apparecchi interrati

Il significato della numerazione riportata nel catalogo, a fianco dei dati di lampada degli apparecchi interrati, è derivato dalla "GUIDA ALLA BUONA INSTALLAZIONE" riportata nell'allegato A della norma EN 60598-2-13.

Si invita l'installatore a consultare e tenere in considerazione tale norma nonché le norme di impianto applicabili e vigenti.

ZONA 1 - Impiego previsto nelle aree normalmente non accessibili (in conformità alle Norme Impianti)

ZONA 2 - In aree ad accesso limitato (ad esempio riservate ai pedoni e ai ciclisti)

ZONA 3 - In tutte le altre aree accessibili (ad esempio su vie carrabili, parcheggi, etc.)

ZONA 4 - Come sopra, ma in aree in cui sono utilizzati spazzaneve e/o agenti decongelanti

ZONA 5 - In aree particolari (in cui le temperature di funzionamento possono provocare lesioni, ad esempio in ambienti per bambini, etc.).

Standard CEI EN 60598-2-13 for ground recessed luminaires

The meaning of numbering in the catalogue besides of the lamp rating of the ground recessed luminaires is derived from the "GUIDE TO GOOD INSTALLATION PRACTICE" in the annex A of the EN 60598-2-13.

Installer is strongly required to consult and take into account that standard as well as the electrical installation of building applicable and in force standards.

ZONE 1 - In normally non-accessible areas (according to Wiring Rules)

ZONE 2 - In restricted accessible areas (e.g. pedestrians and pedal cycles only)











ZONE 3 - In all other accessible areas (e.g. carriageways, parkings, etc.)











ZONE 4 - As above, but in areas for snow-ploughs and / or de-icing agents









ZONE 5 - In particular areas (where working temperatures may cause injuries, e.g. nurseries, etc.)

LEGENDA

LEGEND

	Potenza Power W	Tensione Voltage V	Flusso Lum. Lum. Flux lm	Intensità Lum. Lum. Intensity cd	Attacco Socket
 Incandescenza Incandescent	A60	40	/	430	E27
		60	/	730	E27
		75	/	950	E27
		100	/	1380	E27
	A65	150	/	2220	E27
 Incandescenza Incandescent	C35	15	/	90	E14
		25	/	200	E14
		40	/	400	E14
		60	/	660	E14
 Incandescenza Incandescent	R80 80°	100	/	500	E27
 Alogena Halogen	PAR 38 Spot 12°	80	/	5400	E27
		120	/	9300	E27
	PAR 38 Flood 30°	80	/	1800	E27
		120	/	3100	E27
 Alogena Halogen	QT9	20	12	320	G4
 Alogena Halogen	QT12	35	12	600	GY6.35
		50	12	930	GY6.35
		75	12	1300	GY6.35
		100	12	2400	GY6.35
 Alogena HALOPIN Halogen	QT14	25	/	260	G9
		40	/	490	G9
		60	/	820	G9
		75	/	1100	G9
 QR70 Alogena bassa tensione Halogen	SP a 8°	50	12	12500	BA15d
	FL a 24°	50	12	2600	BA15d
 QR111 Alogena bassa tensione Halogen	Superspot SP a 8°	75	12	30000	G53
	Superspot FL a 24°	75	12	5300	G53
	Superspot WFL a 45°	75	12	1700	G53
	Superspot WFL a 24°	100	12	8500	G53
 Alogena Halogen	QPAR16 25°	40	/	950	E14
	QPAR20 Spot	50	/	3000	E27
	QPAR20 Flood	50	/	1000	E27
	QPAR30 Spot	75	/	6900	E27
	QPAR30 Flood	75	/	2200	E27
 Alogena Halogen	QT-DE12	60	/	840	R7s-15
		100	/	1650	R7s-15
		200	/	3200	R7s-15
		300	/	5000	R7s-15

	Potenza Power W	Tensione Voltage V	Flusso Lum. Lum. Flux lm	Intensità Lum. Lum. Intensity cd	Attacco Socket
 Alogena Halogen	QT32	60	/	820	E27
		75	/	1100	E27
		100	/	1500	E27
		150	/	2500	E27
		250	/	4200	E27
 Alogena Halogen	QR-CBC51 38°	20	12	550	GU5,3
		35	12	1000	GU5,3
		50	12	1600	GU5,3
	QR-CBC35	10	12	300	GU4
 Alogena Halogen	QPAR16 25°	35	/	1200	GU10
		50	/	1150	GU10
 Fluorescente Compact Fluorescent	TC	7	/	400	G23
		9	/	600	G23
		11	/	900	G23
 Fluorescente Compact Fluorescent	TC-D	10	/	600	G24 d-1
		13	/	900	G24 d-1
		18	/	1200	G24 d-2
		26	/	1800	G24 d-3
	TC-DEL	13	/	900	G24 q-1
		18	/	1200	G24 q-2
	26	/	1800	G24 q-3	
 Fluorescente Compact Fluorescent	TC-L	18	/	1200	2G11
		24	/	1800	2G11
		36	/	2900	2G11
 Fluorescente Compact Fluorescent	TC-T	13	/	900	Gx24 d-1
		18	/	1200	Gx24 d-2
		26	/	1800	Gx24 d-3
	TC-TEL	13	/	900	Gx24 q-1
		18	/	1200	Gx24 q-2
	26	/	1800	Gx24 q-3	
	32	/	2400	Gx24 q-3	
	42	/	3200	Gx24 q-4	
	57	/	4300	Gx24 q-5	
	70	/	5200	Gx24 q-6	
 Fluorescente Compact Fluorescent	TC-F	18	/	1100	2G10
		24	/	1700	2G10
		36	/	2800	2G10
 Fluorescente Compact Fluorescent	T5	8	/	450	G5
		13	/	970	G5
		14	/	1200	G5
		21	/	1900	G5
		28	/	2600	G5
 Fluorescente Compact Fluorescent		35	/	3300	G5
	T16	8	/	450	G5
		24	/	1750	G5

	Potenza Power W	Tensione Voltage V	Flusso Lum. Lum. Flux lm	Intensità Lum. Lum. Intensity cd	Attacco Socket
 <p>Vapori di mercurio A.P. High-pressure mercury-vapour</p>	HME	50	/	2000	E27
		80	/	4000	E27
		125	/	6500	E27
 <p>Alogenuri metallici Metal-halide</p>	HIT	35	/	3400	G12
		70	/	6600	G12
		150	/	14000	G12
 <p>Alogenuri metallici Metal-halide</p>	HIT-DE	70	/	5500	RX7s
		150	/	11250	RX7s-24
 <p>Alogenuri metallici Metal-halide</p>	HIT-TC	20	/	1700	G8,5
 <p>Alogenuri metallici Metal-halide</p>	HIE	70	/	4900	E27
		100	/	8000	E27
		150	/	12000	E27
 <p>Vapori di sodio A.P. High-pressure sodium-vapour</p>	HSE	50	/	3500	E27
		70	/	5600	E27
		100	/	9500	E40
 <p>Fluorescente Reattore elettronico incorporato Compact Fluorescent Built-in electronic ballast</p>	T2	6	/	220	Gx53
		9	/	280	Gx53
		13	/	380	Gx53
 <p>21 LED bianco white clear</p>	T2	1,5	/	40	Gx53
 <p>60 LED bianco white clear</p>		4	/	260	Gx53

INDICE

INDEX

codice	pagina	codice	pagina	codice	pagina	codice	pagina
0859	372	1034	121	1087	206	1680	257
0860	372	1035	121	1088	206	1681	257
0861	372	1036	121	1089	206	1780	209
0900	345	1037	121	1090	123	1781	209
0901	345	1038	121	1091	123	1782	211
0902	345	1039	121	1092	123	1783	211
0903	345	1040	163	1093	124	1800	251
0904	345	1041	163	1094	124	1801	251
0905	345	1042	163	1095	125	1840	251
0912	345	1043	163	1096	125	1841	251
0913	345	1045	87	1097	125	2000	293
1000	312	1046	163	1099	124	2001	293
1001	312	1047	163	1136	367	2002	293
1002	312	1048	163	1146	367	2003	291
1003	311	1049	163	1180	207	2004	291
1004	311	1050	163	1181	207	2005	295
1005	311	1051	163	1182	207	2006	295
1006	314	1052	163	1183	207	2007	295
1007	314	1053	163	1190	357	2008	291
1008	314	1054	163	1270	156	2009	291
1009	325	1055	163	1271	156	2010	197
1010	123	1057	87	1272	156	2011	197
1011	124	1060	325	1273	156	2015	111
1012	163	1061	325	1274	156	2016	111
1014	163	1062	325	1275	156	2020	197
1015	111	1070	155	1380	256	2024	197
1016	111	1071	155	1381	256	2030	267
1018	163	1072	155	1404	361	2031	267
1019	163	1073	156	1406	361	2032	267
1020	168	1074	156	1414	107	2034	267
1021	168	1075	156	1415	107	2035	267
1022	168	1078	159	1416	107	2036	267
1023	169	1079	159	1418	107	2037	267
1026	163	1080	205	1420	107	2039	267
1027	163	1081	205	1478	159	2040	199
1028	111	1082	205	1479	159	2041	199
1030	167	1083	205	1580	255	2050	199
1031	167	1084	173	1581	255	2054	199
1032	167	1085	173	1618	305	2060	145
1033	169	1086	206	1620	305	2061	145

codice	pagina
2062	146
2063	147
2066	146
2067	145
2068	145
2070	157
2071	157
2072	157
2074	157
2075	157
2080	231
2081	231
2083	231
2092	233
2093	233
2094	234
2095	234
2096	233
2097	233
2098	234
2099	234
2100	283
2101	283
2102	283
2160	146
2166	146
2167	146
2168	146
2210	201
2211	201
2220	201
2224	201
2240	201
2241	201
2250	201
2254	201
2260	147
2261	147
2262	147
2266	147

codice	pagina
2267	147
2268	147
2360	147
2366	147
2367	147
2368	147
2400	287
2401	287
2610	262
2611	262
2612	263
2614	263
2615	263
2616	261
2618	261
2619	263
2810	273
2811	273
2812	273
3000	342
3001	342
3011	271
3012	342
3015	271
3017	271
3018	371
3019	339
3020	339
3021	339
3022	339
3031	31
3032	31
3033	31
3034	32
3035	33
3036	33
3038	33
3040	309
3041	309
3042	309

codice	pagina
3050	219
3051	219
3052	219
3056	219
3060	148
3061	148
3066	149
3067	148
3068	148
3070	97
3071	97
3072	97
3073	97
3080	373
3081	373
3082	319
3083	319
3084	319
3085	319
3088	373
3090	115
3091	115
3160	149
3166	149
3167	149
3168	149
3176	98
3178	98
3276	98
3278	98
3905	342
4000	341
4001	341
4011	130
4012	130
4014	130
4015	130
4018	129
4019	129
4020	340

codice	pagina
4021	340
4022	340
4023	340
4031	29
4032	29
4033	29
4040	17
4046	17
4050	215
4051	215
4060	215
4061	215
4070	151
4071	151
4076	151
4080	227
4082	227
4084	227
4086	227
4088	227
4090	103
4091	103
4092	103
4094	103
4270	152
4271	152
4276	152
4470	153
4471	153
4476	153
4811	115
4815	115
4913	341
5010	81
5014	85
5015	85
5016	85
5020	239
5021	240
5022	240

INDICE

INDEX

codice	pagina	codice	pagina	codice	pagina	codice	pagina
5024	89	6018	135	7030	183	8034	277
5025	89	6019	135	7031	183	8040	223
5026	89	6020	13	7033	183	8041	223
5028	240	6021	13	7036	183	8042	223
5030	239	6022	13	7040	245	8046	223
5031	240	6024	13	7041	245	8050	117
5032	240	6041	55	7042	245	8051	116
5040	231	6042	55	7071	59	8052	117
5041	231	6043	56	7072	59	8053	116
5043	231	6044	55	7074	59	8054	117
5050	189	6045	56	7076	60	8055	116
5054	93	6046	56	7077	60	8071	43
5056	93	6048	57	7078	60	8072	43
5058	93	6060	19	7080	246	8073	43
5062	233	6061	23	7081	246	8074	44
5063	233	6062	23	7180	247	8077	44
5064	234	6063	23	7181	247	8080	193
5065	234	6064	23	7230	184	8081	41
5066	233	6065	23	7231	184	8082	41
5067	233	6066	23	7233	184	8083	41
5068	234	6071	25	7236	184	8090	193
5069	234	6072	25	7280	247	8091	51
5070	179	6073	25	7281	247	8092	51
5072	179	6074	25	7380	246	8093	51
5074	177	6075	25	7381	246	8130	279
5080	141	6076	25	7430	185	8131	279
5081	141	6810	134	7431	185	8132	279
5082	141	6811	134	7433	185	8133	279
5090	143	6812	134	7436	185	8134	279
5091	143	6814	134	8010	313	8140	221
5092	181	7011	77	8011	313	8141	221
5093	181	7012	77	8012	313	8142	221
5094	139	7013	77	8021	49	8146	221
6000	341	7014	77	8022	49	9000	329
6010	133	7017	77	8023	49	9001	329
6011	133	7021	37	8024	49	9008	329
6012	133	7022	37	8030	277	9010	329
6014	133	7024	37	8031	278	9011	343
6015	135	7025	37	8032	278	9014	343
6016	135	7027	77	8033	278	9015	71

codice	pagina
9016	71
9017	71
9018	71
9020	330
9021	330
9022	330
9023	330
9024	73
9025	73
9026	73
9030	335
9031	335
9032	335
9033	335
9034	335
9035	343
9036	343
9037	343
9039	299
9040	299
9041	299
9042	299
9043	300
9044	300
9045	300
9046	300
9047	301
9048	301
9050	351
9051	351
9052	351
9061	68
9062	68
9064	68
9067	68
9070	65
9071	67
9072	67
9075	67
9076	67

codice	pagina
9077	67
9080	353
9085	71
9086	71
9087	73
9088	71
9090	349
9091	349
9092	349
9094	72
9095	72
9096	72
9097	72
9100	365
9101	365
9102	365
9245	300
9246	300
9247	301
9248	301
9320	323
9321	323
9322	323
9324	323
9325	323
9380	371
9381	371
M85	357
M86	357
M87	357
M88	357

ACCESSORI / ACCESSORIES

codice	pagina	codice	pagina
7730	182	7790	158
7737	182	7797	158
7738	182	7798	158
7739	182	7799	158
7740	150	CP20	232-238
7747	150	CP26	260
7748	150	CP70	208
7749	150	CP80	204
7757	142	CP90	244-298-328
7758	142	GR60	144
7759	142	GR70	154
7767	180	GR78	158
7768	180	PT74	30
7769	180	PT76	58
7777	154	S80	235
7778	154	S90	235
7779	154		
7780	154		



MADE IN ITALY

**Il presente catalogo non può essere riprodotto neppure parzialmente. Tutti i diritti sono riservati.
Le fotografie, la descrizione degli apparecchi, le quote, le dimensioni ed i valori fotometrici menzionati in questo catalogo
sono a titolo indicativo e non costituiscono alcun impegno per la nostra società,
che si riserva di apportare, senza preavviso, tutte le modifiche che riterrà opportune.
I prodotti presenti in questo catalogo sono REGISTRATI.**

No part of this catalogue may be reproduced. All rights reserved.
The pictures, the description of the fittings, the heights, dimensions and photometric values mentioned in this catalogue
are approximate and do not constitute any commitment on our part, and we reserve the right
to make any modifications we consider appropriate without prior notice.
The products in this catalogue are PATENTED.

**Questo catalogo è stato stampato secondo la filosofia GreenPrinting®
volta alla salvaguardia dell'ambiente attraverso l'uso di materiali
(lastre, carta, inchiostri e imballi) a basso impatto ambientale,
oltre all'utilizzo di energia rinnovabile e automezzi a metano.**

This catalogue has been printed in accordance with the GreenPrinting®
philosophy, aimed at protecting the environment via the use of
materials (plates, paper, ink and packaging) with a low
environmental impact, as well as the use of renewable energy sources
and vehicles fuelled by natural gas.

BOLUCE[®]
ILLUMINAZIONE

BOLUCE ILLUMINAZIONE s.r.l.

24033 CALUSCO D'ADDA (BG) ITALY

Via Francesco Nullo, 360

Tel. +39 035 791234 - Fax +39 035 790424

www.boluce.com - info@boluce.com