

Elements

Essential Outdoor Lighting



July 2014

The Elements range is the perfect starting point for many landscape lighting projects. With a wide choice of luminaires, construction materials and lamp options, the Elements range is a practical and flexible product family that can be utilised alongside many different architectural styles and landscape settings.

AWL-03 Wall Light.....	3	AWL-05-CP Copper Adjustable Light	13
AWL-05 Adjustable Wall Light	4	AWL-06-CP Fixed Copper Wall Light.....	14
AWL-06 Fixed Wall Light	5	ABL-01-CP Pathlight	15
ASL-05 Hooded Spotlight.....	6	AUL-02-CP Copper Uplight	17
ASL-04 IP68 Spotlight	7	ABL-01-BR-LED Pathlight	18
AWL-01 Step Light.....	8	ASL-01-BR Brass Spotlight.....	19
AUL-02 Spotlight.....	9	AUL-03-BR Brass Recessed Uplight	20
AUL-03 Recessed Uplight	10	AUL-04-BR Brass Recessed Uplight	21
AUL-04 Recessed Uplight	11	AWL-02-BR Steplight	22
AWL-03-CP Copper Wall Light.....	12	AWL-01-BR Steplight	23

Luminaire Material Selection

Stainless Steel

Stainless Steel 304 & 316 options are available in many Element models, complimenting more modern gardens and offering good durability in a variety of locations. If your project is near the coast or a water source, it's good to consider selecting 316-grade Stainless Steel. All stainless steel product may "tea-stain" over time without regular maintenance.



Pure Copper

Copper is a time-tested material for many outdoor applications and lighting is no exception. The copper used in the Elements range is un-coated or varnished, meaning it will naturally oxidize to a dark brown/green patina over time. How long this takes depends on how exposed the fitting is to the weather.



Brass

Brass, as an alloy of copper and zinc, features many of the same benefits as copper with increased hardness and mechanical stability. Brass will also age when exposed to the environment, however some Elements brass models are available in "Aged Brass" meaning that they have been through an accelerated aging process. This delivers the structural stability of brass without the change in appearance over time.



Australian Quality

The Elements range is 100% quality-controlled in Australia. We ensure that no light leaves our factory without having undergone a thorough quality check and any necessary improvements are made before the light is shipped.

Aqualux Lighting

Lighting is fundamental to how we perceive the world around us - it enables us to see, it impacts our productivity and it can even alter our mood. Effective lighting in an outdoor area can transform a dark and disused night time garden into a functional after-dark space of subtle beauty and functionality. The art of effective illumination is a combination of skill and experience yet it is also critical to select the best product for the application.

Aqualux Lighting was started from the desire to introduce to the market a range of premium quality outdoor luminaires suitable for both the architectural and residential markets. Through a combination of attention to detail and a desire to respond to the needs of the market and the installers of our fittings, we have developed a series of product families that represent the best available products in their class.

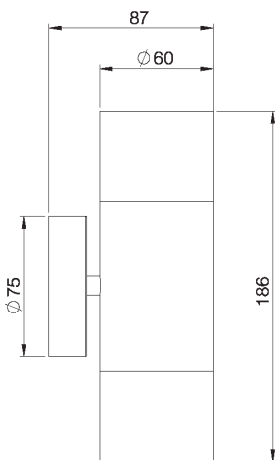

	AWL-03-SS	
	AWL-03-SS-316	
PRODUCT CODES	AWL-03-SS-316-240	
PRODUCT FAMILY	Elements	
MOUNTING	Surface / Wall Mount	
	AWL-03-SS	Stainless Steel 304
	AWL-03-SS-316	Stainless Steel 316
CONSTRUCTION	AWL-03-SS-316-240 Stainless Steel 316	
	AWL-03-SS	GU5.3 SELV
	AWL-03-SS-316	GU5.3 SELV
ELECTRICAL	AWL-03-SS-316-240 GU10 240VAC	
CABLE	200mm Twin Lead	
IP RATING	IP65	
WARRANTY	Aqualux 2-Year Limited Warranty	
ADDITIONAL		

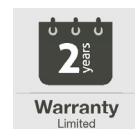
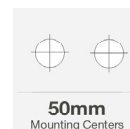



	AWL-05-SS	
	AWL-05-SS-316	
PRODUCT CODES	AWL-05-SS-316-240	
PRODUCT FAMILY	Elements	
MOUNTING	Surface / Wall Mount Adjustable	
	AWL-05-SS	Stainless Steel 304
	AWL-05-SS-316	Stainless Steel 316
CONSTRUCTION	AWL-05-SS-316-240 Stainless Steel 316	
	AWL-05-SS	GU5.3 SELV
	AWL-05-SS-316	GU5.3 SELV
ELECTRICAL	AWL-05-SS-316-240 GU10 240VAC	
CABLE	200mm Twin Lead	
IP RATING	IP65	
WARRANTY	Aqualux 2-Year Limited Warranty	
ADDITIONAL		

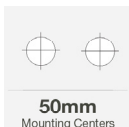
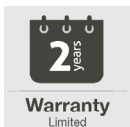
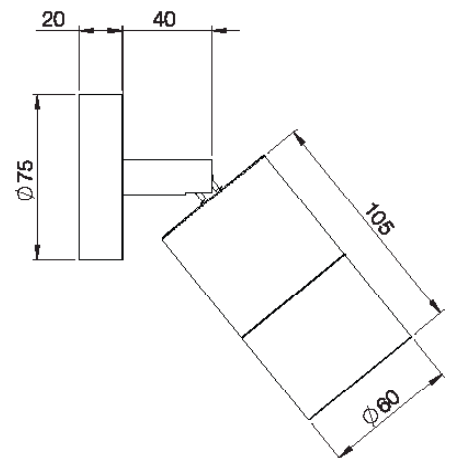

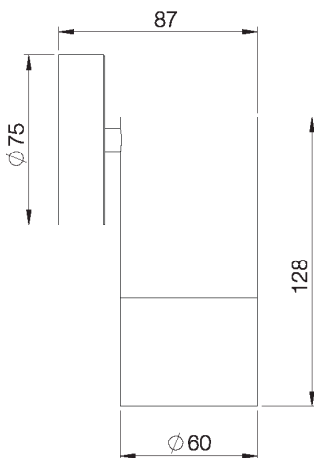

PRODUCT CODES	AWL-06-SS-316 AWL-06-SS-316-240	
PRODUCT FAMILY	Elements	
MOUNTING	Surface / Wall Mount Fixed	
CONSTRUCTION	AWL-06-SS-316 AWL-06-SS-316-240	Stainless Steel 316 Stainless Steel 316
ELECTRICAL	AWL-06-SS-316 AWL-06-SS-316-240	GU5.3 SELV GU10 240VAC
CABLE	200mm Twin Lead	
IP RATING	IP65	
WARRANTY	Aqualux 2-Year Limited Warranty	
ADDITIONAL		

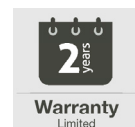
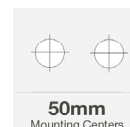



PRODUCT CODES	ASL-05-SS	
PRODUCT FAMILY	Elements	
MOUNTING	Surface / Wall Mount	
CONSTRUCTION	ASL-05-SS	Stainless Steel 304
ELECTRICAL	ASL-05-SS	GU5.3 SELV
CABLE	200mm Twin Lead	
IP RATING	IP65	
WARRANTY	Aqualux 2-Year Limited Warranty	
ADDITIONAL		

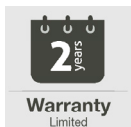
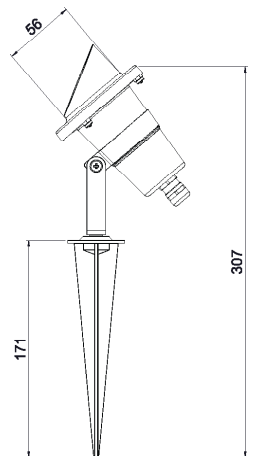

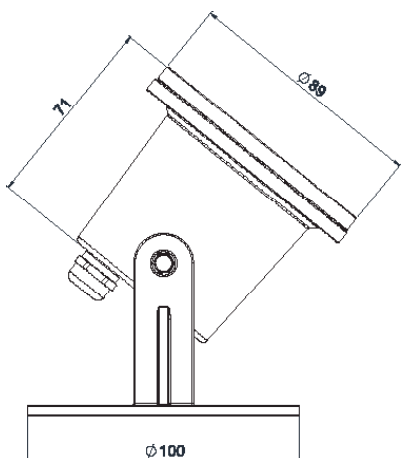
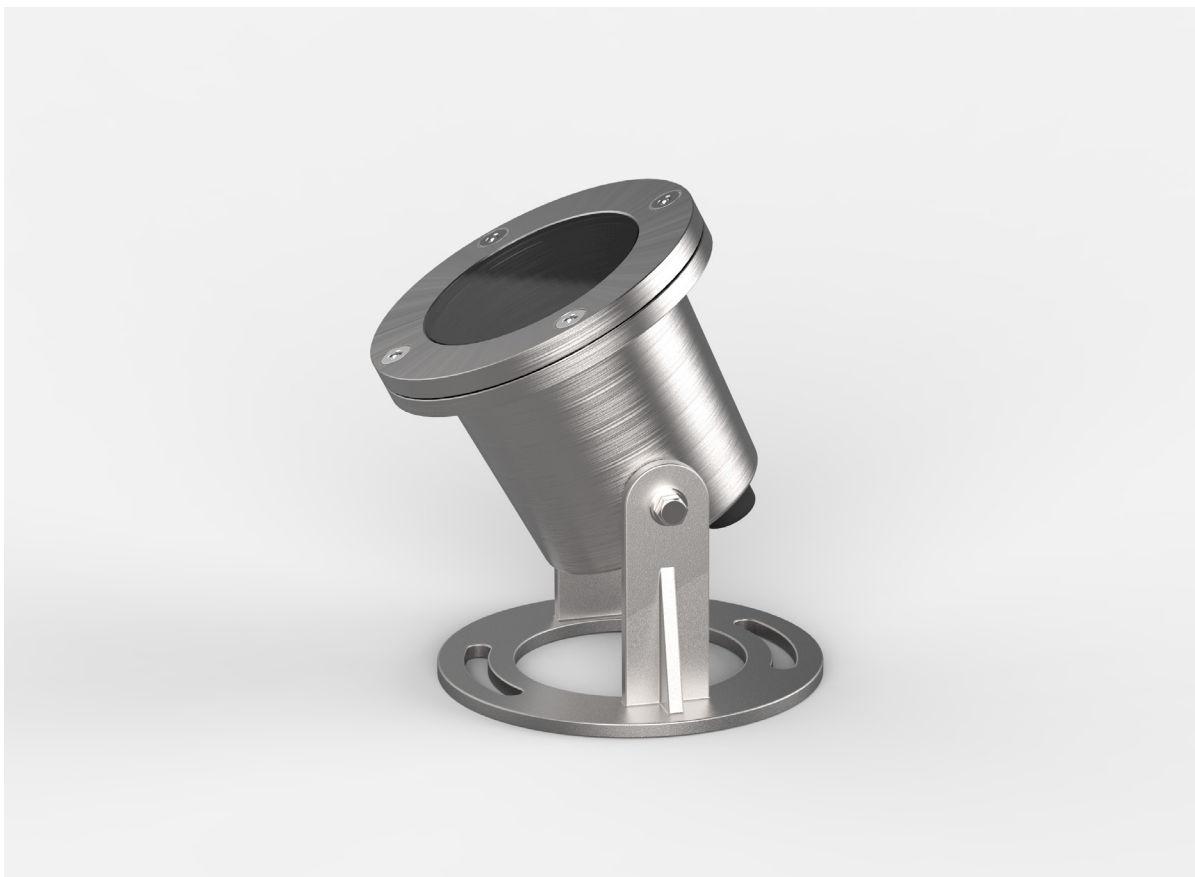

	ASL-04-SS	
PRODUCT CODES	ASL-04-SS-316	
PRODUCT FAMILY	Elements	
MOUNTING	Surface Mount Spot	
	ASL-04-SS	Stainless Steel 304
CONSTRUCTION	ASL-04-SS-316	Stainless Steel 316
	ASL-04-SS	GU5.3 SELV
ELECTRICAL	ASL-04-SS-316	GU5.3 SELV
CABLE	4M Twin Core	
IP RATING	IP68	
WARRANTY	Aqualux 2-Year Limited Warranty	
ADDITIONAL	Longer lead available	

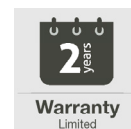



AWL-01 Step Light



PRODUCT CODES	AWL-01-SS-316	
PRODUCT FAMILY	Elements	
MOUNTING	Surface Mount Steplight	
CONSTRUCTION	AWL-01-SS	Stainless Steel 316
ELECTRICAL	AWL-01-SS	GU4 JC-Type SELV
CABLE	200mm Twin Lead	
IP RATING	IP65	
WARRANTY	Aqualux 2-Year Limited Warranty	
ADDITIONAL	12~24V CREE LED Option	

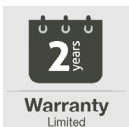
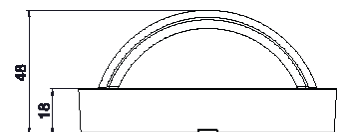
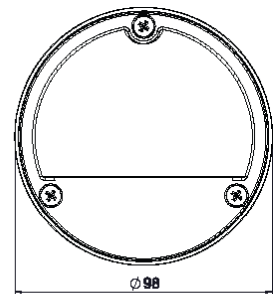

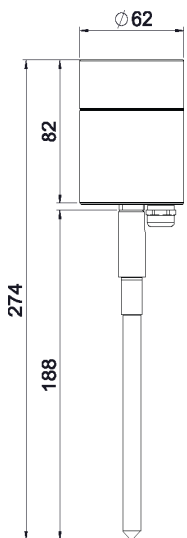

PRODUCT CODES	AUL-02-SS AUL-02-SS-316	
PRODUCT FAMILY	Elements	
MOUNTING	Spike Spot	
CONSTRUCTION	AUL-02-SS	Stainless Steel 304
	AUL-02-SS-316	Stainless Steel 316
ELECTRICAL	AUL-02-SS	GU5.3 SELV
	AUL-02-SS-316	GU5.3 SELV
CABLE	200mm Twin Lead	
IP RATING	IP65	
WARRANTY	Aqualux 2-Year Limited Warranty	
ADDITIONAL	600mm Extension Available	

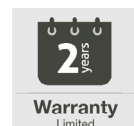



PRODUCT CODES	AUL-03-SS-316	
PRODUCT FAMILY	Elements	
MOUNTING	Recessed Uplight	
CONSTRUCTION	AUL-03-SS-316	Stainless Steel 316
ELECTRICAL	AUL-03-SS-316	GU5.3 SELV
CABLE	200mm Twin Lead	
IP RATING	IP65	
WARRANTY	Aqualux 2-Year Limited Warranty	
ADDITIONAL		

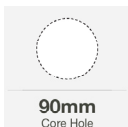
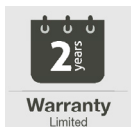
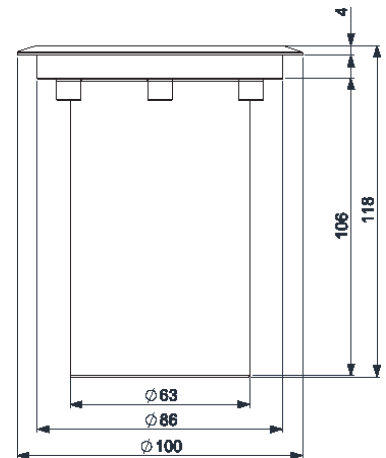

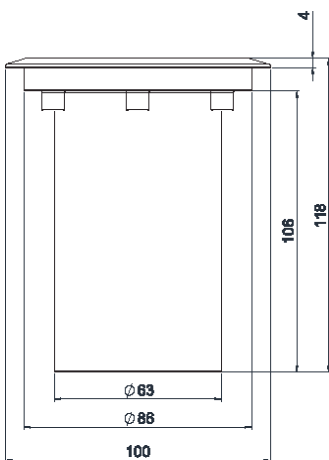

PRODUCT CODES	AUL-04-SS-316	
PRODUCT FAMILY	Elements	
MOUNTING	Square Recessed Uplight	
CONSTRUCTION	AUL-04-SS-316	Stainless Steel 316
ELECTRICAL	AUL-04-SS-316	GU5.3 SELV
CABLE	200mm Twin Lead	
IP RATING	IP65	
WARRANTY	Aqualux 2-Year Limited Warranty	
ADDITIONAL		

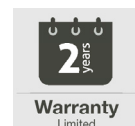
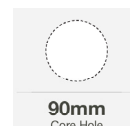



AWL-03-CP Copper Wall Light



	AWL-03-CP
PRODUCT CODES	AWL-03-CP-240
PRODUCT FAMILY	Elements
MOUNTING	Surface / Wall Mount

	AWL-03-CP	Pure Copper
CONSTRUCTION	AWL-03-CP-240	Pure Copper

	AWL-03-CP	GU5.3 SELV
ELECTRICAL	AWL-03-CP-240	GU10 240VAC

CABLE	200mm Twin Lead
-------	-----------------

IP RATING	IP65
-----------	------

WARRANTY	Aqualux 2-Year Limited Warranty
----------	---------------------------------

ADDITIONAL	
------------	--

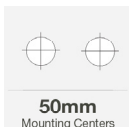
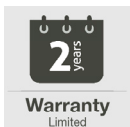
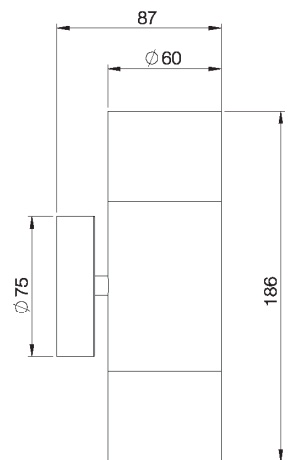

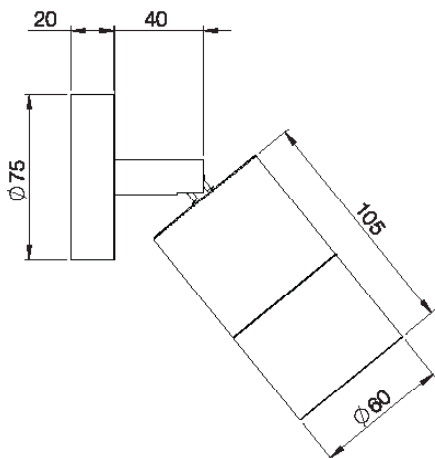

	AWL-05-CP	
PRODUCT CODES	AWL-05-CP-240	
PRODUCT FAMILY	Elements	
MOUNTING	Surface / Wall Mount Adjustable	
	AWL-05-CP	Pure Copper
CONSTRUCTION	AWL-05-CP-240	Pure Copper
	AWL-05-CP	GU5.3 SELV
ELECTRICAL	AWL-05-CP-240	GU10 240VAC
CABLE	200mm Twin Lead	
IP RATING	IP65	
WARRANTY	Aqualux 2-Year Limited Warranty	
ADDITIONAL		

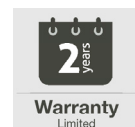
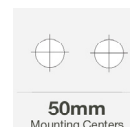



AWL-06-CP Fixed Copper Wall Light



	AWL-06-CP	
PRODUCT CODES	AWL-06-CP-240	
PRODUCT FAMILY	Elements	
MOUNTING	Surface / Wall Mount Fixed	
CONSTRUCTION	AWL-06-CP	Pure Copper
	AWL-06-CP-240	Pure Copper
ELECTRICAL	AWL-06-CP	GU5.3 SELV
	AWL-06-CP-240	GU10 240VAC
CABLE	200mm Twin Lead	
IP RATING	IP65	
WARRANTY	Aqualux 2-Year Limited Warranty	
ADDITIONAL		

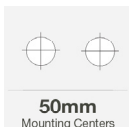
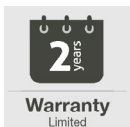
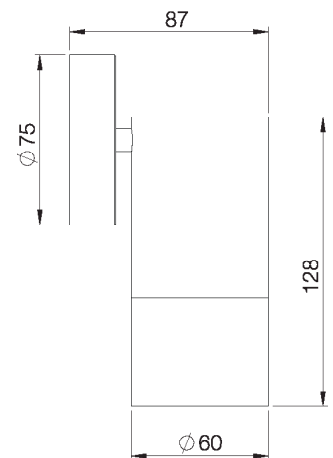

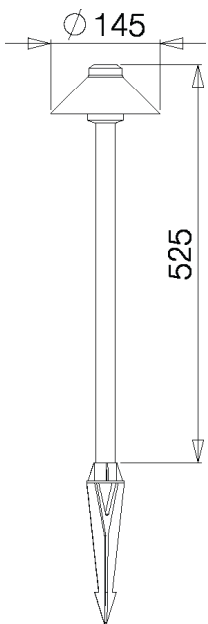

PRODUCT CODES	ABL-01-CP-LED	
PRODUCT FAMILY	Elements	
MOUNTING	Spiked Bollard	
CONSTRUCTION	ABL-01-CP-LED	Pure Copper
ELECTRICAL	ABL-01-CP-LED	12 - 24V AC / DC
CABLE	200mm Twin Lead	
IP RATING	IP65	
WARRANTY	Aqualux 2-Year Limited Warranty	
ADDITIONAL	Integrated CREE LED 3000K	

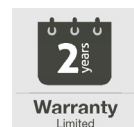

Australia's leading outdoor IP67 power supply for over 10 years, the Aqualtran AQO is known as the ultimate in durability and long-lasting performance.

- Contemporary design and housing
- IP67 Rated for full protection in outdoor use
- Resettable thermal cutout
- High Quality Toroid
- Cable exit shrouds accommodate conduit connection
- Rugged Polycarbonate Enclosure
- Thermal and UV stable epoxy resin encapsulate
- Approved to AS/NZS/EN 61558.2.6
- 1.8M Flex Lead & Plug
- 0.8M 8mm² Low Voltage Lead

Models

12V AC	VA	24V AC	VA
AQO12-020	20		
AQO12-050	50	AQO24-050	50
AQO12-100	100	AQO24-100	100
AQO12-150	150		
AQO12-200	200	AQO24-200	200
AQO12-300	300	AQO24-300	300
AQO12-400	400	AQO24-400	400

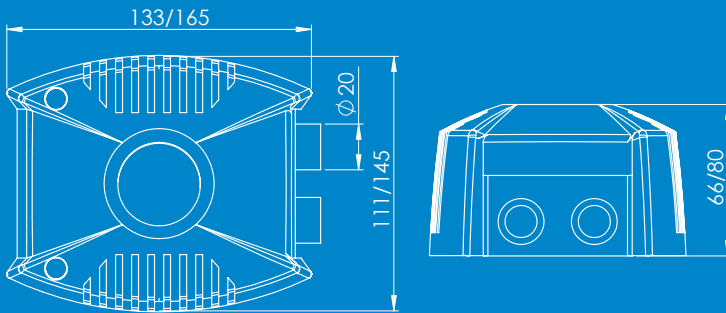

AQS-260 LED Strip

AQS-260 LED Strip is designed for 24V AC or DC applications including both outdoor and indoor installations.

AC-Compatible

Compatible with our AQO range of toroidal 24V SELV Power Supplies, AQS-260 strip will run off the same AC-trunk cable as other SELV luminaires in the Aqualux range - greatly simplifying cabling and installation issues. With no dedicated DC driver required, system and installation costs are also reduced.

IPX6 Rated

Coated in a Parylene-C CVD process, AQS-260 is IPX6 rated, providing protection in most damp and exposed locations. Should mechanical protection be required, we recommend installation into one of our aluminium profiles.

Dimming

Dimmable via a standard Universal Dimmer in conjunction with our AQO24 range of power supplies, smooth dimming from 0% - 90% is available with unprecedented ease of installation - no more 1-10V/PWM/Resistance confusion.

Technical

Product Codes	AQS-260-24-2700	2700 K
	AQS-260-24-5500	5500 K
Input Voltage	24V AC	24V DC
Watts / M	11.6	14.8
Lumens / M	690	1085
Lumens / W	59.5	73.3
IP Rating	IPX6	
Protective Coating	Parylene-C	
Max. Run Length	10M	7M
Cut Interval	100mm	
Power Supply	24V AC Magnetic	24V DC
Dimming Support	Universal 32E450UDM	



1. Exposure to direct sunlight (i.e. intense UV) should be avoided.
2. Performance will vary based on dimmer/transformer compatibility. For best results, we recommend Clipsal 32E450UDM
3. Due to the Parylene coating process, solder points should be lightly abraded/scraped to remove coating before attempting to solder. Re-coat using silicone based conformal spray.

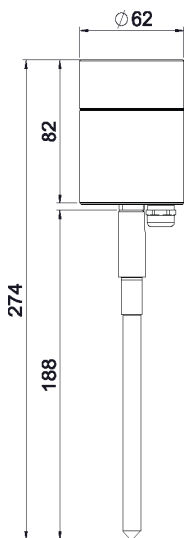

PRODUCT CODES	AUL-02-CP	
PRODUCT FAMILY	Elements	
MOUNTING	Spike Spot	
CONSTRUCTION	AUL-02-CP	Pure Copper
ELECTRICAL	AUL-02-CP	GU5.3 SELV
CABLE	200mm Twin Lead	
IP RATING	IP65	
WARRANTY	Aqualux 2-Year Limited Warranty	
ADDITIONAL		

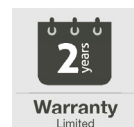



ABL-01-BR-LED Pathlight



PRODUCT CODES	ABL-01-BR-LED	
PRODUCT FAMILY	Elements	
MOUNTING	Spiked Bollard	
CONSTRUCTION	ABL-01-BR-LED	Aged Brass
ELECTRICAL	ABL-01-BR-LED	12 - 24V AC / DC
CABLE	200mm Twin Lead	
IP RATING	IP65	
WARRANTY	Aqualux 2-Year Limited Warranty	
ADDITIONAL	Integrated CREE LED 3000K Surface Mount Available	

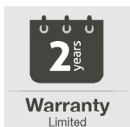
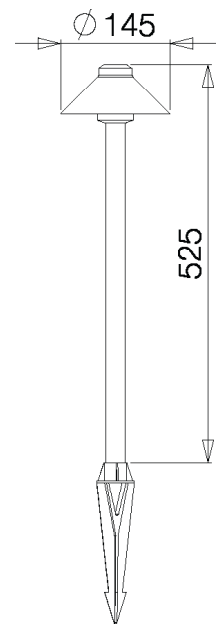

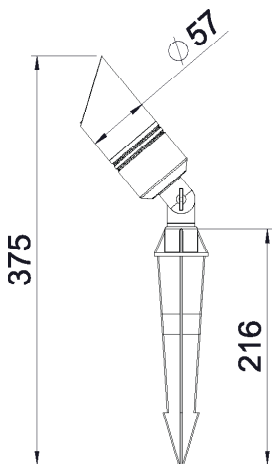

PRODUCT CODES	ASL-01-BR	
PRODUCT FAMILY	Elements	
MOUNTING	Spike Spot	
CONSTRUCTION	ASL-01-BR	Aged Brass
ELECTRICAL	ASL-01-BR	GU5.3 SELV
CABLE	200mm Twin Lead	
IP RATING	IP65	
WARRANTY	Aqualux 2-Year Limited Warranty	
ADDITIONAL	Surface Mount Plates Available 38cm & 60cm Extensions	

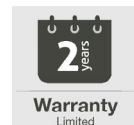

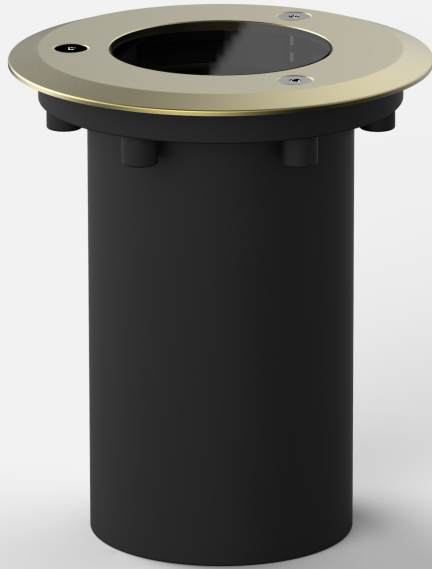

PRODUCT CODES	AUL-03-BR	
PRODUCT FAMILY	Elements	
MOUNTING	Recessed Uplight	
CONSTRUCTION	Canister	Stainless Steel 304
	AUL-03-BR	Brass
ELECTRICAL	AUL-03-BR	GU5.3 SELV
CABLE	200mm Twin Lead	
IP RATING	IP65	
WARRANTY	Aqualux 2-Year Limited Warranty	
ADDITIONAL		

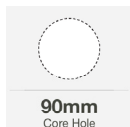
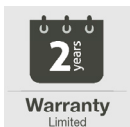
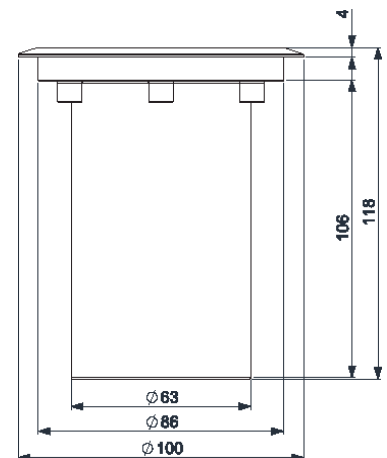

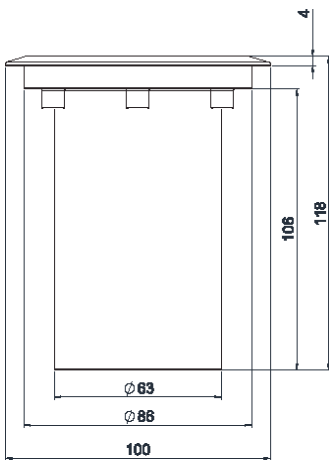
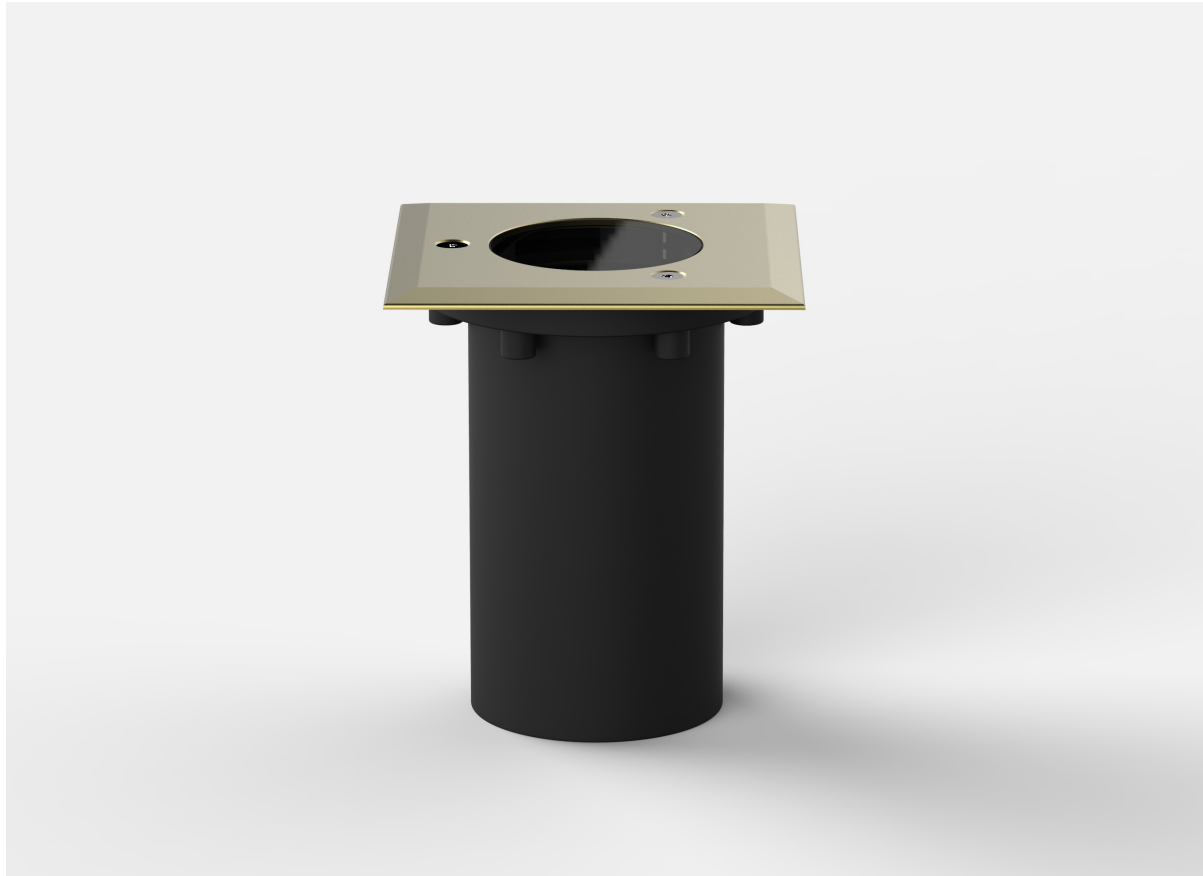

PRODUCT CODES	AUL-04-BR	
PRODUCT FAMILY	Elements	
MOUNTING	Square Recessed Uplight	
CONSTRUCTION	Canister	Stainless Steel 304
	AUL-04-BR	Brass
ELECTRICAL	AUL-04-BR	GU5.3 SELV
CABLE	200mm Twin Lead	
IP RATING	IP65	
WARRANTY	Aqualux 2-Year Limited Warranty	
ADDITIONAL		

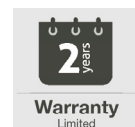
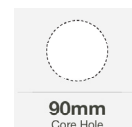

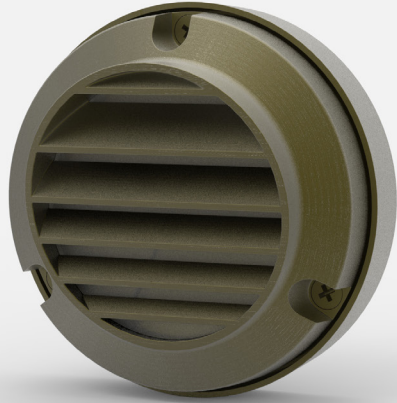

PRODUCT CODES	AWL-02-BR	
PRODUCT FAMILY	Elements	
MOUNTING	Slotted Brass Steplight	
CONSTRUCTION	AWL-02-BR	Aged Brass
ELECTRICAL	AWL-02-BR	G4 JC-Type SELV
CABLE	200mm Twin Lead	
IP RATING	IP65	
WARRANTY	Aqualux 2-Year Limited Warranty	
ADDITIONAL	12~24V CREE LED Option	

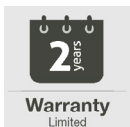
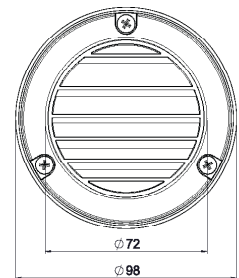



PRODUCT CODES	AWL-01-BR	
PRODUCT FAMILY	Elements	
MOUNTING	Slotted Brass Steplight	
CONSTRUCTION	AWL-01-BR	Aged Brass
ELECTRICAL	AWL-01-BR	G4 JC-Type SELV
CABLE	200mm Twin Lead	
IP RATING	IP65	
WARRANTY	Aqualux 2-Year Limited Warranty	
ADDITIONAL	12~24V CREE LED Option	

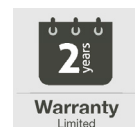
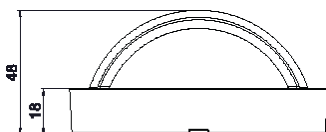
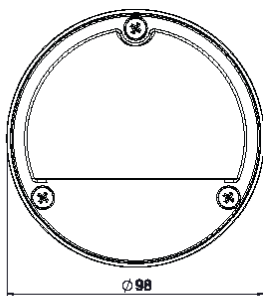

Elements

Essential Outdoor Lighting

LED Globes for Landscape Lighting

The best choice for LED MR16 Replacement outdoor luminaires.

True MR16 GX5.3 Form → Fits all MR16 / GX5.3 Luminaires.

4W Mid-Power LED Technology → Thermally optimised for enclosed fittings.

3000K / 5000K / Amber-Yellow 592nm → Lighting design flexibility.

12 ~ 24V AC/DC MultiVoltage™ Compatible → Voltage drop compensating.

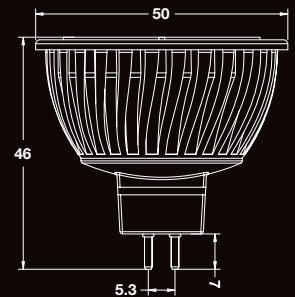

	Warm White	Warm White GU10	Cool White
POWER	4W	4W	4W
OUTPUT	250lms	250lms	260lms
EFFICACY	62.5lm / W	62.5lm / W	65lm / W
CCT	3000K	3000K	5000K
CRI	83 (Ra)	83 (Ra)	83 (Ra)
LED	SSC 3030	SSC 3030	SSC 3030
BEAM ANGLE	35 Degrees	35 Degrees	35 Degrees
LIFETIME	30,000 Hours	30,000 Hours	30,000 Hours
VOLTAGE	12V ~ 24V AC / DC	240 VAC	12V ~ 24V AC / DC
BASE	GX5.3	GU 10	GX5.3
DIMENSIONS	50mm D x 46mm H	50mm D x 60mm H	50mm D x 46mm H
PART CODE	AGL-MR16-LED-4W-WW	AGL-GU10-LED-4W-WW	AGL-MR16-LED-4W-CW



Aqualux Lighting

1300-662-644 / +61294547900 / sales@aqualux.com.au / www.aqualux.com.au
 Unit 4 / 12A Rodborough Road, Frenchs Forest, NSW, 2086, Australia
 PO Box 6059, Frenchs Forest, NSW, 2086, Australia

Copyright 2014 Aqualux Lighting. All rights reserved.

Aqualux is engaged in continual product refinement and improvement. Details contained in this document are subject to change.