

Prime Aluminium

Recessed Fixed Deep LED Downlight

Name	Prime
Material	Aluminium
Colour	Antique Brass, Black, Brass, Copper, Nickel & White
Cut Out	Ø90mm
IP Rating	IP54 (Front of fitting only)
Colour Temp	<div style="display: flex; flex-direction: column; gap: 5px;"> <div>■ 3000k</div> <div>■ 4000k</div> <div>■ 5500k</div> </div>
IK Rating	IK06
Installation Type	Ceiling - Recessed
Diffuser Type	Clear Glass
Tilt	No
Lamp Base	Built in LED
Max Wattage	12w
Protection Class	2 (No Earth Required)
Lamp Expectancy	<50,000hrs*
IC Rated	IC-4
CRI	CRI>90
SDCM	<4
UGR	<19
Flex & Plug	Yes - Included
Dimmable	Yes - Triac Dimmable
Warranty	3 Years Replacement*



Antique Brass



Black



Brass Coloured



Copper Coloured



Nickel Coloured



White

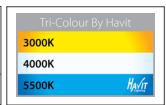
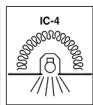
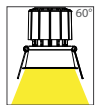

Warranty
Terms & Conditions

Website



Havit Lighting 143 Beauchamp Road, Matraville, N.S.W. 2036 | Phone: 02 9381 8300 | Fax: 02 9381 6661 | Email: sales@havit.com.au | Web: www.havit.com.au

*See Warranty Terms & Conditions for more information

Product Ordering

Image	Part Number	Colour Temp	Lumens	Input Voltage	Beam Angle	Included LED	Barcode
	HV5514T-AB	<div style="display: flex; flex-direction: column; gap: 5px;"> <div style="display: flex; align-items: center;"> 3000K</div> <div style="display: flex; align-items: center;"> 4000K</div> <div style="display: flex; align-items: center;"> 5500K</div> </div>	839lm 913lm 841lm	240v	60°	TRI Colour 12w Built in LED	9350418034403
	HV5514T-BLK						9350418010032
	HV5514T-BR						9350418034410
	HV5514T-CP						9350418034427
	HV5514T-NK						9350418034434
	HV5514T-WHT						9350418010070

Related Products



Antique Brass

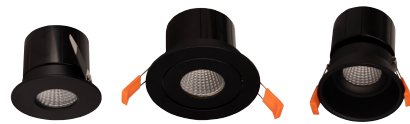

Black

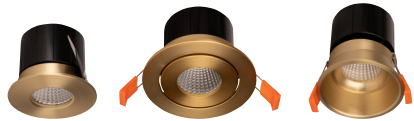

Brass Coloured

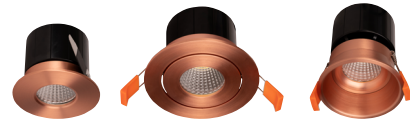

Copper Coloured



Nickel Coloured



White

Dimensions

Cut out ~ Ø90mm

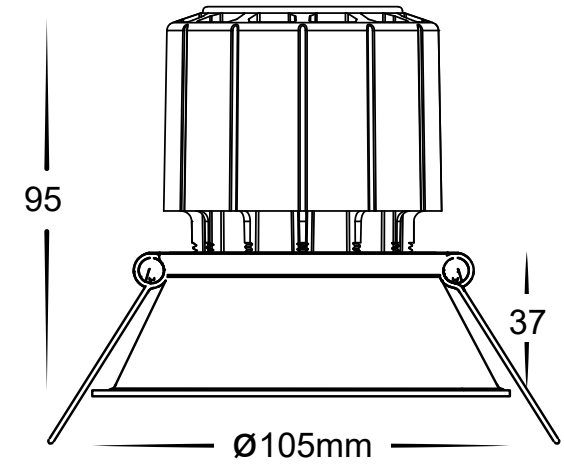

Installation Diagram

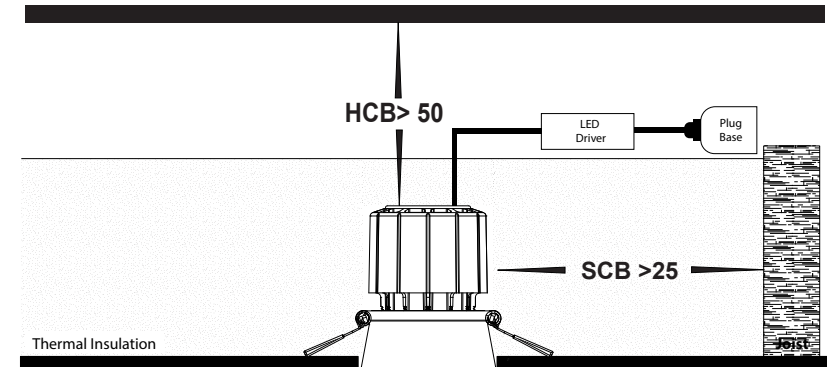

Image	Part Number	Description
Triac Dimmer		
	HV9625	Triac Dimmer to suit Triac Dimmable Drivers



Havit Lighting 143 Beauchamp Road, Matraville, N.S.W. 2036 | Phone: 02 9381 8300 | Fax: 02 9381 6661 | Email: sales@havit.com.au | Web: www.havit.com.au

*See Warranty Terms & Conditions for more information