

EVCHAM15

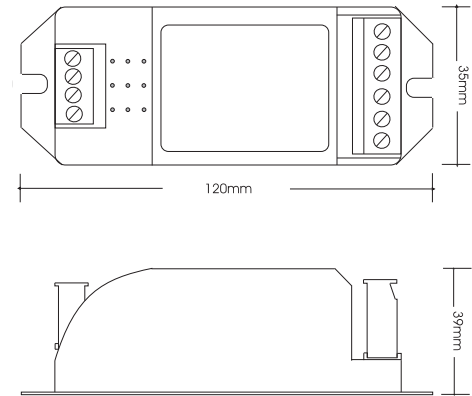

Order Code: **20124**

Product Code: **EVCHAM15 - Constant Current 350mA**

Description: Constant Current 350mA data repeater designed to suit our EVCHAM12 Wall controller.

Data: The EVCHAM15 is an intelligent data repeater specially designed for Constant Current 350mA applications. The data repeater has three channels which are capable of loads up to 16.8W per channel. Constant Voltage input Voltage for 12V to 48V DC.

Specification: 12 to 48V DC input 350mA Constant Current output x 3 channels, 1 – 12pcs 1W LEDs per channel.

Size: (L) 120mm x (W) 35mm x (H) 39mm

Requires: Constant Voltage 12-24V DC LED driver located in the power supply section of the catalogue.

12-24V DC
input

1-12 LEDs per
channel

350mA data
repeater

Constant Current
output