

EV350D6

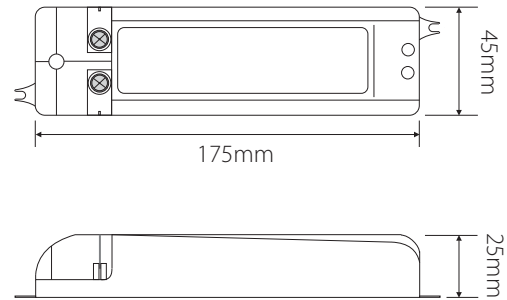

Order Code: **20390**

Product Code: **EV350D6**

Description: Constant Current mains power dimmable LED driver for use on LED Power Puk lamps, LED downlights, inground uplighters and much more.

Data: Insulation: Class II, no earth required, Supply Voltage: 190V-260V AC 50/60Hz (universal input), Supply Current: 0.35A max, Output Voltage: 21V DC SELV (Safety Extra Low Voltage), Min-Max loading: 1-6 x 1W fittings 350mA, Dimmable: Trailing edge triac Dimmers, Start delay: approx 0.5 seconds, Storage temperature: -20°C - +50°C, Ingress protection: IP20.

Features: Secondary side short circuit protection, thermal overload protection, thermal fuse to ensure safe failure if in areas of excessive temperatures, radio interference suppression in accordance with EN55015, safety and performance in accordance with EN61046, EMC immunity in accordance with EN61547, three year replacement guarantee.

Size: (L) 175mm x (W) 45mm x (H) 25mm

