

Slenda RND 250 LED Ceiling Light



Description

The SLENDА-RND series offers a sleek, ultra-thin, and unobtrusive round design, ideal for modern interiors. These surface-mounted LED ceiling lights deliver a wide 100° beam angle with uniform light distribution, powered by high-intensity Surface Mounted Diodes (SMDs). Crafted from durable polypropylene (PP) and polystyrene (PS), the SLENDА-RND is double insulated—perfect for installations without earth wiring. With an IP54 rating, it's well-suited for damp environments and coastal dwellings.

Each model features TRIO technology, allowing users to select from multiple colour temperature outputs via a convenient dip switch located on the back of the fitting. Power-selectable settings can be adjusted during installation to reduce light intensity when desired. The lights include a dimmable driver (compatible with suitable dimmers) and are flicker-free, ensuring smooth performance even during video recording.

Available in White and Black finishes, and in three sizes—250mm, 300mm, and 400mm—the SLENDА-RND range is backed by a Three-Year Commercial Replacement Warranty and a Five-Year Residential Warranty (refer to the Warranty Statement for details).

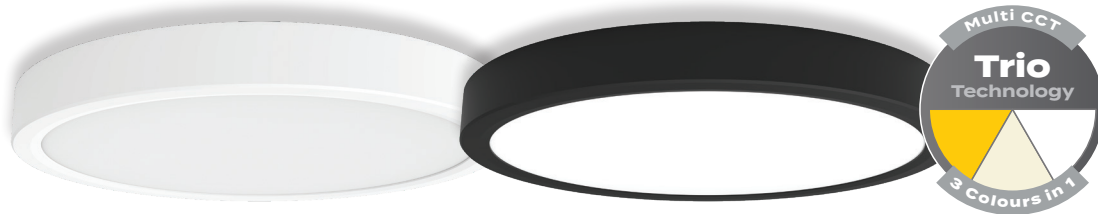

Specification Features

Input Voltage: 240V AC
Power (W): 8W/13W (Switchable)
IP rating (IP): IP54

Lumens (lm):	8W		13W	
	White	Black	White	Black
Warm White	3000K - 924lm	3000K - 901lm	3000K - 1410lm	3000K - 1348lm
Neutral White	4000K - 960lm	4000K - 933lm	4000K - 1504lm	4000K - 1473lm
White	5000K - 933lm	5000K - 909lm	5000K - 1435lm	5000K - 1410lm

LED type: SMD
CCT: 3000K - 4000K - 5000K (Switchable)
CRI: ≥80
Beam angle (°): 100°
Dimmable: Yes**
Lifespan (hrs): 50,000hrs
Warranty: 5 Year Residential*
3 Year Commercial*

* See Warranty Statement for further details.

** Fully dimmable with suitable dimmers.

Diagrams / Additional

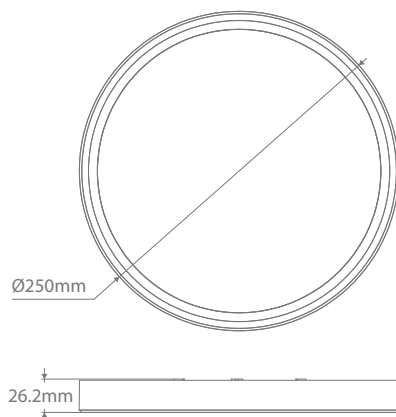

Item No.	Variant		CCT
	Wht	Blk	
SLENDА-RND-250	23300	23301	TRIO