

## Blaze-Pro-Marine-50 Floodlight F&P



### Description

The BLAZE-PRO Series LED Floodlights combine a sleek, modern look with advanced features designed for tough outdoor conditions. The marine-grade model is salt water resistant, making it ideal for coastal areas and harsh environments. These floodlights feature an aluminium fascia with frosted glass to reduce glare, an IP66 rating for excellent weather protection, and a unique anti-condensation valve to prevent moisture build-up behind the lens. The built-in multi-wattage selector and tri-colour switch make it easy to customise the brightness and colour temperature (3000K, 4000K, or 5500K) to suit any application. Every model includes a Sensor Adaptor Interface for optional plug-and-play accessories, such as the PIR sensor (BLAZE-PRO-PIR) for motion activation and the PE cell for automatic dusk-to-dawn operation. Installation is quick and easy with the 1.5m flex and plug, along with the adjustable mounting bracket. Ideal for outdoor entertaining areas, BBQ spaces, backyard lighting, and even coastal or salt water environments. Available in Black or White and backed by a 3-Year Replacement Warranty.

### Specification Features

Input Voltage:	240V
Power:	20W/30W/50W
IP rating:	IP66
Lumens:	Warm White 3000K - 2250lm, 3230lm, 5060lm Neutral White 4000K - 2360lm, 3230lm, 5060lm White 5500K - 2380lm, 3430lm, 5360lm
LED type:	SMD
CCT:	3000K - 4000K - 5500K
Luminous Efficacy:	110lm/W
CRI:	≥70
Beam angle:	120°
Dimmable:	No
Lifespan:	20,000 hrs
Driver:	DOB (driver on board)
Surge Protection:	4.5KV
Sensor:	Built-in Sensor Adaptor Interface
Cable:	1.5M flex and plug Frosted Glass Anti-Condensation Breathing Valve
Housing:	Oxidation + C5 Marine Grade outdoor powder coating
Bracket:	304 stainless steel + passivation + oxidation + C5 Marine Grade outdoor powder coating
Bracket screws:	316 stainless steel
Waterproof connector:	304 stainless steel



PECELL Remote Control PIR Remote Control

### Diagrams / Additional

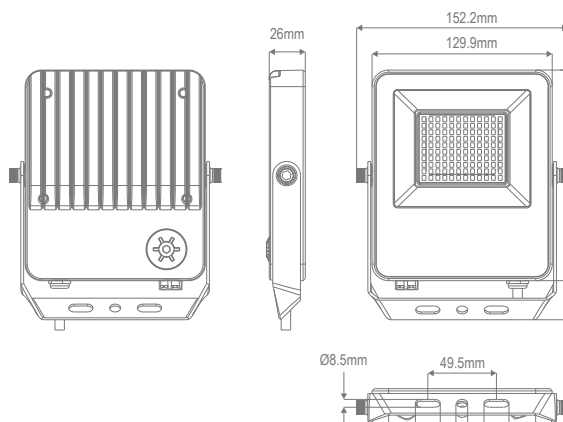

Item No.	Variant		CCT
	Blk	Wht	
BLAZE-PRO-MARINE-50	19931	19932	TRIO
BLAZE-PRO-PIR	19926	19927	N/A
BLAZE-PRO-PECELL	19928	19929	N/A
BLAZE-PRO-BKT	19923	N/A	N/A

### PECELL Sensor Features (see Sensor Data Sheet)

Voltage and current:	5V DC, 10mA
Lux Level:	10Lux/20Lux/50Lux/100Lux
IP Rating:	IP65
Operating Temperature:	-30°C - 40°C
Installation height:	≤8M
Remote Control Distance:	0-8M

### PIR Sensor Features (see Sensor Data Sheet)

Left/Right Adjustment:	90°
Up/Down Adjustment:	180°
Sensor Control:	ON/OFF
Time Delay Settings:	1, 3, 6 & 12Min
Sensitivity Settings:	25%, 50%, 75% & 100%
Sensitivity Distance:	2-8M
IP Rating:	IP65