

BL-6812

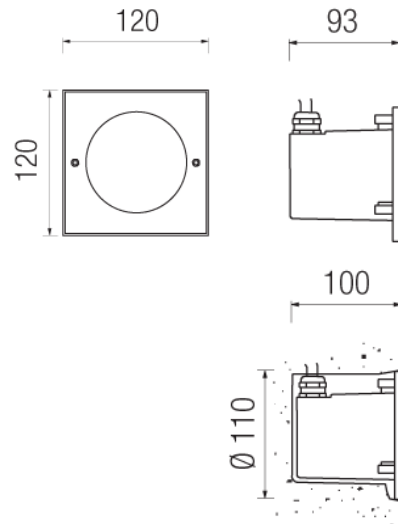

BL-6812.090

Lamp: QT9
Power: 20W
Base: G4

BL-6812.140

Lamp: QT14
Power: 25W
Base: G9

BL-6812.600

Lamp: T2
Power: 6W
Base: Gx53

BL-6812.880

Lamp: 1 x White LED
Power: 4.1W
LED: 230lm 6300K

- Indoor and outdoor recessed wall luminaire
- Painted die-cast aluminium structure
- Gold-plated brass cover
- Satin tempered glass diffuser
- Aluminium reflector
- Silicon gaskets
- Technopolymer holder
- Stainless steel screws
- Painting using high resistance to UV and corrosion polyester powders

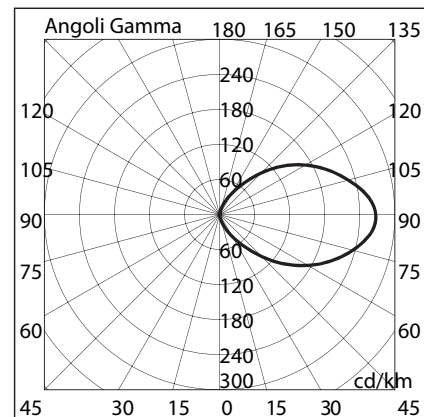

6812 14

