

BL-5093

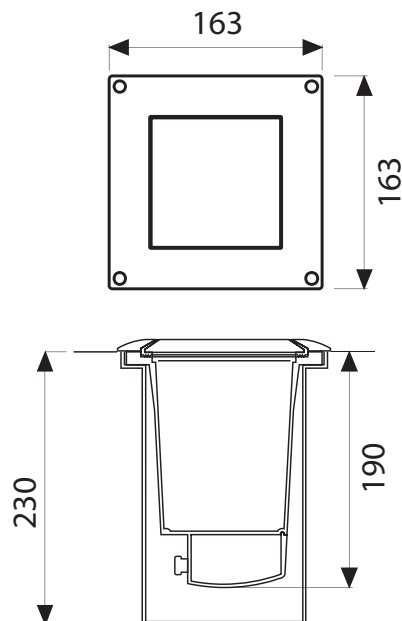
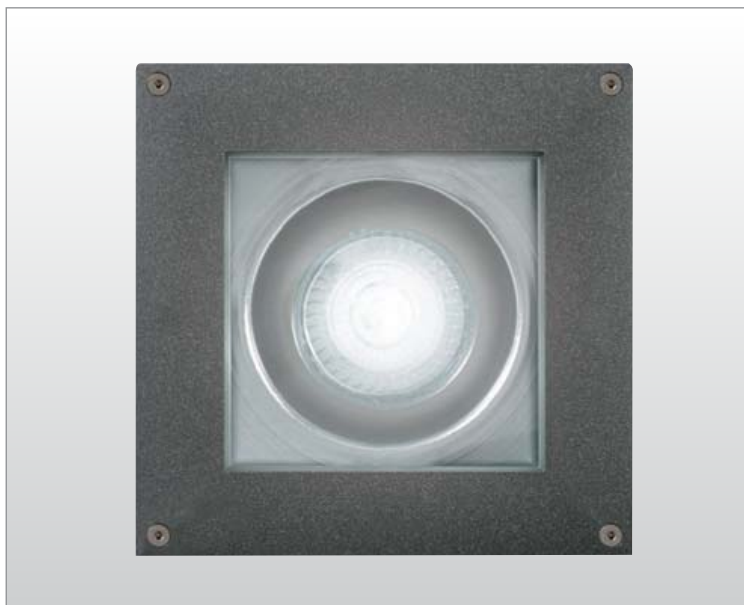

BL-5093.00X

Lamp: Q PAR20
Power: 50W
Base: E27

BL-5093.15X

Lamp: Q PAR16
Power: 40W
Base: E14



BL-5093.88X

Lamp: 1 x White LED
Power: 4.1W
LED: 230lm 6300K

BL-5093.66X

Lamp: 3 x White LED
Power: 9W
LED: 500lm 6300K

Available Colours:

X=2  White X=4  Silver
X=9  Anthracite

- Outdoor recessed ground luminaire
- Painted die-cast aluminium structure
- Die-cast aluminium cover
- Transparent glass diffuser
- Aluminium reflector
- Silicon gaskets
- Stainless steel screws
- Technopolymer holder
- Painting using high resistance to UV and corrosion polyester powders

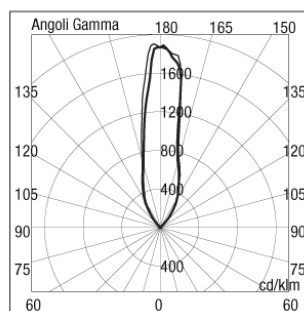

5093 00

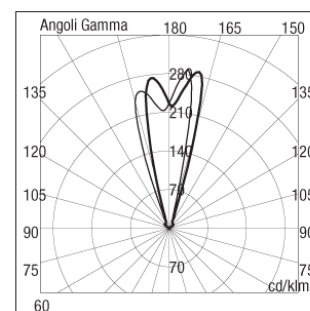

5093 66

