

BL-4011

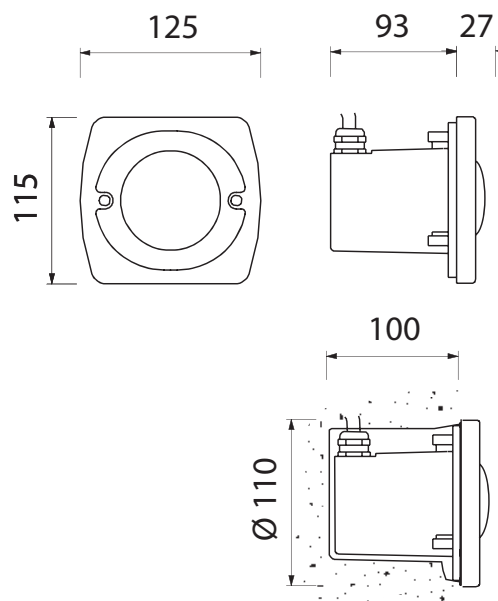

BL-4011.09X	BL-4011.14X	BL-4011.88X
Lamp: QT9	Lamp: QT14	Lamp: 1 x White LED
Power: 20W	Power: 25W	Power: 4.1W
Base: G4	Base: G9	LED: 230lm 6300K

Available Colours:

X=3		Black	X=9		Anthracite
X=4		Silver			

- Indoor and outdoor recessed wall luminaire
- Painted die-cast aluminium structure
- Tempered glass diffuser
- Aluminium reflector
- Silicon gasket
- Stainless steel screws
- Technopolymer wall holder
- Painting using high resistance to UV and corrosion polyester powders

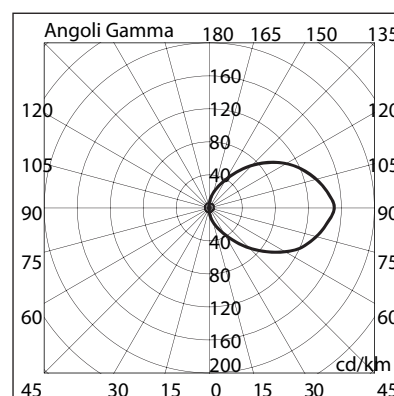

4011 14



Domus Lighting

29-31 Richland Street Kingsgrove NSW 2208

Phone: (02) 9554 9600 | Fax: (02) 9554 9433 | Email: sales@domuslighting.com