

BL-1054

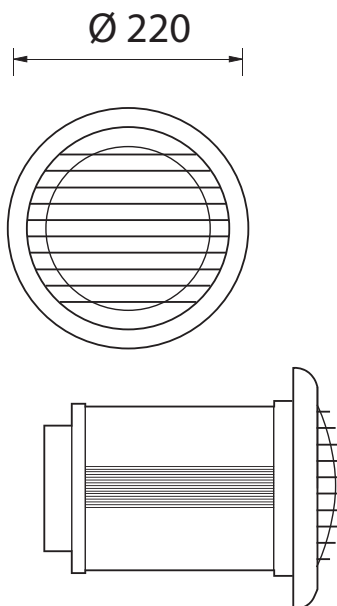

BL-1054.00X

Lamp: QPAR30

Power: 75W

Base: E27

Available Colours:

X=2 White X=9 Anthracite

X=3 Black

- Ground luminaire
- Die-cast aluminium structure
- Transparent tempered glass diffuser
- Aluminium reflector
- Silicon gaskets
- Stainless steel screws
- Polypropylene holder
- Painting using high resistance to UV and corrosion polyester powders



Domus Lighting

29-31 Richland Street Kingsgrove NSW 2208

Phone: (02) 9554 9600 | Fax: (02) 9554 9433 | Email: sales@domuslighting.com