

Surface Mount Downlight

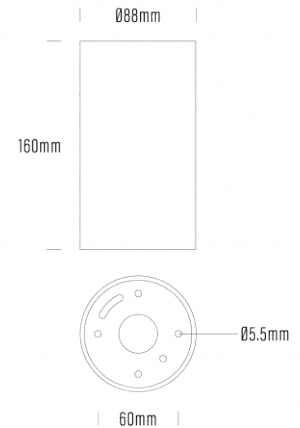

SPECIFICATIONS

Product Code	AQL-880
Family	LumenaPro
Construction Material	CNC Machined Aluminium
Cable	Terminal Block
IP Rating	IP65
Warranty	7 Year Aqualux Warranty

CONFIGURED OPTIONS

Variant Code	AQL-880-A3B02027U4T
Body Colour	Medium Bronze
Control Gear	24V DC
Rated Power	20W
Nominal Lumens	2500 lm
CCT / Colour	2700K / 500mA
Optical	U4
CRI	90
Other	Terminal Block
Dimming	3-wire PWM 10V Dimming

INTRODUCTION

The AQL-880 is an advanced, highly configurable surface mount down light for use in architectural and commercial applications.

Featuring integrated DALI, 24V SELV or Remote control gear options along with choices of Ultra Low Glare or High Efficiency reflector optics, the AQL-880 is also available in any Dulux powder coat finish for the ultimate in project specification flexibility. RGBW and speciality sources such as 98CRI and 2200K are also available.

The AQL-880 is 100% designed and manufactured in Sydney, Australia.



1300 662 644
sales@aqualux.com.au