

Uplight

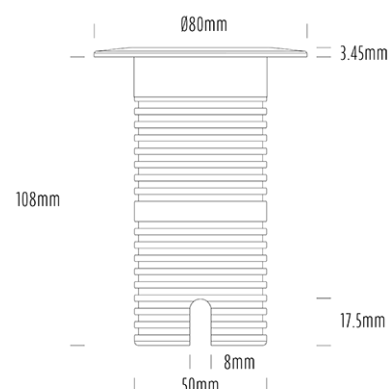

SPECIFICATIONS

Product Code	AQL-530
Family	Phoenix
Construction Material	Solid Cast Brass
Cable	1M Aqualux PLUS QuickConnect
IP Rating	IP68
Warranty	5 Year Aqualux Warranty

CONFIGURED OPTIONS

Variant Code	AQL-530-B3D007BU25Q
Body Colour	Aged Brass
Control Gear	24VAC Triac Dimmable
Rated Power	7W
Nominal Lumens	160 lm
CCT / Colour	Blue 470nm
Optical	25
CRI	00
Other	AqualuxPLUS QuickConnect
Dimming	Yes, TRIAC Primary Side

INTRODUCTION

Sharing many of the same components as the AQL-540, the AQL-530 is designed to withstand the worst conditions nature can offer. Solid cast brass with 4 finish options and epoxy encapsulated internals the AQL-530 is suitable for any application that requires the best in reliability and performance.



1300 662 644
sales@aqualux.com.au