

Surface Mount Spot

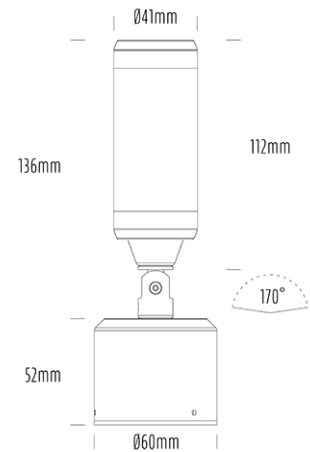

SPECIFICATIONS

Product Code	AQL-220
Family	Lumena
Construction Material	CNC Machined Aluminium
Cable	900mm Aqualux 2-Core Silicone / PTFE Cable
IP Rating	IP67
Warranty	7 Year Aqualux Warranty

INTRODUCTION

Surface mount adjustable spot.

CONFIGURED OPTIONS

Variant Code	AQL-220-A1X0043025S
Body Colour	Silver Reign
Control Gear	12~24V AC / 24V DC
Rated Power	4W
Nominal Lumens	300 lm
CCT / Colour	3000K / 300mA
Optical	25
CRI	90
Other	1m Aqualux Cable
Dimming	Optional 3-Wire 10V PWM (DC)



1300 662 644
sales@aqualux.com.au

Aqualux Warranty September 2021

AQUALUX LIMITED WARRANTY INFORMATION

Aqualux sources, designs, and manufactures advanced landscape lighting of many different varieties. We utilise the highest-grade components manufactured inhouse as well as sourced from around the globe and assembled in our quality-controlled Sydney, Australia facility.

From time to time, for a variety of possible reasons, our products may experience an issue after installation. This page details the various warranties our products carry, the causes of product failure that we have experienced over time, and the steps necessary to make a warranty claim should that be necessary.

FIT-FOR-PURPOSE & INSTALLATION REQUIREMENTS

All warranties offered in addition to the statutory requirement of 1 Year are done so on the condition that Aqualux lighting products are fit-for-purpose and installed professionally by qualified persons and that all guidelines and requirements are followed.

Fit-for-purpose in this context refers to the intended application our products are designed for which is residential and commercial garden & landscaping environments. Products not specifically designated IP68 are not fit for submersion, either intended or accidental.

REMOTE, DIFFICULT & UNUSUAL INSTALLATIONS

Where Aqualux products are installed in unusual, remote, or difficult to access locations and environments, this is done so at the end user's risk. Where warranty issues arise, Aqualux is limited in its liability to the cost of repairing or replacing the product only.

Examples of remote & unusual installations include (but are not limited to) jobs that require scissor lifts, traffic management, significant labor, or the removal of paneling or other secondary installation materials.

If you are uncertain, please contact us to discuss

1300-662-644 / sales@aqualux.com.au

AQS SERIES STRIP LIGHTING

Please pay particular attention to our fit-for-purpose and unusual installation warranty notes when designing with AQS LED Strip Lighting.

Whilst LED strip lighting allows for unique and previously impossible lighting effects to be achieved, it is still a sensitive electronic product that is potentially subject to failure through a variety of modes including (and most often) improper handling during installation.

All Aqualux AQS products are tested before they leave our factory. We strongly advise customers to test the product prior to installation. Aqualux is not liable for any costs associated with accessing or replacing the AQS-Series strip.

WARRANTY CLAIMS PROCEDURE

To make a claim for service to repair or replace a product under an Aqualux warranty, contact the original reseller and/or installer of the product.

They will generally be able to process the claim on your behalf. If your original reseller is no longer in business or you are not sure who it may have been, please contact us

directly with a photo of your product and a summary of the issue. Aqualux may elect to repair or replace your product depending on the nature of the fault and product serviceability.

CABLE TERMINATION REQUIREMENTS

Cable terminations and joins must be IP-rated for this warranty to apply. Joins and connections that are not fit-for-purpose or that are manifestly unsuitable will not be serviced by Aqualux and any product failure arising from such terminations will not be claimable under this warranty.

Please refer to the cable join / termination guide available on our website for more information.

QUICK CONNECT CABLES

Where a product has a quick connect cable, anti-siphon device, or other feature(s) it/they should never be removed. Doing so will void your warranty and in the event of product, failure makes the job of repair/replacement unnecessarily more difficult and costly. If you are concerned one of these features may impact your ability to install our products contact us prior to your order placement.

THE FINE PRINT

Aqualux Lighting is a brand wholly owned by Telectran International. Telectran International Pty. Ltd. ("Telectran") warrants to the purchaser of products described herein that they be free from defects in material and workmanship for a period commencing at the date of purchase and expiring at the end of the period specified (the "warranty period").

No other warranty, whether express or implied, including any warranty of merchantability or fitness for a particular purpose, shall exist in connection with the sale or use of such products.

Defects that are, in the sole judgment of Telectran, the result of an accident, misuse, abuse, neglect, mishandling, misapplication, faulty installation, unauthorized repair, modification, or acts of God will not be covered by this warranty.

Telectran shall not be liable for incidental or consequential damages, including but not limited to labour costs or lost profits resulting from the use of or inability to use the goods or from the goods being incorporated in or becoming a component of any other product. Without limiting the generality of the foregoing, Telectran will not be responsible for labour costs involved in the removal of goods or the installation of replacement goods.

If a problem develops with a product during the warranty period call or email us. We may be able to help you identify specific problems and possibly solve them before the unit is returned to us for repair or replacement. In any case, **DO NOT RETURN ANY GOODS WITHOUT OBTAINING A RETURN NUMBER** and instructions from us. Telectran cannot be responsible for damage due to shipping or improper packaging when returning goods. Please see our returns policy for further information.

Upon receipt of a claim, Telectran shall inspect the part or parts claimed to be defective, and we shall repair, or at our discretion, replace, free of charge, any part or parts which we determine to have been defective.

APPLICABLE WARRANTY PERIODS

If you cannot find your product below, please contact us. Warranty periods are subject to change without notice - this will not affect an existing purchase.

Product code or family	Warranty (years)	Product code or family	Warranty (years)
AQL-450, 451 & 452" Turbo"	5 years	AQL-455 "Eco"	2 years
AQL-400 to AQL-420	5 years	AQL-510, 520, 530, 540, 565 & AUL-03 AUL-04	7 years
Lumena / Lumena Pro Range	7 years	AQL-600 Range	3 years
AQL-910, 911, 912 & 913	3 years	AQL-931 & AQL-933	5 years
AQA Artisan Range	10 years	Festoon and Fairy Lights	3 years
AQS Strip Light	3 years	Aquatran AQO AC	10 years
Aquatran AQD DC	5 years	AGL Globes	3 years
Other AQD Control Gear	3 years		