

Spotlight

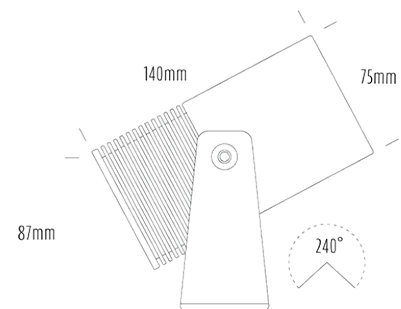

SPECIFICATIONS

Product Code	AQL-180
Family	LumenaPro
Construction Material	CNC Machined Aluminium
IP Rating	IP67
Warranty	5 Year Aqualux Warranty

CONFIGURED OPTIONS

Variant Code	AQL-180-A1Z020Z425Q
Body Colour	Satin Chrome Anodize
Control Gear	24V DC RGBW
Rated Power	20W
Nominal Lumens	1090 lm
CCT / Colour	20W RGB+6500K
Optical	25
CRI	80
Other	AqualuxPLUS QuickConnect
Dimming	4CH Low-Side PWM

INTRODUCTION

The AQL-180 is a high-output projector designed for architectural and commercial lighting applications. Available in White or RGBW options with advanced colour mixing optics, the AQL-180 is perfect for the dynamic RGB illumination of a variety of external facades and features.



1300 662 644
sales@aqualux.com.au