

Runway Light

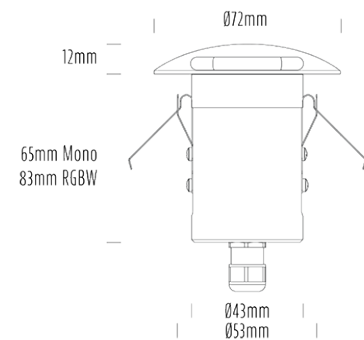

SPECIFICATIONS

Product Code	AQL-163
Family	Lumena
Construction Material	CNC Machined & Anodised Aluminium 6061
Cable	900mm Aqualux 2-Core Silicone / PTFE Cable
IP Rating	IP67
Warranty	5 Year Aqualux Warranty
Additional	RGBW option to be driven at 50% max total. Not rated for high-pressure cleaning.

INTRODUCTION

The AQL-163 is a compact, stylish recessed runway light with 90° spread.

CONFIGURED OPTIONS

Variant Code	AQL-163-A1X00130DCQ
Body Colour	Satin Chrome Anodize
Control Gear	12~24V AC / 24V DC
Rated Power	1W
Nominal Lumens	100 lm
CCT / Colour	3000K / 300mA
Optical	DC
CRI	80
Other	AqualuxPLUS QuickConnect
Dimming	Optional 10V PWM (DC)



1300 662 644
sales@aqualux.com.au