



FLARE SERIES

LED Street Flood Lights

- Input voltage: 240V AC 50-60Hz
- Wattage: 60W, 90W & 120W
- Hongli SMD3535 LED chips
- Material: die-cast aluminium body
- IP67 Sosen SAA approved driver included
- Power factor: >0.95
- Ambient temp: -20 to 45°C

50,000 HRS	BEAM 150°	IP 66	IK 08	5 YEAR WARRANTY
---------------	--------------	----------	----------	--------------------



NOTE: When vertical, the beam angle is 80°

CODE	DESCRIPTION	TECHNICAL DATA					CARTON QTY
		KELVIN (K)	LUMENS (LM)	WATT (W)	CRI	LED (pcs)	
FLARE1	60W LED STREET LIGHT 5000K	5000	6000	60	>75	48	1/1
FLARE2	90W LED STREET LIGHT 5000K	5000	9000	90	>75	72	1/1
FLARE3	120W LED STREET LIGHT 5000K	5000	12000	120	>75	96	1/1

UPDATED ON 01.12.2016



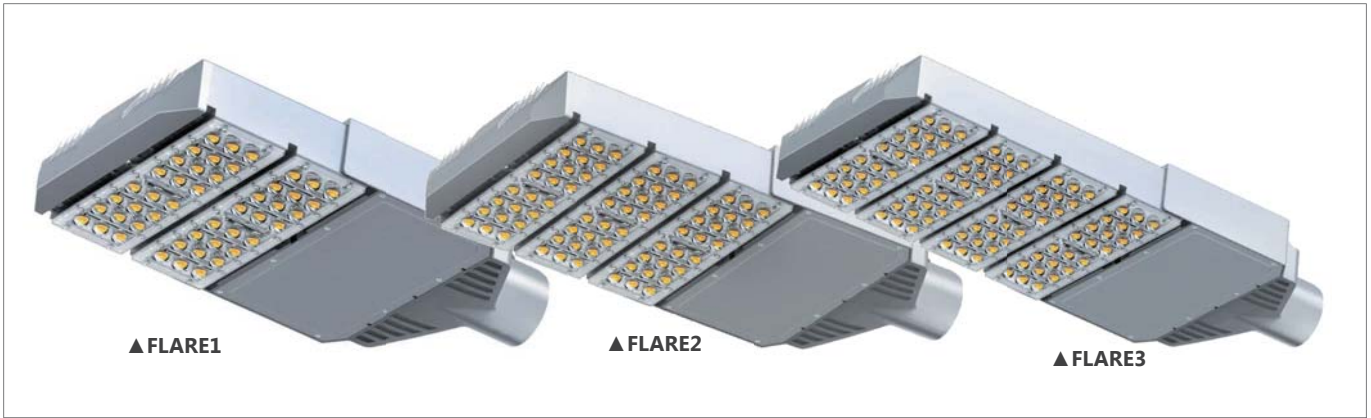

▲ FLARE1

▲ FLARE2

▲ FLARE3

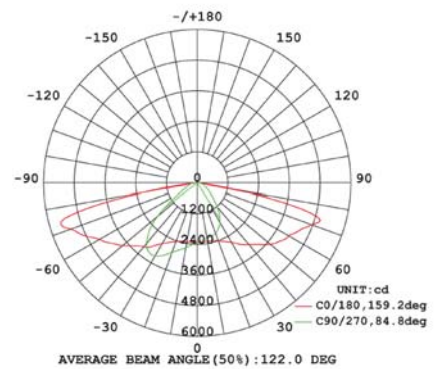
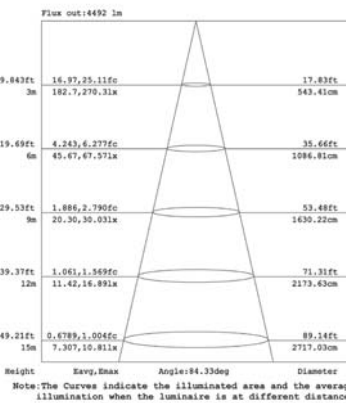
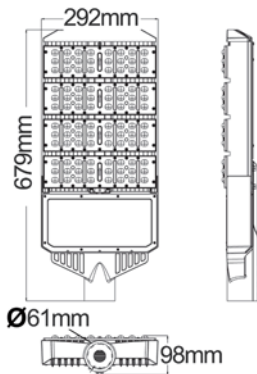
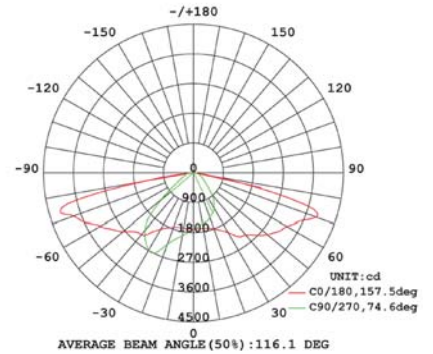
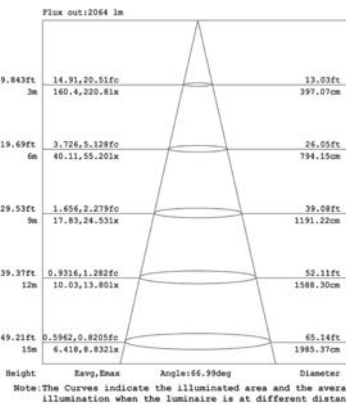
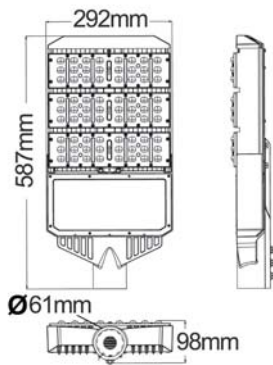
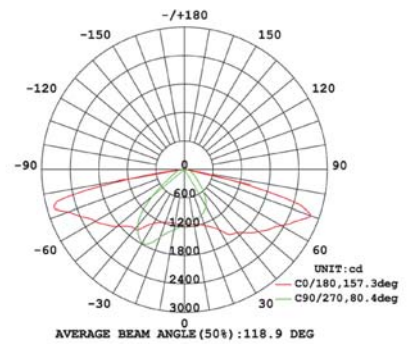
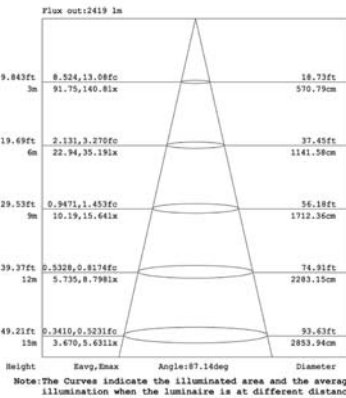
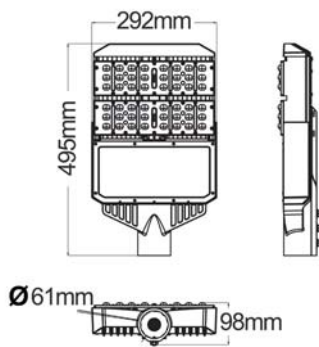

UPDATED ON 01.12.2016

Dimensions for mounting point of FLARE series			
	FLARE	FLARE2	FLARE3
OUTTER DIAMETER OF THE MOUNTING POINT	Ø77mm	Ø77mm	Ø77mm
INNER DIAMETER OF THE MOUNTING POINT	Ø61mm	Ø61mm	Ø61mm
LENGTH OF THE MOUNTING POINT	120mm	120mm	120mm
NET WEIGHT (KG)	6.5	7.4	8.5
PANTONE NO.	SILVER 877C	SILVER 877C	SILVER 877C

APPLICATIONS

- General road lighting
- Residential area, yard park, industrial area
- Petrol station, car parks

UPDATED ON 01.12.2016

