

**32W 1420MM (56") SMART DC CEILING FAN
3 TIMBER BLADES WITH WIFI REMOTE CONTROL**



Warranty



DC Motor



Wi-Fi



Indoor & Covered
Outdoor Use



Summer/
Winter
Reverse
Function

Model Numbers

MNDC143WM	Matt White/Natural
MNDC143WW	Matt White/White Wash
MNDC143MW	Matt Black/Walnut

Features

- Brushless quiet and efficient 32W DC motor
- WiFi connectivity and operate via Smart Life application
- Low profile designed ideal for indoor and covered outdoor applications
- Unique comfort sleep and breeze mode + 6 other speed settings
- Steel body, canopy and solid timber blades
- Fully reversible for summer and winter mode from remote control



Scan for
product
information

32W 1420MM (56") SMART DC CEILING FAN 3 TIMBER BLADES WITH WIFI REMOTE CONTROL

SPECIFICATIONS

Model Name	Norfolk DC
Model Numbers	MNDC143WN Matt White/Natural MNDC143WW Matt White/White Wash MNDC143MW Matt Black/Walnut
Power Wattage / Motor	32W DC
Voltage / Frequency	220-240Va.c. 50-60Hz
Air Movement (m³/hr)	
Maximum RPM	Up to 190 RPM
Airflow Efficiency	Up to 278m ³ /hr per watt
Speed 6 (Highest)	9,950m ³ /hr
Speed 5	7,850m ³ /hr
Speed 4	6,780m ³ /hr
Speed 3	5,530m ³ /hr
Speed 2	4,080m ³ /hr
Speed 1 (Lowest)	3,260m ³ /hr
Materials / Blade	Timber blade
Number of Blades	3
Blade Pitch	9°
Hangsure Canopy	15°
Lighting Wattage / Type	N/A
Colour Temperature	N/A
Lumens Output	N/A
Rated Lifetime	N/A
Dimmable	N/A

REMOTE CONTROL

Control	
Light	N/A
CCT	N/A
Fan	Off only
Fan Speed Setting	6
Other Features	Summer/winter reverse mode Breeze mode Sleep mode
Timer	Off only - 1hr, 4hr or 8hr
Power	1 x A23 12V batteries (supplied)
Size	145 x 42mm
Radio Frequency	433Mhz

SHIPPING

Model Numbers	Carton Size			Carton Quantity	Carton Gross Weight (Kg)
	H (mm)	W (mm)	L (mm)		
MNDC123WN	225	320	750	1	5.1
MNDC123WW	225	320	750	1	5.1
MNDC123MW	225	320	750	1	5.1

INSTALLATION

Installation	By licensed electrician only
Warranty	6* year warranty (*3 year in-home + additional 3 year replacement on the motor only)

DIMENSIONS

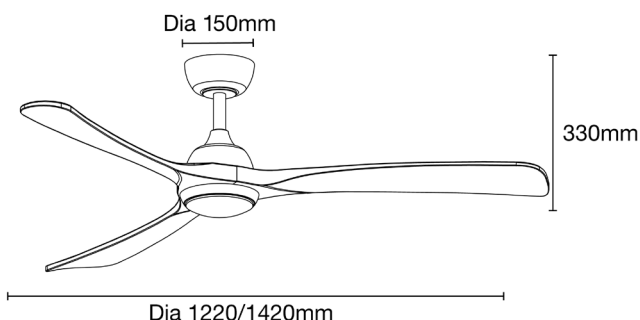

* Product must be installed by licensed electrician if not warranty will be void. Visit website for further information regarding warranty terms and conditions. Specification and imagery subject to change without prior notice. Last updated October 2023.



Aust/NZ Approval No.
GMA-517332-EA