

# Sign Lite

Cat. No. SGNL

Cat. No. SGNLGU

Cat. No. SGNLMH20

Cat. No. SGNLMH35



The Sign Lite is for lighting signs, wall displays, building highlights, and external barbeques. The fully adjustable head is mounted on the end of a 500mm (19.5") arm, allowing 360 degree rotation and 90 degree elevation.

Available in 12 volt or with a built in 110 or 240 volt transformer (Retro™) option. This luminaire is machined from a choice of 10mm solid aluminium with a UV stable powder coated finish, solid copper or 316 stainless steel with a clear, tempered, flush glass lens and high temperature silicon gaskets.

A GU10 version of this luminaire is also available for line voltage lamps. However, a longer luminaire body is needed to accommodate the longer lamp. The Sign Lite Metal Halide is extremely energy efficient, outputting 2-3 times the light of a halogen lamp, and uses a GX10 20 or 35 watt lamp.

## Ordering Information

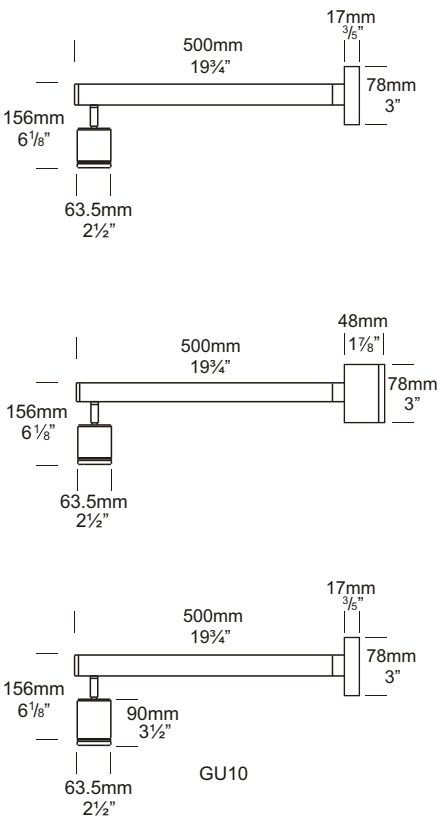

### Luminaire Type

SGNL - Sign Lite

### Material/Finish

BK - Black  
 BZ - Bronze  
 GN - Green  
 STAR - Silver Star  
 WH - White  
 WB - Birch  
 DG - Dark Grey  
 OG - Olive Green  
 RG - Beige  
 PR - Primrose  
 COP - Copper  
 SS - 316 Stainless Steel

### Accessories

CJK150 - Cable Joint Kit  
 LENSSTEPF - Frost Lens  
 GG - Glare Guard  
 (Not for Metal Halide)  
 HCL - Hex Cell Louvre Adaptor  
 /R - Retro™ Transformer  
 110/240-12 volt  
 GU - GU10 Option  
 MH - Metal Halide Option  
 For **LED** options, refer to page 10.4 (dedicated LED), 10.4.3 (6 watt), 10.4.4 (3 watt) or <http://hunza.co.nz/l.html>

Ordering Example: SGNL SS - Sign Lite 316 Stainless Steel  
 SGNLGU COP - Sign Lite GU10 in Copper  
 SGNLMH20 BK - Sign Lite Metal Halide 20 watt in Black  
 HCL - Hex Cell Louvre Adaptor  
 (Accessories ordered separately)

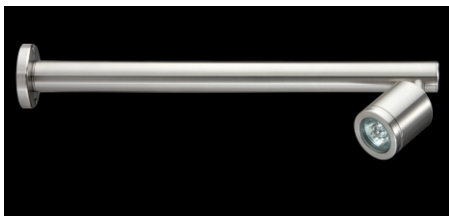

**HUNZA**™ PURE OUTDOOR LIGHTING

**HUNZA FACTORY**  
 130 Felton Mathew Ave  
 Glen Innes  
 Auckland 1072  
 New Zealand

Ph: 64-9-528 9471  
 Fax: 64-9-528 9361  
[hunza@hunza.co.nz](mailto:hunza@hunza.co.nz)  
[www.hunza.co.nz](http://www.hunza.co.nz)

**INTERNATIONAL CONTACTS:**  
[www.hunza.co.nz/contacts.php](http://www.hunza.co.nz/contacts.php)

Specifications may change without notice.  
 Manufactured in New Zealand.  
 © 2011 Hunza Holdings Ltd.

Ver 1.4

## Luminaire Construction

CNC machined from one of the following metals:

High corrosion resistant 63.5mm (2½") x 10mm (25/64") aluminium. End cap - solid aluminium 63.5mm (2½") rod, with chromate substrate and high UV resistant polyester powder coat - Colours Black, Bronze, Green, Silver Star, White, Birch, Dark Green, Olive Green, Beige, Primrose.

**Copper** 63.5mm (2½") x 10mm (13/32"). End cap - solid copper 63.5mm (2½") rod.

**316 Stainless Steel** 63.5mm (2½") x 9mm (11/32"). End cap - solid 316 stainless steel 63.5mm (2½") rod.

**Poles** Aluminium, Copper, 316 Stainless 38mm (1½") x 500mm (19¾") tube.

## Mounting

12 volt: the luminaire is mounted to the wall using two 316 stainless screws through a shallow base 16mm (5/8") in depth. A Wall Box Adaptor Plate is available as an accessory to fit 3.0 and 4.0 junction boxes for USA/Canada.

Retro™ 110/240-12 volt: a mounting plate is fixed to the wall using two screws, the luminaire is fitted to the mounting plate.

## Features

**Lens:**  
10mm (3/8") clear flush fit shatter resistant glass. Lifetime Warranty.

**Gaskets:**  
Silicone, iron impregnated 220°C (428°F).

**Lamp Holder:**  
GU5.3 & GU10 - 350°C (662°F) ceramic multi contact lamp holder with 250°C (480°F) teflon cables.

**Metal Halide GX10 - 350°C (662°F)** ceramic multi contact lamp holder with 250°C (480°F) teflon cables.

**Accessories:**  
Cable Joint Kit (Cat. CJK150).  
Not approved for USA /Canada.  
Frosted Lens (Cat. LENSSTEPF).  
Glare Guard (Cat. GG).  
Hex Cell Louvre Adaptor (Cat. HCL).  
Retro™ transformer 110/240-12 volt (Cat. /R) IP66.  
GU10 Option (Cat. GU).  
Metal Halide Option (Cat. MH).

**Swivel:**  
**Aluminium and Copper** luminaires 360° rotation and 0 - 90° elevation, solid brass with anti rust spring.

**Stainless Steel** luminaires 360° rotation and 0 - 90° elevation, full stainless steel construction.

## Standards

IP56/IP66  UL1838

### Luminaire Weight

12 volt: Alum 1kg (2lb 2oz)  
Cop 2.140kg (4lb 11oz)  
SS 1.620kg (3lb 9oz)  
Retro™: Alum 1.5kg (3lb 3oz)  
Cop 3.200kg (7lb)  
SS 3.055kg (6lb 11oz)

### Power Supply

HUNZA™ Inground or Wall Mount Transformer: not included.  
Metal Halide - 230-240 volt ac 50Hz built in ballast

### RETRO™

HUNZA™ 110/240-12 volt ac potted electronic transformer is built into the base.

Dimmable with a suitable dimmer.  
\* Note see page 9.4 for details.

USA and Canada:

HUNZA™ Wall Mount Transformer: not included.

Metal Halide - 120 volt ac 60Hz built in ballast

**Luminaire: supplied with**

MR16 GU5.3 20, 35 watt lamp max.  
GU10 - GU10 25 or 35 watt lamp max.

**LED** - Refer to previous page.

Metal Halide - GX10 20 or 35 watt lamp  
USA and Canada:

MR16 GU5.3 20, 35 watt lamp max.  
GU10 Halogen - Lamp not supplied

**LED** - Refer to previous page.

Metal Halide - GX10 20 or 35 watt lamp

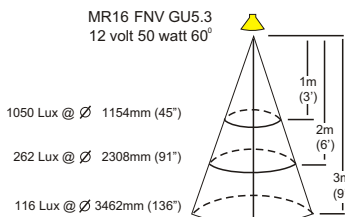
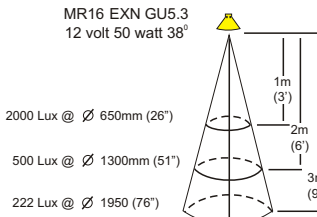
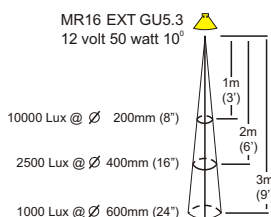
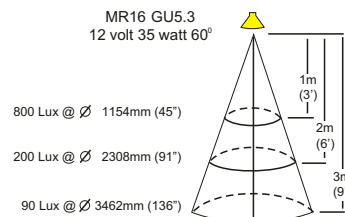
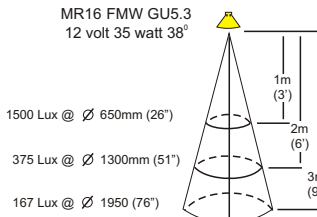
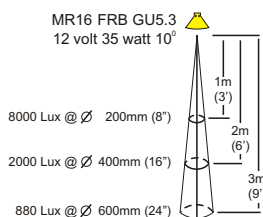
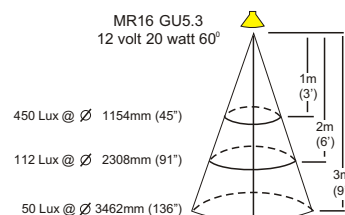
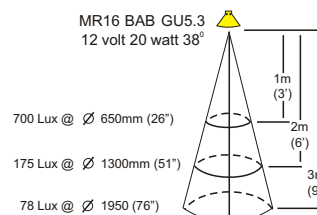
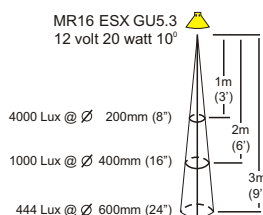

**HUNZA™** PURE OUTDOOR LIGHTING

**HUNZA FACTORY**  
130 Felton Mathew Ave  
Glen Innes  
Auckland 1072  
New Zealand

**Ph: 64-9-528 9471**  
**Fax: 64-9-528 9361**  
hunza@hunza.co.nz  
www.hunza.co.nz

**INTERNATIONAL CONTACTS:**  
www.hunza.co.nz/contacts.php

Specifications may change without notice.  
Manufactured in New Zealand.  
© 2011 Hunza Holdings Ltd.

Ver 1.4