

4.8w 24v DC IP20 10M Viper Kits



PRODUCT SPECIFICATIONS

Name	Viper
Wattage Per Metre	4.8w
Colour Temp.	3000K, 4000K, 5500K
CRI:	>80
Beam Angle	120°
IP Rating	IP20
Size	8mm x 2mm
Dimmable	No
LED Chip Type	2835
LED Chips Per Metre	60
Supplied Length	10m
Cutting Increments	Every 100mm
Wiring	Parallel
Dimmable	No
Warranty	2 Years Replacement

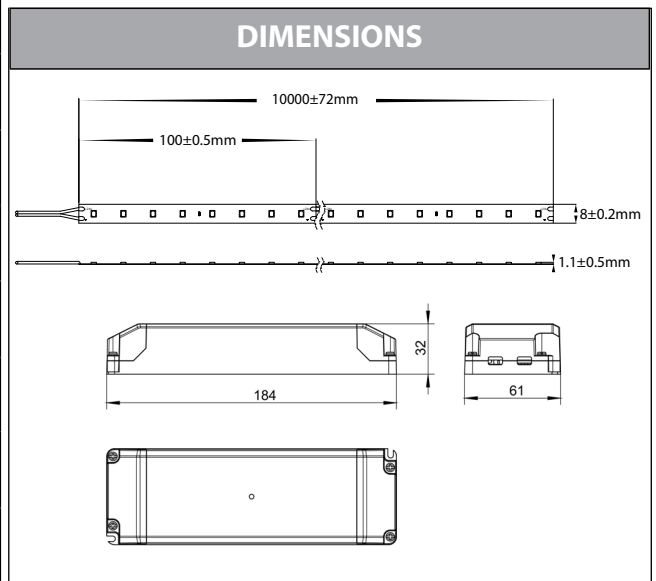

IMAGE	PART NUMBER	COLOUR TEMP	LUMENS PER METRE	INPUT VOLTAGE	INCLUDED IN KIT
	VPR9733IP20-60-10M	3000K	390lm	240v AC (Driver) 24v DC (LED Strip)	10m x 3000K IP20 LED Strip + 1x 60w LED Driver
	VPR9735IP20-60-10M	4000K	410lm	240v AC (Driver) 24v DC (LED Strip)	10m x 4000K IP20 LED Strip + 1x 60w LED Driver
	VPR9734IP20-60-10M	5500K	430lm	240v AC (Driver) 24v DC (LED Strip)	10m x 5500K IP20 LED Strip + 1x 60w LED Driver

For More Information Contact Havit Lighting

143 Beauchamp Road
Matraville NSW 2036
Australia

Tel: 02 9381 8300
Fax: 02 9666 888
Email: sales@havit.com.au
Web: www.havit.com.au