

Veko Aluminium Wall or Step Lights with Eyelid

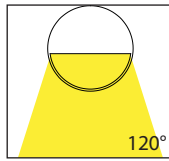

Product Specifications

Name	Veko
Material	Aluminium
Colour	Poly Powder Coated Black or White
IP Rating	IP65
IK Rating	IK10
Installation Type	Wall - Surface Mounted
Cable Length	300mm
Lamp Base	Built in LED
Max Wattage	2w
Protection Class	240v = 1 (Requires Earth)
	12v DC = 3 (No Earth Required)
Lamp Expectancy	>30,000hrs
Diffuser Type	Glass
CRI	CRI>80
Dimmable	No
Warranty	3 Years Replacement*

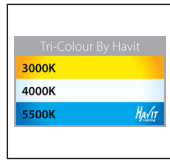

Optional Havit Compatible Accessories

Image	Part Number	Description
	12v DC LED Drivers	See Catalogue or Website for full range of 12v DC LED Drivers
	HV9911	Small IP67 Weatherproof Connector
	HV9912	Medium IP67 Weatherproof Connector
	HV9913	Large IP67 Weatherproof Connector

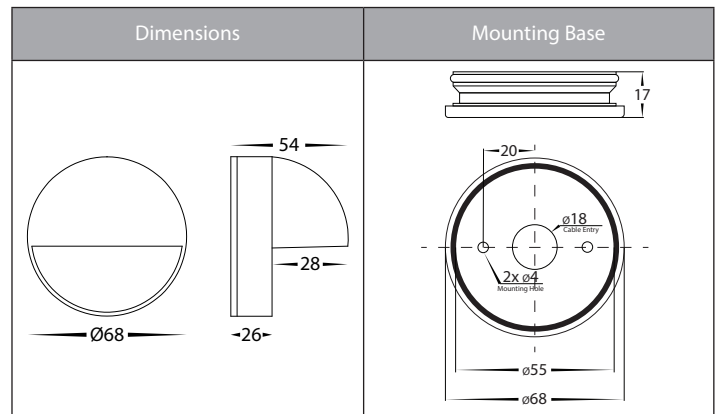

Product Ordering

Image	Part Number	Colour Temp	Lumens	Input Voltage	Beam Angle	Included LED	Barcode
	HV2927T-BLK-240V	3000k 4000k 5500k	100lm 110lm 105lm	240v AC	120°	TRI Colour 2w Built in LED	9350418033604
	HV2927T-BLK-12V	3000k 4000k 5500k	100lm 110lm 105lm	12v DC	120°	TRI Colour 2w Built in LED	9350418033628
	HV2927T-WHT-240V	3000k 4000k 5500k	100lm 110lm 105lm	240v AC	120°	TRI Colour 2w Built in LED	9350418033611
	HV2927T-WHT-12V	3000k 4000k 5500k	100lm 110lm 105lm	12v DC	120°	TRI Colour 2w Built in LED	9350418033635

*Items ordered after 01-01-2022

12v DC Models require an additional external LED Driver for installation.

Havit Lighting
143 Beauchamp Road,
Matraville, N.S.W. 2036

Phone: 02 9381 8300
Email: sales@havit.com.au
Web: www.havit.com.au



Warranty Terms & Conditions



www.havit.com.au