

LEDsmart⁺

Rotary Dimmer with built in on / off switch and multi-way control



- Suitable for one-way, two-way, three-way and multi-way dimming
- MultiMate™ technology allows multi-way dimming / switching with no extra wires
- Suitable for both retrofit and new installations
- Programmable minimum level, maximum level, kick-start, off state indicator and more
- Active only 'two wire' connection - no neutral required
- No separate switch required - built in switch
- 'Quick flick' dim to maximum or minimum dimming level
- Illuminated halo with interchangeable coloured rings (blue/green/orange/clear)
- Dim to OFF with most LED light sources
- Kid's bedroom mode – double tap when on to dim down over 30 minutes
- Wake up mode – double tap when off to dim up over 30 minutes
- Selectable fall-back LED Indicator level
- 1W minimum load

Patent Pending

Registered Design



Designed in Australia to meet
Australian Standards and
installation conditions



Product Item

This guide provides installation, setup and specification information for the LEDsmart⁺ Rotary Dimmer/Switch, item number **MMDM/RT**.

Product summary and capabilities

Designed in Australia to provide optimised dimming of LED based lamps and drivers, this high quality, two-wire phase control dimmer can be connected in parallel to other LEDsmart⁺ devices to provide a simple solution to multi-way control.

Although optimised for LED lighting loads, the dimmer also provides excellent compatibility with other common lamp types such as incandescent lamps, 12V halogen (dichroic) lamps and dimmable CFL's.

Programmable setup functions

Setup functions	Description
Minimum Brightness	If an LED or CFL lamp becomes unstable at low dimming levels, it can flicker or pulse on/off. The dimmer's minimum brightness can be set to a level above the point at which a lamp flickers/pulses
Maximum Brightness	The maximum brightness level provided by the dimmer can be set to suit customer requirements
Kick Start	This function is only required when dimming some LED and CFL lamp's. To ensure these lamps switch on, they require the dimmer output to be set to 50% for 0.2 of a second when the lamp is turned on. <i>Default: The Kick Start feature is switched off</i>
LED indicators	The dimmer's white LED indicators can be set to glow on or turn off when the dimmer is switched off <i>Default: The white LED indicators are set to glow on when the dimmer is turned off</i>
Separate Switch Mode*	Some lamps, such as non-dimmable CFL's, can flicker when switched OFF using the dimmer's integrated switch. In these cases, the dimmer can be used in 'Separate Switch Mode' and combined with a separate mechanical switch <i>Default: Separate Switch Mode is switched off</i>
Toggle / Memory Dimmer	The dimmer has the option to turn on at the brightness level set when the lights were turned off (memory dimmer), or to turn on at the maximum brightness level (toggle dimmer). <i>Default: the dimmer is setup as a toggle dimmer</i>
MultiMate™ ON/OFF	MultiMate™ functions can be switched ON or OFF <i>Default: MultiMate™ features are switched on</i>

* Note: Separate Switch Mode is suitable for single LEDsmart⁺ installations only. For multi-way installations, see the note below.



There are a wide range of LED and CFL lamps available from different manufacturers. The following issues are occasionally seen when used in conjunction with 2-wire dimmer/timer/switch products.

- When switched off, the LED/CFL lights flicker, pulse on/off or do not switch off completely
 - When switched off, the LEDsmart⁺ LED indicators flicker
 - When switching on, the LED/CFL lights have difficulty switch on and the dimmer indicators flicker or pulse
- It is recommended to install a Diginet 'Load by-pass' device (Diginet item number **MMBP**) across Load and Neutral terminals to provide improved performance of these lamps.

Multimate™ technology

MultiMate™ is a technology inside Diginet’s range of high quality LEDsmart⁺ dimmers, timers and electronic light switches. It allows multi-way control of lighting without the need for an expensive control system. MultiMate™ technology is suitable for both new and retrofit installations.

MultiMate™ technology enables multiple LEDsmart⁺ two-wire devices to be wired in parallel when two-way, three-way or multi-way dimming and switching is required. When connected in parallel LEDsmart⁺ dimmers allow dimming (and switching) of connected lighting loads from multiple locations without any additional wiring. No strapper wires, dedicated remote switch wiring or ‘control bus’ is required.

MultiMate™ is a patented technology, developed in Australia by Gerard Lighting.

The wiring example below shows three LEDsmart⁺ dimmers connected in parallel to provide three-way dimming and switching of four downlights without any additional wiring.

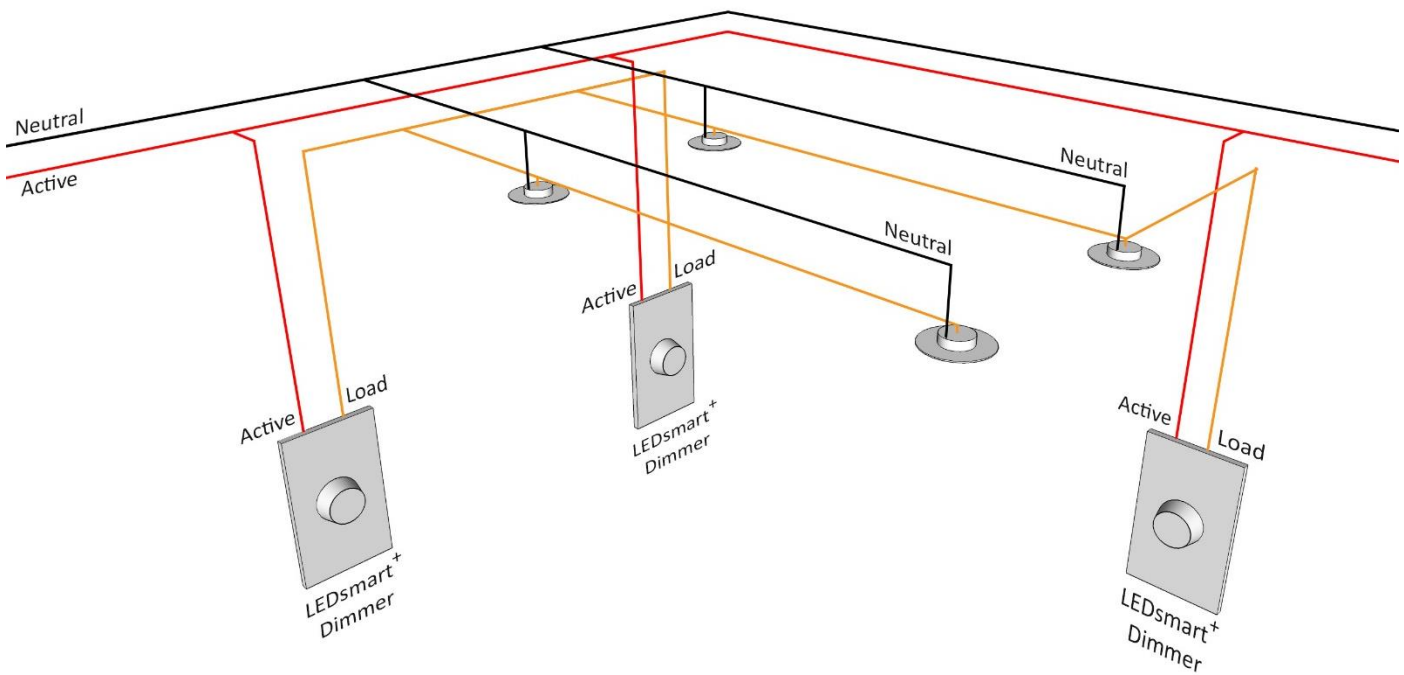

Products with MultiMate™ technology included

The following products all include MultiMate™ technology and can therefore be connected in parallel to allow multi-way control. Note that different types of MultiMate™ products can be connected in parallel. For example, switches and dimmers can be connected in parallel to control the same group of lights from different locations and/or provide additional functionality.

Product Range	Item Number	Type	Description
LEDsmart ⁺	MMDM/RT	Dimmer	Rotary Dimmer with built in on / off switch and multi-way control
LEDsmart ⁺	MMDM/PB	Dimmer	Push Button Dimmer with built in on / off switch and multi-way control
LEDsmart ⁺	MMSW/PB	Switch	Push Button Switch for LED lighting with built in on / off switch and multi-way control
LEDsmart ⁺	MMTM/PB	Timer	Push Button Minute Timer programmable between 1 minute and 30 minutes with built in multi-way control
LEDsmart ⁺	MMTH/PB	Timer	Push Button Hour Timer programmable between ¼ hour and 7½ hours with built in multi-way control

Dimmer installation



WARNING – This product must be installed by a suitably qualified installer

Electric shock may result in serious injury or death. Follow all warnings in this guide and on the product while working in accordance with the latest electrical safety practices for mains-powered electrical equipment.

The terminal block included with the dimmer should be used to carry out the electrical connections, as shown below

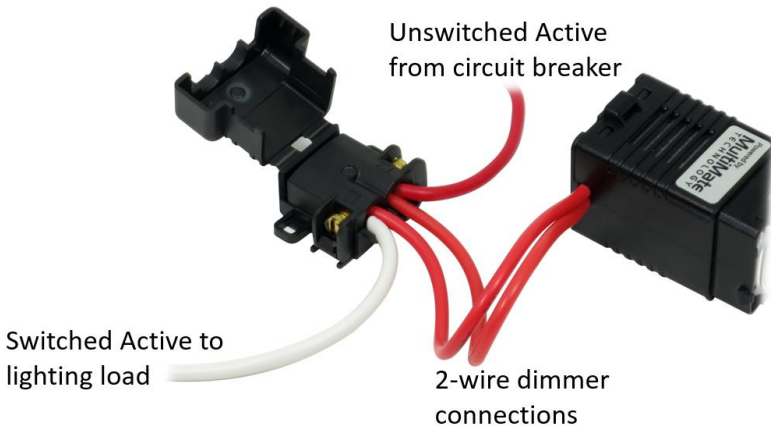

Once the connections have been made, the terminal cover is closed to ensure the screw terminals are not exposed

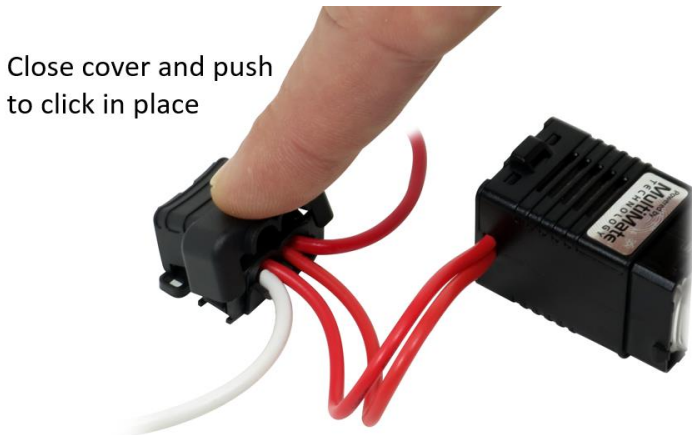

The terminal block can then be cable-tied to the rear of the dimmer housing utilising the two loop holes

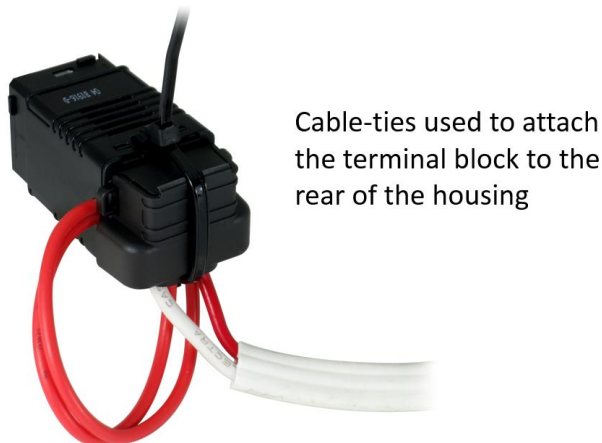

Wiring for one-way dimming and switching

The dimmer has a built in push on / push off switch as well as a rotary dimmer. Therefore, to provide both dimming and on/off control, no separate switch is required.

New Installation – one-way dimming and switching

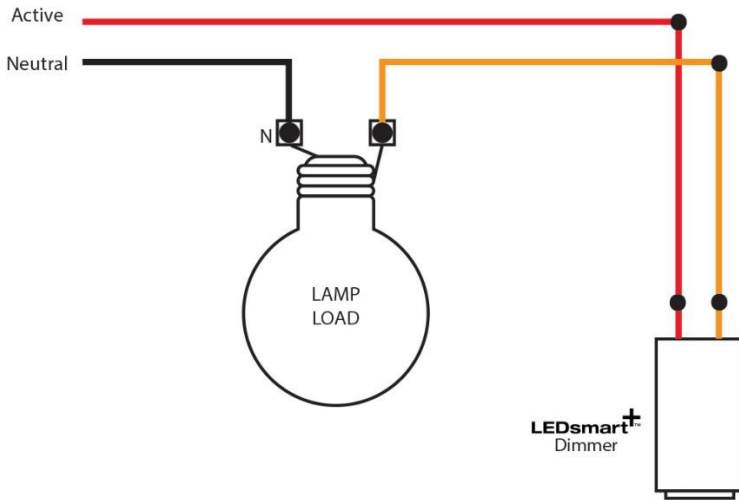

Replacing existing one-way switch with one-way switching/dimming

Existing one-way switching

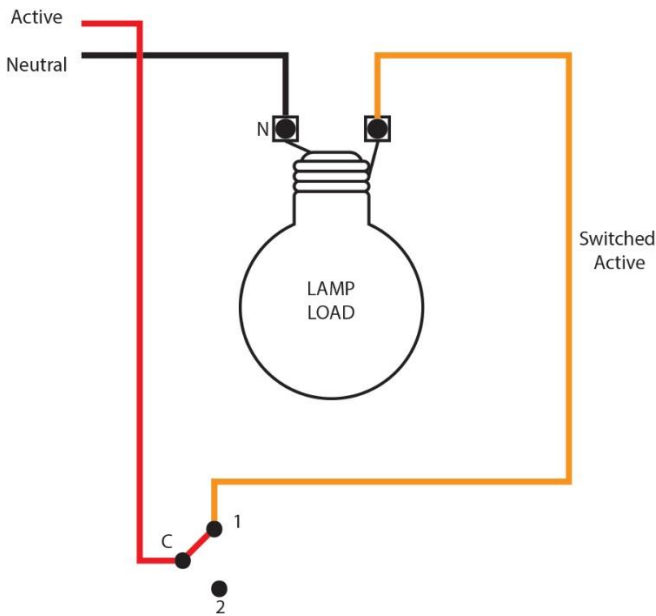

Replacement one way dimming/switching

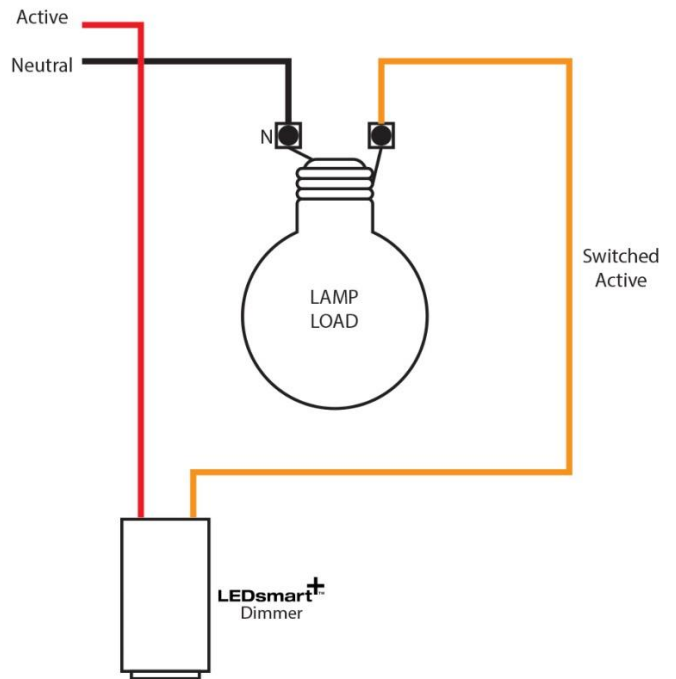

Wiring for two-way dimming and switching

To achieve two-way dimming and switching using LEDsmart⁺ dimmers, the two dimmers are connected in parallel. Note that the dimmers have an integrated switch, therefore no separate switches or additional strappers are required for two-way on/off control.

New Installation – two-way dimming and switching

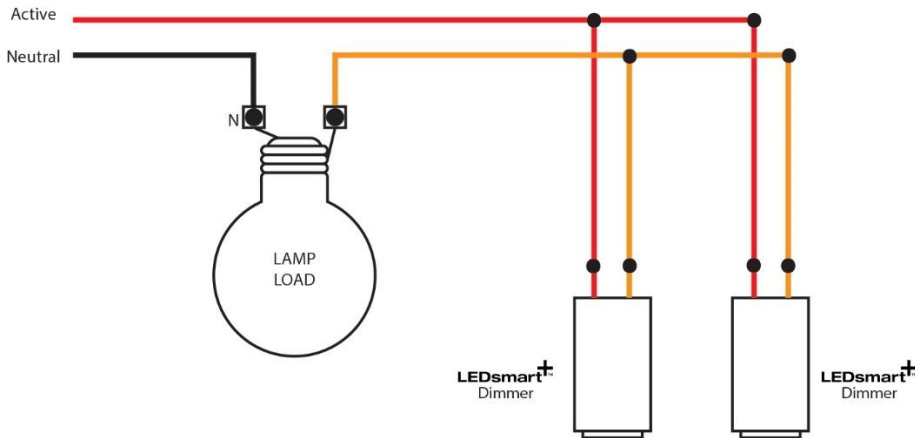

Two-way dimming and switching using LEDsmart⁺ dimmers. Note the two-wire dimmers are simply wired in parallel.

Replacing existing two-way switching with two-way dimming/switching

When replacing existing two-way switching with two-way dimming/switching using LEDsmart⁺, the existing two-way ‘strapper’ wires can be re-used. No new wiring is required. See the wiring diagrams below.

Existing two-way switching

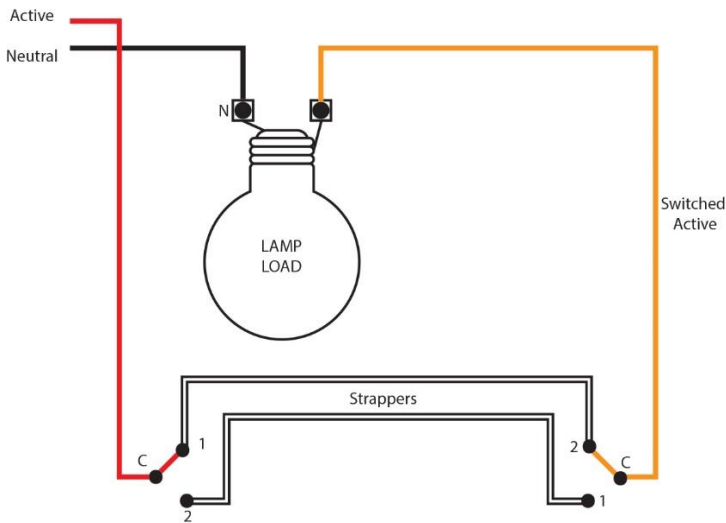

Traditional two-way switching using standard rocker switch mechanisms and strappers between the switches.

Replacement two-way dimming/switching

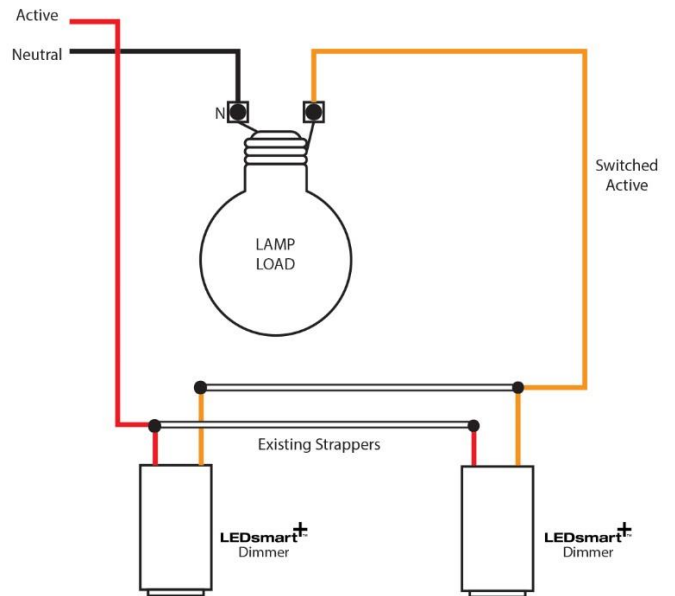

Rocker switches replaced with LEDsmart⁺ dimmers using the existing strapper wires. No new wiring required.

Wiring for multi-way (three-way or more) dimming and switching

To achieve multi-way dimming and switching using LEDsmart⁺ dimmers, the required number of dimmers can be connected in parallel. Note that each LEDsmart⁺ dimmer has an integrated switch, therefore no separate switches or additional strappers are required to provide multi-way dimming and on/off control.

The diagram below shows the required wiring for three-way dimming and switching using LEDsmart⁺ dimmers. If more than three-way control is required, further LEDsmart⁺ devices are simply wired in parallel.

New Installation – multi-way (three-way or more) dimming/switching

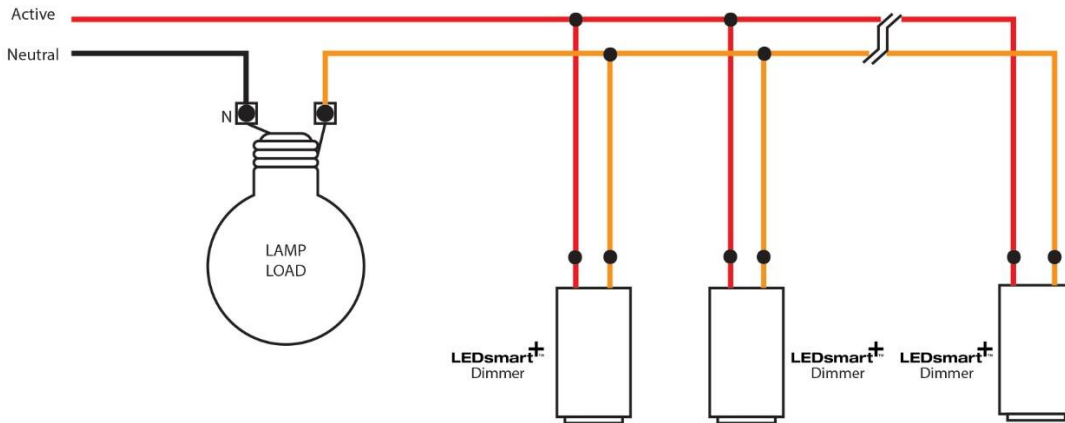

Three-way dimming and switching using LEDsmart⁺ dimmers. Note that each two-wire LEDsmart⁺ dimmer is simply wired in parallel.

Replacing existing multi-way switching with multi-way dimming and switching

Existing three-way switching

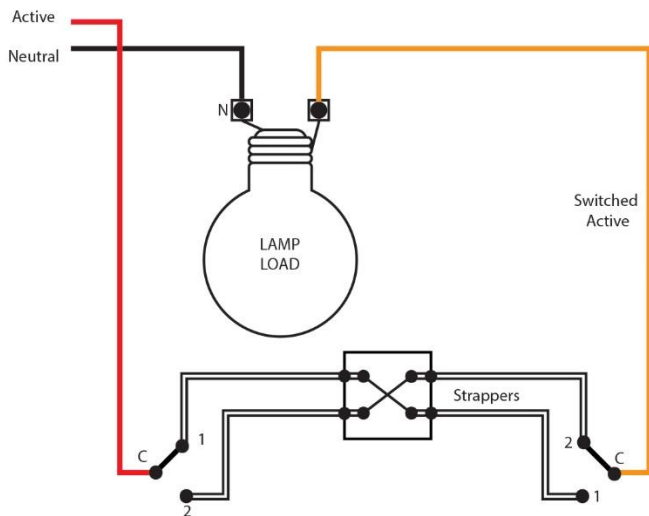

Traditional three-way switching using two rocker switches and one intermediate switch, with strappers between the switches.

Replacement three-way dimming/switching

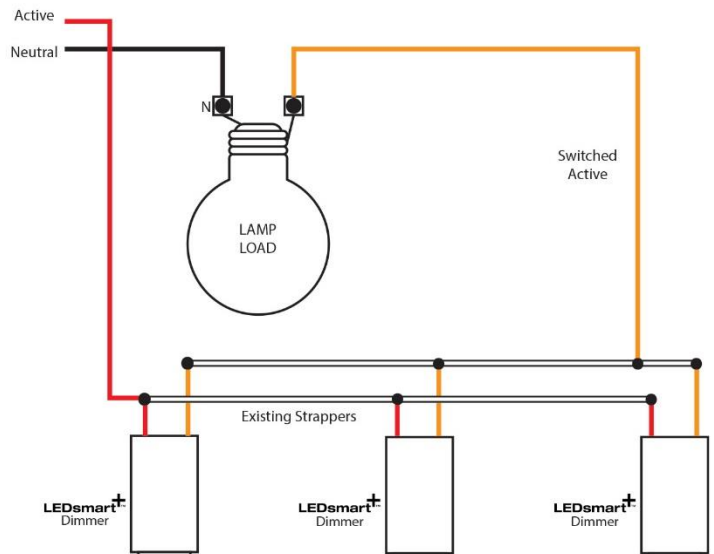

Rocker switches and intermediate switch replaced with LEDsmart⁺ dimmers. The existing strappers are used to connect the dimmers in parallel. No new wiring is required.

Rotary / Push Dials

Two different sizes of rotary/push dials are included. Either can be used depending on customer preferences. In general, the dials are used as follows.

Type	Best Suits
Smaller rotary dial	Wall plates with 2 or more gangs
Larger rotary dial	1-gang wall plates

Coloured Indicator Rings

Out of the box, the large and small rotary/push dials are fitted with a clear silicon indicator ring. As the dimmer LED indicator is white, the clear silicon indicator ring provides a soft white glow when on.

Blue, green and orange silicon rings are also included with the dimmer. These can be used to match customer colour preferences, or to more easily identify different dimmers on the same grid plate.

Installing LEDsmart⁺ devices into Clipsal Saturn™ or Clipsal Saturn Zen™ wall plates

Adaptor kits are available separately to enable LEDsmart⁺ devices to be installed into Clipsal Saturn™ or Clipsal Saturn Zen™ wall plates. Order codes are as follows.

DGACCESSPK2	Adaptor kit for LEDsmart ⁺ Push Button devices
DGACCESSPK3	Adaptor kit for LEDsmart ⁺ Rotary dimmers

Dimmer Setup

The LEDsmart⁺ rotary dimmer has a number of useful functions which can easily be set up by entering setup mode and following four easy steps.

It is recommended that the MINIMUM BRIGHTNESS is always setup. The other settings are optional, depending on the dimmer application. To set the minimum brightness now, go to the next page.

Dimmer Setup Functions

Function	See Part
Entering Setup Mode	See page 9
Setting Minimum Brightness	See page 10
Setting Maximum Brightness	See online guide
Setting the Kick Start Feature	See online guide
Setting Off State LED Feature	See online guide
Setting Separate Switch Mode	See online guide
Setting Toggle / Memory Dimmer	See online guide
Setting MultiMate™ Mode	See online guide
Factory Defaults Reset	See online guide

A: Entering Setup Mode

Before starting to setup the dimmer, the rotary dial should be removed by pulling it off the shaft. This allows the white LED indicator to be easily seen during setup.

If the dimmer has been powered up for **LESS THAN 30 MINUTES** see **A1** below.

If the dimmer has been powered up for **MORE THAN 30 MINUTES** see **A2** below.

 Once in Setup Mode, options are selected by a series of 'clicks' of the dimmer rotary shaft. Each 'click' should be approximately 1 second after the previous click.

Remove dial!

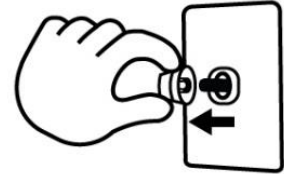

A1: Dimmer has been powered up via mains 240Vac for LESS THAN 30 MINUTES

Step 1 Press and hold the dimmer rotary shaft for 10 seconds
Note: Connected lights will dim up or down, this is normal

Press & Hold!



Step 2 The white LED Indicators will blink ON/OFF twice per second. This indicates that the dimmer is now in Setup Mode

Note: If more than one LEDsmart⁺ device is connected in parallel (see pages 5-7), all these devices will now enter setup mode. The blink ON/OFF will also be seen on all other LEDsmart⁺ devices connected in parallel

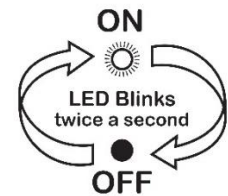

In the unlikely event that other LEDsmart+ devices connected in parallel do not enter setup, exit and try again.

Step 3 The dimmer is ready for the settings to be adjusted as required. Go to the relevant setup function instructions



A2: Dimmer has been powered up via mains 240Vac for MORE THAN 30 MINUTES

Step 1 Press and hold the dimmer rotary shaft for 30 seconds
Note: This resets the Setup Entry time back to 10 seconds (for the next 30 minutes)
Note: Connected lights will dim up or down, this is normal

Press & Hold!



Step 2 The white LED Indicators will blink ON/OFF twice per second. This indicates that the dimmer is now in Setup Mode

Note: If more than one LEDsmart⁺ device is connected in parallel (see pages 5-7), all these devices will now enter setup mode. The blink ON/OFF will also be seen on all other LEDsmart⁺ devices connected in parallel

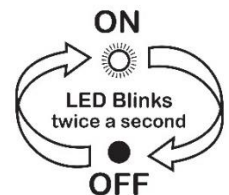

In the unlikely event that other LEDsmart+ devices connected in parallel do not enter setup, exit and try again.

Step 3 The dimmer is ready for the settings to be adjusted as required. Go to the relevant setup function instructions



B: Setting Minimum Brightness

The minimum brightness level provided by the dimmer can be set to suit specific lamps and/or customer requirements.

For the majority of lamps a minimum level as low as 0% can be set if required. However, some lamps can become unstable at low dimming levels, in particular CFL's.

If lamps become unstable at low dimming levels, they typically flicker or pulse on/off. The dimmer allows the minimum brightness to be set to a level above the point at which the lamp flickers/pulses.

Step 1 Enter into the dimmer Setup Mode - See PART A (page 9)

Setup Mode!



Step 2 Click the dimmer rotary shaft twice



Step 3 LED will blink 2 times

Note: To cancel/exit do nothing for 30 seconds

Note: If more than one dimmer is connected to the same load (see pages 5-7), all dimmers connected to this load will now blink 2 times

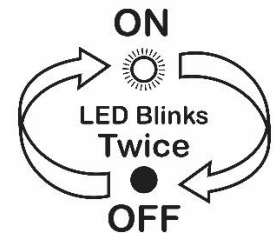

Step 4 Adjust dial to required MINIMUM brightness level

Note: If more than one dimmer is connected in parallel (see pages 5-7), wait for 3 seconds for the other connected dimmer to learn the new minimum level

Note: To cancel/exit do nothing for 30 seconds

Adjust!

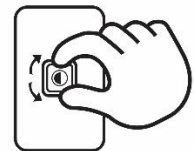

Step 5 Click once to save & exit

Note: If more than one LEDsmart⁺ device is connected in parallel, the minimum brightness levels **only needs to be set in one device**. The setting is automatically saved to all other devices connected in parallel



In the unlikely event that other LEDsmart⁺ devices connected in parallel do not enter setup, exit and try again.

Specifications

Nominal Line Voltage Amplitude Range	220-240Vac
Line Voltage Frequency	50Hz Nominal (47 – 53Hz)
Load Brightness Control Range	0% to 100% (typical for LED loads)**
Rated Load	Refer Compatible Loads table (below)
Minimum Load	1W
Maximum cable distance from any LEDsmart ⁺ device to the parallel junction point	50m (for example, two dimmers can be separated by up to 100m provided that the maximum distance from the furthest dimmer to the parallel junction point is no more than 50m)



** Some LED lights do not turn off completely when used with two wire devices such as LEDsmart⁺. This is due to the small amount of current which flows through the device to the load when switched off. The result with some LED light sources can be a small amount of light output when the LEDsmart⁺ is in the off position. If this occurs, it is recommended that a Diginet 'Load by-pass' device (Item **MMBP**) is added to the lights / dimmer installation.

Compatible Load Types

Load Symbol	Load Types	Max Load	Notes
	Dimmable LED Lamps	400W	The LED driver must be dimmable. Maximum permitted number of drivers is 400W divided by the driver nameplate power rating. Due to variety of LED lamp designs, maximum number of LED lamps is also dependent on power-factor result when connected to dimmer.
	Electronic Transformers	400W	
	Standard iron-core transformers	250W	Due to variety of transformer designs, max LV lighting load is also dependent on transformer efficiency.
	Toroidal iron-core transformers	300W	
	Incandescent	350W	
	Dimmable CFLs	400W	Due to the variety of CFL designs, the maximum number is make/model dependent.

Incompatible Load Types

Ceiling Sweep Fans and Exhaust fans.

Multi-Gang De-Rating

Number of times per plate	De-rating factor
1	No de-rating
2	0.85
3	0.7
4	0.55
5	0.4
6	0.25

In applications where multiple dimmers are installed in a multi-gang plate, a de-rating factor is applied to the maximum load as follows.

De-rating Example
Two LEDsmart ⁺ devices installed in a wall plate. The maximum LED load which can be connected to each device = 400W x 0.85 = 340W per device.



Warranty

This product is covered by a two-year warranty against manufacturing defects. This warranty is provided in addition to consumer guarantees covered by Australian Consumer Law.

Trademarks

The identified trademarks and copyrights are the property of Gerard Lighting unless otherwise noted.

Clipsal Saturn™ and Clipsal Saturn Zen™ are trademarks of Schneider Electric (Australia) Pty Ltd

© Copyright

This user and installation guide is copyright to Gerard Lighting. Except as permitted under relevant law, no part of this user and installation guide may be reproduced by any process without written permission of and acknowledgement to Gerard Lighting.

Gerard Lighting Pty Ltd (Gerard Lighting) reserves the right to alter the specifications, designs or other features of any items and to discontinue any items at any time without notice and without liability. While every effort is made to ensure that all information in this user and installation guide is correct, no warranty of accuracy is given and Gerard Lighting shall not be liable for any error.

Printed on recycled paper

DIGINET.NET.AU

Product of Gerard Lighting Pty Ltd

ABN 94 122 520 307
96-112 Gow Street
Padstow NSW 2211

Contact

General Enquiries: 1300 95 DALI (3254) or sales@dignet.net.au
Technical Services: 1300 95 3244 or support@dignet.net.au
Fax: 1300 95 3257

Dignet is a brand of the Gerard Lighting Group

Version: Issue 1 June 2016

Item 14-14-013D-01-01

INTRODUCTION

LEDsmart+ dimmers, timers, switches and occupancy sensors include MultiMate™ technology. These devices have revolutionised multiple point control of lighting whilst using conventional wiring practices.

Even when not used for multi-way control, their superior compatibility with LED lighting loads makes them the best wall plate lighting controls in the market.

MULTIMATE™ TECHNOLOGY

MultiMate™ is the technology inside the range of high quality LEDsmart+ dimmers, timers, switches and occupancy sensors. It allows multi-way control of lighting loads without the need for an expensive control system. MultiMate™ technology is suitable for both new and retrofit installations.

MultiMate™ technology enables multiple LEDsmart+ two-wire devices to be wired in parallel when two-way, three-way or multi-way dimming and switching is required.

When connected in parallel, LEDsmart+ dimmers, timers, switches and occupancy sensors allow dimming and switching of connected lighting loads from multiple locations without any additional wiring. No strapper wires, dedicated remote switch wiring or control bus is required.

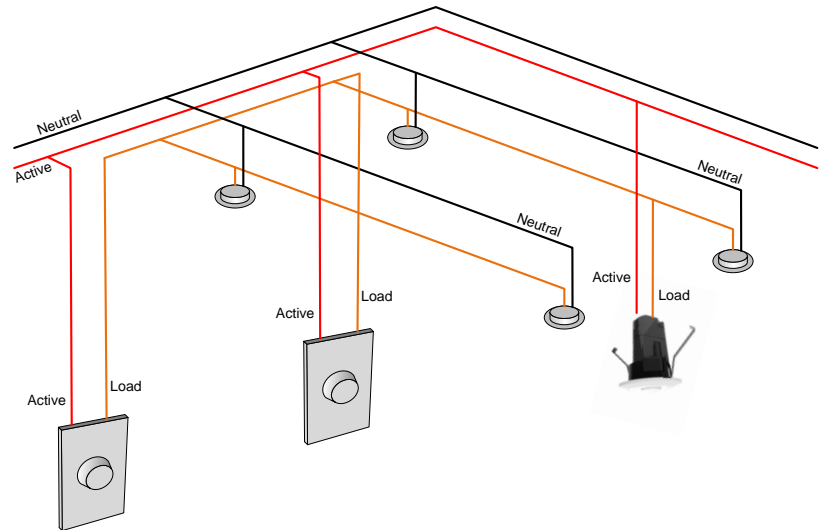

HOW MULTIMATE™ WORKS

MultiMate™ products use a patented method of communicating with each other using the mains wiring. By this means dimmers, timers, switches and occupancy sensors can communicate on/off, level, and settings to other LEDsmart+ products on the same circuit.

INSTALLATION

In normal cases, existing switches can be removed and replaced by MultiMate™ dimmers, timers, switches and occupancy sensors. Please refer to the installation instructions for common wiring methods used for 1-way, 2-way, 3-way and other configurations.

TROUBLESHOOTING

Like all products, sometimes there can be problems caused by the electrical behaviour of the building wiring, or that of the lighting loads. This document describes some cases found from real-world product experience and their solutions.

Each of the following pages describes a problem and solution. In some case additional product(s) may be required.

APPLICABLE PRODUCTS

Dimmers:	MMDM/PB & MMDM/RT
Timers:	MMTM/PB & MMTH/PB
Switches:	MMSW/PB
Occupancy Sensors:	MMSE/PR

FLICKERING OR FLASHING WHEN OFF OR AT LOW DIMMING LEVELS

Modern LED lighting has revolutionised high brightness low power lighting.

Unfortunately, some LED loads can have problems with dimmer compatibility. This can be observed when lamps flicker or flash when set to low dimming levels or when a MultiMate™ device is set to the OFF condition.

The MMBP load bypass is wired across the lamp. It will resolve almost all issues associated with dimming of LED lighting, including:

- Lamp glow when turned off;
- Flickering or pulsing of the lamp when turned off or to low dimming levels; and
- Flickering or pulsing of the dimmer LED status indicators.

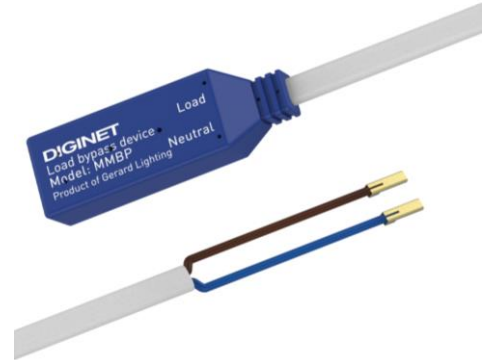

Solutions for lamp flickering at low dimming levels

Solution 1: Use the setup functions of the dimmer, timer, switch or occupancy sensor to adjust the MINIMUM dimming level to a higher value. Refer to the product installation guide for details.

Solution 2: Fit a load bypass device – order code MMBP.

Solution 3: In extreme cases, both the MMBP and a raised minimum level may be needed.

Solutions for flickering or pulsing of dimmer LED status indicators.

Solution 1: Fit a load bypass device (MMBP).

Solution 2: Newer model dimmers introduce CLM mode. Use the setup guide for your product and activate CLM mode.

Solution 3: In extreme cases, both the MMBP and enabling CLM mode may be needed.

Solutions for lamp flickering or flashing when turned OFF

Fit an MMBP load bypass. It is designed for this issue. Similar products are also available from other manufacturers.

How to install the MMBP load bypass device

The MMBP load bypass device is installed **in parallel with the load, across the switched Active and Neutral**, as shown in the diagram below.

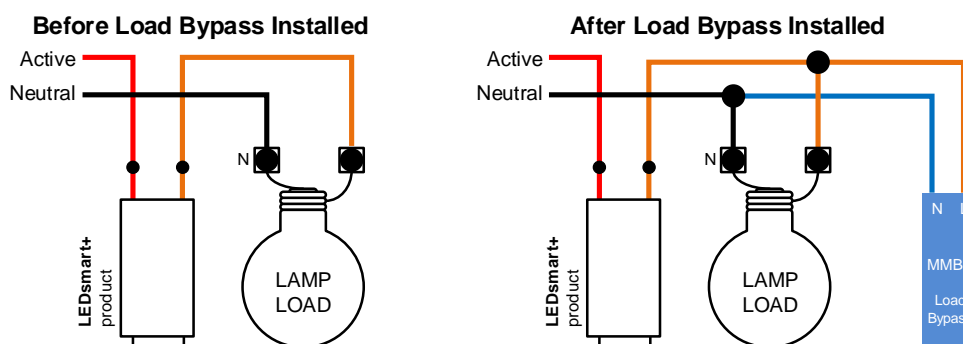

Caution: Do not wire the MMBP across the dimmer terminals. This will not be effective.

CROSSTALK

Crosstalk happens when several MultiMate™ circuits are installed in the same building, and adjustments on one circuit cause interference on another circuit. The interference may be observed as:

- Lighting changes on one circuit cause lighting changes (on / off / change of level) on some other circuit; or
- Lighting changes on one circuit cause another circuit to turn off.



If a lighting load is flickering or flashing at low dimming levels or when turned off (and no dimmer / timer / switch is being adjusted) the most likely cause is a poorly designed lighting load. In that case, please refer to the section “Flickering or flashing when off or at low dimming levels”.

Causes

If the mains supply has a high source impedance, this can cause crosstalk: where the communication of one set of dimmers interferes with adjacent dimmers – especially if the different dimmer circuits share a common active feed to the same switch plate.

Reasons for High source impedance may include one or a combination of:

- Old substation or local step-down transformer running close to maximum capacity;
- Long cable run from step down transformer to building;
- High resistance terminations on active feeds and/or neutral returns; and
- Neutral returns from a common active feed having significantly different run lengths back to the switchboard – good practice would be to link together neutral returns from a common active feed as close as possible to the loads.

A best practice is for wiring from the distribution panel to the multi-way control location to use twin & earth cabling, keeping active & neutral together for as long as possible. This results in the lowest supply impedance. Long runs of single-cable active wiring and separate neutral wiring should be avoided.

Solution when the Multi-way function is not required

If the multi-way dimming function is not being used: follow the directions in the product Setup Guide to disable the MultiMate™ operation. This prevents the dimmer / timer / switch / sensor from sending and receiving the MultiMate™ commands.

Change this setting for all affected dimmers in the building when multi-way dimming is not needed.

Solution when the Multi-way function is required

When the multi-way dimming function is required, an inline MMDM/ID Inductive Decoupler may be required – these should be connected between the last dimmer in the control chain and the load.

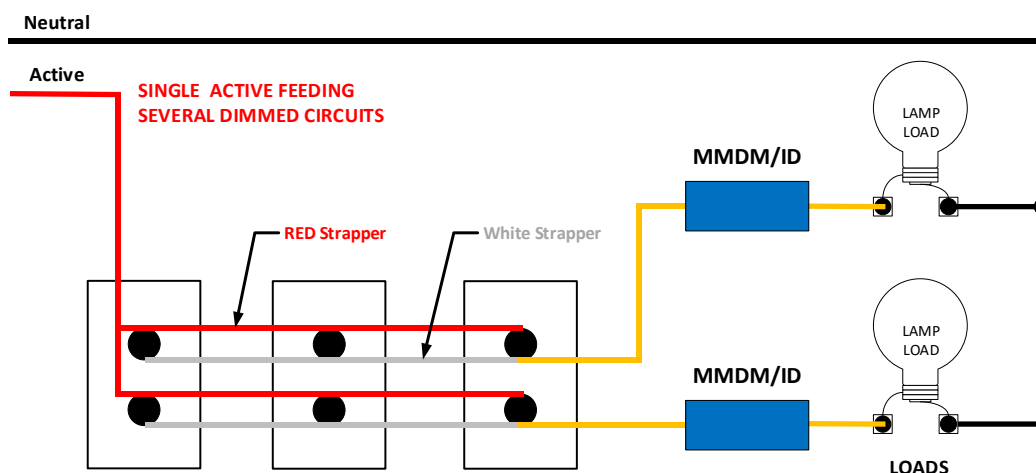

FANS, FLUORESCENT LIGHTING AND NON-DIMMABLE LOADS

MultiMate™ dimmers, timers, switches and occupancy sensors are designed to control dimmable lighting loads.

Sometimes these products need to control non-dimmable loads, for example fluorescent lighting, non-dimmable LED lamps, or bathroom exhaust fans.

Direct wiring of these loads to MultiMate™ products may cause incorrect function of the load or the MultiMate™ product.

To Control fans and non-dimmable loads

The MMSR MultiMate™ Slave Relay presents a dimmable load to MultiMate™ devices. When the dimmer level exceeds a threshold, the relay is operated and switches on a non-dimmable load.

Combinations loads are possible on a dimmer: a dimmable LED load may be used on the same circuit as non-dimmable loads. In this case, when the dimmer level is higher than a threshold, the relay is operated to switch the non-dimmable load(s) on and the dimmable load will continue to respond normally. This is shown in the wiring diagram below.



Properties of the MMSR Slave Relay

The Slave Relay has voltage-free contacts, and is rated at 10AX. SELV load control is possible when using the isolating barrier that is included.

The Slave Relay is suitable for use with trailing edge phase control dimmers. The Slave Relay can satisfy the load requirements of LEDsmart+ dimmers / timers / switches or occupancy sensors by itself. Using an additional dimmable lighting load is optional.

How to wire in the MMSR Slave Relay

