



EMIT-25-RGBW-BRS

RGBW Inground Light - Brushed Brass

Description

Introducing the EMIT-25 RGBW LED Inground Light Series. The EMIT-25 RGBW is a mini inground light with a cutout of 19mm, ideal for lighting up features where minimalistic light effects are required. Featuring a 1W LED output, with a range of different fascia plates and metalware colour options. Choose from Round Open, Square Open, Eyelid and Halo fascias, as well as the multiway fascias available in 1WAY, 2WAY, 3WAY, and 4WAY. Metalware colour options range from Black, Stainless Steel, Antique Brass and Brushed Brass. RGBW Colour Changeable with the use of an RGBW Colour Controller. Colour selectable from RGB as well as White colours. Functional with 24V DC Constant Voltage LED Drivers. Optional extra accessories such as narrow to medium Beam Angle Lens as well as Honeycomb and frosted diffusers are also available. Part of a family of different sizes to suit most inground lighting applications. Backed by a 5 Year Replacement Warranty.

Specification Features

Input Voltage:	24V DC
Power (W):	1W
IP rating (IP):	IP67
IK Rating (IK):	IK10
LED type:	CREE
CCT:	RGBW
Beam angle (°):	19° - 36° - 60° (36° Standard)
Dimmable:	No
Lifespan (hrs):	50,000hrs
Cutout (Ø):	Ø19mm Without Cannister Ø24mm With Cannister

Requires RGBW Colour Controller (Suggested Controller - CHAM-BT-RF-5C 20141)

Requires a 24V Constant Voltage LED Driver (Wire in Parallel)



RO-BRS



SQ-BRS



EYELID-BRS



HALO-BRS



RING-BRS



1WAY-BRS



2WAY-BRS



3WAY-BRS



4WAY-BRS



Honeycomb (Optional)
Variant: 10080



Opal Diffuser (Optional)
Variant: 10081



19° Lens (Optional)
Variant: 10082



60° Lens (Optional)
Variant: 10085

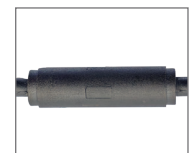

Water Stop Cable Joint

Item No.	Variant									CCT
	RND OPEN	SQR OPEN	EYELID	1WAY	2WAY	3WAY	4WAY	HALO	RING	
EMIT-25-RGBW-BRS	10060	10061	10062	10063	10064	10065	10066	10067	10068	RGBW

Diagrams / Additional

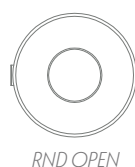
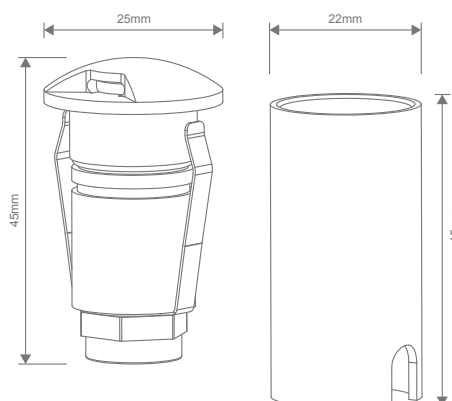

RND OPEN

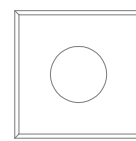

SQR OPEN

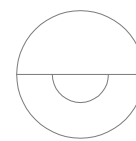

EYELID

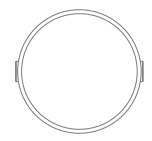

HALO & RING

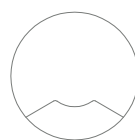

1WAY

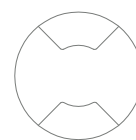

2WAY

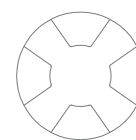

3WAY

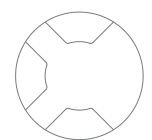

4WAY