



# STINGER LED FLOOD LIGHT



**240V/  
50Hz**

**10W  
850LM**

**20W  
1700LM**

**IP44  
WEATHER  
RESISTANT**

**3YR  
WARRANTY**

**PIR  
SENSOR**

**The Stinger flood light is a classic design solution to light up walkways and dark areas around your home. The energy efficient LED light providing illumination, safety and convenience.**

- Classic design that can be installed both on the wall and on the ceiling under the eaves.
- Latest in ultra-bright COB LED technology, with built-in 10W LEDs
- Light up the right area using the fully adjustable heads.
- Projects a broad beam of light.
- Advanced PIR motion sensing.
- Sensor range of 150 degrees x 12 metres.
- Made from durable UV stabilised polycarbonate offering you a rust free solution that is ideal for coastal environments.

## APPLICATIONS

- Great for use in entrances, patios, gardens, exterior walls and for lighting up walkways and medium sized areas. Ideal for coastal areas.
- Suitable for residential and commercial applications.

22287/05: WHITE



22287/06: BLACK



22289/05: WHITE



22289/06: BLACK



22822/05: WHITE



22822/06: BLACK



22824/05: WHITE



22824/06: BLACK





# STINGER LED FLOOD LIGHT









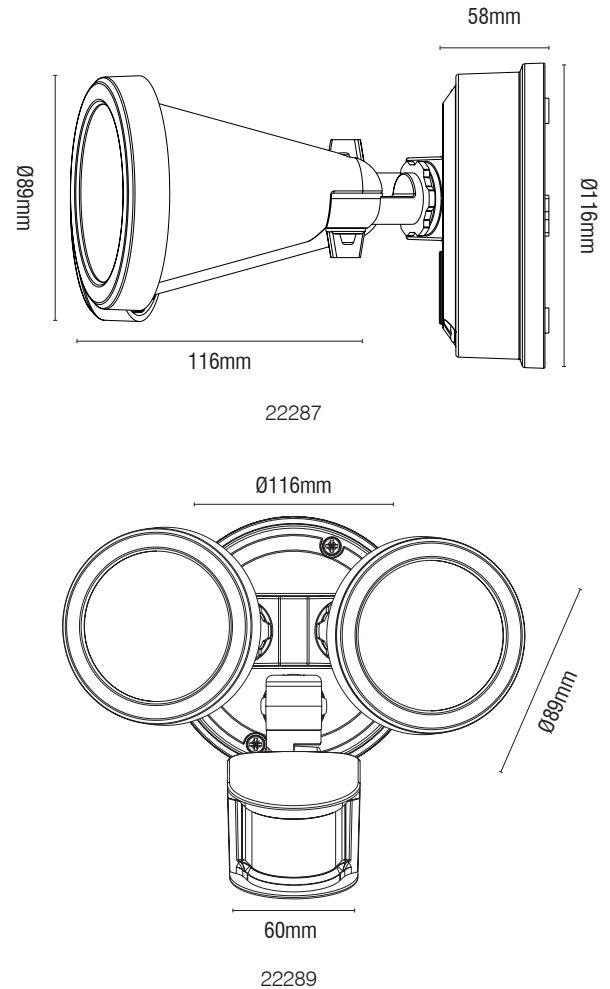
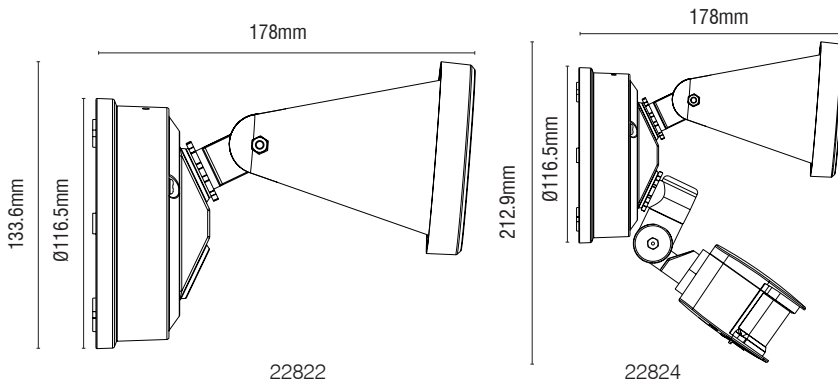







## TECHNICAL SPECIFICATIONS

|                            |  |
|----------------------------|--|
| <b>Operating voltage:</b>  | 240V 50Hz  |
| <b>Class:</b>              | Class II   |
| <b>Wattage:</b>            | Single: 10W Total, Twin: 20W Total                                   |
| <b>Lumens:</b>             | Single: 850lm, Twin: 1700lm  |
| <b>Colour Temperature:</b> | Cool White   |
| <b>Motion Detection:</b>   | Advanced PIR motion sensing  |
| <b>Operation Modes:</b>    | Manual Override  |
| <b>PIR range:</b>          | 12m x 150 degrees  |
| <b>Light time on:</b>      | Adjustable time: 10±5sec - 4±1min<br>(restarts when motion detected) |
| <b>Lux sensitivity:</b>    | 5 to 2000 Lux  |
| <b>Dimming:</b>            | No   |
| <b>Construction:</b>       | Durable polycarbonate construction (casing)<br>Tempered glass (lens) |
| <b>Ingress protection:</b> | IP44 rated   |
| <b>Warranty:</b>           | 3 year replacement   |

## INSTALLATION

Must be installed by a licensed electrician



|                   | MODEL | COLOUR                 | DESCRIPTION                                   | BOX SIZE              | GROSS WEIGHT | BOX QTY | BARCODE   |
|-------------------|-------|------------------------|---|-----------------------|--------------|---------|---|
| <b>RETAIL BOX</b> | 22287 | /05 White<br>/06 Black | Stinger LED Twin Flood Light                  | W180 x H120 x D185 mm | 0.53 kg      | 1 pc    |   |
| <b>OUTER CTN</b>  | 22287 | /05 White<br>/06 Black | Stinger LED Twin Flood Light                  | W375 x H225 x D390 mm | 4.24 kg      | 8 pc    |   |
| <b>RETAIL BOX</b> | 22289 | /05 White<br>/06 Black | Stinger LED Twin Security Light with Sensor   | W180 x H120 x D185 mm | 0.68 kg      | 1 pc    |   |
| <b>OUTER CTN</b>  | 22289 | /05 White<br>/06 Black | Stinger LED Twin Security Light with Sensor   | W375 x H225 x D390 mm | 5.44 kg      | 8 pc    |   |
| <b>RETAIL BOX</b> | 22822 | /05 White<br>/06 Black | Stinger LED Single Flood Light                | W120 x H185 x D120 mm | 0.45 kg      | 1 pc    |   |
| <b>OUTER CTN</b>  | 22822 | /05 White<br>/06 Black | Stinger LED Single Flood Light                | L255 x W255 x H390 mm | 3.80 kg      | 8 pc    |   |
| <b>RETAIL BOX</b> | 22824 | /05 White<br>/06 Black | Stinger LED Single Security Light with Sensor | W185 x H160 x D120 mm | 0.55 kg      | 1 pc    |   |
| <b>OUTER CTN</b>  | 22824 | /05 White<br>/06 Black | Stinger LED Single Security Light with Sensor | L335 x W255 x H390 mm | 4.90 kg      | 8 pc    |   |