

# DALI-2 IP67 Power Supplies

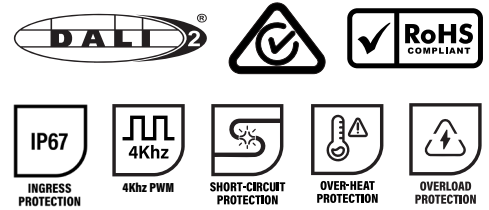

## Features

- **Universal Input Voltage:** 85 – 265 VAC for global compatibility.
- **Safety First:** Fully isolated design ensures maximum operational safety.
- **Superior Dimming:** Smooth dimming performance with broad dimmer compatibility.
- **Advanced Standards:** Fully compliant with DALI 2.0 (IEC 62386) protocols.
- **All-Weather Durability:** IP67 rated for indoor and outdoor applications (Note: Do not cover when used indoors).
- **Comprehensive Protection:** Built-in safeguards against short circuits, over-current, and over-voltage.
- **Certified Quality:** CE, TUV, ETL, and UL certified.
- **High Efficiency:** Features Active Power Factor Correction (PFC) for optimized energy use.
- **5-Year Warranty:** Long-term reliability guaranteed.

**Warning:** Optimised for Direct Drive LEDs such as LED Strip and 24V COB LED light fittings. Performance may vary if used with LEDs containing integrated driver circuits or capacitive loads.

## Part Numbers

Code	Wattage
AQD-24-030-B-D	30W
AQD-24-060-B-D	60W
AQD-24-100-B-D	100W
AQD-24-150-B-D	150W
AQD-24-200-B-D	200W

## Technical Parameters

	Parameter	Unit	AQD-24-030-B-D	AQD-24-060-B-D	AQD-24-100-B-D
Output	Voltage	V	24	24	24
	Current	A	1.25 (Max)	2.5 (Max)	4.15 (Max)
	Power	W	30	60	100
	Ripple & Noise (max)	mV	300	300	300
	Channel	-	1	1	1
	Voltage Tolerance	-	±5%	±5%	±5%
Input	Input Voltage	VAC	85-265	85-265	85-265
	Frequency	Hz	50/60	50/60	50/60
	Power Factor	-	>0.95	>0.95	>0.95
	THD	-	<15%	<15%	<15%
	Standby Power	W	<1	<1	<1.5
	Current	A	<0.35	<0.7	<1.1
	Inrush Current	A	75	75	75
	Efficiency Full Load 110VAC	-	85%	90%	90%
	Efficiency Full Load 230VAC	-	86.50%	91%	91.5%
	Start 230VAC (milliseconds)	ms	<200	<200	<200
	Rise Time 230VAC (milliseconds)	ms	<150	<150	<150
Hold Time 230VAC (milliseconds)	ms	>20	>20	>20	
Dimming	Protocol	-	DALI2	DALI2	DALI2
	Output Frequency	Hz	4K	4K	4K
	Dimming Ratio	-	1%-100%	1%-100%	1%-100%
	Dimming Compatibility	-	90%	90%	90%
	Minimum output current	-	-	-	-
	Maximum output current	A	1.25	2.5	4.15
Protection	Short Circuit	-	Yes	Yes	Yes
	Over Voltage	-	Yes	Yes	Yes
	Over Load	-	Yes	Yes	Yes
Safety & EMC	Lighting Strike	KV	1.5	2.5	2.5
	Withstand Voltage	VAC	3750	3750	3750
	Safety Standards	-	EN IEC 55015	EN IEC 55015	EN IEC 55015
	EMC Emission EMC	-	EN IEC 61000-3-2	EN IEC 61000-3-2	EN IEC 61000-3-2
	EMC immunity EMC	-	EN IEC61547	EN IEC61547	EN IEC61547
	Safety Approval Mark	-	SAA RCM	SAA RCM	SAA RCM
Environment	Working Temperature	°C	-20-40	-20-40	-20-40
	Storage Temperature	°C	-20-80	-20-80	-20-80
	TC	°C	75	75	75
	Housing Material	-	Aluminum shell	Aluminum shell	Aluminum shell
	IP Rating	IP	IP67	IP67	IP67
	Lifetime	Hrs	50000H	50000H	50000H
	Vibration	-	-	-	-
	Switch Cycle	-	100000	100000	100000
Other	Warranty	Years	5	5	5

## Technical Parameters

	Parameter	Unit	AQD-24-150-B-D	AQD-24-200-B-D
Output	Voltage	V	24	24
	Current	A	6.25 (Max)	8.3 (Max)
	Power	W	150	200
	Ripple & Noise (max)	mV	300	300
	Channel	-	1	1
	Voltage Tolerance	-	±5%	±5%
Input	Input Voltage	VAC	85-265	85-265
	Frequency	Hz	50/60	50/60
	Power Factor	-	>0.95	>0.95
	THD	-	<15%	<15%
	Standby Power	W	<1.5	<1.5
	Current	A	<1.65	<2.2
	Inrush Current	A	75	75
	Efficiency Full Load 110VAC	-	91%	91.5%
	Efficiency Full Load 230VAC	-	92%	93.5%
	Start 230VAC (milliseconds)	ms	<200	<200
	Rise Time 230VAC (milliseconds)	ms	<150	<150
	Hold Time 230VAC (milliseconds)	ms	>20	>20
Dimming	Protocol	-	DALI2	DALI2
	Output Frequency	Hz	4K	4K
	Dimming Ratio	-	1%-100%	1%-100%
	Dimming Compatibility	-	90%	90%
	Minimum output current	-	-	-
	Maximum output current	A	6.25	8.3
Protection	Short Circuit	-	Yes	Yes
	Over Voltage	-	Yes	Yes
	Over Load	-	Yes	Yes
Safety & EMC	Lighting Strike	KV	4	4
	Withstand Voltage	VAC	3750	3750
	Safety Standards	-	EN IEC 55015	EN IEC 55015
	EMC Emission EMC	-	EN IEC 61000-3-2	EN IEC 61000-3-2
	EMC immunity EMC	-	EN IEC61547	EN IEC61547
	Safety Approval Mark	-	SAA RCM	SAA RCM
Environment	Working Temperature	°C	-20-40	-20-40
	Storage Temperature	°C	-20-80	-20-80
	TC	°C	75	75
	Housing Material	-	Aluminum shell	Aluminum shell
	IP Rating	IP	IP67	IP67
	Lifetime	Hrs	50000H	50000H
	Vibration	-	-	-
	Switch Cycle	-	100000	100000
Other	Warranty	Years	5	5

## DALI Specifications

Parameter	Value
Version	2
Device Type	6
DALI Current Consumption	1.8 mA
Dimming Range	1%-100%
Dimming curve	Logarithmic (default), linear
Memory banks	0, 1, and private use for 2, 3, 4, 10, 11

## Standards and Compliance

Category	Reference / Standard
Electrical Safety (AU/NZ)	AS 61347.2.13:2018 & AS/NZS 61347.1:2016 (inc. Amd 1:2018, Amd 2:2025)
Electrical Safety (International)	IEC 61347-2-13:2014+AMD1:2016 used in conjunction with IEC 61347-1:2015+AMD1:2017
Certification Body	Global-Mark Electrical Product Safety Certification Scheme
Certificate Number	GMA-523921-EA
Test Report Number	GTS2025070108S01R2
Testing Laboratory	Global United Technology Services Co., Ltd.
Date of Issue	2025-12-12
Equipment Class	LED Control Gear (Electronic) - System 1 Approval

## Product Notes

- Measurement Conditions:** Unless otherwise specified, all parameters are measured at an input of **230 VAC**, rated load, and an ambient temperature of **25°C**.
- Ripple & Noise:** Measurement is performed at **20 MHz** bandwidth using a 12-inch twisted-pair cable terminated with **0.1  $\mu$ F** and **47  $\mu$ F** capacitors in parallel.
- Startup Time:** Startup time is measured from a **cold start**. Frequent power cycling (switching on and off) may increase the total startup time.
- EMC Compliance:** The driver is considered a component for installation into end-user equipment. Because Electromagnetic Compatibility (EMC) is affected by the entire assembly, the final equipment manufacturer must re-verify and confirm the EMC compliance of the complete system.

**Product Dimensions**

**AQD-24-030-B-D**

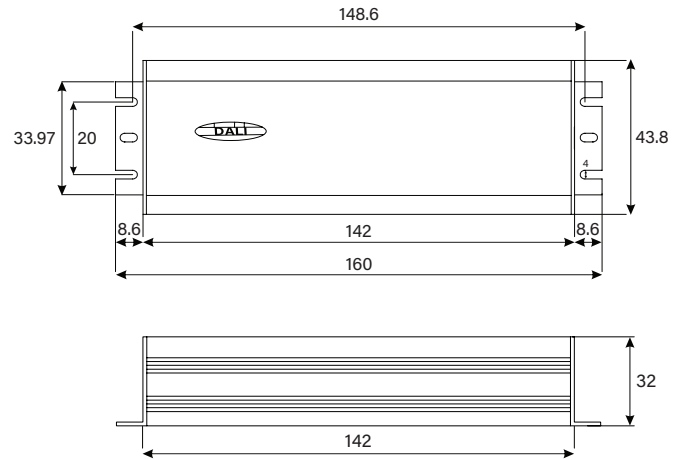

**AQD-24-060-B-D**

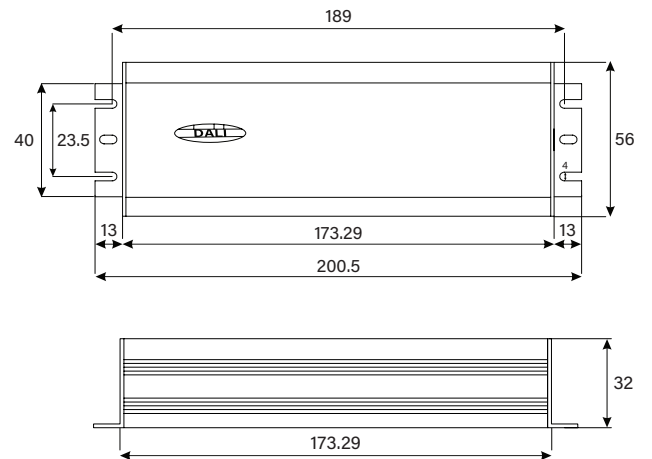

**AQD-24-100-B-D**

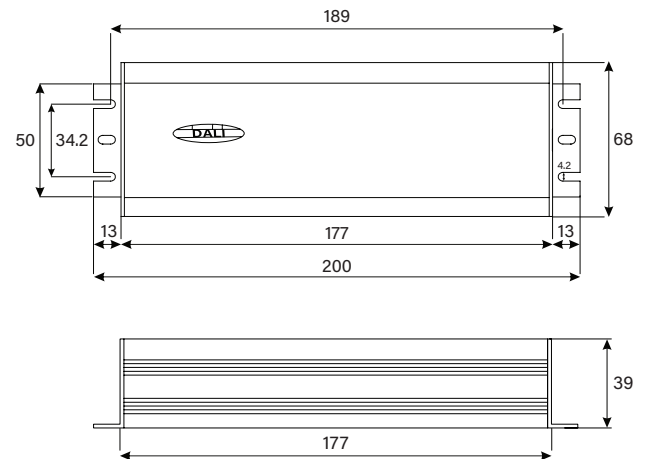

**AQD-24-150-B-D**

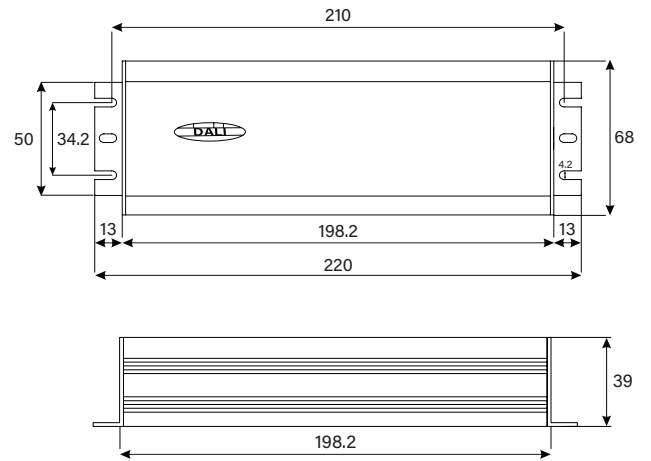

**AQD-24-200-B-D**

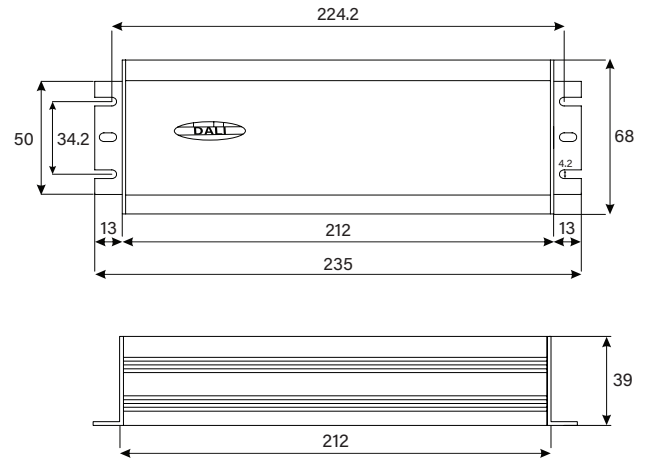

## Wiring Diagram

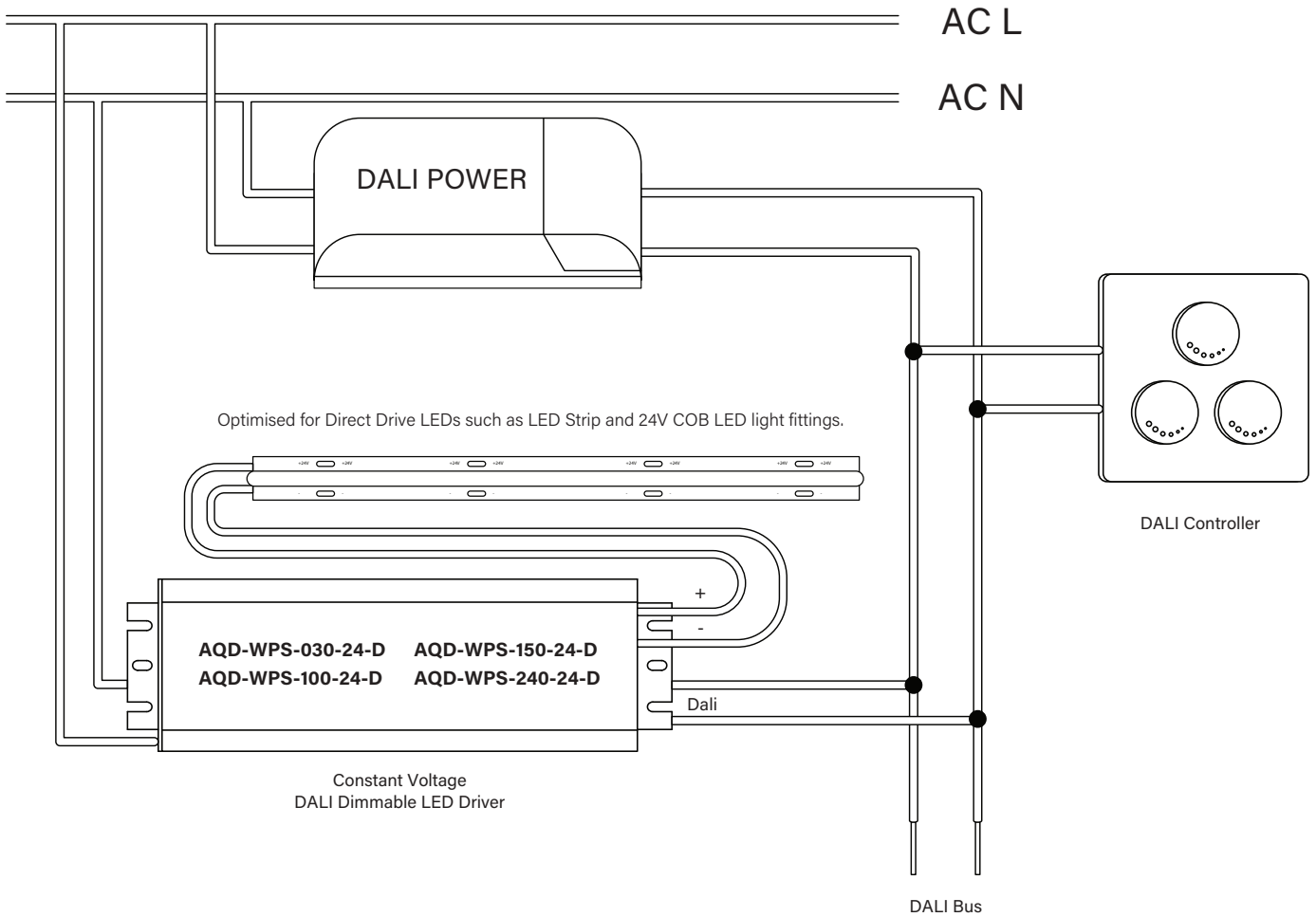

## Installation Guidelines

- **Inspection:** Do not operate the unit if the housing, input cables, or terminals show any signs of damage.
- **Factory Integrity:** Do not modify, cut, or extend any factory-installed input or output cables.
- **Polarity:** Ensure correct DC polarity when connecting the output to the load. Reverse polarity will cause immediate and permanent device failure.
- **Safety Sequence:** The AC input must be completely de-energized before connecting the lighting load to the power supply.
- **Thermal Management:** Ensure ample clearance and airflow around the unit to prevent overheating. Do not cover with insulation or building materials, and do not stack equipment on top of the housing. Obstructions may lead to thermal shutdown or permanent component failure.

**AQD-24-030-B-D**

**Electrical performance across whole input range.**

AGL test setup consisted of 5 units of 6W AGL-560. Meanwhile AQS test consisted of various AQS Strips totalling 30W output.

**AGL Efficiency**

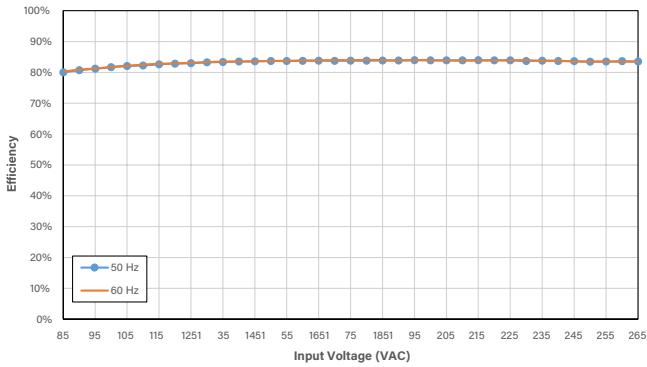

Power supply had >80% efficiency across whole input range.

**AQS Efficiency**

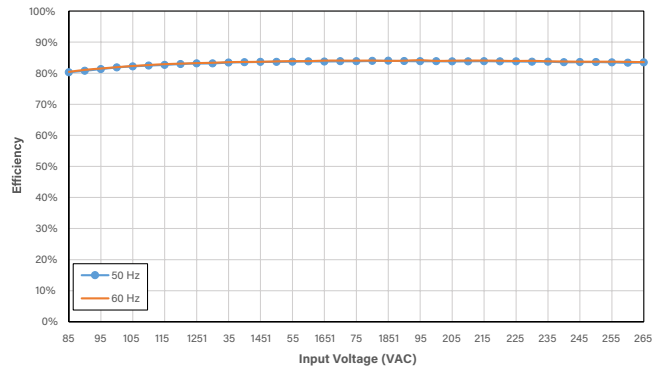

Power supply had >80% efficiency across whole input range.

**AGL Power Factor**

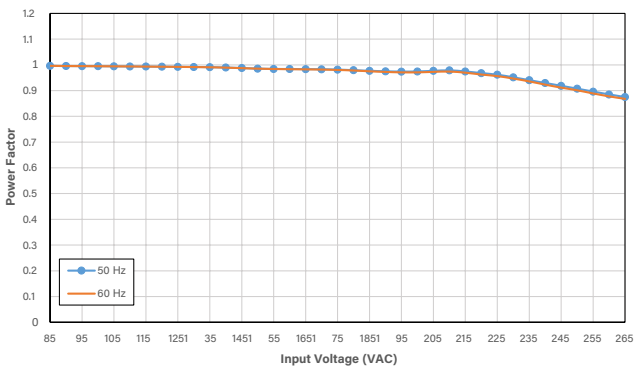

Power supply had >90 PF in full load for Australian use at 230VAC 50Hz.

**AQS Power Factor**

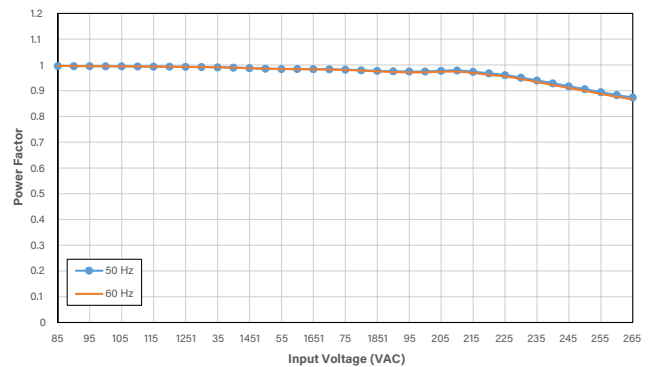

Power supply had >90 PF in full load for Australian use at 230VAC 50Hz.

**AGL Output Voltage**

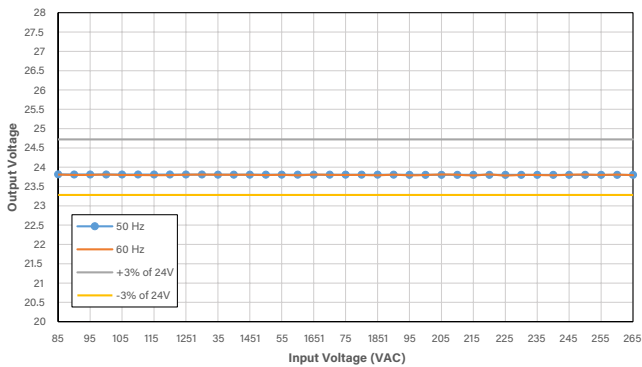

Power supply had maintained an output voltage of within +/- 3% of nominal 24V.

**AQS Output Voltage**

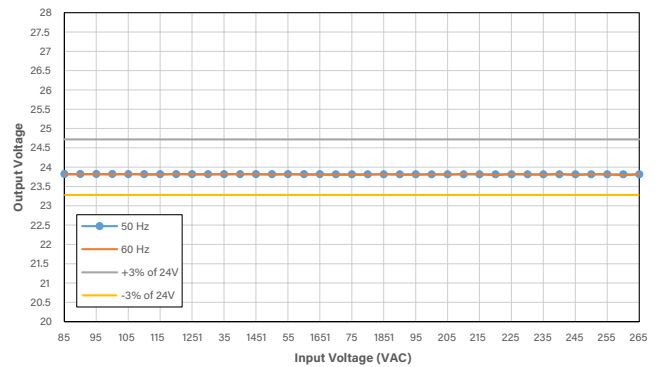

Power supply had maintained an output voltage of within +/- 3% of nominal 24V.



## Dimming performance across different load

Dimming test setup consisted of 1 - 6 units 6W AGL-560. AQD-24-030-B-D has an output of 4kHz 24V PWM. Test confirmed no flickering and shimmering from 0 to 100% dimming across 20% to 100% load.

AGL Dimming Curve vs Output Load at 50Hz

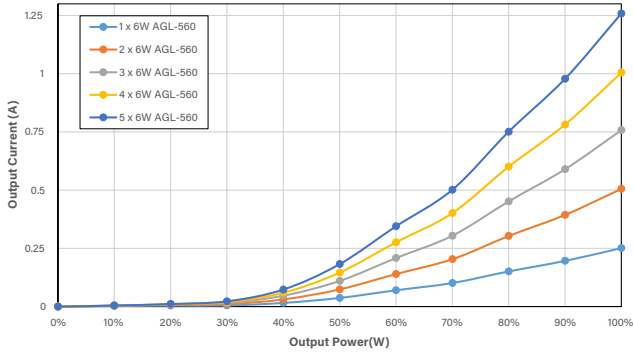

Test confirmed no flickering and shimmering from 0 to 100% on AGL-560 at 230VAC 50Hz input.

AGL Dimming Curve vs Output Load at 60Hz

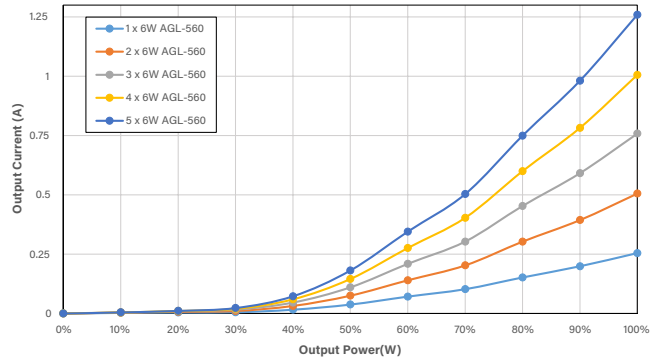

Test confirmed no flickering and shimmering from 0 to 100% on AGL-560 at 230VAC 60Hz input.

## Output Voltage at no load

Test confirmed that even at no load, AQD-24-030-B-D has maintained voltage regulation, +/-3% of 24V from 85VAC to 265VAC.

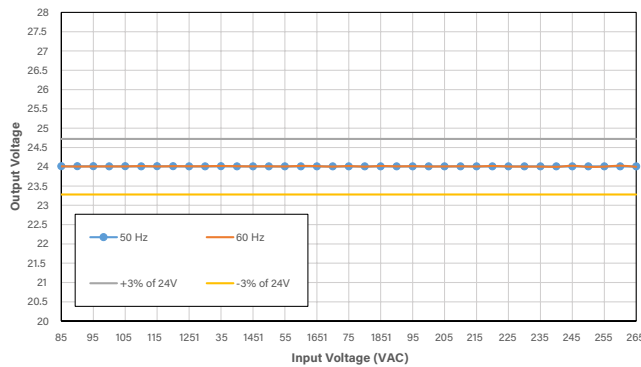

## AQD-24-060-B-D

### Electrical performance across whole input range.

AGL test setup consisted of 10 units of 6W AGL-560. Meanwhile AQS test consisted of various AQS Strips totalling 60W output.

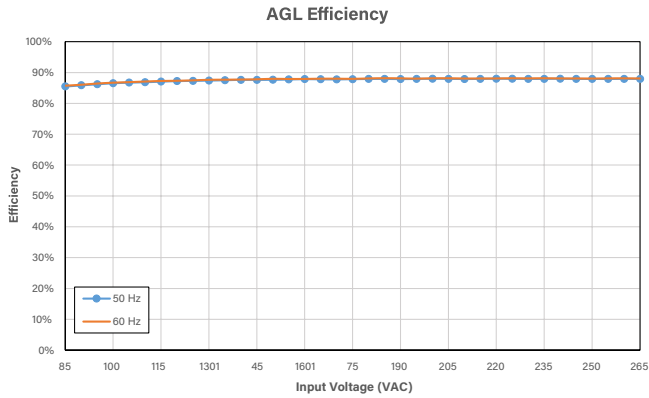

Power supply had >85% efficiency across whole input range.

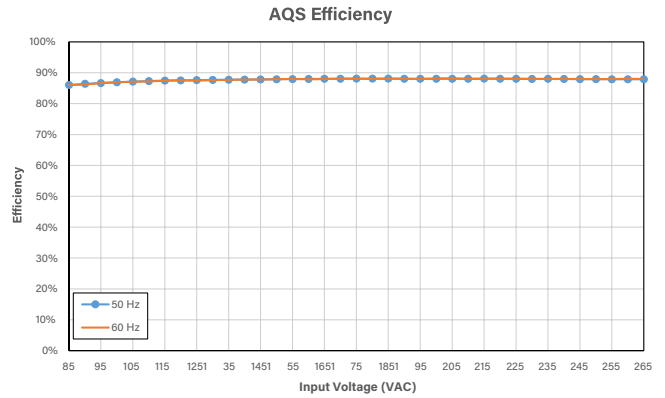

Power supply had >85% efficiency across whole input range.

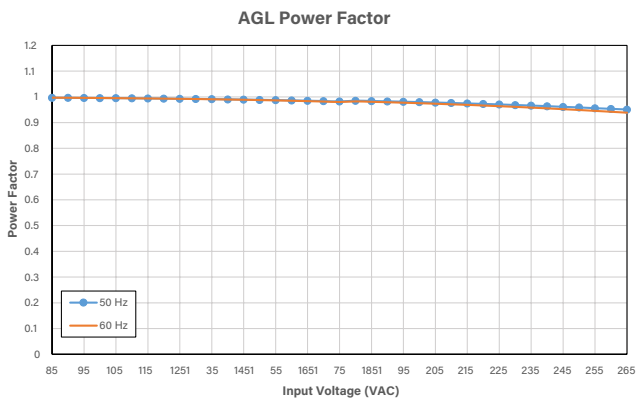

Power supply had >90 PF across whole input range.

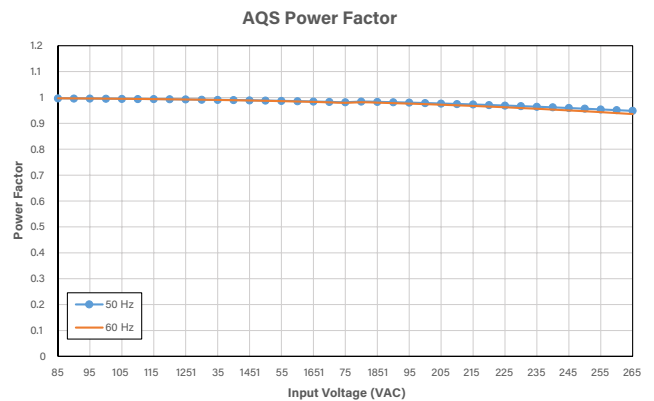

Power supply had >90 PF across whole input range.

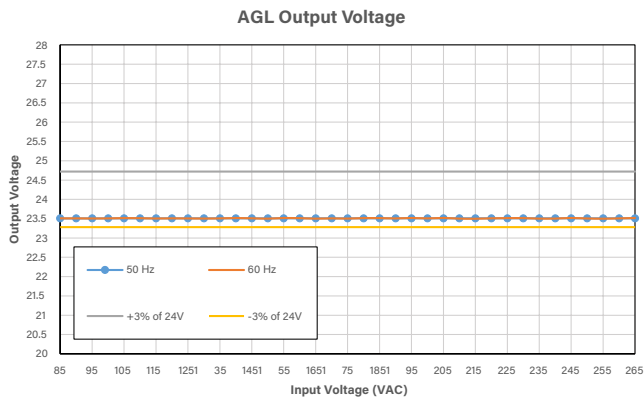

Power supply had maintained an output voltage of within +/- 3% of nominal 24V.

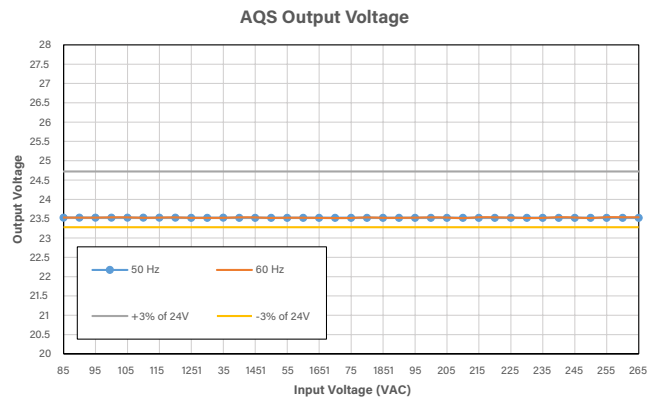

Power supply had maintained an output voltage of within +/- 3% of nominal 24V.

## Electrical performance across different loads

AGL test setup consisted of 10 units of 6W AGL-560. A QD-24-060-B-D can provide output current from 0A to the maximum 2.5A. Input of 230 VAC and 50Hz.

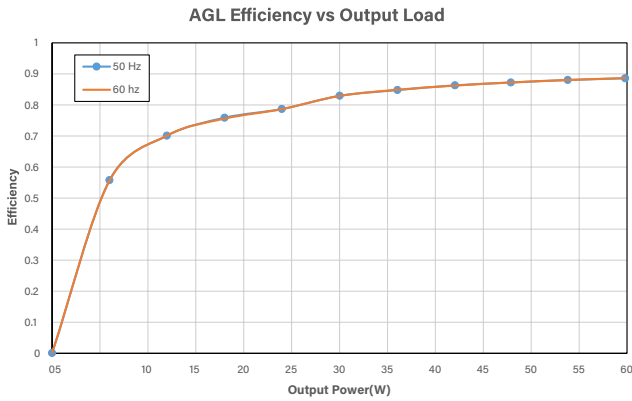

Power supply had achieved >70% efficiency for as low as 12W output load.

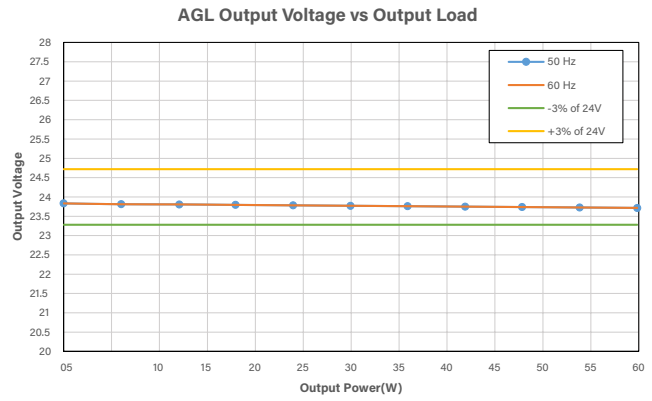

Power supply maintained within +/-3% of the nominal output 24V.

## Dimming performance at full load

Dimming test setup consisted of 10 units 6W AGL-560 and 60W of AQS units. A QD-24-060-B-D has an output of 4kHz 24V PWM. Input was set at 230VAC 50Hz. Dimmer used is DGLMIFU01 with RAPIX Addressing PC Software.

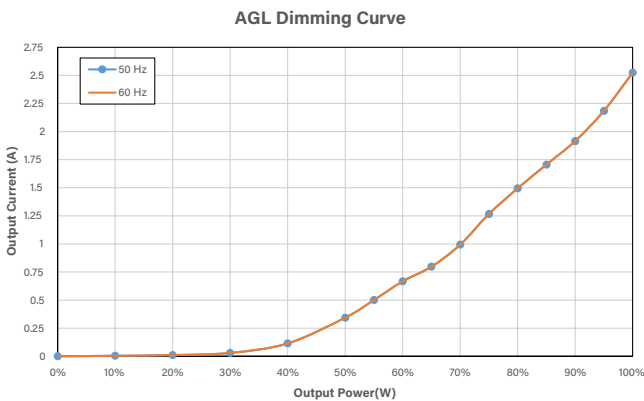

Test confirmed no flickering and shimmering from 0 to 100% on AGL-560

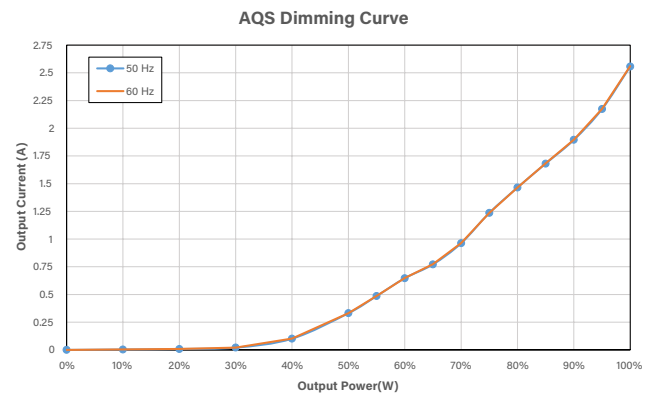

Test confirmed no flickering and shimmering from 0 to 100% on 30W AQS.

## Dimming performance across different load

Dimming test setup consisted of 1 - 10 units 6W AGL-560. AQD-24-060-B-D has an output of 4kHz 24V PWM. Test confirmed no flickering and shimmering from 0 to 100% dimming across 20% to 100% load.

AGL Dimming Curve vs Output Load at 50Hz

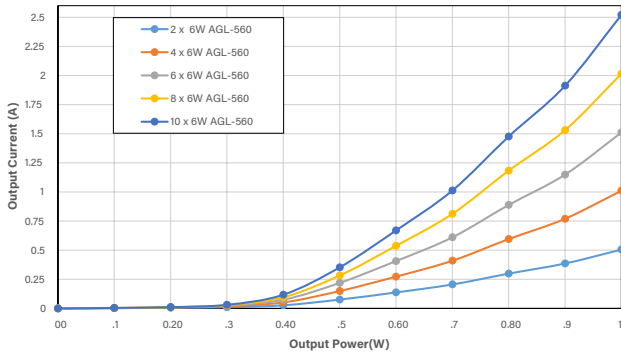

Test confirmed no flickering and shimmering from 0 to 100% on AGL-560 at 230VAC 50Hz input.

AGL Dimming Curve vs Output Load at 60Hz

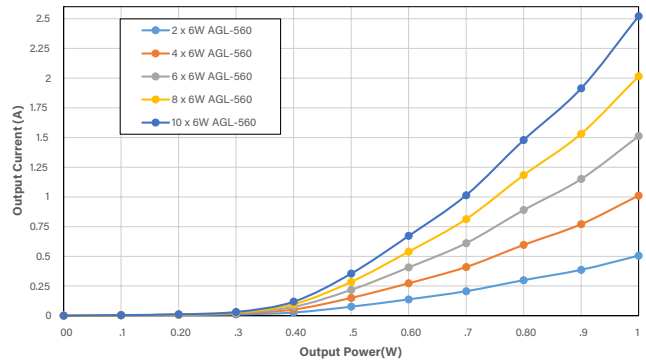

Test confirmed no flickering and shimmering from 0 to 100% on AGL-560 at 230VAC 60Hz input.

## Output Voltage at no load

Test confirmed that even at no load, AQD-24-060-B-D has maintained voltage regulation, +/-3% of 24V.

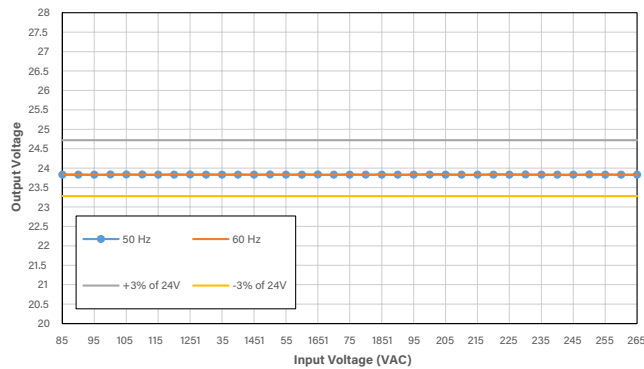

**AQD-24-100-B-D**

**Electrical performance across whole input range.**

AGL test setup consisted of 17 units of 6W AGL-560. Meanwhile AQS test consisted of various AQS Strips totalling 100W output.

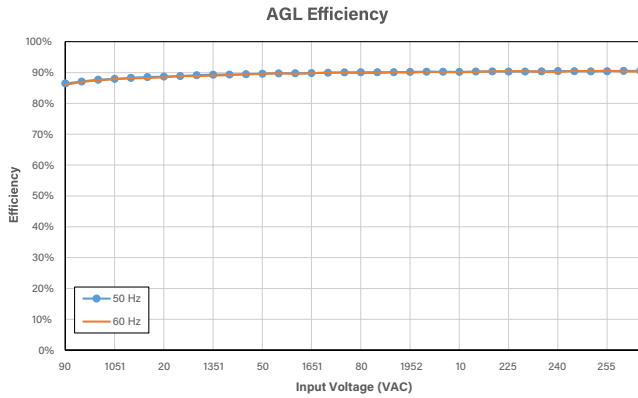

Power supply had >85% efficiency across whole input range.

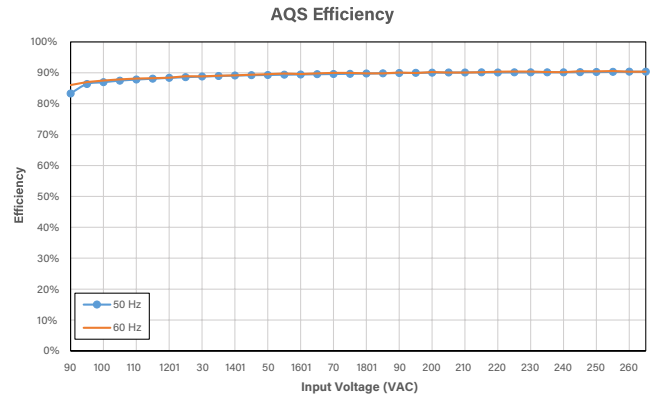

Power supply had >85% efficiency across whole input range.

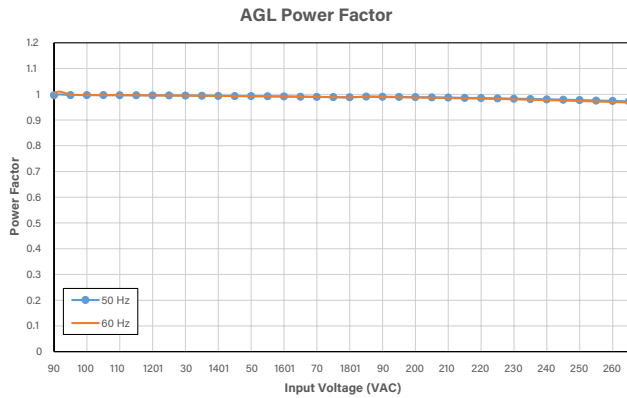

Power supply had >90 PF across whole input range.

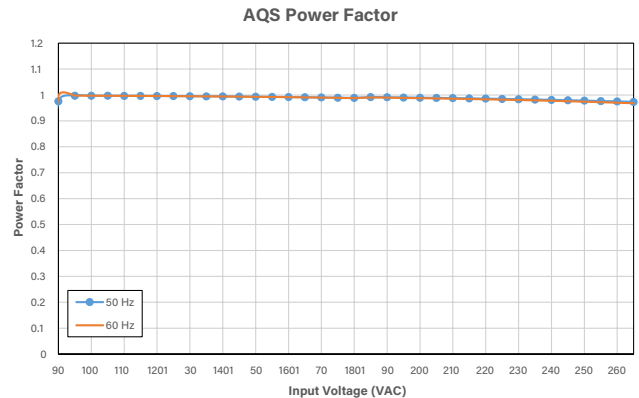

Power supply had >90 PF across whole input range.

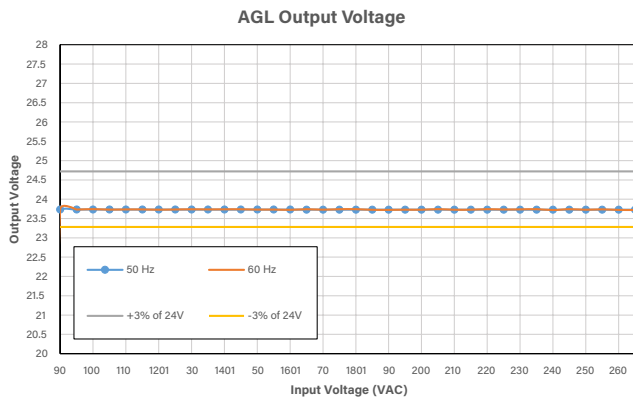

Power supply had maintained an output voltage of within +/- 3% of nominal 24V.

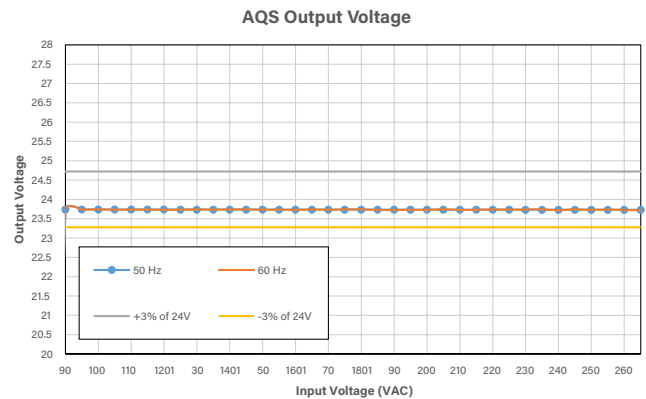

Power supply had maintained an output voltage of within +/- 3% of nominal 24V.

## Electrical performance across different loads

AGL test setup consisted of 17 units of 6W AGL-560. AGL-24-100-B-D can provide output current from 0A to the maximum 4.17A. Input of 230 VAC and 50Hz.

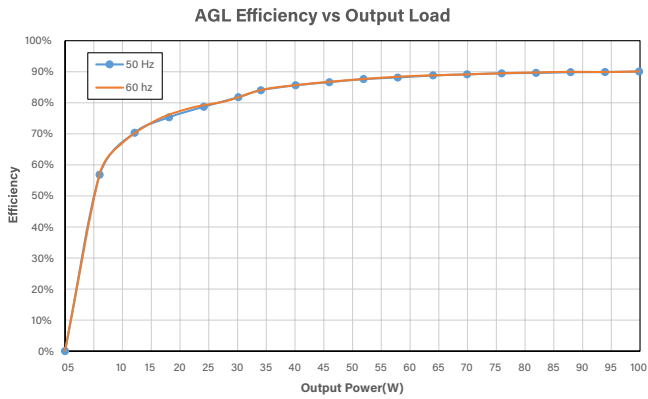

Power supply had achieved >70% efficiency for as low as 12W output load.

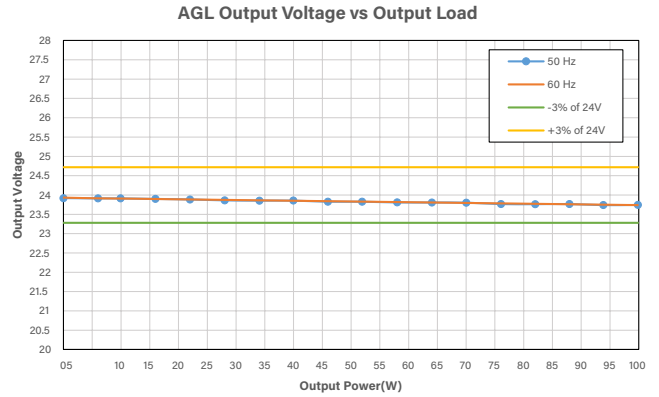

Power supply maintained within +/-3% of the nominal output 24V.

## Dimming performance at full load

Dimming test setup consisted of 17 units 6W AGL-560 and 100W of AQS units as output with 230VAC as input. AGL-24-100-B-D has an output of 4kHz 24V PWM.

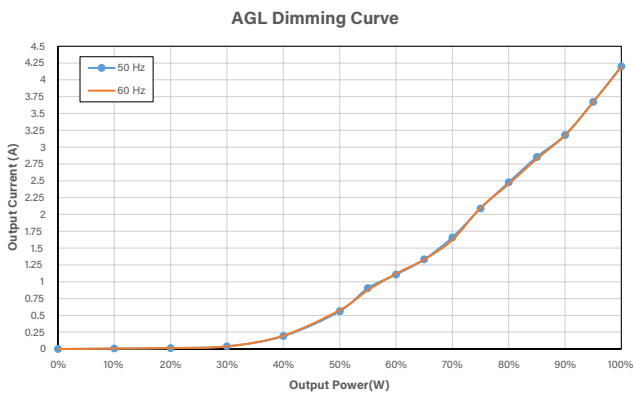

Test confirmed no flickering and shimmering from 0 to 100% on AGL-560

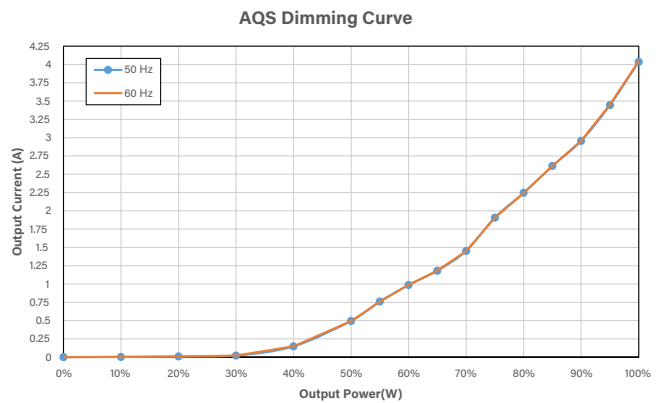

Test confirmed no flickering and shimmering from 0 to 100% on 100W AQS.

## Dimming performance across different load

Dimming test setup consisted of 1 - 10 units 6W AGL-560. AQD-24-100-B-D has an output of 4kHz 24V PWM. Test confirmed no flickering and shimmering from 0 to 100% dimming across 20% to 100% load.

AGL Dimming Curve vs Output Load at 50Hz

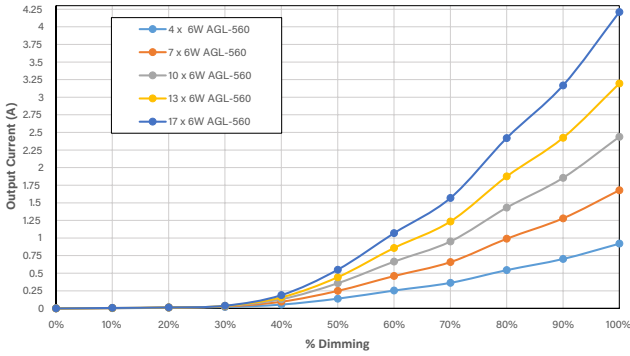

Test confirmed no flickering and shimmering from 0 to 100% on AGL-560 at 230VAC 50Hz input.

AGL Dimming Curve vs Output Load at 60Hz

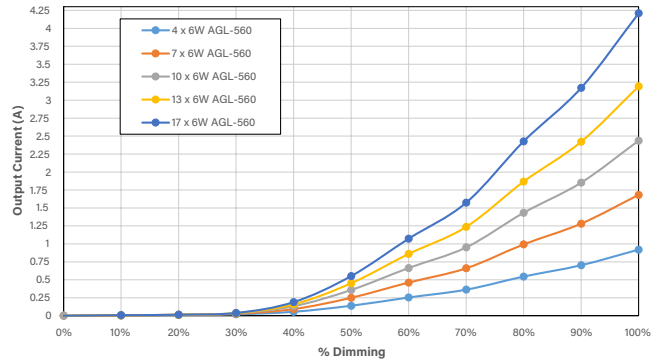

Test confirmed no flickering and shimmering from 0 to 100% on AGL-560 at 230VAC 60Hz input.

## Output Voltage at no load

Test confirmed that even at no load, AQD-24-100-B-D has maintained voltage regulation, +/-3% of 24V.

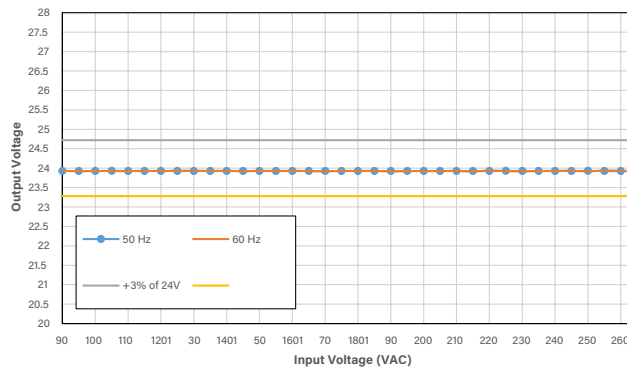

**AQD-24-150-B-D**

**Electrical performance across whole input range.**

AGL test setup consisted of 25 units of 6W AGL-560. Meanwhile AQS test consisted of various AQS Strips totalling 150W output.

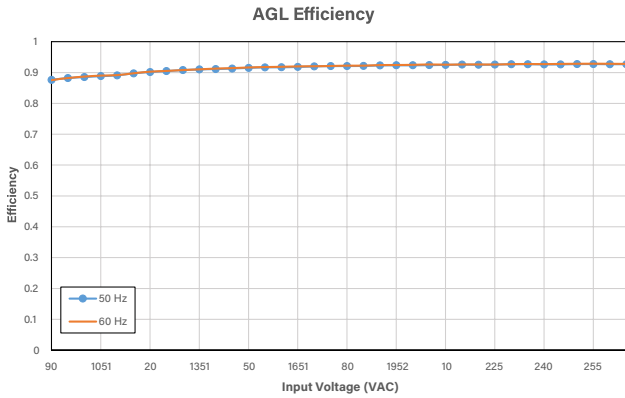

Power supply had >86% efficiency across whole input range.

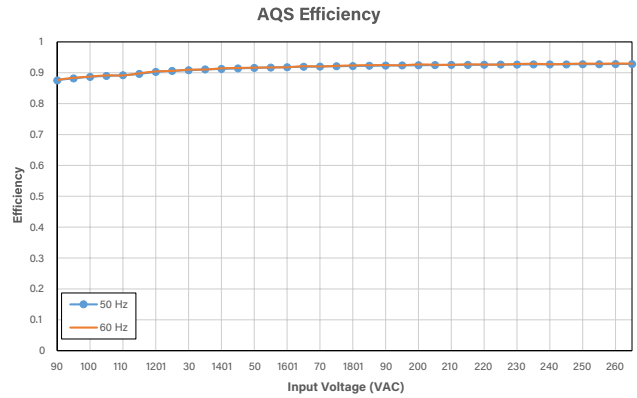

Power supply had >86% efficiency across whole input range.

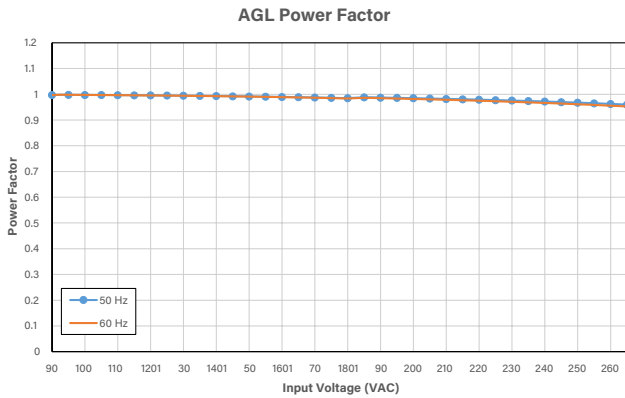

Power supply had >95 PF across whole input range.

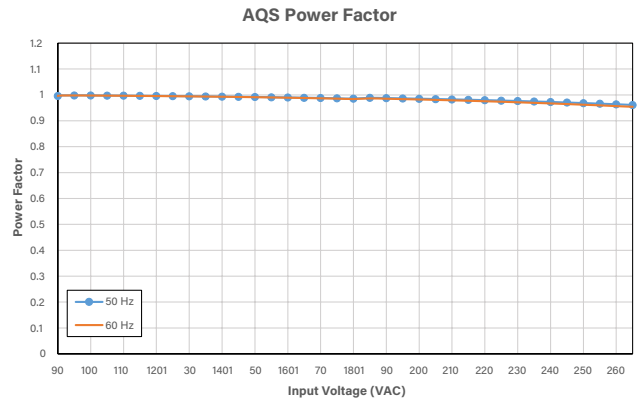

Power supply had >95 PF across whole input range.

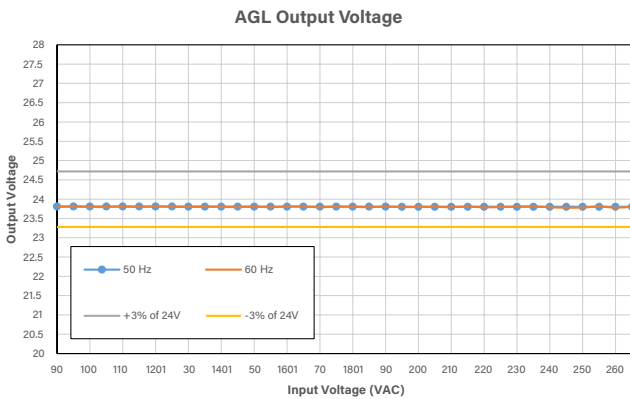

Power supply had maintained an output voltage of within +/- 3% of nominal 24V.

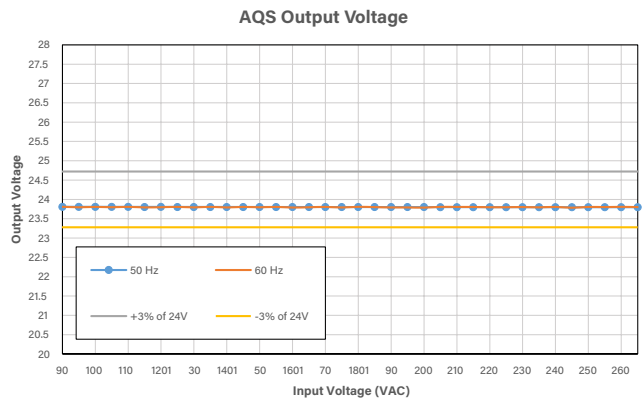

Power supply had maintained an output voltage of within +/- 3% of nominal 24V.

## Electrical performance across different loads

AGL test setup consisted of 25 units of 6W AGL-560. AQD-24-150-B-D can provide output current from 0A to the maximum 6.25A. Input of 230 VAC and 50Hz.

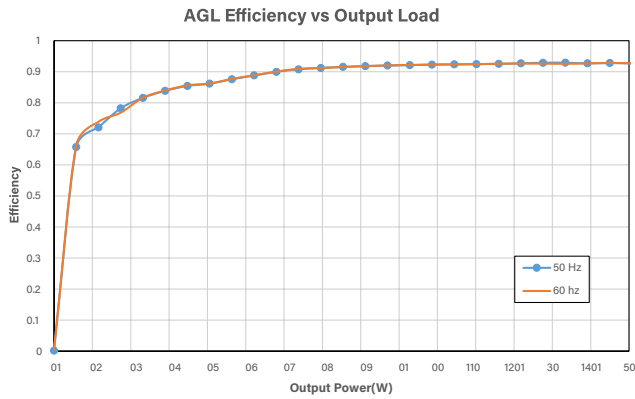

Power supply had achieved >70% efficiency for as low as 12W output load.

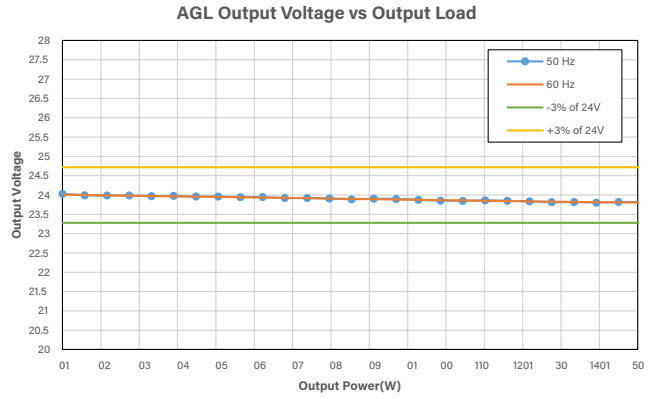

Power supply maintained within +/-3% of the nominal output 24V.

## Dimming performance at full load

Dimming test setup consisted of 25 units 6W AGL-560 and 150W of AQS units as output with 230VAC as input. AQD-24-150-B-D has an output of 4kHz 24V PWM.

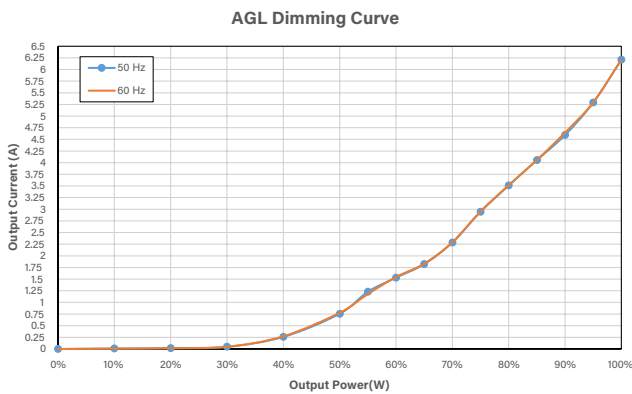

Test confirmed no flickering and shimmering from 0 to 100% on AGL-560

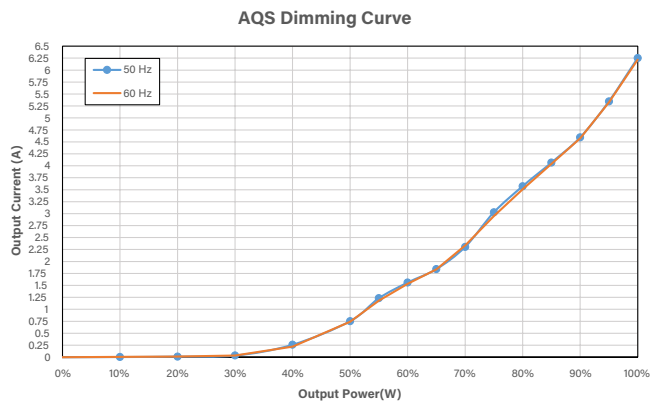

Test confirmed no flickering and shimmering from 0 to 100% on 150W AQS.

## Dimming performance across different load

Dimming test setup consisted of 1 - 25 units 6W AGL-560. AQD-24-060-B-D has an output of 4kHz 24V PWM. Test confirmed no flickering and shimmering from 0 to 100% dimming across 20% to 100% load.

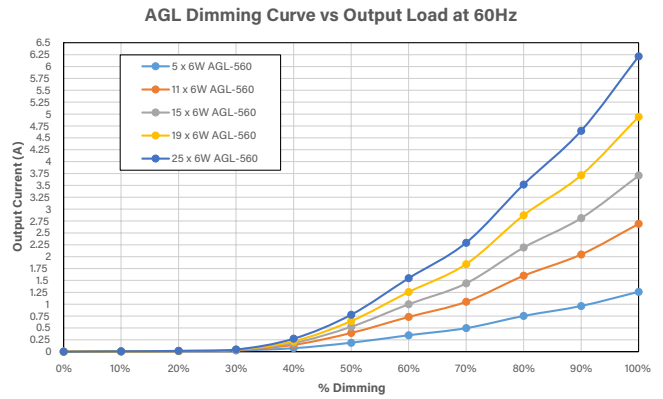
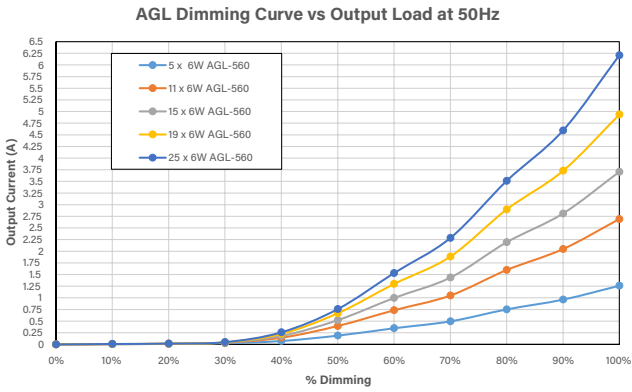

Test confirmed no flickering and shimmering from 0 to 100% on AGL-560 at 230VAC 50Hz input.

Test confirmed no flickering and shimmering from 0 to 100% on AGL-560 at 230VAC 60Hz input.

## Output Voltage at no load

Test confirmed that even at no load, AQD-24-150-B-D has maintained voltage regulation, +/-3% of 24V.

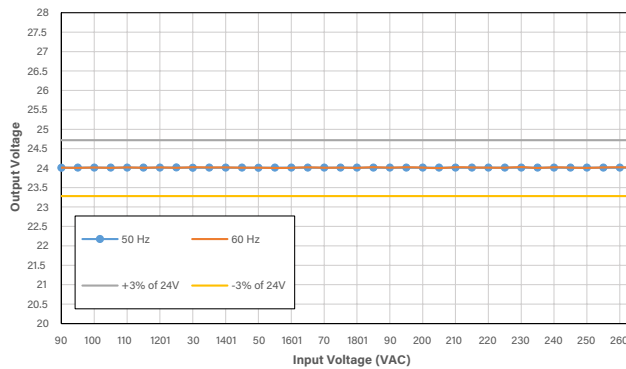

**AQD-24-200-B-D**

**Electrical performance across whole input range.**

AGL test setup set up consisted of a combination of 6W AGL-560 globes and AQS Strips totalling 200W.

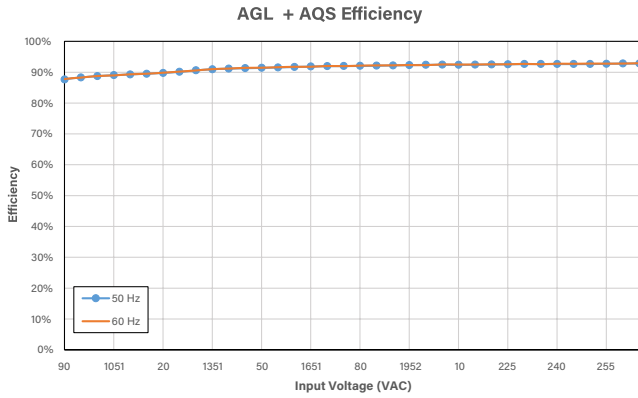

Power supply had >86% efficiency across whole input range.

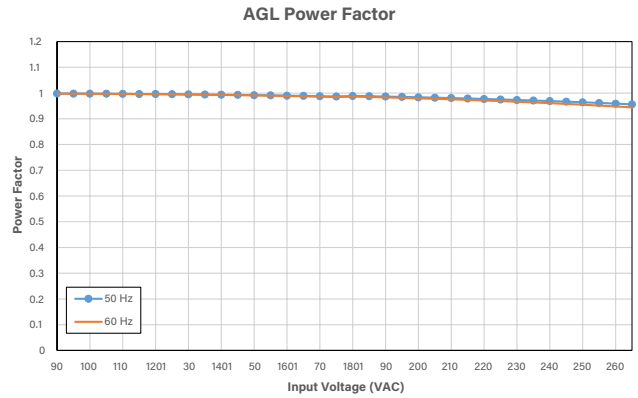

Power supply had >95 PF across whole input range.

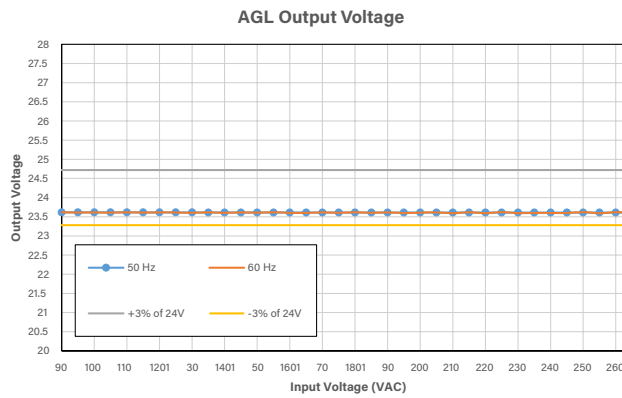

Power supply had maintained an output voltage of within +/- 3% of nominal 24V.

## Electrical performance across different loads and across different input voltages

AGL test setup consisted of a combination of 6W AGL-560 globes and AQS Strips totalling 200W. AQD-24-200-B-D can provide output current from 0A to the maximum 8.33A. Input of 230 VAC and 50Hz.

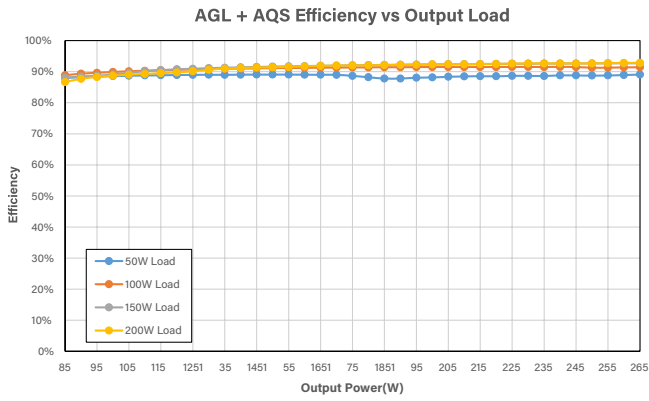

Even with 50W load, AQD-24-200-B-D has efficiency of greater than 88%. Input frequency is at 50 Hz.

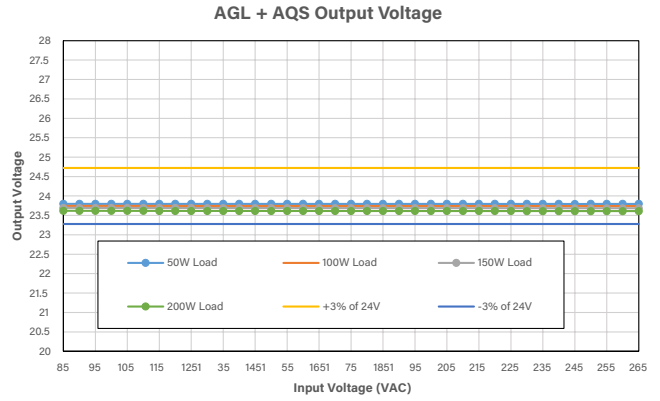

Power supply maintained within +/-3% of the nominal output 24V. Input frequency is at 50 Hz.

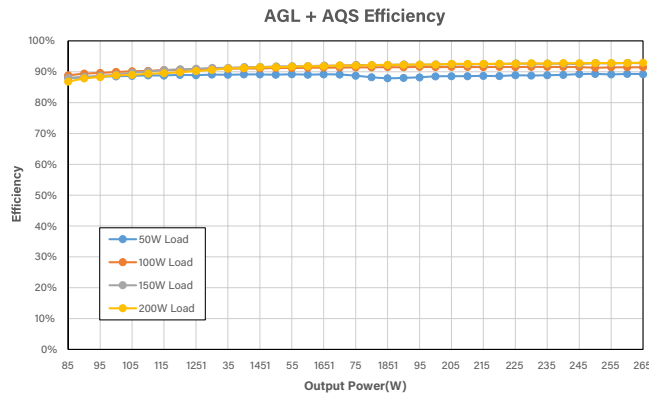

Even with 50W load, AQD-24-200-B-D has efficiency of greater than 88%. Input frequency is at 60 Hz.

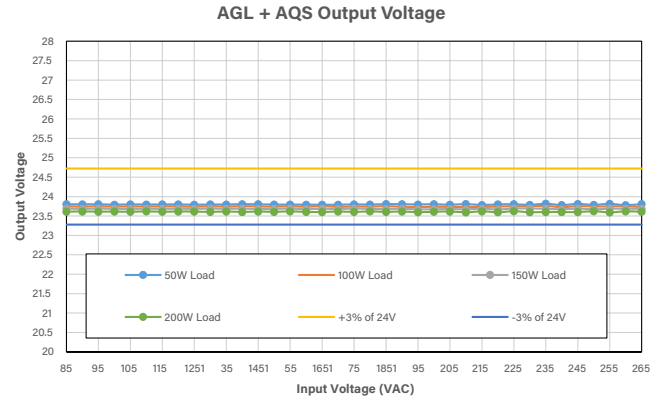

Power supply maintained within +/-3% of the nominal output 24V. Input frequency is at 60 Hz.

## Dimming performance at full load

Dimming test setup consisted of a combination of 6W AGL-560 globes and AQS Strips totalling 200W. AQD-24-200-B-D has an output of 4kHz 24V PWM. Test confirmed no flickering and shimmering from 0 to 100%.

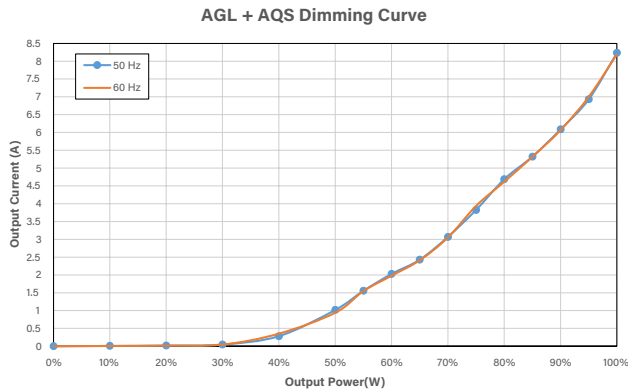

Test confirmed no flickering and shimmering from 0 to 100% on 200W output load.

## Dimming performance across different load

Dimming test setup consisted of a combination of 6W AGL-560 globes and AQS Strips totalling 200W. AQD-24-200-B-D has an output of 4kHz 24V PWM. Test confirmed no flickering and shimmering from 0 to 100%.

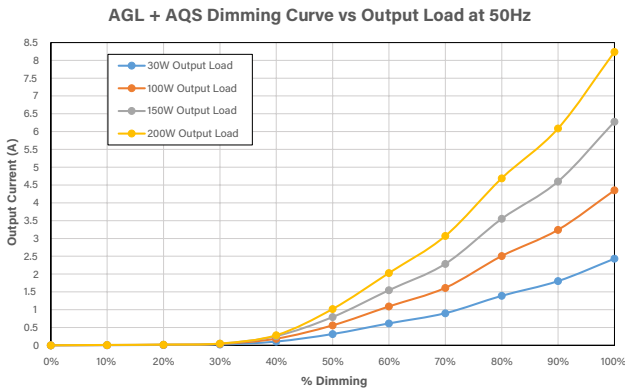

Test confirmed no flickering and shimmering from 0 to 100% dimming at 230VAC 50Hz input.

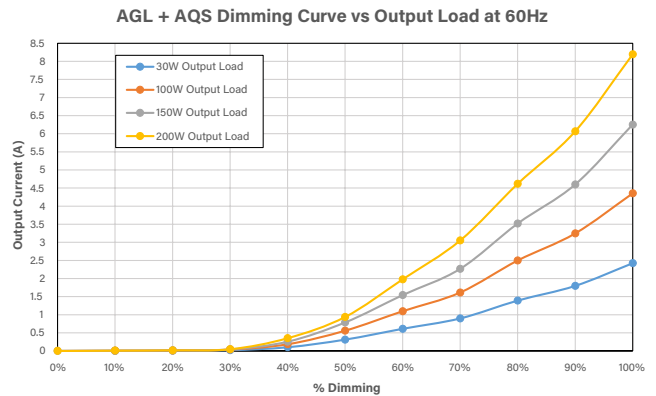

Test confirmed no flickering and shimmering from 0 to 100% dimming at 230VAC 60Hz input.

## Output Voltage at no load

Test confirmed that even at no load, AQD-24-200-B-D has maintained voltage regulation, +/-3% of 24V.

