

TRIAC IP20 Power Supplies

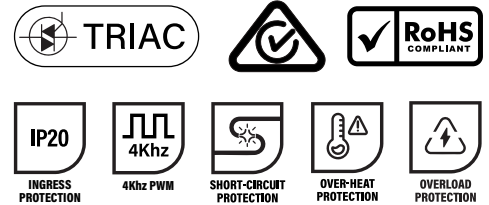

Features

- **Universal Input Voltage:** 100 – 265 VAC for global compatibility.
- **Safety First:** Fully isolated design ensures maximum operational safety.
- **Superior Dimming:** Smooth dimming performance with broad dimmer compatibility.
- **Universal Dimming:** Fully compatible with Leading Edge, Trailing Edge, and Universal phase-cut protocols. (Note: Tested for flicker-free performance with Clipsal, SAL, and Diginet systems).
- **Indoor Performance:** IP20 rated for standard indoor applications with a vented, finger-safe enclosure. (Note: Do not use in outdoor or damp settings).
- **Comprehensive Protection:** Built-in safeguards against short circuits, over-current, and over-voltage.
- **Certified Quality:** CE, TUV, ETL, and UL certified.
- **High Efficiency:** Features Active Power Factor Correction (PFC) for optimized energy use.
- **5-Year Warranty:** Long-term reliability guaranteed.

Warning: Optimised for Direct Drive LEDs such as LED Strip and 24V COB LED light fittings. Performance may vary if used with LEDs containing integrated driver circuits or capacitive loads.

Part Numbers

Code	Wattage
AQD-24-030-A-T	30W
AQD-24-060-A-T	60W
AQD-24-100-A-T	100W

Technical Parameters

	Parameter	Unit	AQD-24-030-A-T	AQD-24-060-A-T	AQD-24-100-A-T
Output	Voltage	V	24	24	24
	Current	A	1.25 (Max)	2.5 (Max)	4.15 (Max)
	Power	W	30	60	100
	Ripple & Noise (max)	mV	<400	<400	<400
	Channel	-	1	1	1
	Voltage Tolerance	-	±5%	±5%	±5%
Input	Input Voltage	VAC	100-265	100-265	100-265
	Frequency	Hz	50/60	50/60	50/60
	Power Factor	-	>0.9	>0.9	>0.9
	THD	-	<15%	<15%	<15%
	Standby Power	W	<3.5	<3.5	<3.5
	Current	A	<0.38	<0.7	<1.2
	Inrush Current (Full Output Load)	A	13.84	14.37	11.09
	Pulse Duration (T50)	S	133	230	183
	Efficiency Full Load 110VAC	-	80%	87%	87%
	Efficiency Full Load 230VAC	-	82%	89%	90%
	Start 230VAC (milliseconds)	ms	<1500	<1500	<1500
	Rise Time 230VAC (milliseconds)	ms	<1500	<1500	<1500
	Hold Time 230VAC (milliseconds)	ms	>20	>20	>20
Dimming	Protocol	-	Triac	Triac	Triac
	Output Frequency	Hz	4K	4K	4K
	Dimming Ratio	-	0.05%-100%	0.05%-100%	0.05%-100%
	Dimming Compatibility	-	90%	90%	90%
	Minimum output current	-	-	-	-
	Maximum output current	A	1.25	2.5	4.15
Protection	Short Circuit	-	Yes	Yes	Yes
	Over Voltage	-	Yes	Yes	Yes
	Over Load	-	Yes	Yes	Yes
Safety & EMC	Lighting Strike	KV	1.5	1.5	1.5
	Withstand Voltage	VAC	3750	3750	3750
	Safety Standards	-	EN IEC 55015	EN IEC 55015	EN IEC 55015
	EMC Emission EMC	-	EN IEC 61000-3-2	EN IEC 61000-3-2	EN IEC 61000-3-2
	EMC immunity EMC	-	EN IEC61547	EN IEC61547	EN IEC61547
	Safety Approval Mark	-	SAA RCM	SAA RCM	SAA RCM
Environment	Working Temperature	°C	-20-40	-20-40	-20-40
	Storage Temperature	°C	-20-80	-20-80	-20-80
	TC	°C	75	75	75
	Housing Material	-	PC	PC	PC
	IP Rating	IP	IP20	IP20	IP20
	Lifetime	Hrs	50000H	50000H	50000H
	Vibration	-	-	-	-
	Switch Cycle	-	>100000	100000	100000
Other	Warranty	Years	5	5	5

Standards and Compliance

Category	Reference / Standard
Electrical Safety (AU/NZ)	AS 61347.2.13:2018 & AS/NZS 61347.1:2016 (inc. Amd 1:2018, Amd 2:2025)
Electrical Safety (International)	IEC 61347-2-13:2014+AMD1:2016 used in conjunction with IEC 61347-1:2015+AMD1:2017
Certification Body	Global-Mark Electrical Product Safety Certification Scheme
Certificate Number	GMA-526178-EA
Test Report Number	GTS2025090507S01R2, GTS2025090507E01
Testing Laboratory	Global United Technology Services Co., Ltd.
Date of Issue	2025-10-10
Equipment Class	LED Driver

Recommended Output Quantity Combination

	AQD-24-030-B-T	AQD-24-060-B-T	AQD-24-100-B-T
AGL-560 E- Version (Dimmable)	5	10	17

Product Notes

- Measurement Conditions:** Unless otherwise specified, all parameters are measured at an input of **230 VAC**, rated load, and an ambient temperature of **25°C**.
- Ripple & Noise:** Measurement is performed at **20 MHz** bandwidth using a 12-inch twisted-pair cable terminated with **0.1 uF** and **47 uF** capacitors in parallel.
- Startup Time:** Startup time is measured from a **cold start**. Frequent power cycling (switching on and off) may increase the total startup time.
- EMC Compliance:** The driver is considered a component for installation into end-user equipment. Because Electromagnetic Compatibility (EMC) is affected by the entire assembly, the final equipment manufacturer must re-verify and confirm the EMC compliance of the complete system.

Product Dimensions

AQD-24-030-A-T

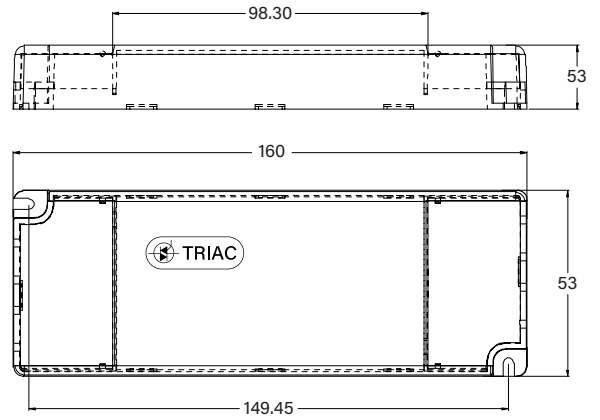

AQD-24-060-A-T

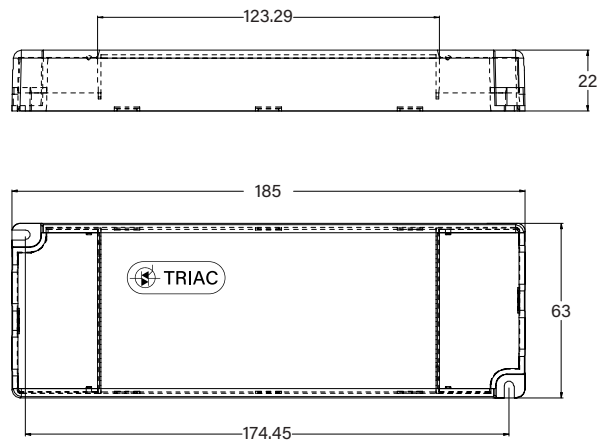

AQD-24-100-A-T

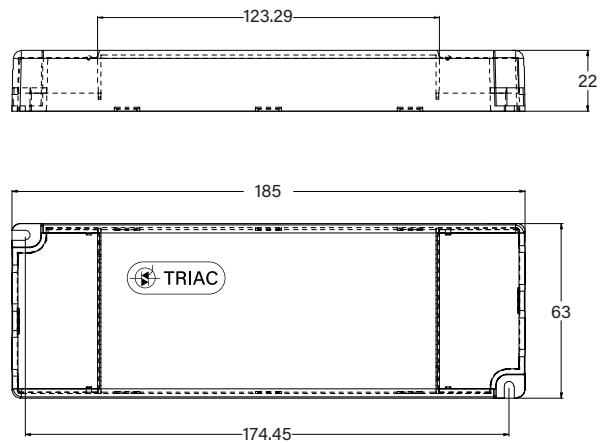

Wiring Diagram

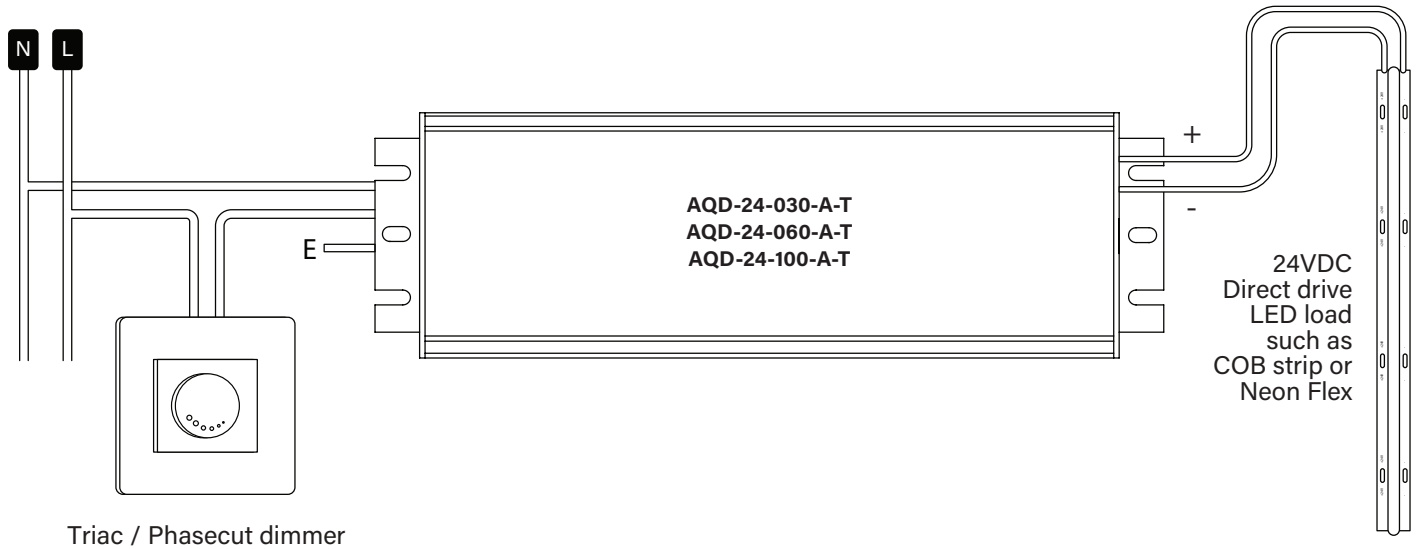

Installation Guidelines

- **Inspection:** Do not operate the unit if the housing, input cables, or terminals show any signs of damage.
- **Factory Integrity:** Do not modify, cut, or extend any factory-installed input or output cables.
- **Polarity:** Ensure correct DC polarity when connecting the output to the load. Reverse polarity will cause immediate and permanent device failure.
- **Safety Sequence:** The AC input must be completely de-energized before connecting the lighting load to the power supply.
- **Thermal Management:** Ensure ample clearance and airflow around the unit to prevent overheating. Do not cover with insulation or building materials, and do not stack equipment on top of the housing. Obstructions may lead to thermal shutdown or permanent component failure.
- **Load Optimization:** Maintain a maximum of 80% output load to accommodate the high inrush current typical of LED lights with internal drivers. Note that increased cable distance between the power supply and the load may further amplify inrush effects; ensure cable gauges are appropriately sized.

AQD-24-030-A-T

Compatible Dimmers

Aqualux has tested the following dimmers to be compatible with AQD-24-030-A-T.

Model NO.	Brand	Voltage	Frequency	Min Load	Max Load	Performance Rating
6032B	Deta	230-240V	50Hz	3W	200W	Best
32E450UDM	Clipsal	220-240V	50Hz	10W	450W	Better
32E450LM	Clipsal	220-240V	50Hz	-	450W	Go
SDA450U	SAL	220-240V	50Hz	2W	400W	Better
MEDM	Diginet	220-240V	50Hz	2W	400W	Best
MMDM/RT	Diginet	220-240V	50Hz	1W	400W	Better

Dimming Performance

AQD-24-030-A-T has shown no flickering and shimmering in both tests of 5 x 6W dimmable AGL-560 and AQS units totalling 30W.

	Minimum Output Current (A)	Maximum Output Current (A)	Shimmering	Flickering
Diginet MEDM	0	1.25	None	None
Clipsal 32E450UDM	0.14	1.25	None	None
SAL SDA450U	0	1.25	None	None
Clipsal 32E450LM	0.03	1.25	None	None
Diginet MMDM/RT	0	1.25	None	None
DETA 6032B	0	1.25	None	None

Electrical Performance

AGL test setup consisted of 5 units of 6W dimmable AGL-560. Meanwhile AQS test consisted of various AQS Strips totalling 30W output.

AGL Efficiency

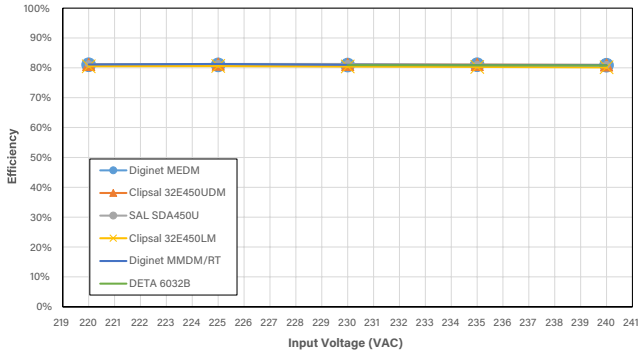

Power supply had $\geq 80\%$ efficiency across whole input range.

AQS Efficiency

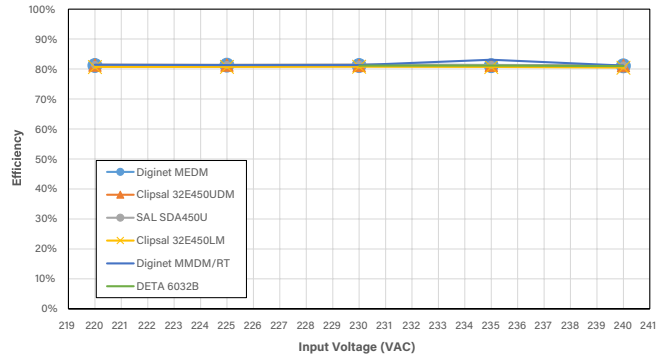

Power supply had $\geq 80\%$ efficiency across whole input range.

AGL Power Factor

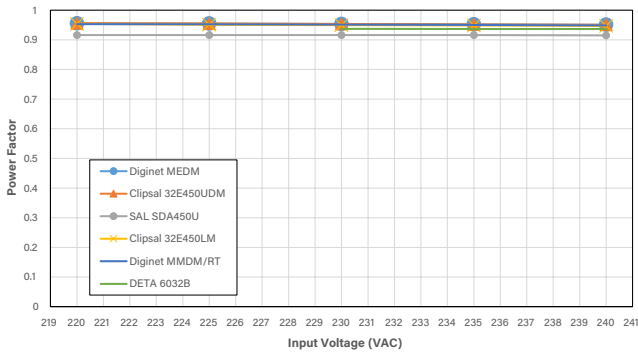

Power supply had > 90 PF in full load for Australian use at 230VAC 50Hz.

AQS Power Factor

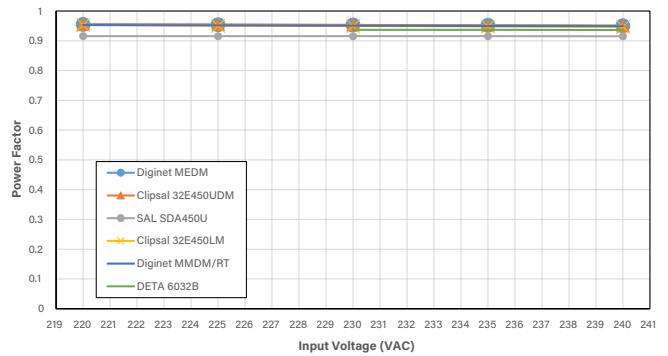

Power supply had > 90 PF in full load for Australian use at 230VAC 50Hz.

AGL Voltage Output

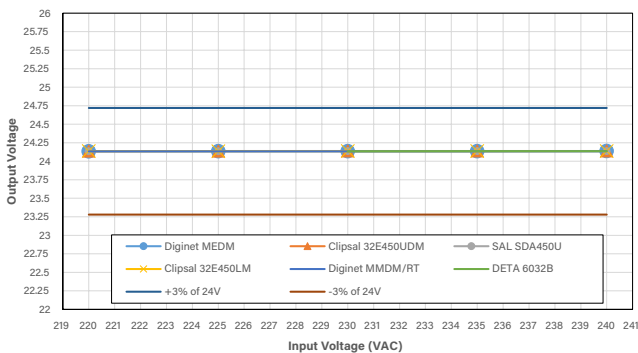

Power supply had maintained an output voltage of within $\pm 3\%$ of nominal 24V.

AQS Voltage Output

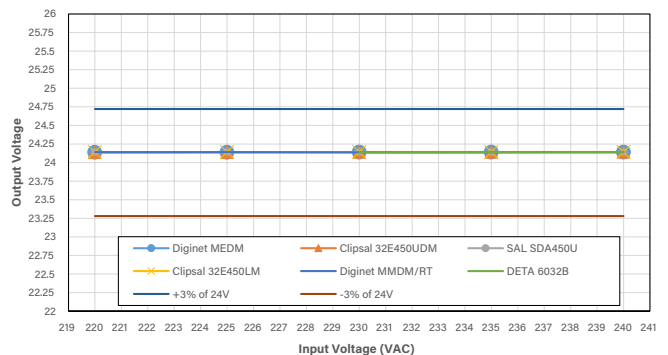

Power supply had maintained an output voltage of within $\pm 3\%$ of nominal 24V.

AQD-24-060-A-T

Compatible Dimmers

Aqualux has tested the following dimmers to be compatible with AQD-24-060-A-T.

Model NO.	Brand	Voltage	Frequency	Min Load	Max Load	Performance Rating
6032B	Deta	230-240V	50Hz	3W	200W	Best
32E450UDM	Clipsal	220-240V	50Hz	10W	450W	Better
32E450LM	Clipsal	220-240V	50Hz	-	450W	Go
SDA450U	SAL	220-240V	50Hz	2W	400W	Better
MEDM	Diginet	220-240V	50Hz	2W	400W	Best
MMDM/RT	Diginet	220-240V	50Hz	1W	400W	Better

Dimming Performance

AQD-24-060-A-T has proven no flickering and shimmering in both tests of 10 x 6W AGL-560 and AQS units totalling 60W.

	Minimum Output Current (A)	Maximum Output Current (A)	Shimmering	Flickering
Diginet MEDM	0	1.25	None	None
Clipsal 32E450UDM	0.23	1.25	None	None
SAL SDA450U	0	1.25	None	None
Clipsal 32E450LM	0.15	1.25	None	None
Diginet MMDM/RT	0	1.25	None	None
DETA 6032B	0	1.25	None	None

Electrical Performance

AGL test setup consisted of 10 units of 6W dimmable AGL-560. Meanwhile AQS test consisted of various AQS Strips totalling 60W output.

AGL Efficiency

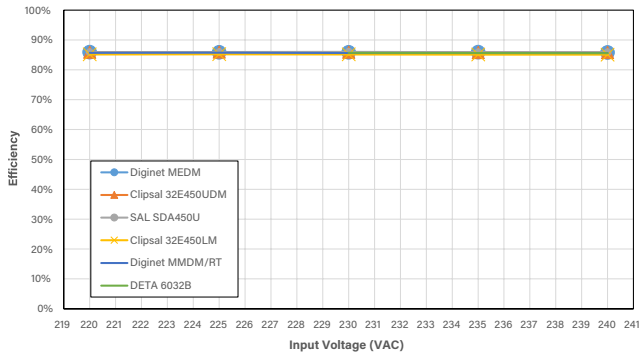

Power supply had $\geq 85\%$ efficiency across whole input range.

AQS Efficiency

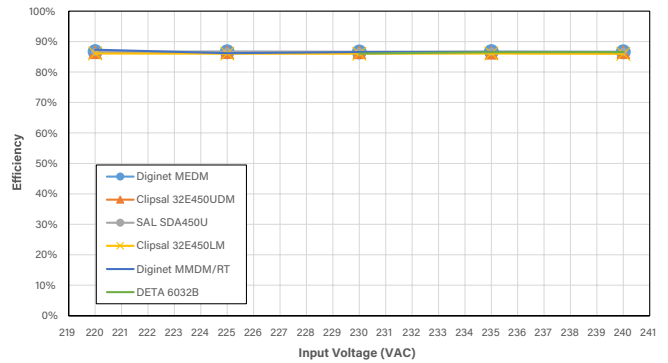

Power supply had $\geq 85\%$ efficiency across whole input range.

AGL Power Factor

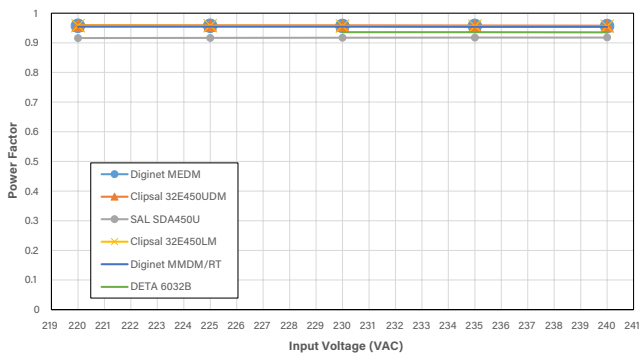

Power supply had > 90 PF in full load for Australian use at 230VAC 50Hz.

AQS Power Factor

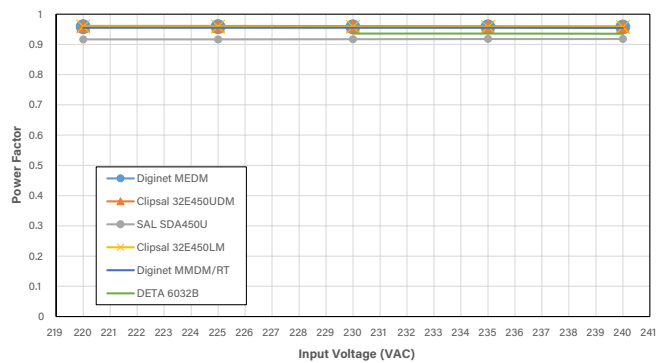

Power supply had > 90 PF in full load for Australian use at 230VAC 50Hz.

AGL Voltage Output

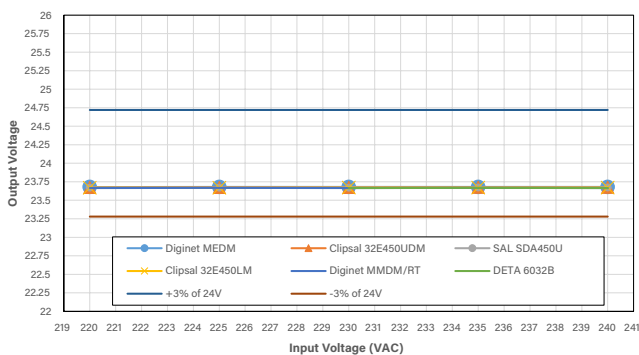

Power supply had maintained an output voltage of within $\pm 3\%$ of nominal 24V.

AQS Voltage Output

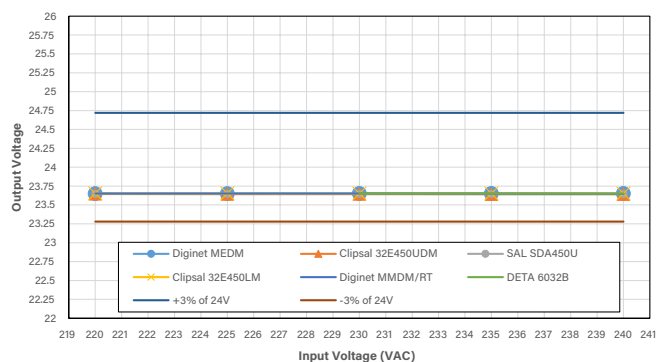

Power supply had maintained an output voltage of within $\pm 3\%$ of nominal 24V.

AQD-24-100-A-T

Compatible Dimmers

Aqualux has tested the following dimmers to be compatible with AQD-24-100-A-T.

Model NO.	Brand	Voltage	Frequency	Min Load	Max Load	Performance Rating
6032B	Deta	230-240V	50Hz	3W	200W	Best
32E450UDM	Clipsal	220-240V	50Hz	10W	450W	Better
32E450LM	Clipsal	220-240V	50Hz	-	450W	Go
SDA450U	SAL	220-240V	50Hz	2W	400W	Better
MEDM	Diginet	220-240V	50Hz	2W	400W	Best
MMDM/RT	Diginet	220-240V	50Hz	1W	400W	Better

Dimming Performance

AQD-24-100-A-T has proven no flickering and shimmering in both tests of 17 x 6W dimmable AGL-560 and AQS units totalling 100W.

	Minimum Output Current (A)	Maximum Output Current (A)	Shimmering	Flickering
Diginet MEDM	0	1.25	None	None
Clipsal 32E450UDM	0.29	1.25	None	None
SAL SDA450U	0	1.25	None	None
Clipsal 32E450LM	0.14	1.25	None	None
Diginet MMDM/RT	0	1.25	None	None
DETA 6032B	0	1.25	None	None

Electrical Performance

AGL test setup consisted of 17 units of 6W AGL-560. Meanwhile AQS test consisted of various AQS Strips totalling 100W output.

AGL Efficiency

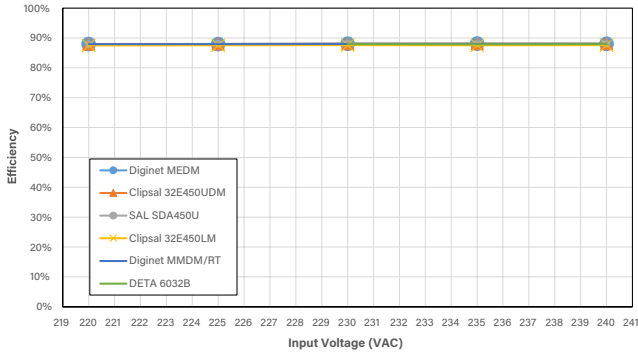

Power supply had $\geq 86\%$ efficiency across whole input range.

AQS Efficiency

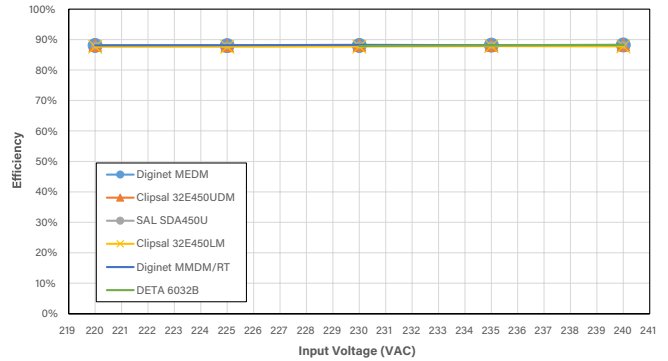

Power supply had $\geq 86\%$ efficiency across whole input range.

AGL Power Factor

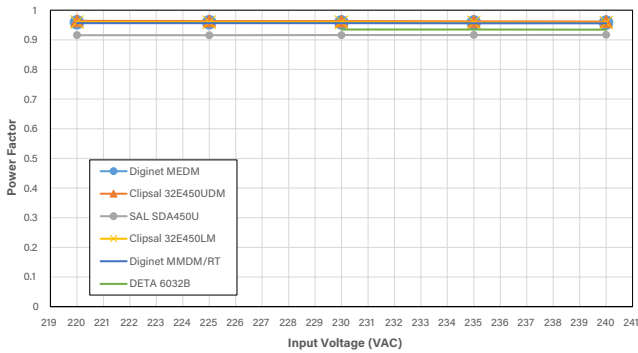

Power supply had >90 PF in full load for Australian use at 230VAC 50Hz.

AQS Power Factor

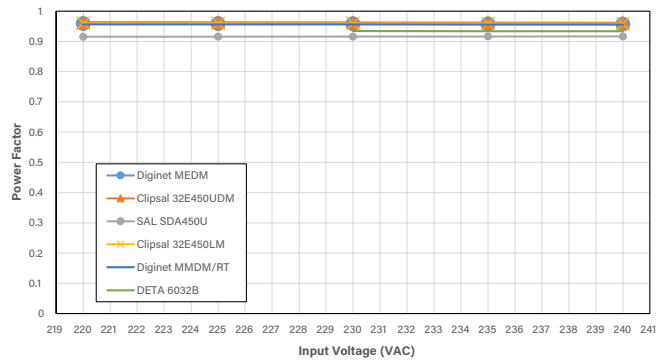

Power supply had >90 PF in full load for Australian use at 230VAC 50Hz.

AGL Voltage Output

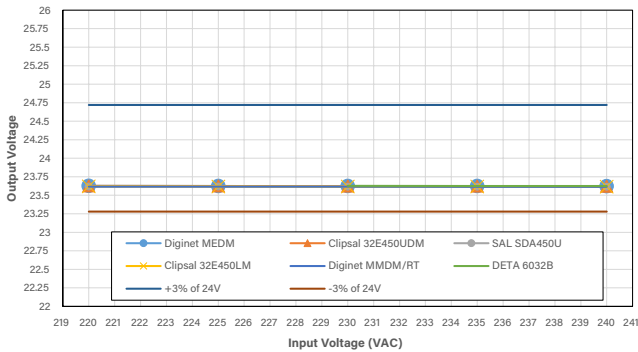

Power supply had maintained an output voltage of within $\pm 3\%$ of nominal 24V.

AQS Voltage Output

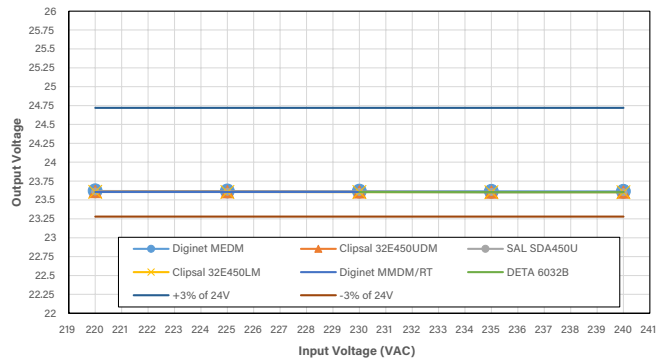

Power supply had maintained an output voltage of within $\pm 3\%$ of nominal 24V.