

RADAM 8 PENDANT LIGHT

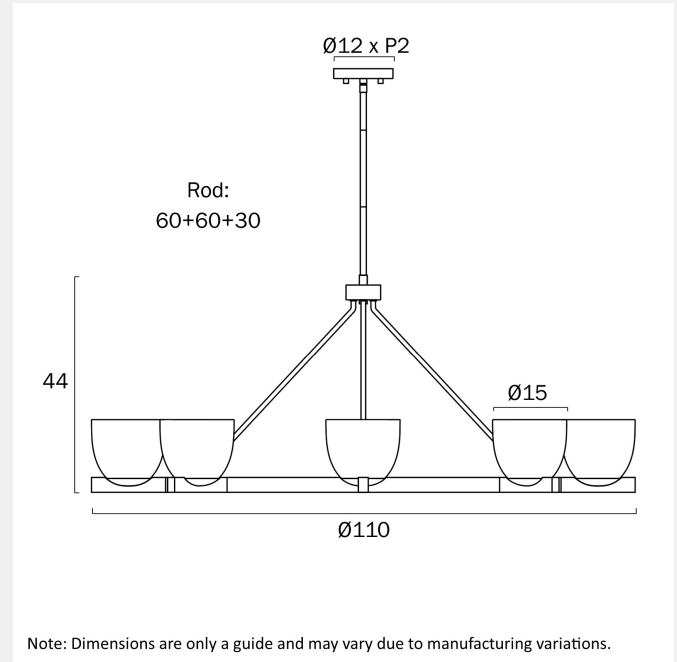

LIGHT SOURCE

Voltage Input

240V

Total Wattage (max)

200

Globe Type

E14

Globe / Light Source qty

8

Globe / Light Source included

No

Dimmable

Globe dependant

SPECIFICATIONS

Lead and Plug

No

IP rating

IP20

Suspension Type

Rod (1x300)+(2x600)

Height Adjustable?

Yes

Raked Ceiling Compatible

No

Mounting

Surface

Electrical Protection

CLASS I - HIGH VOLTAGE, EARTH REQUIRED

COLOUR AND MATERIAL

Fixture Material

Iron, Glass

Glass Color

Clear

WARRANTY

Replacement Warranty

*3 Years

PRODUCT DIMENSIONS

Fixture Weight (Kg)

9

Fixture Height (cm)

44

Suspension Length (cm)

150

CARE

Care Instructions

Do not use strong liquid cleaners. Wipe clean with a dry cloth. Aluminium, Brass and Stainless Steel will naturally oxidise and change overtime. Exterior products require regular four (4) monthly cleaning and maintenance to ensure they do not accumulate dirt or other environmental deposits. Wipe the product with a mild detergent and warm water to remove surface deposits. Rinse with fresh water and wipe dry with a soft cloth. An extra temporary protection barrier of water displacement oil can help to maintain the surface, such as WD40, sprayed onto a soft cloth and rubbed onto the surface.

VARIANTS

[RADAM PE8-BK] RADAM 8
PENDANT LIGHT (BLACK)



9329501084694

[RADAM PE8-VB] RADAM 8
PENDANT LIGHT (VINTAGE
BRASS)



9329501084700

Find RADAM 8 PENDANT LIGHT on
www.telbix.com

