

Last modification 2024-02-16

## SEGOVIA WB-GD 9329501068519



### Overview

<b>Family name</b>	Segovia
<b>Categories</b>	Wall Lights
<b>Mounting</b>	Surface
<b>Shade Shape</b>	Round
<b>Usage</b>	Indoor Lighting
<b>ERAC Product Registration</b>	TUV15817EA

### Color / Material

<b>Fixture Color</b>	Gold, Clear
<b>Fixture Finish</b>	Gloss
<b>Fixture Material</b>	Glass, Stainless Steel, Zinc Alloy, Iron
<b>Canopy Color</b>	Gold
<b>Glass Color</b>	Clear

### Size

<b>Fixture Width (cm)</b>	9.0
<b>Fixture Height (cm)</b>	25.0
<b>Fixture Projection (cm)</b>	11.5
<b>Canopy Diameter (cm)</b>	11.0
<b>Glass Diameter</b>	9.00
<b>Glass Height (cm)</b>	9.0
<b>Height Adjustable?</b>	No

### Specification

<b>Voltage Input</b>	240V
<b>Total Wattage (max)</b>	5
<b>Globe Type</b>	LED integrated SMD
<b>Globe / Light Source qty</b>	1
<b>Globe / Light Source included</b>	Yes
<b>Lumens</b>	430
<b>Color Temperature</b>	Warm White
<b>Color Kelvin</b>	3000k

All representations within this document are subject to copyright. ELECTRICAL INSTALLATIONS MUST BE PERFORMED BY A QUALIFIED ELECTRICAL CONTRACTOR AND INSTALLED IN ACCORDANCE WITH AS/NZS 3000.  
NOTE : All images , descriptions and dimensions are indicative. Please check latest version of item detail on Telbix website prior to ordering or installation.

<b>Color Rendering</b>	>80
<b>Dimmable</b>	No
<b>Electrical Protection</b>	CLASS I - HIGH VOLTAGE, EARTH REQUIRED
<b>IP rating</b>	IP20
<b>Lead and Plug</b>	No
<b>Approvals</b>	RCM
<b>Box Contents</b>	Instruction, Basic mounting screws
<b>Installation Required</b>	Yes (by Licensed Electrician only)
<b>Care Instructions</b>	Do not use strong liquid cleaners, Wipe clean with a dry cloth
<b>Replacement Warranty</b>	*3 Years

## Barcode

GTIN 9329501068519

## Image -dimensions

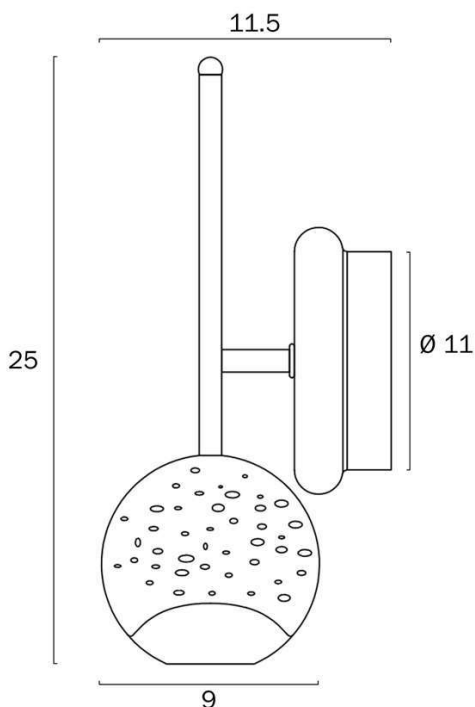

Note: Dimensions are only a guide and may vary due to manufacturing variations.