

Last modification

2022-10-13

## RANA PE40-NAT 9329501063989



### Overview

<b>Family name</b>	Rana
<b>Categories</b>	Pendants
<b>Mounting</b>	Surface
<b>Suspension Type</b>	Cable
<b>Usage</b>	Indoor Lighting

### Color / Material

<b>Fixture Color</b>	Natural,White
<b>Fixture Material</b>	Rattan,Iron
<b>Canopy Color</b>	White
<b>Cable Color</b>	White
<b>Cable Material</b>	PVC

### Size

<b>Fixture Diameter (cm)</b>	40.0
<b>Fixture Height (cm)</b>	43.0
<b>Canopy Diameter (cm)</b>	10.0
<b>Canopy Projection (cm)</b>	2.5
<b>Suspension Length (cm)</b>	150.0
<b>Height Adjustable?</b>	Yes

### Specification

<b>Voltage Input</b>	240V
<b>Wattage (max)</b>	25
<b>Globe Type</b>	E27
<b>Globe / Light Source qty</b>	1
<b>Globe / Light Source included</b>	No
<b>Dimmable</b>	Globe Dependant
<b>Electrical Protection</b>	CLASS I - HIGH VOLTAGE, EARTH REQUIRED
<b>IP rating</b>	IP20
<b>Approvals</b>	RCM
<b>Box Contents</b>	Basic mounting screws,Instruction

All representations within this document are subject to copyright.ELECTRICAL INSTALLATIONS MUST BE PERFORMED BY A QUALIFIED ELECTRICAL CONTRACTOR AND INSTALLED IN ACCORDANCE WITH AS/NZS 3000.  
NOTE : All images , descriptions and dimensions are indicative. Please check latest version of item detail on Telbix website prior to ordering or installation.

<b>Installation Required</b>	Yes (by Licensed Electrician only)
<b>Care Instructions</b>	Do not use strong liquid cleaners,Wipe clean with a dry cloth
<b>Replacement Warranty</b>	*3 Years

Barcode

**GTIN** 9329501063989

Image -dimensions

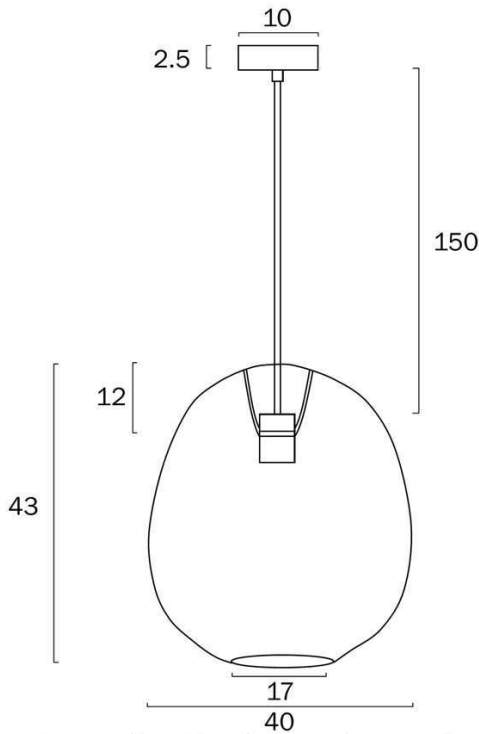

Note: Dimensions are only a guide and may vary due to manufacturing variations.

