

LED TRACK LIGHTS

Suitable for use in convention centres, business centres, offices, hotels, museums, hospitals, boutiques, homes and leisure spaces, etc.



Product Features:

- Interior LED track heads
- Input voltage range: 220-240V AC 50/60Hz
- Housing: polycarbonate gear box, die-cast aluminium
- On/off switch on head to switch individually
- LED chips: Edison HM24 COB LED
- Power factor: 0.9
- CRI: >80
- Suitable for dimming, triac dimmable driver included
- Track can be hung from ceiling with suspension cable (Not included in CLA range)

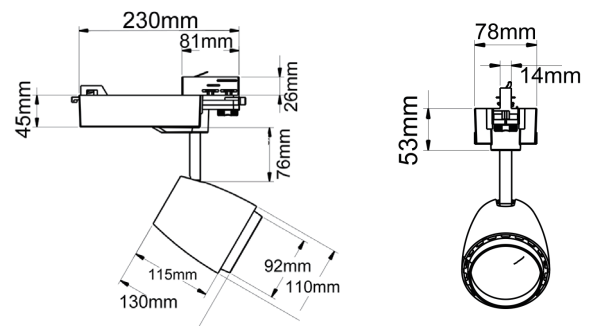

 30,000hr Lifetime	 35° Beam Angle	 IP20 Rated	 3YEAR Replacement Warranty
--	---	---	--

Tested & Recommended Dimmers:

Brand	Part No.	PCS per Dimmer
CLA - Trailing Edge	LYNX	1-3pcs
Clipsal - Universal	32E450UDM	
Clipsal - Universal	32E450TM	
HPM - Trailing Edge	CAT400T	

Part No.	Description	Kelvin	Lumens	Watt	CRI	Carton QTY
TRKBLHDW	4 WIRE 3 Circuit LED TRACK HEAD BLK	3000K	2172lm	30W	>80	1/8
TRKBLHDN	4 WIRE 3 Circuit LED TRACK HEAD BLK	5000K	2242lm	30W	>80	1/8
TRKWHDW	4 WIRE 3 Circuit LED TRACK HEAD WH	3000K	2172lm	30W	>80	1/8
TRKWHDN	4 WIRE 3 Circuit LED TRACK HEAD WH	5000K	2242lm	30W	>80	1/8

4 WIRE/ 3 CIRCUIT TRACK & ACCESSOIRES

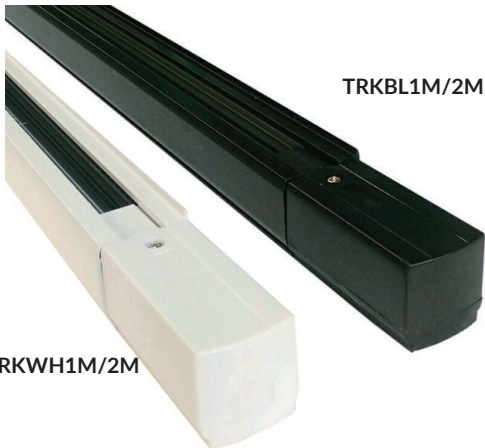

TRKBL1M/2M

TRKWH1M/2M



Track can be hung from ceiling with suspension cable
(Not included in CLA range)



TRKBLCN1

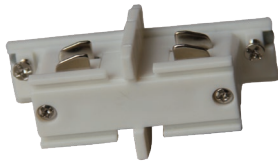

TRKWHCN2



TRKBLCN3

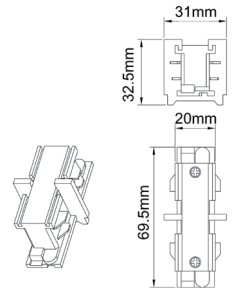
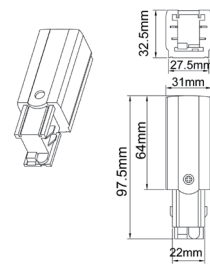

TRKWHCN4



TRKBLCNL



TRKBLKENDCAP

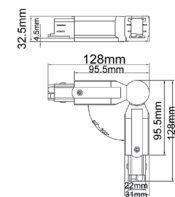
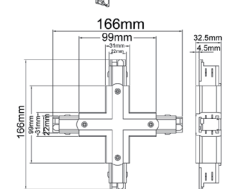
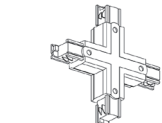
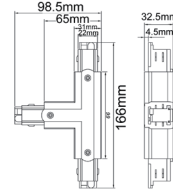
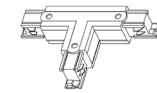

Part No.	Description	Carton QTY
TRKBLKENDCAP	4 WIRE 3 Circuit TRACK DEAD END CAP FOR TRK SERIES BLACK	1/50
TRKBL1M	4 WIRE 3 Circuit TRACK 1M BLK (incl LIVE TRKBLCN1 & DEAD END TRKBLKENDCAP)	1/20
TRKBL2M	4 WIRE 3 Circuit TRACK 2M BLK kit (incl LIVE TRKBLCN1 & DEAD END TRKBLKENDCAP)	1/20
TRKBLCN1	4 WIRE 3 Circuit TRACK LIVE END CAP BLK	1/196
TRKBLCN2	4 WIRE 3 Circuit TRACK CONNECTOR BLK	1/200
TRKBLCN3	4 WIRE 3 Circuit TRACK T-PIECE JUNCTION BLK	1/56
TRKBLCN4	4 WIRE 3 Circuit TRACK CROSS-PIECE JUNCTION BLK	1/42
TRKBLCN5	4 WIRE 3 Circuit TRACK Straigh Joiner with Live Connection BLK	1/100
TRKBLCNL	4 WIRE 3 Circuit TRACK 90 D ELBOW JOINER BLK	1/75
TRKWHEENDCAP	4 WIRE 3 Circuit TRACK DEAD END CAP FOR TRK SERIES WHITE	1/50
TRKWH1M	4 WIRE 3 Circuit TRACK 1M WH (incl LIVE TRKBLCN1 & DEAD END TRKBLKENDCAP)	1/20
TRKWH2M	4 WIRE 3 Circuit TRACK 2M WH kit (incl LIVE TRKBLCN1 & DEAD END TRKBLKENDCAP)	1/20
TRKWHCN1	4 WIRE 3 Circuit TRACK LIVE END CAP WH	1/196
TRKWHCN2	4 WIRE 3 Circuit TRACK CONNECTOR WH	1/200
TRKWHCN3	4 WIRE 3 Circuit TRACK T-PIECE JUNCTION WH	1/56
TRKWHCN4	4 WIRE 3 Circuit TRACK CROSS-PIECE JUNCTION WH	1/42
TRKWHCN5	4 WIRE 3 Circuit TRACK Straigh Joiner with Live Connection WH	1/100
TRKWHCNL	4 WIRE 3 Circuit TRACK 90 D ELBOW JOINER WH	1/75