



UFO SHB23SE - 80/180W

Multi-purpose LED highbay or lowbay IP65 with HIGH optical performance 180lm/W

Application

Versatile LED highbay or lowbay, ideal for commercial and industrial applications

Design Specifications

- High optical performance 180lm/W, standard beam 90°, clear polycarbonate diffuser
- CRI > 70, CCT 5000K, high performance LED chips
- Robust die-cast aluminium body profile complete with UV rubber, flex and plug
- Versatile range of interchangeable accessories to accommodate various mounting applications, optional corridorSTANDBY and Daylight harvesting sensor accessories available for internal applications
- Integral 1-10V dimmable control gear with 4KV surge protection, 80 - 180 watt models.



Performance

Dimmable - **YES**

Dimmer Type - **1-10V**

Technical Specification

Model No.	Input Voltage (V/AC)	Power (W)	Lumens (lm)	CCT (K)	Beam Angle (°)	CRI
SHB23SE100NDL	240	80	14400	5000	90	70
SHB23SE150NDL	240	120	21600	5000	90	70
SHB23SE200NDL	240	180	32400	5000	90	70
SHB23SE/CS						

Model No.	Body Colour	Dim (mm)	Mass (kg)	iPART	VEET
SHB23SE100NDL	BLACK	260(W) x 198(H)	2.2	YES	YES
SHB23SE150NDL	BLACK	280(W) x 198(H)	2.5	YES	YES
SHB23SE200NDL	BLACK	300(W) x 198(H)	2.9	YES	YES
SHB23SE/CS	STANDBY SENSOR				

Note: Sensor default settings: Sensitivity=100%, Hold Time=30mins, StandBy power=30%, StandBy time 30mins, Daylight Threshold=disabled

Due to continued product and technology enhancements, data sourced from sal.net.au shall not form part of any contract and or technical performance guarantee unless expressly confirmed in writing by SAL at the time of order. Products are sold in accordance with [SAL Terms and Conditions of sale](#) and all images shown are for illustration purposes only and may vary from the actual colour or finish. Unless specifically stated, all IP ratings nominated for Interior products are from "below the ceiling".

Dimensions

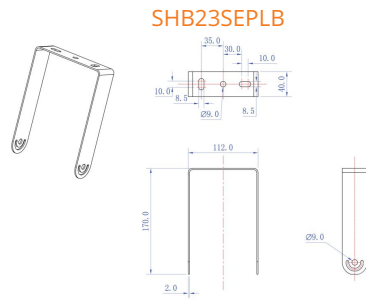
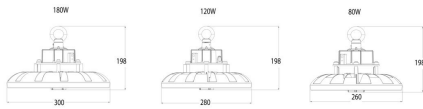

SHB23SE100NDL - ACCESSORIES

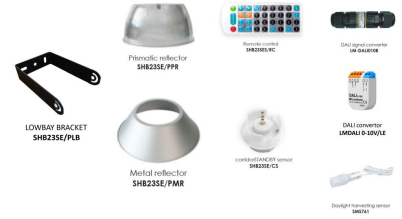

SHB23SE150NDL - ACCESSORIES



SHB23SE200NDL - ACCESSORIES

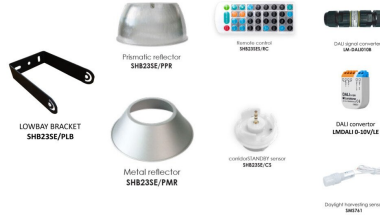

Photometric Data

Photometric Data

Unit: cd C0/C180 — C90/C270

SHB23SE100NDL at 5000K

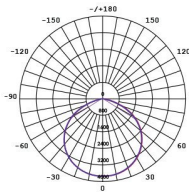

SHB23SE150NDL at 5000K

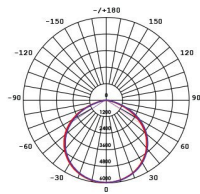

SHB23SE/CS

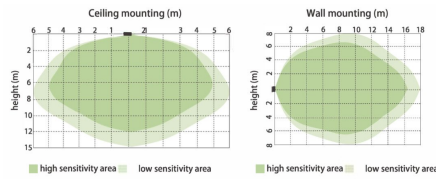

THE NEW ESS106 IS SMALL IN SIZE BUT BIG ON FEATURES.



For more
information
please
scan me

