

LED RECESSED WALL LIGHT

SE7140 LOUVERED

SE7141 SLOT

SE7142 PLAIN

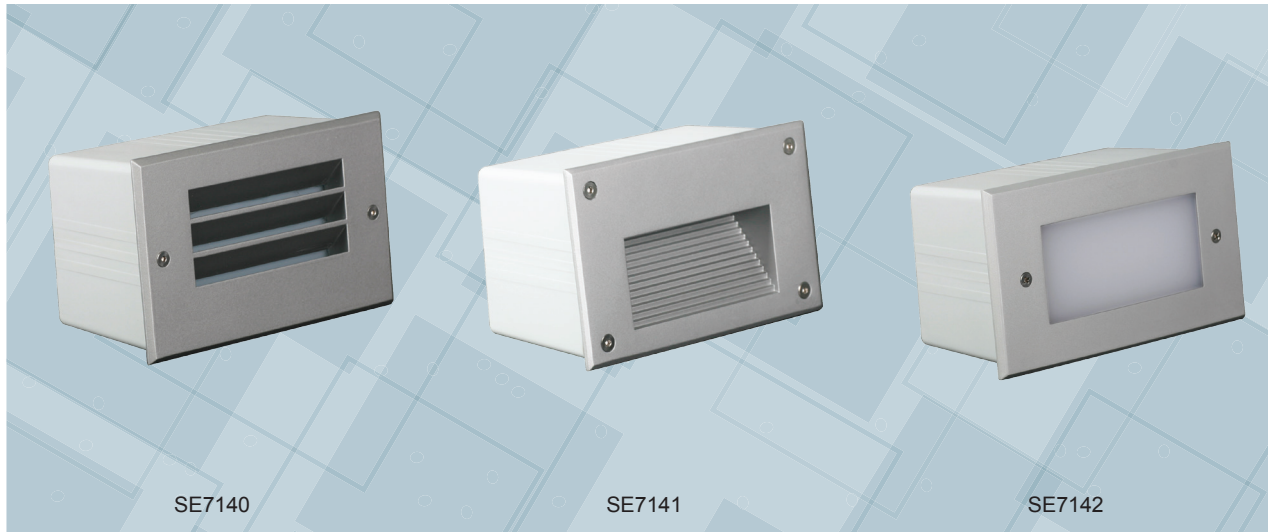

DIMENSIONS



Installation canister: L 158 mm x W 84 mm

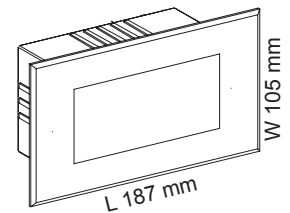
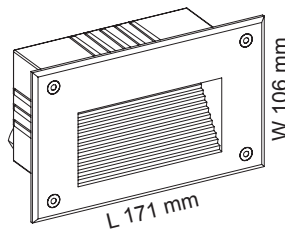
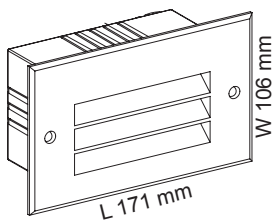
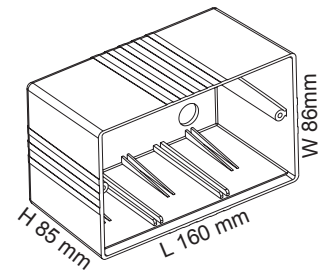
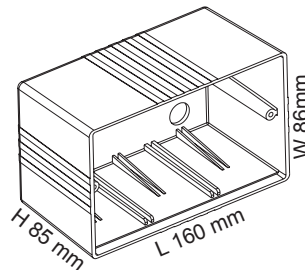
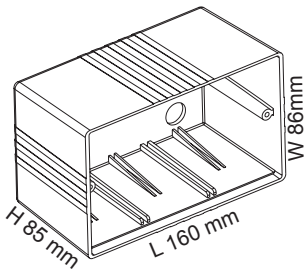

CONSTRUCTION

- Die-cast aluminium body and face cover
- Powder coated finish
- Opal polycarbonate diffuser
- High efficiency SMD LED chips
- Built in non-dimmable LED driver

- Silicone gasket
- IP67 nickel coated copper cable gland
- Stainless steel allen screws
- PVC installation canister included

IP RATING

- IP65 weatherproof



CANISTER INSTALLATION INSTRUCTIONS

- A1 & A2 are the support plates used during the construction installation process to prevent deformation of the installation canister
- Slot in A1 & A2 plates during construction
- Please remove the support plates (A1 & A2) before final installation

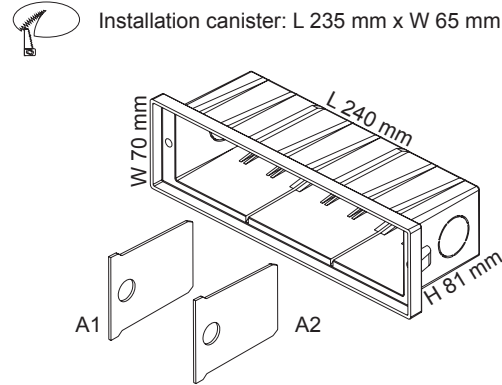

Model No.	Input	Power	Lumen	CCT	CRI	Fitting Colour
SE7140WW/BK	240V	3W	50lm	3000K	>80	Black
SE7140WW/SL	240V	3W	50lm	3000K	>80	Silver
SE7140CW/BK	240V	3W	50lm	4000K	>80	Black
SE7140CW/SL	240V	3W	50lm	4000K	>80	Silver

Model No.	Input	Power	Lumen	CCT	CRI	Fitting Colour
SE7141WW/BK	240V	3W	60lm	3000K	>80	Black
SE7141WW/SL	240V	3W	60lm	3000K	>80	Silver
SE7141CW/BK	240V	3W	60lm	4000K	>80	Black
SE7141CW/SL	240V	3W	60lm	4000K	>80	Silver

Model No.	Input	Power	Lumen	CCT	CRI	Fitting Colour
SE7142WW/BK	240V	3W	80lm	3000K	>80	Black
SE7142WW/SL	240V	3W	80lm	3000K	>80	Silver
SE7142CW/BK	240V	3W	80lm	4000K	>80	Black
SE7142CW/SL	240V	3W	80lm	4000K	>80	Silver

PHOTOMETRIC DATA Unit: cd C0/C180 — C90/C270

SE7140

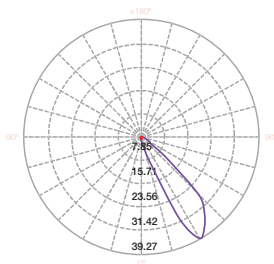

SE7141

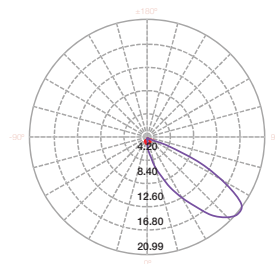

SE7142

