

## Zoom-Pro 5 LED Spike light



### Description

ZOOM-PRO 12W LED Garden Spike Light Series offers a range of different lighting effects in the one box. Simply push the button on the fitting to change colour temperatures. Or simply add the cover cap for low glare applications. Featuring a high output 12W LED chip, 40-degree beam angle, 150-degree tilt adjustable head and a black powder coated frame. Low voltage 12V/24V DC LED driver required. Complete with 3 metre round rubberised cable and water stopper for added protection from moisture entering the head unit. Backed by a 3 Year Replacement Warranty.

### Specification Features

Input Voltage:	12V/24V DC
Power (W):	5W
IP rating (IP):	67
Lumens (lm):	Warm White 3000K - 320lm Neutral White 4000K - 360lm White 5000K - 360lm
LED type:	COB
CCT:	3000K - 4000K - 5000K (Switchable)
CRI:	≥80
Beam angle (°):	40°
Dimmable:	No
Lifespan (hrs):	30,000hrs

12V/24V DC LED Driver required



Water Stop Cable Joint



### Diagrams / Additional

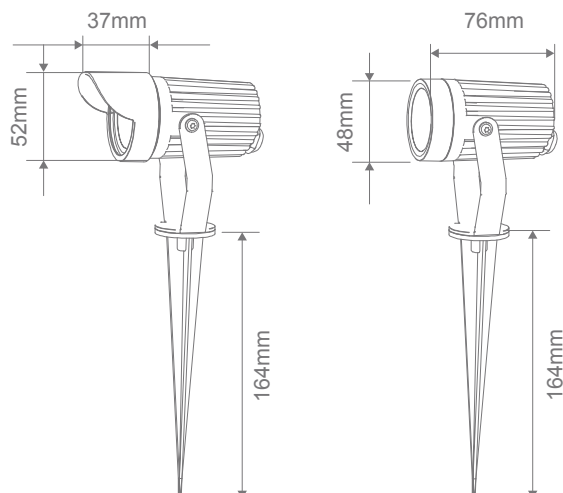

Item No.	Variant	CCT
ZOOM-PRO-5	25702	TRIO